

Waterdrop

Instruction Manual

Read and save these instructions

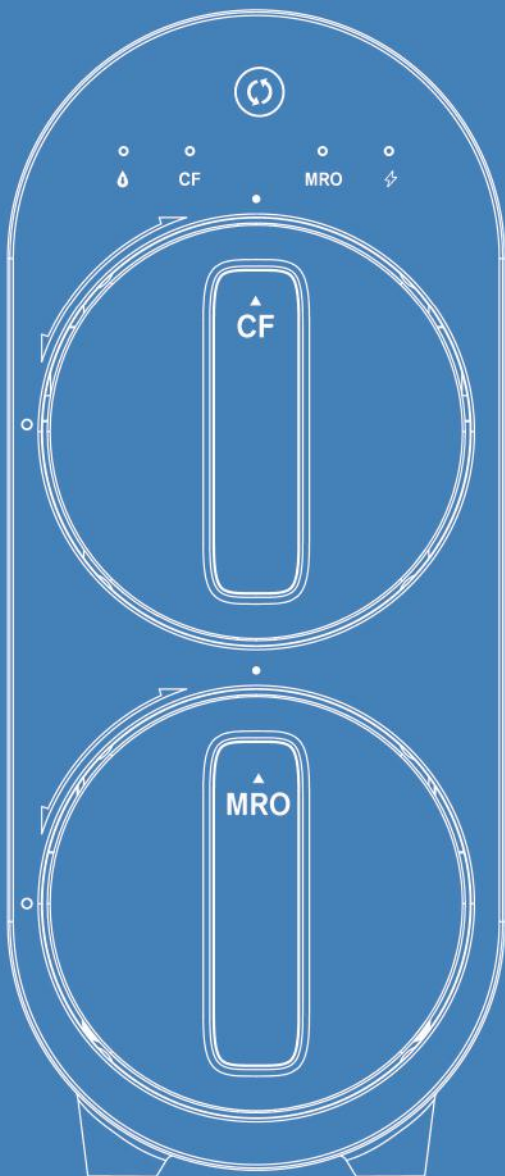

RO

Reverse Osmosis
Water Filtration System

Find the installation video

Search “Waterdrop G2 undersink RO installation” on  YouTube

Register 1-year manufacturer warranty*

Visit warranty.waterdropfilter.com
and enter the product serial number:

Any questions, please contact us.

✉ service@waterdropfilter.com

☎ 1-888-352-3558 Mon-Fri 8:00 AM-5:00 PM (PST)

🌐 www.waterdropfilter.com (live chat available)



- This appliance can be used by children aged from 8 years and above and persons with reduced physical, sensory or mental capabilities or lack of experience and knowledge if they have been given supervision or instruction concerning use of the appliance in a safe way and understand the hazards involved.

- Children shall not play with the appliance.
- Cleaning and user maintenance shall not be made by children without supervision.
- The appliance is only to be used with the unit provided.

Disposal



Dispose of the packaging material in an environmentally friendly manner so that it can be recycled.



The device is governed by the European Directive 2012/19/EU on waste electrical and electronic equipment (WEEE). Do not dispose of the device as normal domestic waste, but rather in an environmentally friendly manner via an officially approved waste disposal company.



Contents

Installation Instructions

Before Installation	1
Parts List	2
Product Introduction	3
Installation Tips	4
Installation Steps	5
Step 1: Install the Feed Water Adapter	5
Step 2: Install the RO Faucet	6
Step 3: Install the Drain Saddle	7
Step 4: Position the RO System Housing	7
Step 5: Connect Tubing	8
Step 6: Start up the System	9

Owner's Manual

Display and Operation	10
Section 1: Working Mode Display	10
Section 2: Filter Life Reminder	10
Section 3: Filter Replacement Guide	11
Section 4: Malfunction Display	13
System Maintenance	13
Troubleshooting	14
Limited Product Warranty	16

Installation Instructions

Before Installation

Inspect the Package

Open the box and take out the system housing, all the components and quick-connect fittings. Inspect them according to the parts list to ensure nothing is left out or damaged during shipping. If there are any parts cracked or broken, please do not proceed with the installation and contact Waterdrop by phone: 1-888-352-3558 Mon-Fri 8:00 AM-5:00 PM (PST) or by live chat: waterdropfilter.com. Identify and get familiar with all components for quick installation.

Required Tools

- Variable speed drill
- Drill bit: 1/4" (for drainpipe), 1" (for faucet hole)
- Adjustable wrench, pliers
- Screwdriver
- Utility knife or scissors
- Flashlight
- Towel

Specifications

To achieve the optimal performance, it is highly recommended to use the system within the operational parameters.

Model	WD-G2-B / WD-G2-W WD-G2P600-B / WD-G2P600-W
RO System Size (L*W*H)	17.3" * 5.9" * 14.0"
Feed Water Pressure	14.5-87 psi / 0.1-0.6 MPa
Feed Water Temperature	41-100 °F / 5-38 °C
Feed Water Requirement	Municipal Tap Water
Max Daily Production Rate	400 GPD / 600 GPD
Power Specification	Input 110~240V AC
	Output 24V DC
Rated frequency	50/60Hz
Rated current	4A

NOTE:

- The daily production rate is measured under 30 psi dynamic feed water pressure and 77 °F water temperature.
- If you are using well water as the source, please ensure that the feed water has been through a pre-filtration system.

Parts List

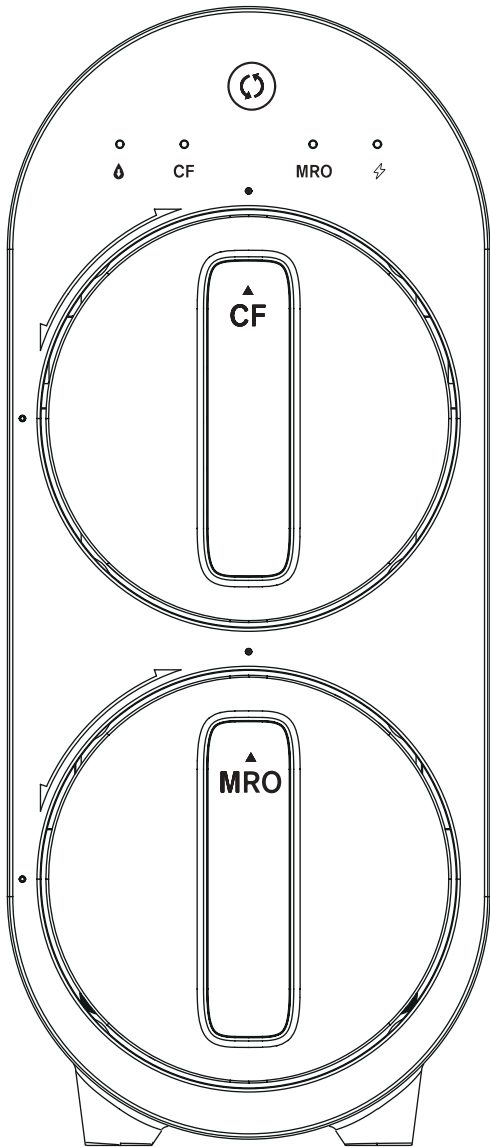

RO System
X 1 Set

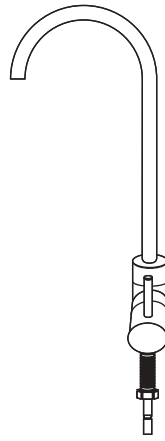

RO Faucet
X 1 Set

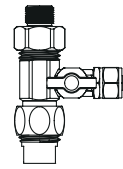

Feed Water Adapter
3/8" and 1/2"
X 1 Set

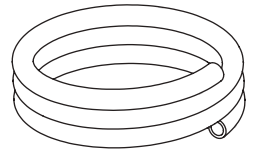

White 3/8"
PE Tubing
X 59"

—Preinstalled—

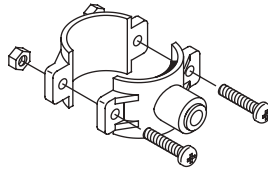

Drain Saddle 1/4"
X 1 Set

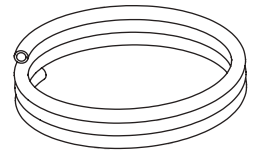

White 1/4" PE Tubing
X 59"

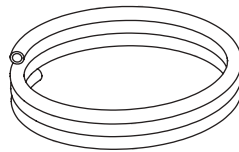

Red 1/4" PE Tubing
X 59"

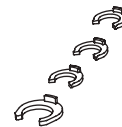

Lock Clip
X 4

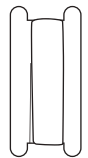

Teflon Tape
X 1

Product Introduction

The brief introduction of various parts and sample connections are presented as follows.

Please identify and get familiar with these parts and connection points for a smooth installation.

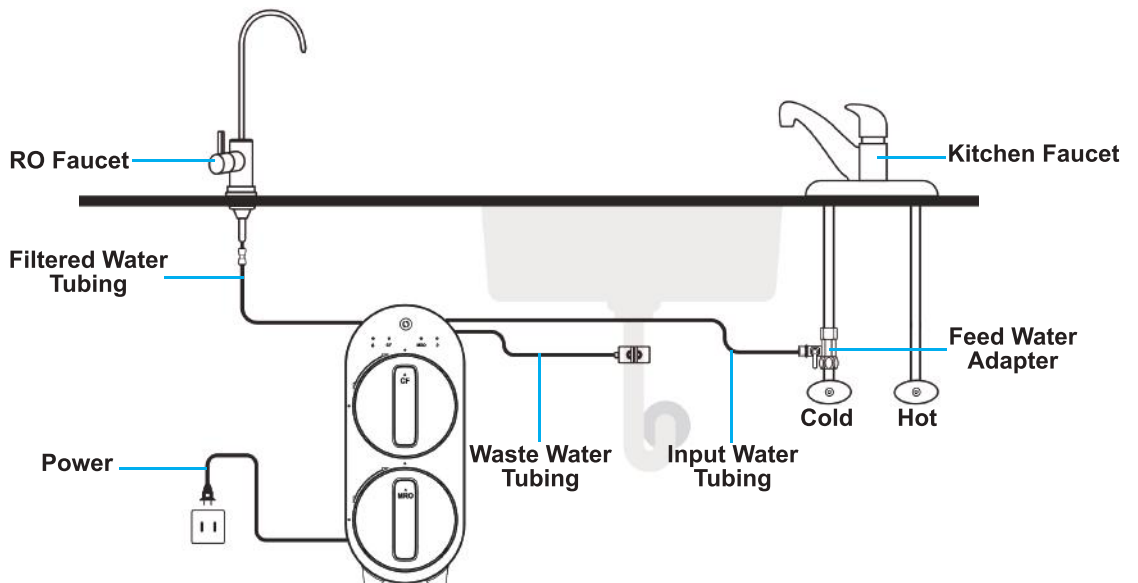
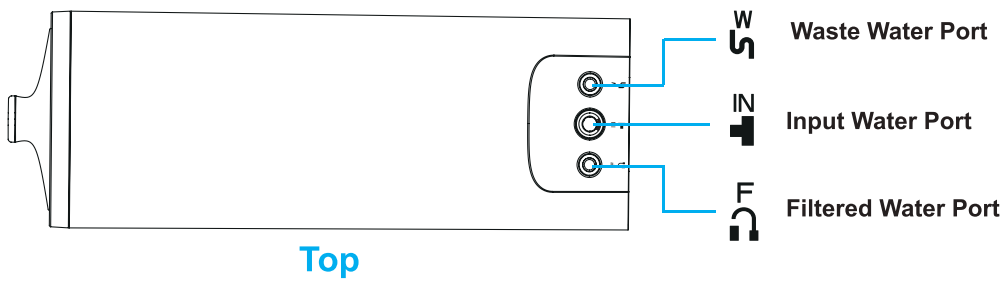
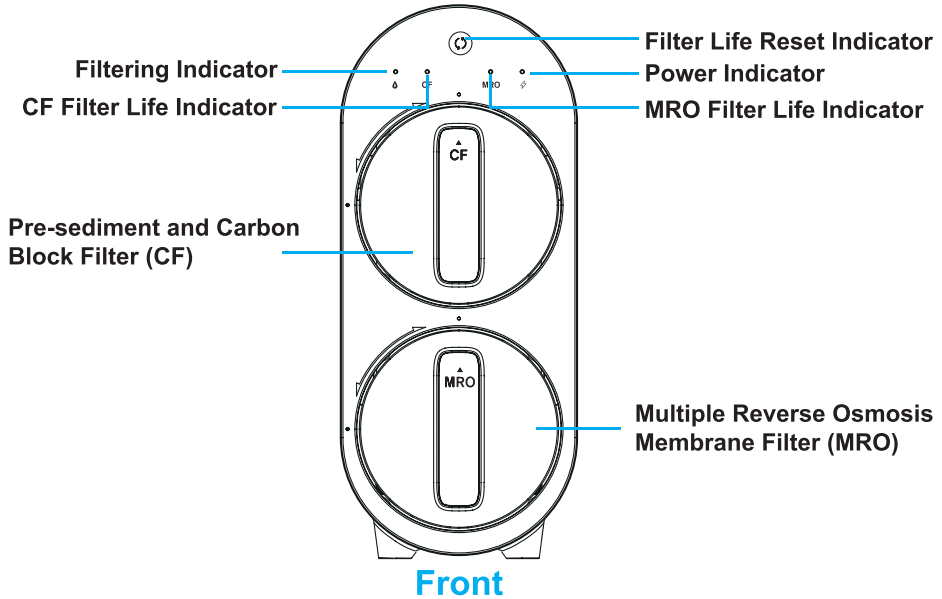

Installation Tips

How to Use the Quick-Connect Fittings

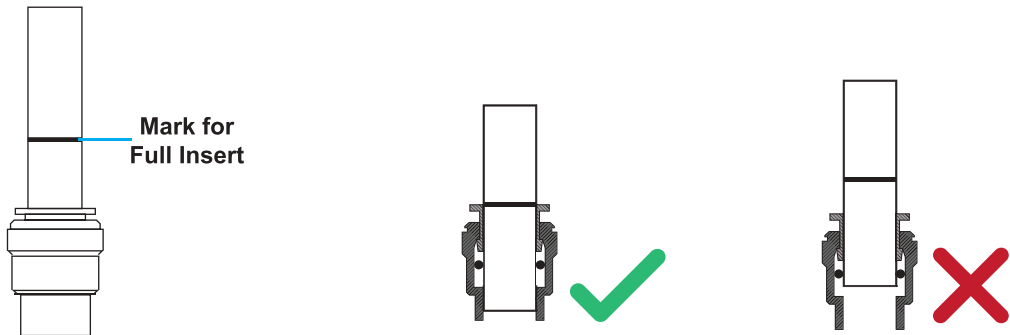

To connect:

- Push the tubing into the fitting until you reach the mark on the tubing.
NOTE: If the tubing is not fully inserted, it will cause leakage.
- When the tubing is fully inserted, put the blue lock clip on the fitting. It will lock the tubing in place and prevent it from falling off.

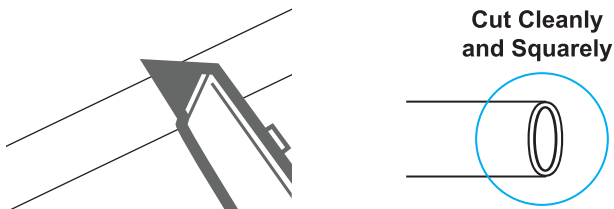

Figure 1

NOTE: If the tubing is too long, cut it to a suitable length with a sharp utility knife or scissors. Cut the tubing squarely and cleanly (Figure 1). Make sure the tubing is fully inserted (about 0.8”).

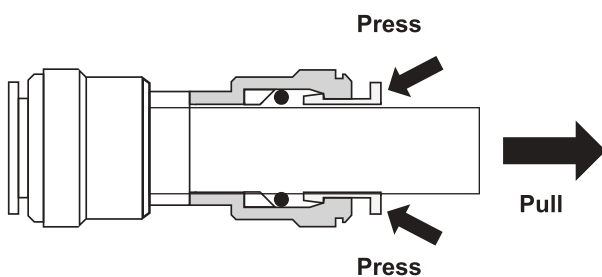

Figure 2

To disconnect:

- Remove the blue lock clip from the fitting;
- Use your thumb and index finger to press down on the lock sleeve. Use your other hand to pull out the tubing from the fitting (Figure 2).
NOTE: Please do not pull out the tubing directly, or else it will damage the fitting and cause leakage.

How to Drill a Hole into Your Sink or Countertop (Optional)

NOTE: Please confirm if there is an existing hole available to install the RO faucet. If not, please drill a hole in accordance with the following steps. It's highly recommended to watch the YouTube video "How to Drill Faucet Holes" for better understanding of the process. There is also a sticker for your reference to drill the hole. Remember to wear safety glasses to protect your eyes while drilling the faucet hole.

1. Choose a diamond core bit for granite, and a carbide drill bit for stainless steel. Do not use a hammer drill on natural stone, glass or ceramic;
2. Glue the sticker to your sink or countertop, and drill a hole referring to the size shown on the sticker (1");
3. Make an indent with a center punch on a stainless steel sink before drilling to help guide the bit;
4. Be careful when drilling on a porcelain sink, as it can be easily chipped. Apply downward pressure firmly to the bit until breaking through the surface;
5. Starting at the lowest speed, hold the drill straight with firm pressure to prevent the bit from walking on the counter;
6. Once breaking through the surface, swirl the drill a little to apply pressure in a circle evenly.

Installation Steps

Prior to installation, it is highly recommended to watch the video "Waterdrop G2 under sink RO installation" on  YouTube.

NOTE:

- The RO system must be connected to the COLD water supply ONLY.
- Do not install the system in exposure to direct sunlight or harmful chemicals, nor any place where it may be damaged.
- Do not install the system near any heat source.
- Do not install the system outdoors.

Step 1: Install the Feed Water Adapter (3/8" or 1/2")

NOTE: The input water tubing has been attached to the feed water adapter for easy installation.

1. Shut off the water supply. Turn on the kitchen faucet to release the water pressure;
NOTE: Make sure the water has stopped running before proceeding to the next step. Get a towel or bucket to catch water.
2. Disconnect the cold water pipe from the cold water supply valve;
3. Twist the feed water adapter onto the cold water supply valve (with its washer) and tighten it with an adjustable wrench (Figure 3);
NOTE: If the cold water pipe is 1/2", unscrew the two converters from the feed water adapter firstly (Figure 4), then implement step 3.
4. Twist the cold water pipe (with its washer) onto the feed water adapter and tighten with an adjustable wrench.

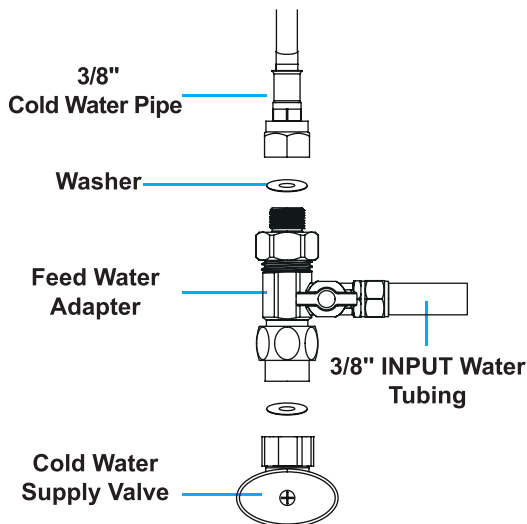

Figure 3

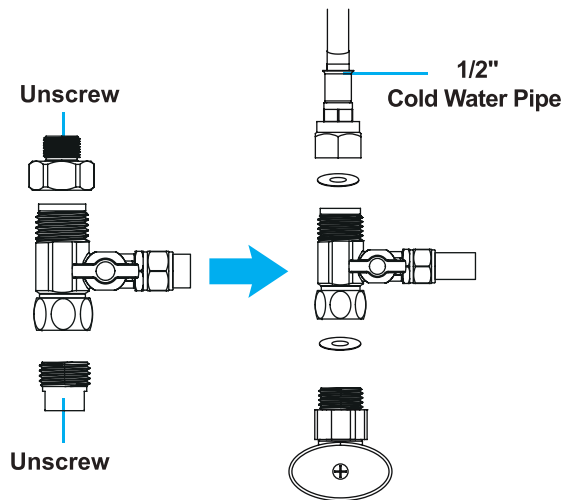

Figure 4

Step 2: Install the RO Faucet (Non-Air Gap Faucet)

NOTE: If there is no hole in your kitchen sink or countertop, you have to drill one (1") or use the hole in the soap dispenser. Refer to Page 5.

1. Insert the faucet spout into the faucet body;
2. Insert the faucet stem into the hole on the countertop;
3. Under the sink, slip on other parts in the order shown in the picture (Figure 5);
4. Insert the quick-connect fitting onto the faucet stem fully and firmly.

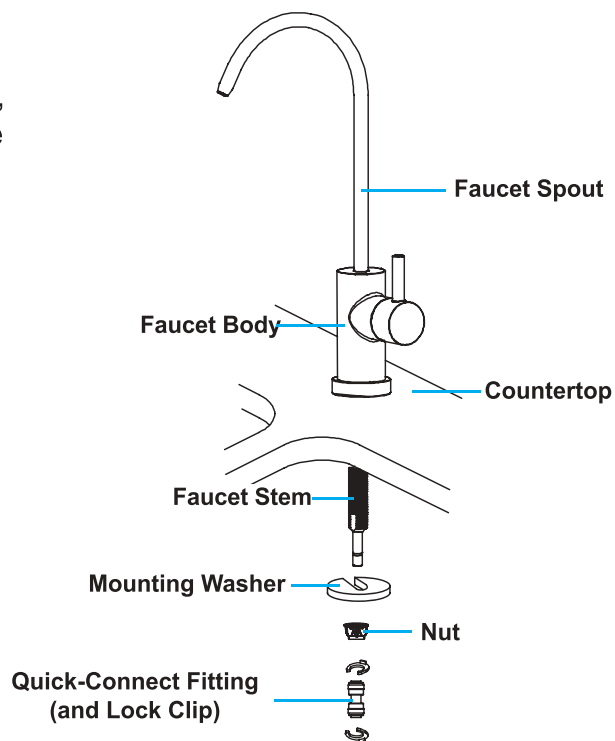

Figure 5

Step 3: Install the Drain Saddle

1. Choose a spot on the drainpipe that is convenient for installing the drain saddle and drill a 1/4" hole. Be sure not to penetrate the opposite side of the pipe;
NOTE: It's recommended to install the drain saddle on the vertical drainpipe.
2. Slip the front plate to one end of the tubing (without mark), and insert the tubing into the drilled hole up to about 0.6" (Figure 7);
3. Fix the drain saddle with screws and install the lock clip on the fitting to secure the connection (Figure 8);
NOTE: In some areas, the waste water tubing needs to be connected to the drainpipe through the air gap. Consumers need to purchase additional air gap accessories.

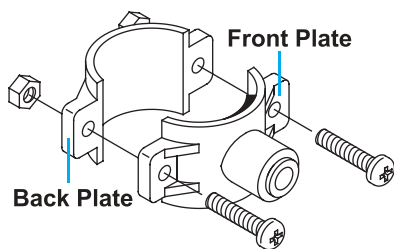

Figure 6

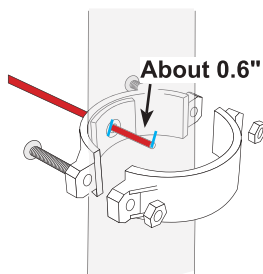

Figure 7

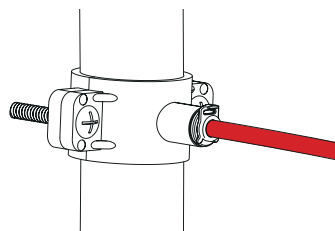

Figure 8

Step 4: Position the RO System Housing

Check and ensure there is sufficient space under the countertop to install the system (Figure 9).

NOTE: Make sure that there is a power outlet in the kitchen cabinet or on the wall connected to the lower cabinet space before installation.

It is not recommended to place the housing against the cabinet, as there may be vibrations when the system works.

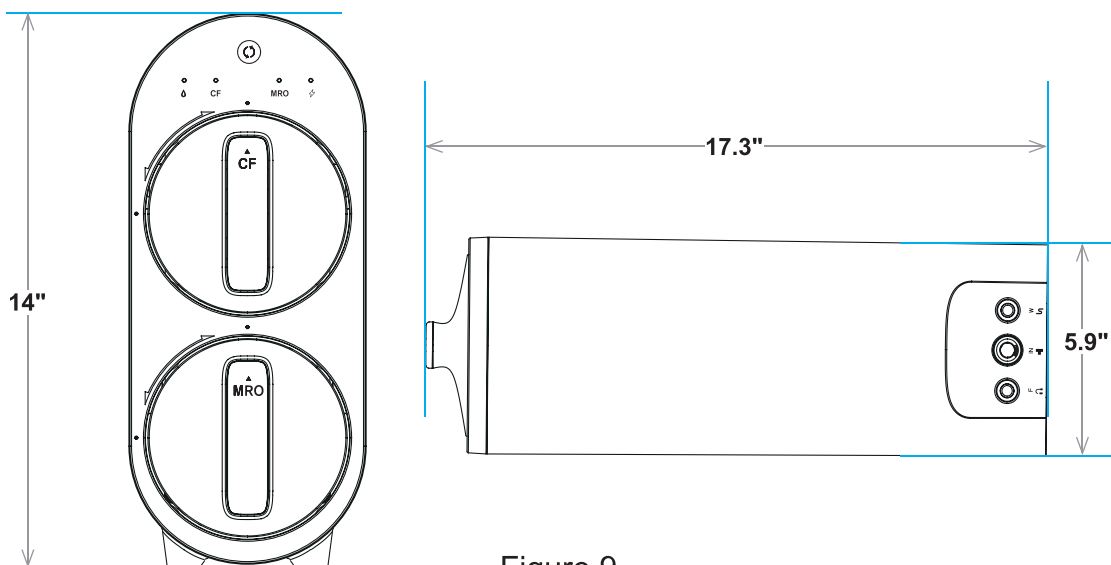

Figure 9

Step 5: Connect Tubing

NOTE: Confirm the tubing length you need and cut the tubing if it's too long, referring to "How to Use the Quick-Connect Fittings" on page 4.

1. Install the Input Water Tubing

- Connect the input water tubing from the feed water adapter to the "IN" input water port;

NOTE: Make sure it is fully inserted until you reach the mark on the tubing.

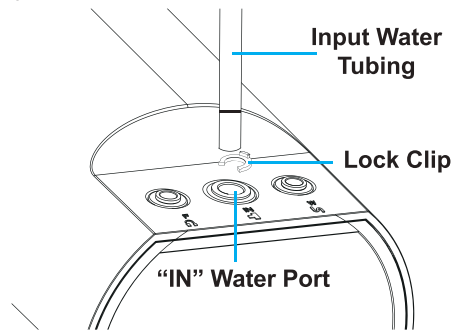
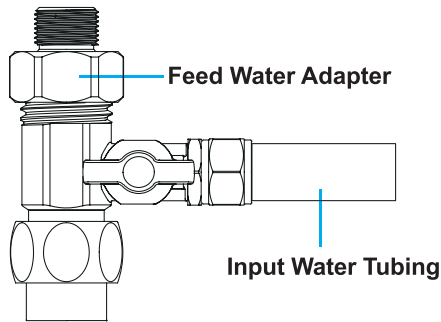

2. Install the Filtered Water Tubing

- Connect the filtered water tubing from the RO faucet to the "F" filtered water port;

NOTE: Make sure it is fully inserted until you reach the mark on the tubing.

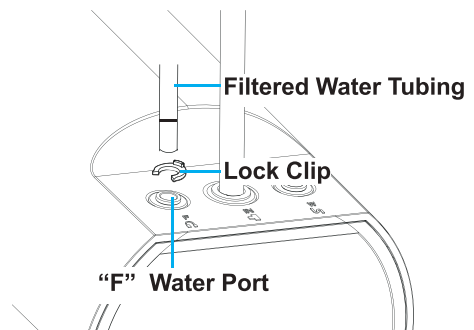
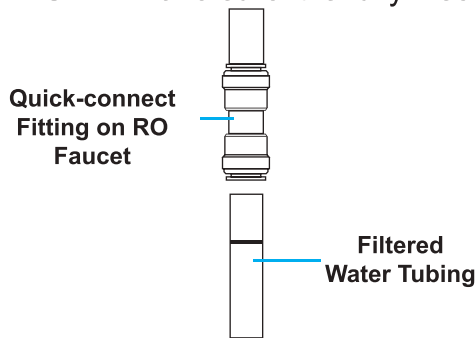

3. Install the Waste Water Tubing

- Connect the waste water tubing from the drain saddle to the "W" waste water port;

NOTE: Make sure it is fully inserted until you reach the mark on the tubing.

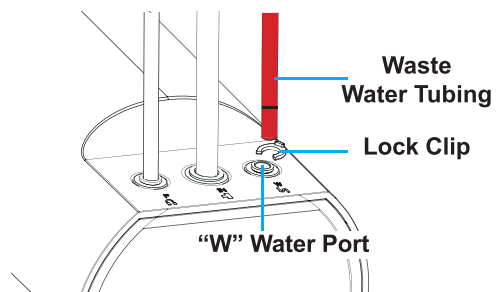
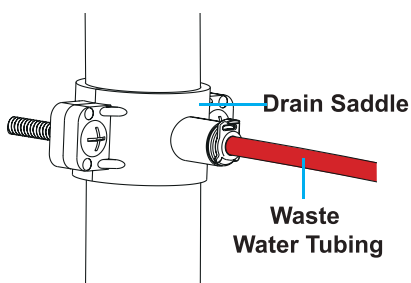

Step 6: Start up the System

1. Turn on the cold water supply valve. Check for leaks;
2. Insert the power plug into the socket;

NOTE: If the system can't be powered on after you insert the power plug, check the power under the sink, as this mostly occurs when the power under the sink is powered off. Also, check the connection between the power plug and the power outlet, and ensure that the system has been plugged correctly into the power outlet, as this may occur in a few cases. To test if there is a problem with the system itself, just pick up the system and try another power outlet. Please contact us if the system can't be powered on. We will help you figure it out.

NOTE: The system will beep. The filter life indicators will flash blue, purple and red in turn and then stay on blue for 3 seconds (Figure 10).

3. Turn on the faucet to let water run for 30 minutes until the filtering indicator on the front panel changes from flashing to permanent blue;
NOTE: Be sure to carefully check the tightness of each part of the system while flushing. Check and ensure all tubing is installed correctly and completely. Make sure there is no leaking at joints, fittings, valves and tubing connections.
NOTE: The water is undrinkable during flushing for consecutive 30 minutes. If the system stops flushing in advance, it will continue flushing when you turn on the RO faucet again, until reaching 30 minutes.
4. Confirm the 30-minute flushing is completed before turning off the RO faucet. Make sure the faucet does not leak.
5. Please fix the power adapter with the cable tie so that it does not move by impact. To avoid failure, stay away from any water sources, including pipe fittings, the bottom of the basement, and wet floors.

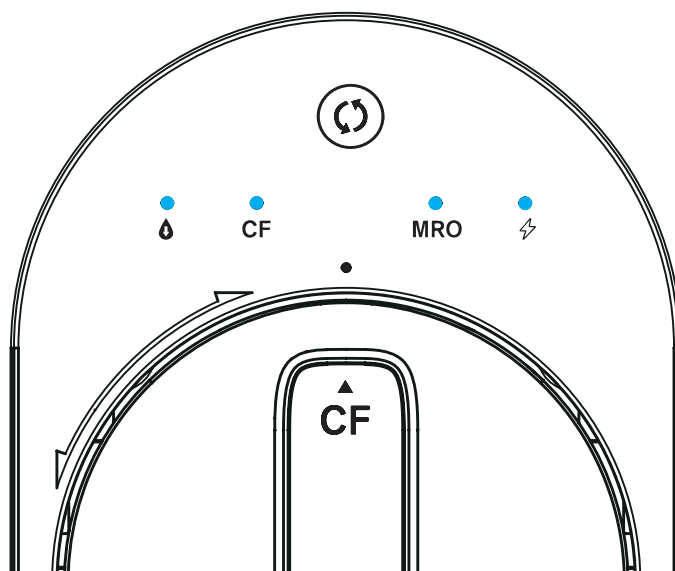

Figure 10

Owner's Manual

Display and Operation

Section 1: Working Mode Display

When making water, the filter and power indicators are permanent blue (Figure 11). Filter life indicators display in real time and their color depends on their life span. Filtering indicator is off when the system stops making water, and the rest of the indicators are still on (Figure 12).

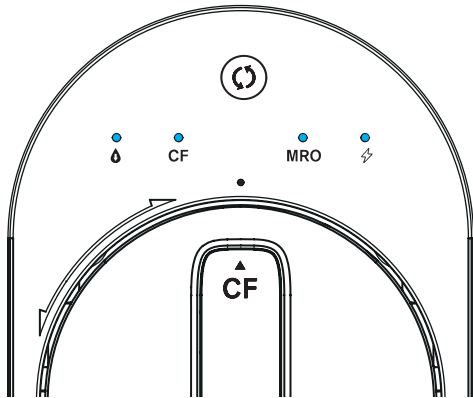

Figure 11

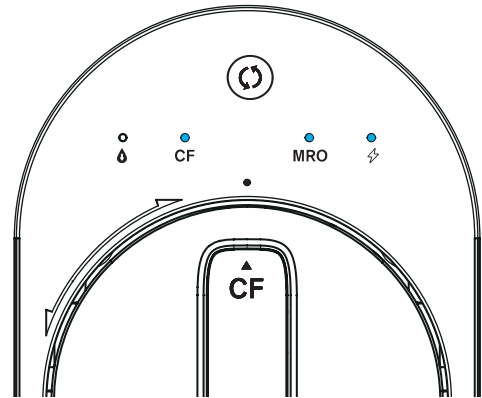
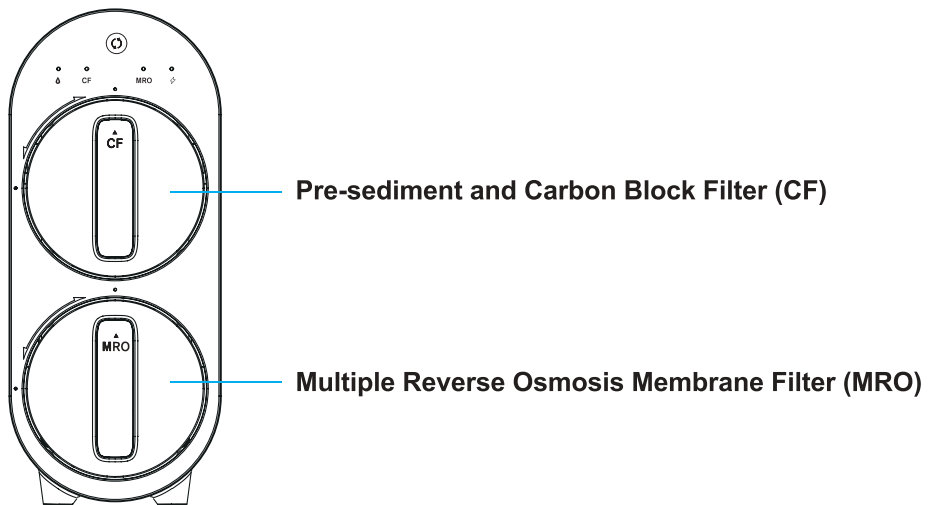

Figure 12

Section 2: Filter Life Reminder



NOTE: Filter life may vary depending on source water quality and water usage. Please replace the filter according to the reminder of the filter life indicators.

There are helpful electronic filter indicators (CF/MRO) on the front panel that will notify you to perform routine filter replacement by color change. Be sure to reset the filter life indicator every time you replace your filter.

Display Status:

Status	Remaining Life (Day)	Remaining Capacity (G)	Indication		Status
			Light	Buzzer	
Normal	>15	>40	Blue	N/A	Good
Pre-warning	≤15	≤40	Purple	Beeps 2 times when dispensing water	Replace Soon
Warning	≤0	≤0	Red	Keeps beeping when dispensing water	Replace Now

NOTE: The indicators will notify you according to the usage time or processing capacity of the filters, whichever comes first.

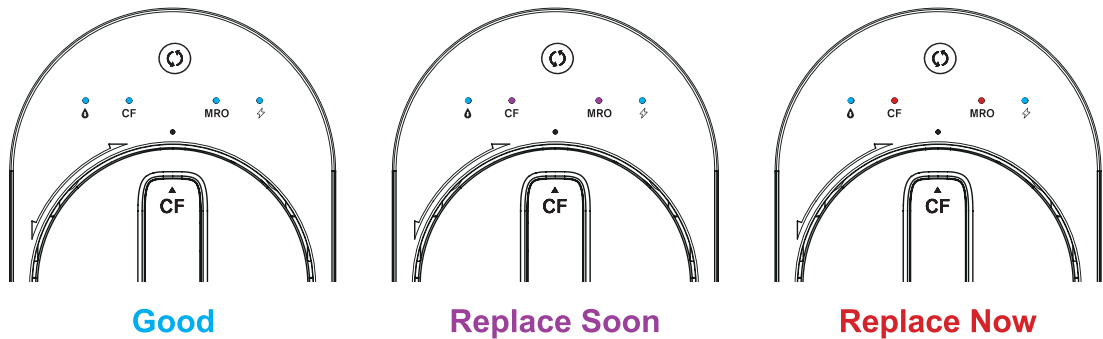

Section 3: Filter Replacement Guide

NOTE: If the filter expires, please purchase and replace the filter immediately. Otherwise, the filtration efficiency will decrease significantly and affect the performance.

How to Replace Filters:

The filters could be replaced directly without cutting off the power and water, and there will be no water and electric leakage.

1. Twist the filter that needs to be replaced counterclockwise (Figure 13);
NOTE: The CF filter is relatively short. When removing the filter, it is recommended to hold the filter with one hand, while rotating and removing the filter with the other hand, in order to prevent the filter from falling out of the system.
2. Remove wrappings and protective cap from the new filter;
3. Insert the filter into its corresponding hole, aligning the arrow with the empty circle on the housing;
4. Twist the filter with a little force forward in a clockwise direction for 90 degrees, until the arrow is aligned with the solid circle on the housing. You may hear a click when the filter is fitted into the place properly;
NOTE: Repeat the above steps to install the other filter.
5. Reset the filter life indicator and flush the filter after replacement (please refer to the following steps).

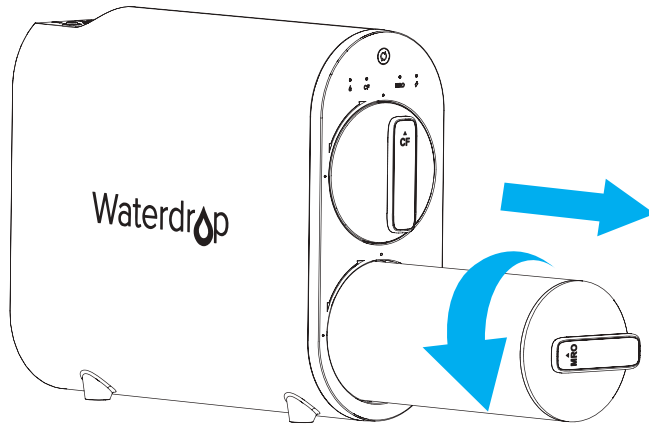

Figure 13

How to Reset the Filter Life Indicator:

1. Press the filter life reset indicator for 5 seconds (Figure 14). Release the indicator when you hear a beep. Now filters are ready to be reset;
2. Press the reset indicator and choose the CF filter or MRO filter (there is no need to choose if only one filter expired). The filter life indicator will flash when it is selected;
3. Press the reset indicator for 5 seconds again. The reset is completed when you hear a beep. The filter life indicator will be permanent blue.

NOTE: When the filter life indicator starts flashing, the system will stop resetting if there is no operation in 10 seconds.

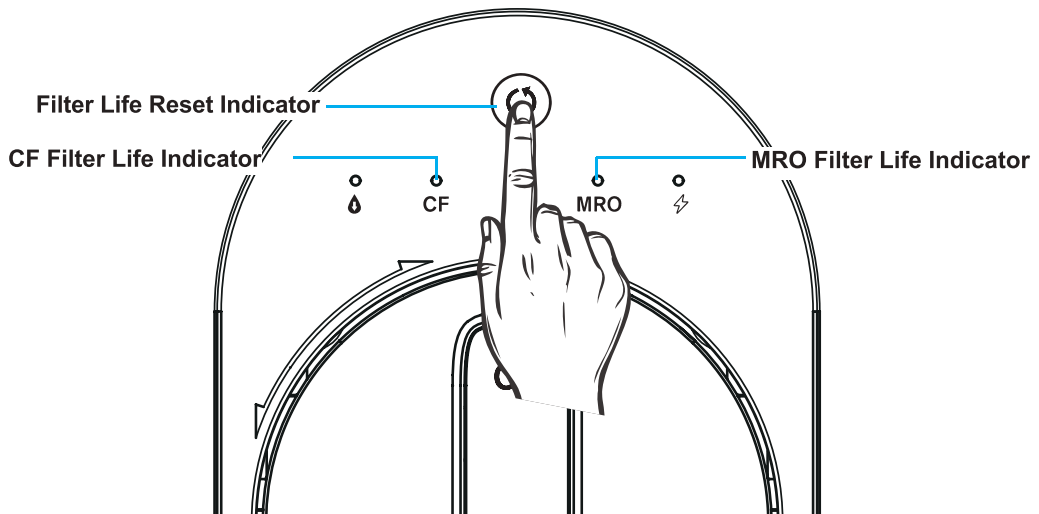

Figure 14

How to Flush the Filter After Replacement:

For the CF filter: Turn on the RO faucet to flush for 5 minutes;

For the MRO filter: Turn on the RO faucet to flush for 30 minutes.

NOTE: If you replace the CF filter and MRO filter at the same time, turn on the faucet to flush for 30 minutes. The filtering indicator is flashing during flushing. You can stop flushing until the filtering indicator changes from flashing to permanent blue.

Section 4: Malfunction Display

Overworked Reminder:

When the system continuously makes water for more than 30 minutes, the overworked reminder will be executed and the buzzer will beep for 3 minutes. The system stops making water when working for over 33 minutes, and the filtering indicator and power indicator are off. Meanwhile, the CF and MRO filter life indicators flash red. The system needs to be powered on again to recover itself.

Starting and Stopping Frequently Reminder:

The RO system will perform a starting and stopping frequently reminder when the booster pump is frequently started and stopped in 20 minutes. The system will stop making water, while the filtering indicator and power indicator are off and the CF and MRO filter life indicators flash purple. The system needs to be powered on again to recover itself.

System Maintenance

- If you do not use the machine for a long time (more than 1 week), it is recommended to turn on the faucet to flush for a while before using it again;
- Please replace the filter regularly according to the filter life indicator;
NOTE: While the testing was performed under standard laboratory conditions, actual performance may vary depending on the source water quality and water usage. In case of a premature blockage and failure of the filters, it's recommended to replace the filter in accordance with actual usage.
- Clean the system with clear water. Do not spray the water directly onto the filter. Do not use steel wool, an abrasive cleaner or a corrosive liquid such as gasoline or acetone;
- When cleaning, do not pour other liquids into the filter or you risk damaging the filter system;
- Keep the waste water pipe unobstructed to avoid damage to the filter or internal components;
- When the drainpipe is blocked, do not use the system (please turn off the power) to avoid the waste water from soaking the floor;
- Check the system and water pipe fittings regularly for water leakage to avoid any property damage;
- Regularly check whether the power supply and wires are damaged or loose to avoid major accidents caused by electric leakage.
- If you are using well water as the source, please ensure that the feed water has been through a pre-filtration system. Otherwise, large particles in the well water will easily clog the filter and shorten the filter life.

Troubleshooting

• If the System Cannot Be Powered on After You Insert the Power Plug

- a. Check the power under the sink, as this mostly occurs when the power under the sink is powered off. Also, check the connection between the power plug and the power outlet, and ensure that the system has been plugged correctly into the power outlet, as this may occur in a few cases.

To test if there is a problem with the system itself, just pick up the system and try another power outlet. Please contact us if the system can't be powered on. We will help you figure it out.

• No Output Water from RO Faucet

- a. Filter expires: Check the filter life indicators to confirm which filter needs to be replaced and replace it immediately.
- b. Low water pressure: Check and confirm the water pressure is between 14.5 psi and 87 psi.
- c. Water supply is off: Turn on the feed water adapter or water supply valve.
- d. Incorrect filter installation: Reinstall the two filters, make sure they are fitted into properly.
- e. A tubing is crimped: Check all tubings and remove any crimps.

• Low Water Flow at RO Faucet

- a. A tubing is crimped or there's a leak from the tubing connection: Check to ensure all tubing is installed correctly and completely.
- b. Filter expires: Check the filter life indicators to confirm which filter needs to be replaced and replace it immediately.
- c. Low water temperature: Be sure to use the system in a temperature of 41-100 °F.
- d. Use well water as the source and the feed water has not been through a pre-filtration system, the filter has been clogged. If you are using well water as the source, please ensure that the feed water has been through a pre-filtration system. Otherwise, large particles in the well water will easily clog the filter and shorten the filter life.

• High TDS in Filtered Water

The system will provide a 90%+ TDS rejection rate (tested under standard laboratory conditions) after full flushing when working properly. If the TDS reading is high, the following are possible causes:

- a. The system hasn't been used for a long time. Turn on the RO faucet, and allow water to run for a while. The TDS reading will return to normal.
- b. The RO membrane filter expires: Replace the RO membrane filter immediately.
- c. The waste water tubing may be crimped or clogged: Check and remove crimps. Realign the drain saddle and drainpipe.
- d. The source water may have a high TDS: Test the source water and filtered water. The filtered water's TDS should be about 5%-10% of your source water's TDS. This is a normal range. If there is a high TDS in the source water, it may reduce the service life of the system. When the filtered water's TDS creeps up to 15%-20% of the source water's TDS, please perform routine filter replacement.

- **Water Leakage**

- a. Check all joints, fittings and tubing connections to locate the leakage. Make sure the filters are well installed.

- **Filtered Water from the RO Faucet Tastes Like Tap Water**

- a. Incorrect tubing installation: Make sure the waste water tubing is not connected with the RO faucet.
- b. Filter expires: Check the filter life indicators to confirm which filter needs to be replaced and replace it immediately.

- **Booster Pump Overworked Reminder**

Buzzer keeps beeping for 3 minutes and then the filter life indicators on the front panel flash red.

- a. Continuously dispensing water for more than 30 minutes: Power on the system again to recover.
- b. There is a leak at the tubing connection between the system and RO faucet: Turn off the power. Check the tubing connection, make sure the tubing is inserted into the quick-connect fitting properly and firmly, and power on the system again.

- **Booster Pump Starting and Stopping Frequently Reminder**

Buzzer beeps 5 times and then the filter life indicators on the front panel flash purple. There is an internal pressure imbalance: Disconnect the power. Turn on or turn off the RO faucet completely, remove all tubing crimps. Make sure the faucet is not blocked and power on the system again.

- **Loud Sound from the RO System**

The sound will not exceed 55 dB, which makes no difference to everyday life (55 dB is tested under standard laboratory conditions, and the feed water pressure is between 14.5 psi and 87 psi). A loud sound may be caused by the following reasons:

- a. The system is not positioned in a flat area. Make sure the system is placed smoothly without shaking.
- b. The system is placed against the cabinet. Do not place the system against the cabinet. The system may vibrate when it works.
- c. The water pressure is instable. Check and confirm the water pressure is between 14.5 psi and 87 psi. The sound will decrease when the water pressure becomes stable.

Limited Product Warranty

The warranty of our product covers defects in materials and workmanship from the original date of purchase. During the warranty period, we will replace or repair any part which is deemed to be defective, if the product has not been subjected to tampering, alteration, lack of regular maintenance or improper use after delivery. The cost of repair or replacement under those excluded circumstances shall be borne by the consumer. This limited warranty does not cover the following items: filters and all other parts or components that require regular replacement as a result of ordinary usage. This limited warranty only applies if the system is installed, used, and maintained in compliance with all instructions and requirements enclosed with the system.

This limited warranty shall only be valid if:

1. The feed water pressure is no less than 14.5 psi and no longer than 87 psi;
2. The feed water temperature must be no less than 41°F and no more than 100 °F;
3. The feed water must have a pH between 6.5 and 8.5;
4. Turbidity must be less than 1.0 NTU.

Any information or suggestion with respect to our product concerning applications, specifications or standards is provided solely for your convenience.

The quality of water supplies may vary seasonably or over a period of time. Your water usage may vary as well. The manufacturer shall assume no liability for the determination of the proper equipment necessary to meet your requirements, and we do not authorize others to assume such obligation on our behalf. You must verify and test the suitability of any information with respect to the product for your specific application.

This limited warranty shall be void if:

1. The cartridge filters are not replaced on the recommended maintenance schedule;
2. The product is purchased from someone other than our official website or our authorized dealers, as we cannot verify or guarantee the integrity or authenticity of the product.

Our sole obligation under this warranty shall be repair or replacement of a non-conforming product or parts of this product, or at our option, return of the product and a refund of the purchase price. Our obligation does not include the cost of transportation. We are not responsible for damage in transit, and claim that such damage should be presented to the carrier by the customer.

The warranties set forth herein are the only warranties made by us with respect to the product. We make no warranties, expressed or implied, including, but not limited to, any warranties of fitness or merchantability, except as expressly set forth above.

NOTE: In case some states do not allow limitations on how long an implied warranty lasts, you may choose to return the system. If you choose to keep it, you agree that the above limitations still apply to you.

Warranty Registration

Please visit our website www.waterdropfilter.com and go to the “Warranty Registration” tab to register your product for the warranty.

We offer a 30-day money back guarantee, a 1-year manufacturer warranty, and lifetime tech support for all our products. Please be sure to fill in the order information upon registration of your system. For any questions and concerns about the product, please feel free to call or email us. Your satisfaction is our top priority!

If you are happy with our products and service, please share with your friends or share on Amazon. We would greatly appreciate your voice and support. Thank you!

How to Contact Us

✉ service@waterdropfilter.com

☎ 1-888-352-3558 Mon-Fri 8:00 AM-5:00 PM (PST)

🌐 www.waterdropfilter.com (live chat available)

Manufacturer: Hongkong Ecoaqua Co., Limited

Address: Flat/Rm A 20/F, Kiu Fu Commercial Bldg 300 Lockhart Road, Wan Chai., HK



Reverse Osmosis Water Filtration System

Call us:

1-888-352-3558

Mon-Fri 8:00 AM-5:00 PM (PST)

Made in China

V001



service@waterdropfilter.com



www.waterdropfilter.com