



LIONENERGY™

SAFARI UT™ 700

12.8V / 56Ah / 716Wh
Portable Power Unit
User Manual



WARRANTY INFO:

Serial number _____

Purchase date _____

CUSTOMER SERVICE:



385.375.8191. Monday-Friday / 9:00 AM - 5:00 PM. MST.
Please call our customer service department before returning
your Safari UT™ 700.

WELCOME TO THE PRIDE.

The Lion Energy™ journey began in 2001. We started this venture to help people prepare for potential emergencies and become self-reliant. We realized we could help in areas of food, water, lights, and *power*. And our passion for portable power ignited. We wanted to provide the safest, most reliable, silent portable power products and we wanted them to be clean and renewable. Our goal is to create products that are good for people and good for our planet! At Lion Energy, that's exactly what we do.

Lion Energy is built upon the principles of unmatched safety, unwavering reliability, and continual renewability advancements. That foundation, coupled with a promise of excellent customer service, has led to a growing brand with an extremely loyal customer base.

As we forge ahead, the foundations of customer experience, safety, reliability, and innovative renewability remain. We are committed to a continued focus on providing the best emergency preparedness power, portable solar power, and home storage power. Lion Energy is committed to providing our customers peace of mind and the freedom to live life on their terms.

For latest info go to www.lionenergy.com



735 S. Auto Mall Drive Suite 200
American Fork, UT 84003



www.lionenergy.com
info@lionenergy.com



corporate: 801.727.9270
tech support: 385.375.8191

Lion Energy
Safari UT™ 700 Power Unit
Manual



Thank you for choosing the Lion Energy Safari UT™ 700

Welcome to Lion Energy Products

At Lion Energy we provide portable power that is safe, silent and renewable. Our products are used in emergencies and for work and play. Please read the user manual carefully before using the product and always take care when using this product. This product is not intended for use by young or infirm persons without supervision.

Attentions and Warnings:

1. Do not disassemble, resemble, or repair the battery. Incorrect reassembly may cause combustion or electric shock.
2. If the battery is damaged, contact the place you purchased it.
3. Do not short-circuit the battery, use it near heat or water sources, or allow it to become wet.
4. Do not insert nails or other objects into the battery, strike it, or weld directly on the battery.
5. Do not use a badly damaged battery or operate it with damaged cables or charging adapters.
6. Do not operate this product in explosive atmospheres (i.e. flammable liquids, gases, or dust) or set the unit on flammable materials (i.e. carpeting, upholstery, paper, cardboard).
7. Do not permit the battery to freeze. Never charge a frozen battery.
8. In case of skin or eye contact, rinse immediately with clean water and seek medical attention.
9. Do not keep using this product if it is damaged, waterlogged, distorted, or broke.
10. This product contains lithium ion batteries. When it is worn out dispose it properly using local laws and regulations.

Battery Pack Electrical Specification

#	Item	Parameter
1	Nominal Voltage (Works with 12V Systems)	12.8V (12V)
2	Technical Rated Capacity Commonly Referred To As	54Ah (56Ah)
3	Minimum Capacity	≥53Ah
4	Internal Resistance	≤1.2mΩ
5	Standard Charging Current	20A
6	Max Charging Current	56A
7	Max Charging Volt	15.4V
8	Max Continuous Discharge Current	100A
9	Discharge Over Current Protection	105A 1 Minute
10	Discharge Protection Voltage of Single Cell	2.5A
11	Operating Temperature	Charge: 32~113°F 45 ~ 85% RH Discharge: -4 ~ 130°F 45 ~ 85% RH
12	Storage Temperature	-4 ~ 113°F 45 ~ 85% RH 14 ~ 95°F 45 ~ 85% RH
13	Product Size	10.0" L x 6.0" W x 8.6" H
14	Product Weight	16.5 pounds

Charging Recommendations and Limitations

The below diagram is a reference on how to connect four batteries in parallel 12V system. *Before connecting, each battery must be independently fully charged.* This battery should never be installed in series with another battery.

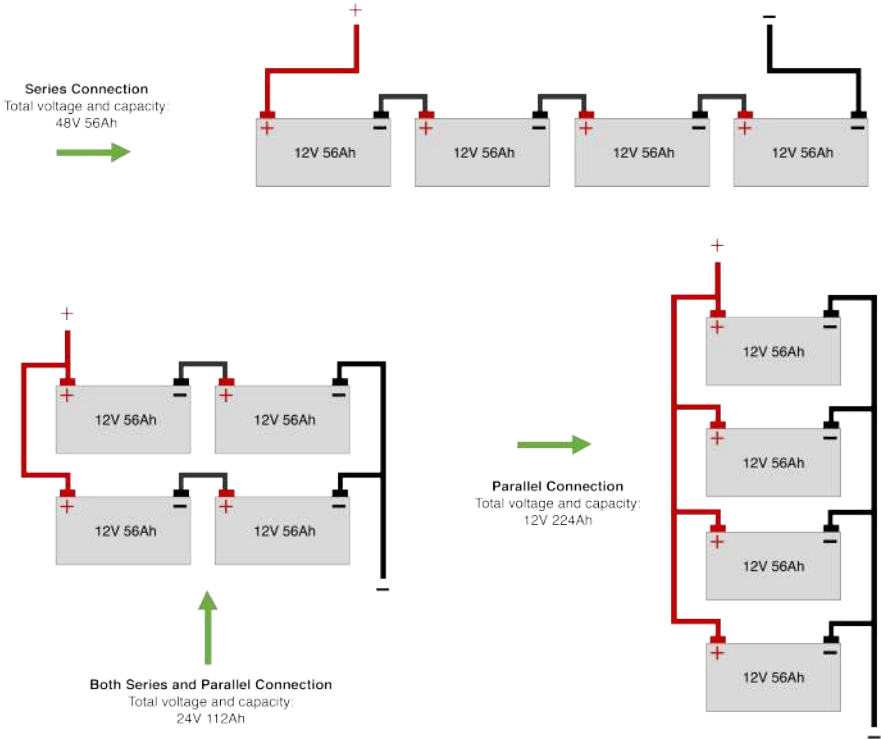

- The battery must be charged within a specified charging rate and the ceiling voltage of charging should be within the specification limits to avoid over charging. Over charging will lead to poor performance, mechanical instability, and possible safety issues.
- The battery should be used within specified discharge rate and the lowest voltage should be within the specification requirements to avoid over discharging. Over discharging will lead to poor performance, over heat, lead to battery failure, and possible safety issue.
- The battery must be used under required ambient environment according to specification. Too high or too low temperature may affect the performance of the battery.
- Constant charge/discharge rate not to exceed 0.5C to maximize the life span of the cell.
- Use the battery within 80% DOD to extend the service life of the cells.
- Battery must be fully charged and disconnected from all loads before storing for any amount of time.

Maintenance Suggestions

- For storage over one month, place the battery in a dry and ventilated room that is within the recommended storage temperatures.
- Do not store near corrosive material, fire, and heat sources.
- Discharge and charge the battery until full once every six months if not being used.

- In order to avoid over discharge, charge the battery periodically at the suggested battery storage voltage (13.3V, 80% SOC or greater) to avoid over discharge.

WARRANTY REPAIRS/REPLACEMENTS

For repair or replacement, contact customer service at 1-385-375-8191. Do not ship unit until you receive a Return Merchandise Authorization (RMA) number from customer service at Lion Energy. Lion Energy will not be responsible for any shipping or handling damage.

LIMITED WARRANTY

This warranty for the unit is extended to the original purchaser or user, and it covers defects in materials and workmanship. The Safari UT700 has a limited 10 year warranty and will maintain a charge for up to 3,500 life cycles.

This warranty is invalidated if any of the following occurs, but not limited to:

- Failure to follow the instructions in the User's Manual.
- Accidental or unreasonable use, misuse, over charging or loading, or normal wear.
- Extended storage without recharging or repairs done by an unauthorized person or modification.
- Opening or modifying the battery casing.

This warranty is in lieu of all other express warranties. Lion Energy will not be liable for consequential or incidental damages. Changes or modifications not expressly approved by Lion Energy could void the user's authority to operate this device.

SERVICE ADDRESS

Lion Energy (www.lionenergy.com)

Email: Info@lionenergy.com and Tel: 1-385-375-8191

Address: 735 S. Auto Mall Drive, Suite 200, American Fork, UTAH 84003

LION SAFARI UT™ 700

IT CAN POWER...



*Run Times Vary

MORE POWER TO LOVE...



LION 100™

Harness the power of the sun and recharge or power your electronic devices. This 100W Foldable Solar Panel comes with a 6' extension cord and a 20-year life expectancy.



SAFARI LT™

This great and little power unit packs a punch and weighs only 11 pounds. Take it camping, tailgating, to the beach or anywhere you need power.



CUB MS™

The Cub MS will do a lot more than jump start your vehicle, RV, and large boat engine, it will also charge phones, tablets, ham radios or anything that can charge from a USB cable. Recharge the Cub MS from the wall or the 12-volt plug in your car.

Check out www.lionenergy.com to get these and other great products from Lion Energy!



Lion Energy, LLC

735 S. Auto Mall Drive Suite 200
American Fork, Utah 84003

info@lionenergy.com

385.375.8191
Monday-Friday
9:00 AM - 5:00 PM MST

www.lionenergy.com