

Burner Collection

72" Burner

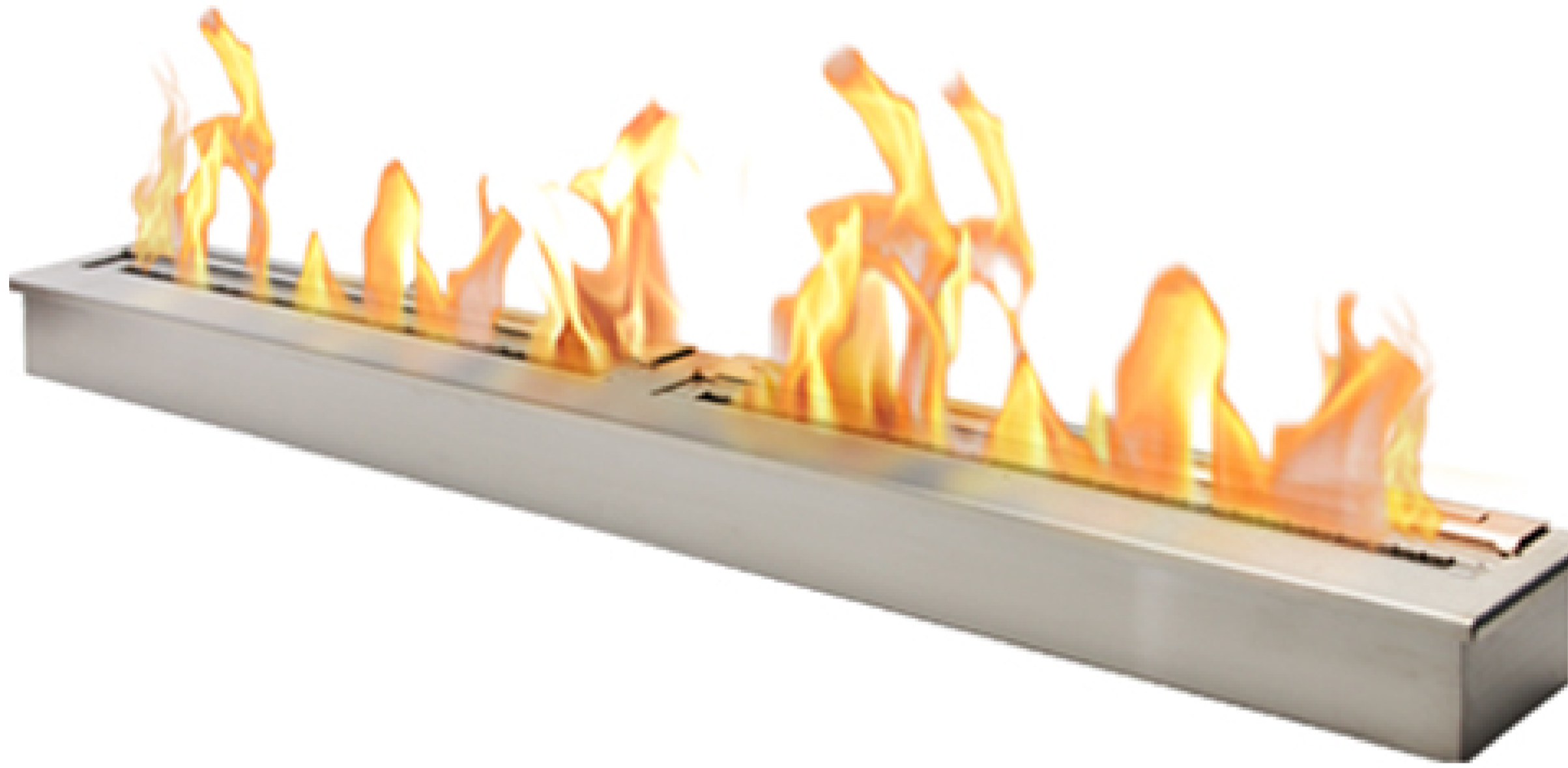

Black



Included Accessories



Lighting Rod



Lighter



Funnel

Burner Collection 72" Burner

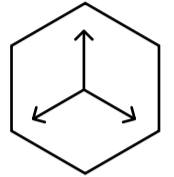
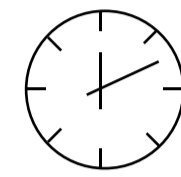
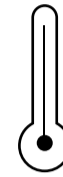
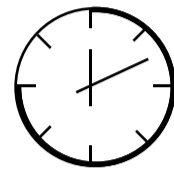
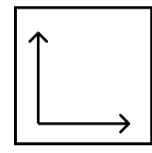
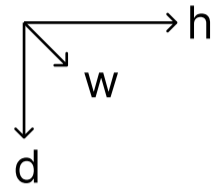

| Dimensions H x W x D mm/in | Fuel Capacity | Heats on Average (indoors) | Fuel Consumption | Thermal Output Net (MAX) | Approx. Burn Time | Minimum Room Size (per burner) |
|--------------------------------------|------------------|--|---------------------|-----------------------------|----------------------|-----------------------------------|
| 115 x 1829 x 193 4.5 x 72.0 x 7.6 | 21.5L | Over 169m ² [1,819 ft ²] | 2.15L per hour | 47,400BTU/h 13.9 Kw | 10 hours | 400 sq. ft. |

Awards

2010 Winner Outdoor Hearth Products
Vesta Awards

Application

Indoor & Outdoor

Burner Colour

● Stainless Steel ● Black

Materials

Grade 304 Stainless Steel Construction

Approx. Weight

66 lbs

Fuel Type

Bio Ethanol Fuel

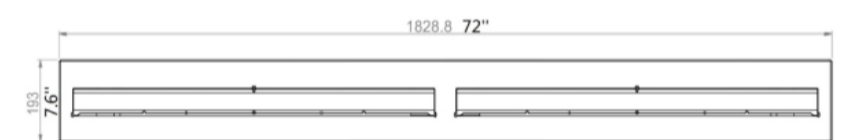
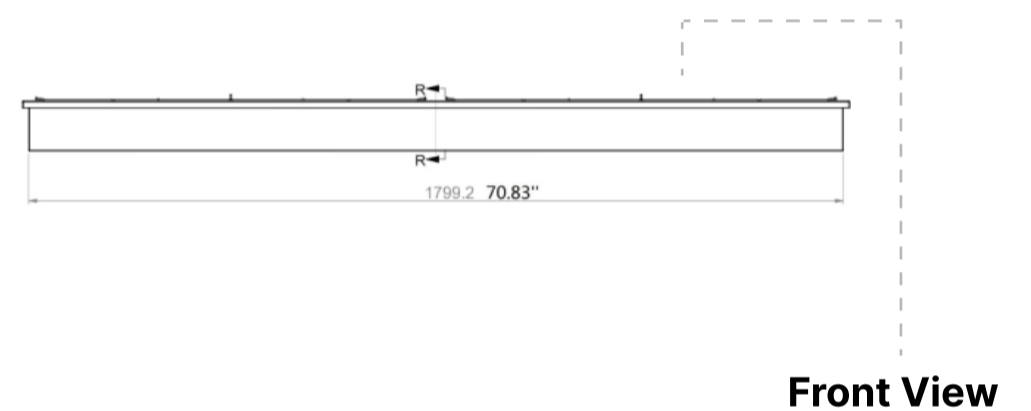

Top View

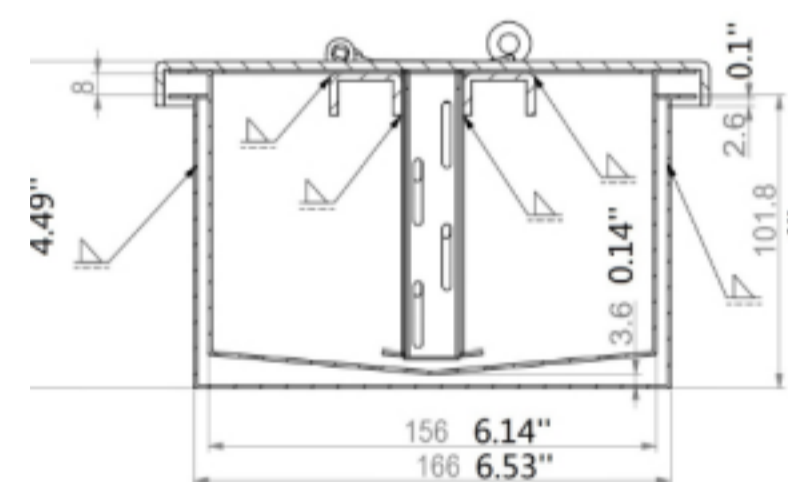

Side View

Inserting within a firebox setting:

The Bio Flame 72" BURNER can only be fitted into a non-combustible firebox that has minimum clearances of 80"W x 20"H x 15"D.

Custom made fireboxes must:

- Be made out of a non-combustible material such as stainless steel
- *When recessing the tray into a non-combustible base with no firebox, the overhead clearance required is 60"MIN. to the nearest combustible*



Global Compliance
All burners are UL Listed in accordance with ANSI/
UL1370 in the USA and comply with the ACCC Safety
Mandate for Australia.



Lifetime Warranty

FOR MORE INFORMATION PLEASE REFERENCE THE CLEARANCE & INSTALLATION MANUAL

*Dimensions may vary by 2% (plus or minus) due to material attributes. Template not provided. The Bio Flame recommends using the actual fireplace or burner model when making final cut out

