



Stool |chamfer|

Stool

The stool |chamfer| offers limitless applications with its gentle yet confident appearance. It is suitable for a variety of public and private spaces, whether inside or outside. It can be used as a tool and simultaneously be a seat, shelf, side table, or stepladder. A versatile piece of furniture that meets the need for functionality and aesthetics.

Dimensions: 28 x 28 x 45 cm (length x width x height)

Material: Neolign® (> 83% wood chips) | 3 mm sheet steel (powder-coated)

Neolign®

Neolign® is a circular, natural, innovative and industrial wood-based material. It has a natural fiber content of over 83% as a by-product from industrial wood processing and recyclable plastic. Cradle to Cradle describes a concept that brings ecology and economy into a synergetic harmony. This unique circular system guarantees 100% loss-free recycling. The result is a harmoniously changing cycle – just like in nature.

Packaging

Creating a sustainable product means thinking through the entire process holistically. When packing, we make sure that we do not use plastic and rely on recycled materials. Tools and screws are packed in recycled kraft paper bags and sealed with stickers. Our stickers and greeting cards are made from grass paper and this assembly instruction is printed on recycled paper.

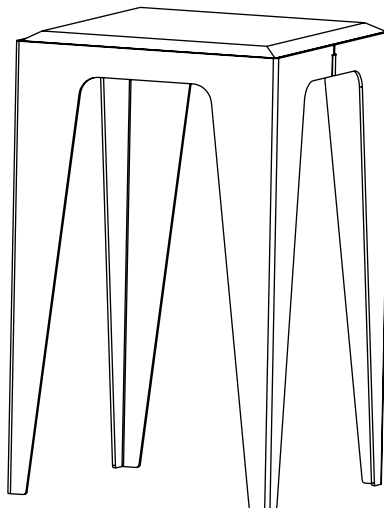

CONTENT

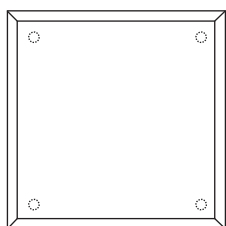

1 x Neolign® board



2 x screw

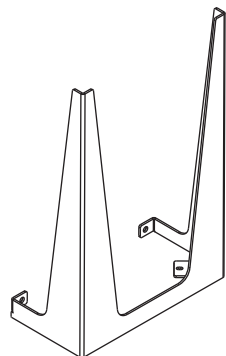

2 x metal piece



4 x scratch protection



2 x flat washer (if needed)



2 x nut



4 x wing screw

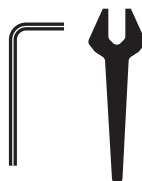

1 x set of tools

ASSEMBLY

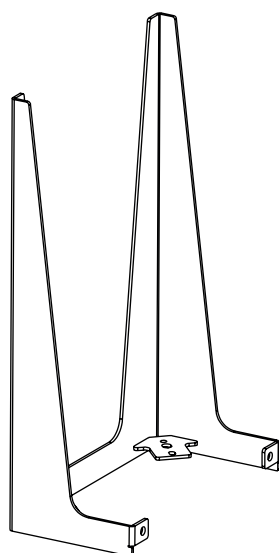

1

Place the Neolign® board on a flat surface with the screw holes facing up.

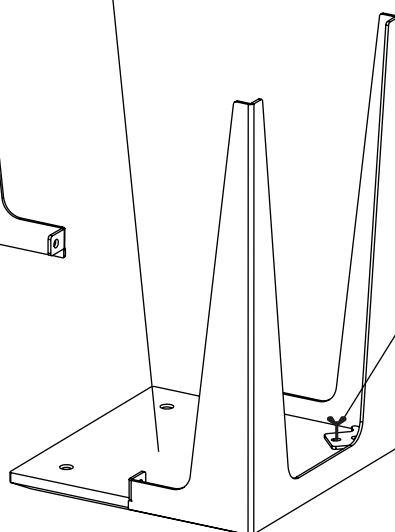

2



Place the individual rack parts on the board and align them by screwing them on with wing screws. Tighten them slightly for now so you can readjust later.



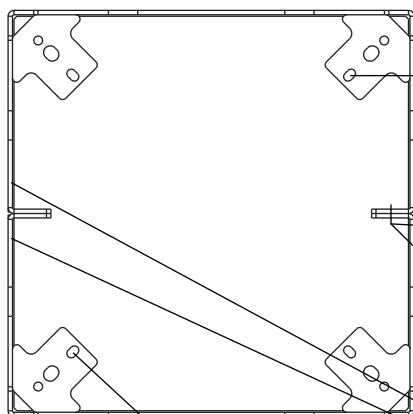

3



Attach one wing screw on each corner.

4



Connect the individual rack parts by using the screws and nuts.

5



Use the tool provided to tighten the nuts and bolts completely with gentle force.

NOTICE

For a clean profile, the table legs must be flush with the struts.

6

After everything is aligned, fully tighten all screws with gentle force.

7

Place the furniture on its legs carefully. Avoid putting weight on only two legs.

WYE HACKS

The series |chamfer| is a static miracle. The design enables the furniture to adapt to the surfaces and loads like a skeleton. Each strut and screw serves its purpose to create a delicate yet highly resilient piece of furniture. If your furniture should wiggle due to unforeseen tolerances, you can balance the construction with the washers.

1 Firm stand

Counteract possible wiggling and ensure a firm stand by gently pulling all four steel feet outwards with a slight jerk.

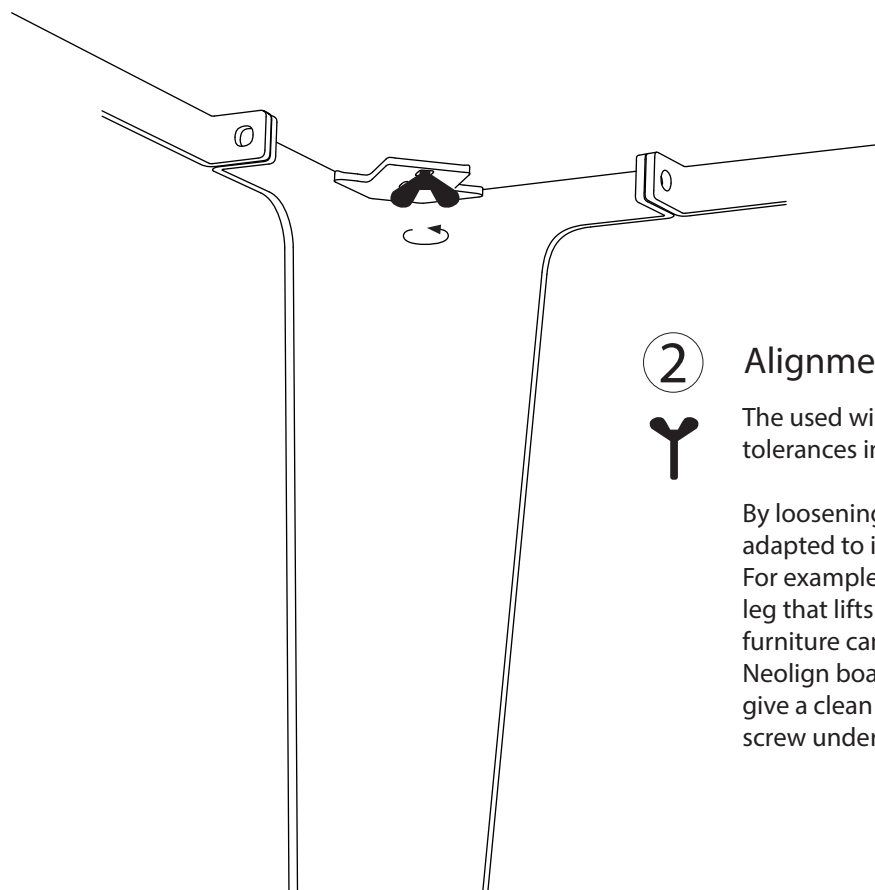
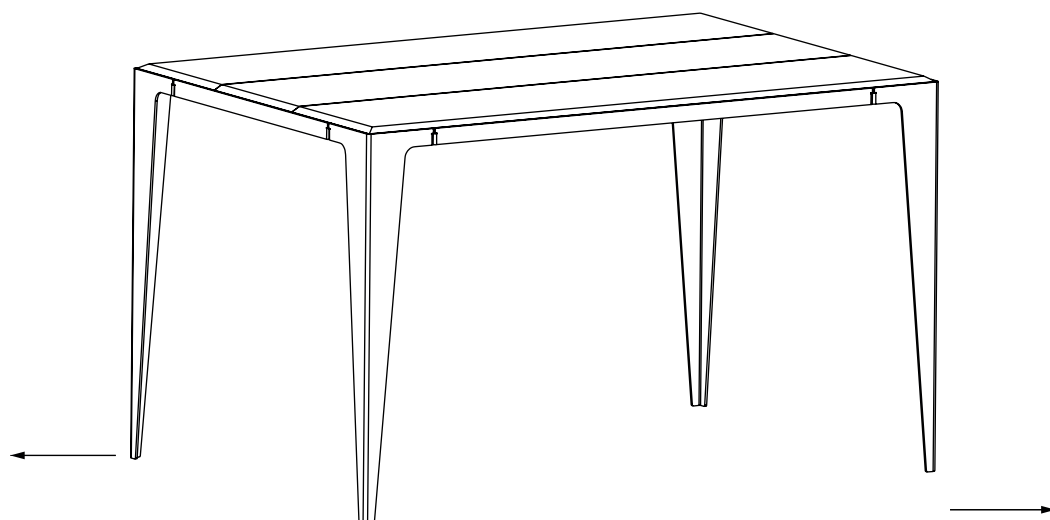

2 Alignment



The used wing screws allow you to counteract tolerances in many ways.

By loosening them slightly, the furniture can be adapted to individual circumstances. For example, if you loosen the wing screw on the leg that lifts off the floor, a slight wiggling of the furniture can be avoided. This also helps if the Neolign boards lying next to each other do not give a clean profile. To do this, loosen the wing screw underneath the board that is a little lower.

3 Uneven surfaces



With the help of the enclosed washers, it is possible to compensate stronger tolerances in wiggling. Proceed as follows:

1. Set up the furniture and determine the feet that are not touching the floor. Usually, these are the two diagonally corners.
2. Turn the furniture upside down and loosen the wing screws on those feet. Ask a second person for help to flip the furniture around if needed. Gently lift the leg and place the washer between the Neolign® board and the leg.
3. Tighten the wing screw with gentle force as usual.
4. Flip the furniture back on its feet. Ensure a firm footing by gently pulling all four steel feet outwards with a slight jerk.

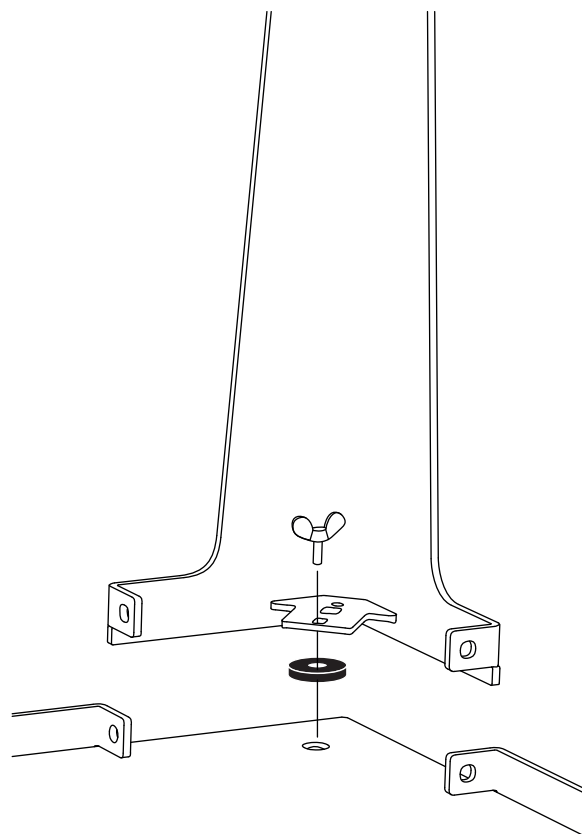

4 Scratch protection



The WYE scratch protection for our furniture consists of 100% fine Merino sheep's wool from Germany and is processed in Austria for us. The merino wool is characterized by its excellent quality and biodegradable.

The scratch protection not only protects sensitive surfaces, but also prevents the furniture from wiggling on uneven surfaces, like flagged floors in outdoor areas.

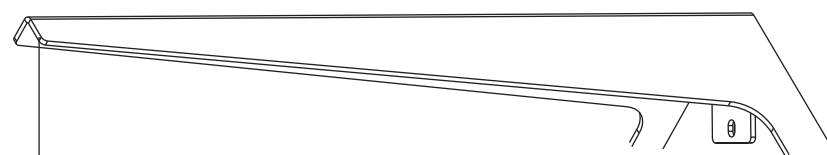

Remove the protective adhesive film from the scratch protection and stick it to the underside of the furniture base with the adhesive side facing up. Place the scratch protection in the middle so that the felt protrudes on both sides.

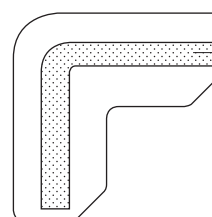

furniture foot

scratch protection

NOTICE

We recommend Neolign® Care for the stain-free use of our furniture. It works well with Neolign® and all types of wood indoors and outdoors. It is an environmentally friendly, weather-resistant, and highly water-repellent coating based on natural oils.