



POWERCAP[®] INFINITY[®] POWERED RESPIRATOR SYSTEM USER INSTRUCTIONS



AS/NZS1716:2012 Respiratory protection

AS/NZS1337.1 Eye & Face Protection

AS/NZS1801 Head Protection

IMPORTANT: This manual must be read in full, the user should be familiar with and trained in the use of the product before the product is used. This manual must be retained for future reference.

CONTENTS

AS/NZ

Applications	4
Unpacking & Inspection	4
Storage	5
Before Use	5
Charging the Battery	5
Battery & Airflow Check	6
General Use & Warning System	7
Using PowerCap® Infinity®	7
Donning	8
Warning Scenario Table	9
Doffing	9
Maintenance	9
Filters	9
Removing & Replacing Filters	10
Removing & Replacing Pre-Filters	10
Removing & Replacing the Visor	11
Removing & Replacing the Face Seal Skirt	12
Removing & Replacing the Drive Unit & Visor Carrier Assembly	13
Removing & Replacing the Visor Cover	13
Removing & Replacing the Harness Strap	14
Safety Precautions	15
Additional Industrial Safety Helmet Instructions	15
Additional Industrial Eye Protection Instructions	16
Markings	16
Warranty	17
Battery Information	17
Cleaning	18
Accessories	18
Replacement Parts	19



If further assistance is required, please scan the QR codes in this manual to view a playlist of instructional videos or visit bit.ly/Infinity-Videos

This manual must be retained for future reference.

APPLICATIONS:

PowerCap® Infinity® is intended for use in areas where respiratory protection from dust, spores, mist and fumes, head protection from falling objects and eye/face protection from high-speed particles is required.

PowerCap® Infinity® provides respiratory protection to the requirements of AS/NZS1716:2012 PAPR-P2 device. PowerCap® Infinity® has a Work Exposure Standard (WES) up to 50x.

PowerCap® Infinity® provides head protection to the requirements of EN397, ANSI Z89.1, CSA Z94.1 and GB2811, AS/NZS1801. The head protection offers protection from falling objects. As part of the PowerCap® Infinity®, some aspects of the performance of the helmet are affected. It should not be used in sub 5°C temperatures.

PowerCap® Infinity® provides eye protection to the requirements of AS/NZS1337.1 at high impact resistance, 'V'. The PowerCap® Infinity® has a face seal skirt to provide both respiratory protection and a good field of use protection against dust particles. PowerCap® Infinity® is a loose fitting item of respiratory protection. It may offer respiratory protection to the wearers of prescription eye wear.

PowerCap® Infinity® also has the facility to be able to accept the JSP Sonis® helmet mounted hearing protection to provide protection against the harmful effects of noise.

UNPACKING & INSPECTION:

The carry-case contains:

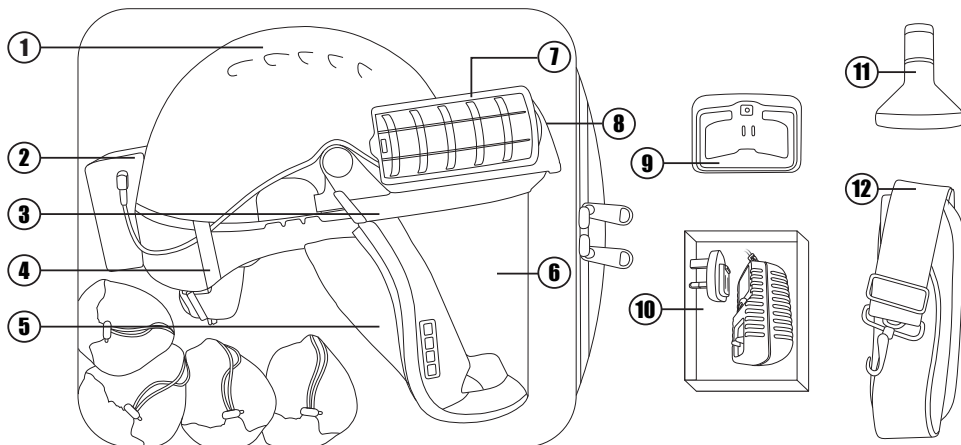

NO.	ITEM
1	EVO5® Safety Helmet
2	Battery Pack
3	Visor Carrier
4	Cable Clip
5	Face Seal Skirt
6	Visor
7	Filters

NO.	ITEM
8	Drive Unit
9	Charging Dock
10	6v 2.5A Power Supply
11	Flow Test Unit
12	Strap for Carry-Case
13	User Instructions (Not shown)
14	Hygiene Bag for Soiled Items (Not shown)

STORAGE:

- Store in the carry case provided.
- Store away from direct sunlight.
- Avoid contact with solvents and solvent atmospheres.
- Avoid physical contact with abrasive or hard surfaces.
- Store at temperatures between +5°C and +40°C.
- Store at relative humidity not greater than 75%.
- Disconnect the cable from the battery pack during storage.
- Do not stack objects on top of carry-case.

BEFORE USE:

- Fully charge batteries for 8 hours before first use. (See *Charging the Battery*).
- Check charge level by pressing the power button momentarily. (See *Battery and Airflow Check*).
- Read the adjacent LED charge level indicator. (See *Battery and Airflow Check*).

CHARGING THE BATTERY:



- 1. Remove the battery pack.** Unplug the power cable from the socket, release the clasp at the base of the battery pack and pull the bottom of the battery pack away from the helmet.
- 2. Attach the correct plug adaptor for your region to the 6v 2.5A power supply.** Only ever use the power supply provided with this unit.
- 3. Plug the power supply cable into the rear of the PowerCap® Infinity® charging dock.** Plug the power supply into the mains socket and switch on. (The dock LED will glow green).
- 4. Charge the battery pack.** Insert the battery pack into the charging dock until it clicks (the dock LED turns from green to red.) The battery is now charging. Once charging is complete, the dock LED will glow green.
- 5. To remove,** hold the dock down and pull the battery upwards.
- 6. Replace the battery pack.** Hook the top of the battery pack into the top of the helmet clip, rotate the battery pack fully into the helmet clip and lock in place with the bottom clasp. Plug the power cable into the socket. The battery has an expected life of 500 cycles when charged in accordance with these instructions.

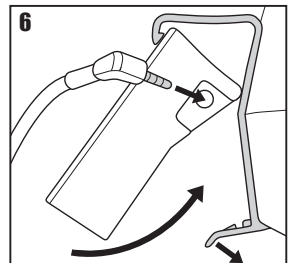
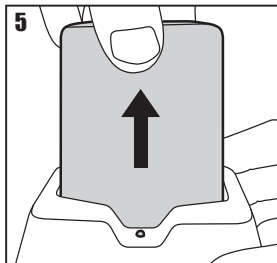
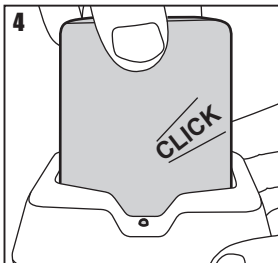
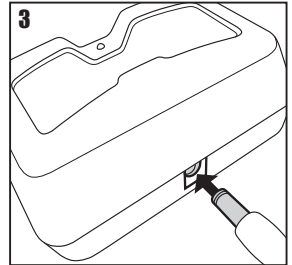
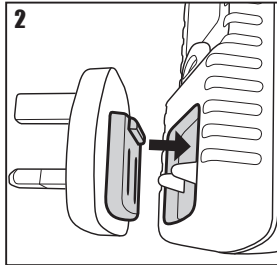
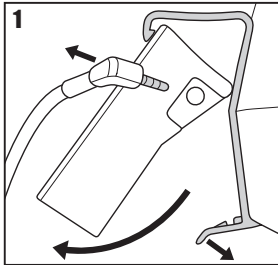



- 1. Checking the battery.** Insert the male power cable connector into the battery pack. Check the charge level by momentarily pushing the switch on the battery pack. The 5 LEDs represent 100-80%, 80-60%, 60-40%, 40-20%, 20-0%.
- 2. Switching on.** Hold the unit in the upright position, turn the unit on by pushing and holding the switch on the battery pack. The adjacent LED charge level indicators will light momentarily. Airflow will commence. The drive unit warning buzzer will sound momentarily, release switch after the unit buzzer is heard. The Heads-Ups Display (HUD) in the visor will flash through its start-up sequence. During use, a single red indicator will be illuminated.
- 3. Checking the airflow.** (Always check the airflow level before use using the airflow indicator provided). Invert the PowerCap® Infinity® so it is resting on the helmet and the two filters. Open the peak of the helmet slightly from the drive unit, locate the airflow indicator, close the peak to secure airflow indicator.
- 4. Avoid placing hands or other possible obstructions over the filter inlets.** The ball indicator within the airflow device should move fully into the "green zone" this will indicate adequate airflow for PowerCap® Infinity® to be used. The ball indicator in the green zone will be accompanied by a green HUD light. Insufficient flow will be indicated by the ball being all or partly in the "red zone". If the flow test unit and/or HUD lights indicate insufficient flow: Check the battery fitting and connection and check the charge condition. Check the filter and pre-filter condition (See Removing & Replacing Filters and Removing & Replacing Pre-Filters sections). In the event that there is still insufficient airflow, do not use the product, but contact JSP Ltd for further advice. The HUD/Audio alert lights should always be the primary method of assessing flow levels.

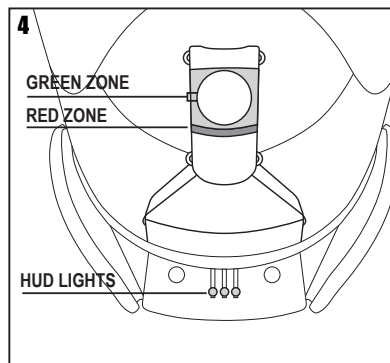
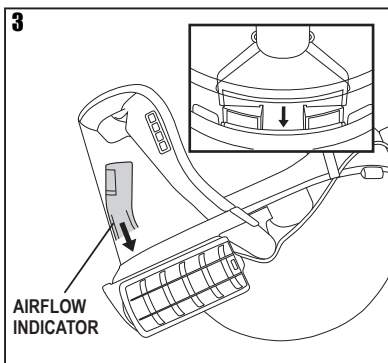
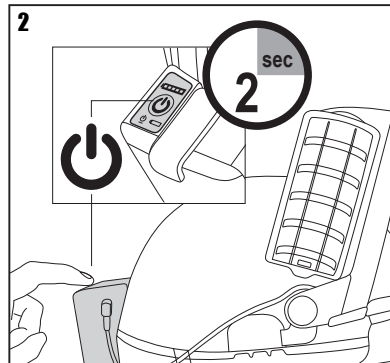
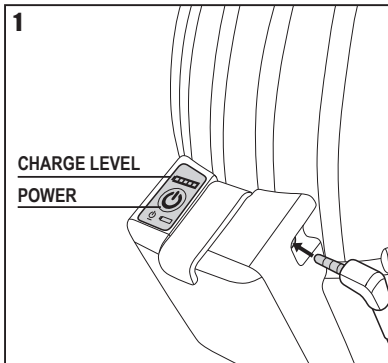

GENERAL USE & WARNING SYSTEM:

- PowerCap® Infinity® will deliver a minimum 160L/min of filtered air to the user for upwards of 8 hours through a fresh pair of filters.
- The user may notice changes in motor tone associated with movement, this is a normal operational sound linked to motor construction.
- The array of LEDs at the top of the field of vision is a Head-Up Display (HUD) informing the user of PowerCap® Infinity®'s status. See warning scenario table.
- As the battery approaches low remaining charge, the green light will be joined by a flashing red light to inform the user of having approximately 20 minutes to withdraw from the hazard area to replace/recharge the battery.
- As the battery approaches a fully discharged state, the green light will extinguish and the flashing red light will be joined by a two-tone buzzer. The user should withdraw from the hazard zone immediately to replace/recharge the battery pack.
- Do not use or store PowerCap® Infinity® at temperatures below +5°C as the battery performance can be affected.
- When the green light is replaced by a blue flashing light and a pulsed buzzer tone, the system is no longer able to deliver sufficient airflow as the filters have become blocked. The user should withdraw from the hazard zone immediately to check and/or replace both filters.
- PowerCap® Infinity® is rated as IP54 for protection against water and dust ingress. The unit can be used in dusty environments and inclement weather conditions. It should not be immersed in water.

USING POWERCAP® INFINITY®:

- Operating temperature should be between +5°C and +40°C and relative humidity not greater than 75%.
- PowerCap® Infinity® offers respiratory protection against spores, fibres, fumes (very fine metallic droplets/particles) and dusts.
- The visor offers protection against high impact resistance to AS/NZS1337.1.
- The EVO5® helmet offers protection against falling objects to AS/NZS1801.



1. Turn PowerCap® Infinity® on by pushing and holding the switch on the battery box. Wait for the drive unit buzzer to signal that it has started. Sufficient airflow must be checked as described in the *Battery and Airflow Check* section.
2. Place the helmet on the head with the visor in the raised position, pressing the head firmly into the padding at the front of the helmet. Tighten the helmet strap by turning the wheel ratchet at the rear of the helmet clock-wise. Adjust for a comfortable, secure fit. It may be necessary to adjust the position of the head strap in the helmet using JSP's 3D adjustment system to achieve a comfortable, secure fit. An instructional video on how to use this system can be found on JSP's YouTube channel [bit.ly/Infinity-Videos](https://www.youtube.com/channel/UC1tYlYnYnYnYnYnYnYnYnYn).
3. Locate the two tabs on the seal skirt with the index fingers uppermost and thumbs underneath.
4. Pull the face seal skirt and visor assembly down by tabs so the seal skirt is fully underneath the jaw.
5. Peel the excess sides of the skirt outwards with the index fingers to fully seal around the face. Ensure that the seal skirt tabs are outside the skirt.
6. Check for the green indicator on the Head-Up Display (HUD). When correctly donned, no part of the face seal skirt should be in front of the face. Check by looking in a mirror or seek assistance.

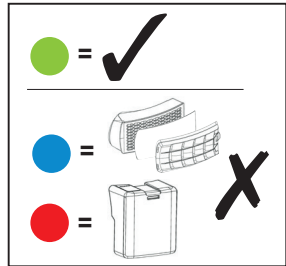
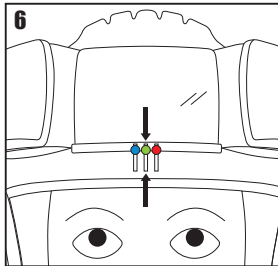
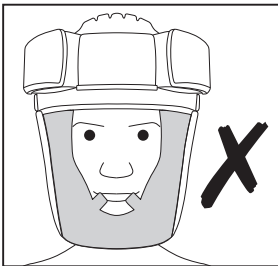
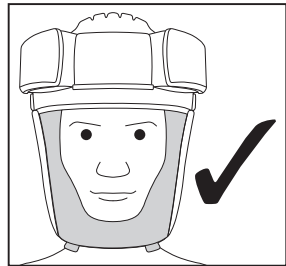
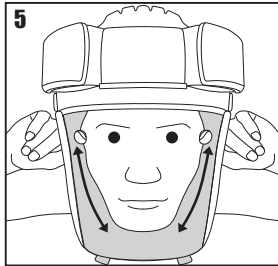
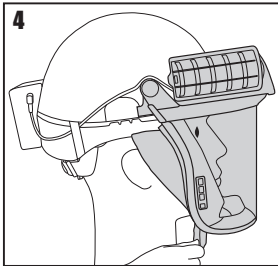
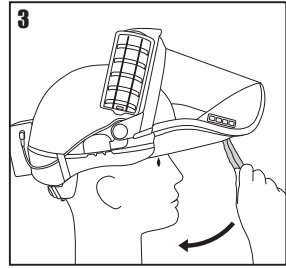
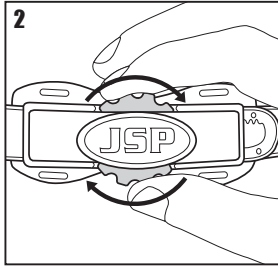
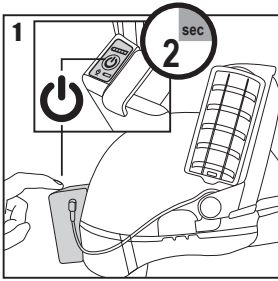

WARNING SCENARIO TABLE:

SCENARIO	DISPLAY	BUZZER	COMMENTS
Start up	Red, green, blue	On (2s)	System OK
Standard running	Green static	Off	System OK
Low battery level	Green (Red flash every 2s)	Off	20 minutes remaining
Discharged battery	Red flash	High-low tone	Recharge battery
Blocked filters	Blue flash	High pulsed	Change BOTH filters
Other fault	Red, blue (repeat)	High pulsed	Contact JSP Ltd

DOFFING: (DO NOT remove the product whilst in the hazard zone)



1. Pull the tabs on the seal-skirt outwards and upwards to raise the visor.
2. Turn the red adjustment wheel anti-clockwise to loosen the helmet. Lift the assembly off the head.
3. Press and hold the power button on the battery pack to switch off. The adjacent battery charge level indicator will light momentarily to display the remaining charge level.

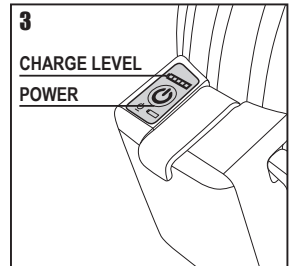
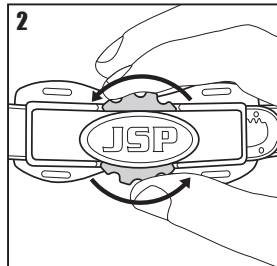
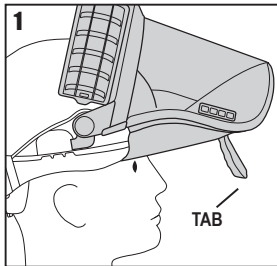

MAINTENANCE:



It is important to follow these instructions to ensure that the PowerCap® Infinity® gives optimal performance. Regular maintenance is important. If the maintenance and usage instructions in this leaflet are not followed, the effectiveness and the protection offered by the PowerCap® Infinity® may be severely reduced. A Radio Frequency Identification Device (RFID) has been built in to the product to allow maintenance records to be kept, reviewed and amended by your own product support representatives using JSP's Asset Management system. This allows you to have full control over your PowerCap® Infinity® giving full access in the field to inspection dates, compliance documentation, product instructions and much more. Visit www.jspcheck.com to enable your RFID device. To view a playlist of instructional videos visit bit.ly/Infinity-Videos.

FILTERS:

- The filters provided are high efficiency particulate types supplied in pairs.
- Will filter spores, fibres, fumes (very fine metallic droplets/particles) and dusts.
- Will not filter gases or vapours.
- PowerCap® Infinity® filters are marked as per image.

Only use genuine PowerCap® Infinity® filters supplied in pairs from JSP Ltd or its distributors. Always replace both filters simultaneously. NEVER use compressed air to clean the filters. This will seriously limit protection.

 BSI BMP No. 689733	AS/NZS1716:2012 PAPR-P2
	DATE OF ISSUE: <input type="text"/>
	USE BY: <input type="text"/>

REMOVING & REPLACING FILTERS:



To Remove the Filters: Rotate the rear of each filter upwards by 30° until compression is lost, then pull away from the motor housing.

To Replace the Filters: Ensure that the filter and motor housing mating faces are clean; do not allow any dust or foreign objects to fall into the motor housing. Align arrows on filter and motor housing, press filter into place and rotate until a click is heard/felt. Recheck airflow before use. (See *Battery and Airflow Check*). **If the filters are not fitted correctly, filtering efficiency will be severely reduced.** Each filter is fitted with a pre-filter housed within a protective cover. Pre-filters prolong the life of the main filters by trapping larger particles. The pre-filters can be replaced from within the protective covers as required. Dispose of used filters in accordance with local legislation.

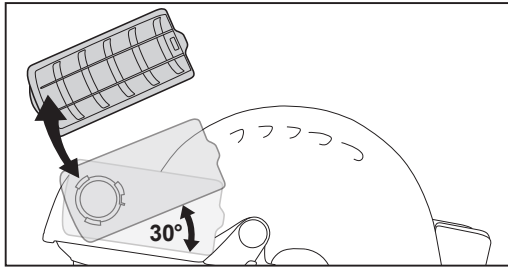

REMOVING & REPLACING PRE-FILTERS: (Always replace both pre-filters simultaneously)



1. Locate the tab at the rear of the pre-filter cover and lift it to begin freeing the cover.
2. Release the two remaining hooks from under the front of the main filter case lid to release the cover from the main filter body.
3. Pull the pre-filter out from under the three locating hooks. Dispose of used pre-filters in accordance with local legislation.
4. Clean the pre-filter cover using a damp cloth and/or soft brush, then feed a fresh pre-filter underneath the three locating hooks. Ensure the correct orientation of the pre-filter pad in the cover.
5. Clip the pre-filter cover back onto the filter, locating the curved front edge first.
6. Snap the rear clip into place over the rear of the filter case lid.

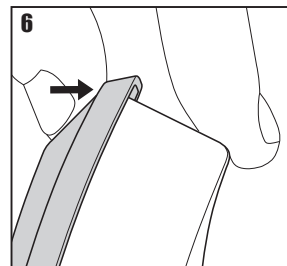
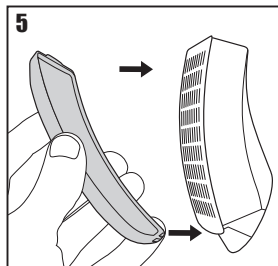
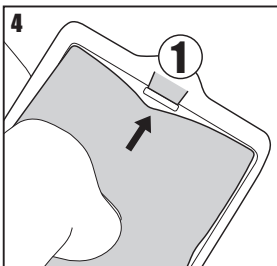
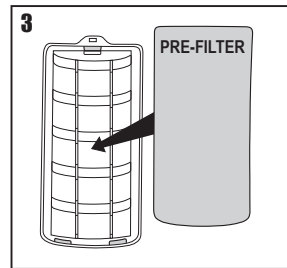
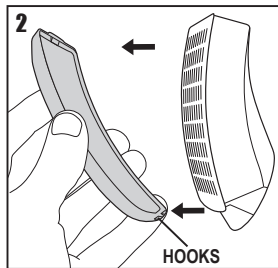
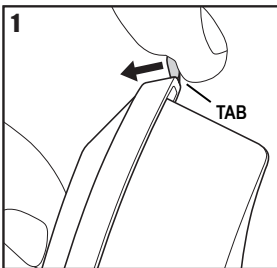

REMOVING & REPLACING THE VISOR:
(Care should be taken to avoid scratching the visor surfaces during fitting)



1. **Remove the visor.** Release by unhooking the face seal skirt tabs from the front (left/right) of visor
2. Gently pull one of the face seal skirt tabs to expose the remaining material fitted to the channel of the visor and remove
3. Orientate the helmet upside down and place in your lap with the visor facing towards your knees. Looking inside the helmet you will identify 2 x clips. Place one hand on top the visor with a firm grip, the other hand should be used to release each clip one at a time, at the same time the hand gripping the visor should be pulled towards the chest. Pulling the visor free from its location within the carrier housing.
4. **Release the visor** from its secured position pulling the visor toward your chest.
5. **Replacing the Visor** Hook each end of the visor individually, one at a time, into the visor carrier channel corners. Your thumb should be used to support the black rubber bump stop when locating the visors hooks deep within the carrier channel.
6. Place one hand on the drive unit and the other on the top of the visor. Slowly push the visor into the remaining carrier channel until the clips lock the visor.
7. Orientate the face seal skirt so that the skirt tabs face directly towards the visor align the skirt blade to the visor channel and continue to push and feed the blade until all the blade is secured.
8. Refit the Face Seal Skirt tabs to the visor (left & right).

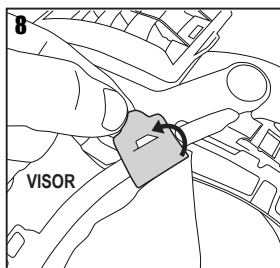
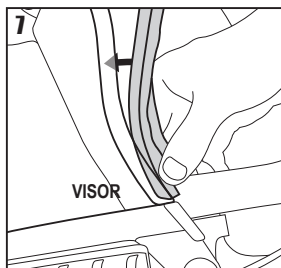
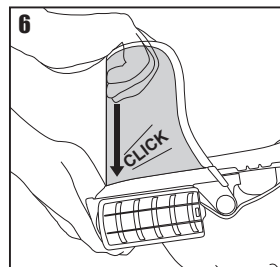
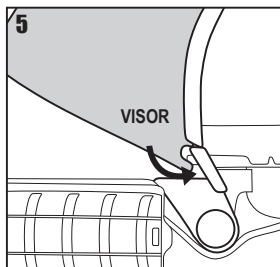
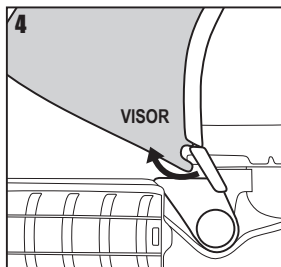
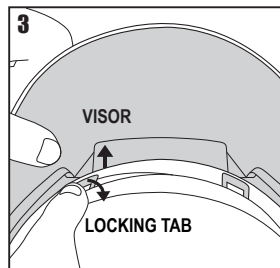
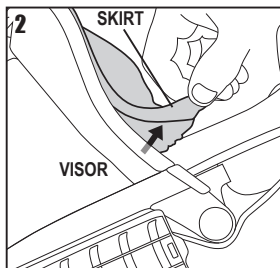
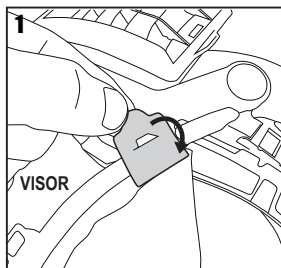



1. **Remove the face seal skirt.** Unhook the two inner and two outer skirt loops from the harness mounting points inside the helmet.
2. Unhook the plastic tab from the hook on the visor.
3. Pull the seal skirt out of its locating channel. Start the removal from either end. **DO NOT PULL FROM THE MIDDLE.** Dispose of used seal skirt in accordance with local legislation or follow cleaning instructions to reuse.
4. **Replace the face seal skirt.** Place one end of the face seal skirt sealing strip into one end of the locating channel on the visor with the rubber blade outwards. Progressively push the sealing strip into the channel to ensure a secure fit.
5. Hook the plastic tab over the hook on the visor.
6. Locate both the outer and inner set of skirt loops at one end of the sealing skirt.
7. Feed the outer set of skirt loops behind the harness inside the helmet. Hook the loops over the harness mounting points inside the helmet.
8. Hook the inner set of skirt loops over the harness mounting point and outer loops. Repeat with the loops on the other end of the sealing skirt.

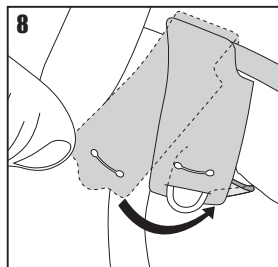
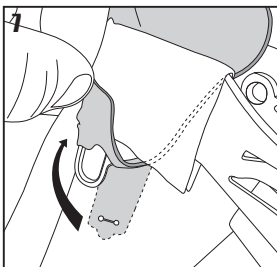
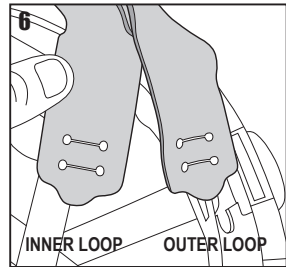
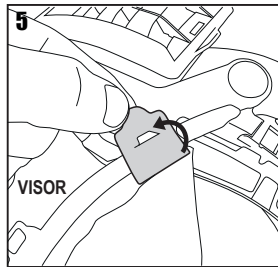
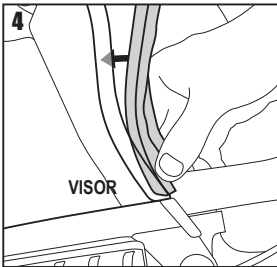
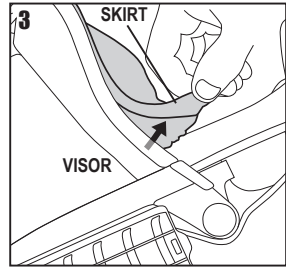
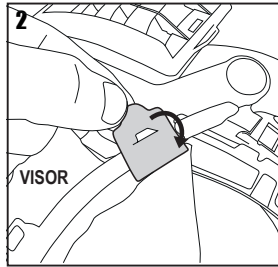
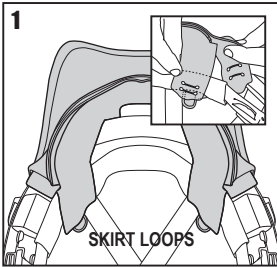

REMOVING & REPLACING THE DRIVE UNIT & VISOR CARRIER ASSEMBLY:



See *Battery & Airflow Check*, *Removing & Replacing Filters*, *Removing & Replacing the Visor* and *Removing & Replacing the Face Seal Skirt* sections to remove the battery cable, filters, visor and skirt.

1. To release the visor carrier, press the rear of the visor side arms on both sides of the helmet towards the helmet shell and slide forwards.
2. When replacing the drive unit & visor carrier assembly, simply slide the visor side arms back into the visor carrier adaptors on both sides of the helmet. Dispose of used drive unit & visor carrier assembly in accordance with local legislation.

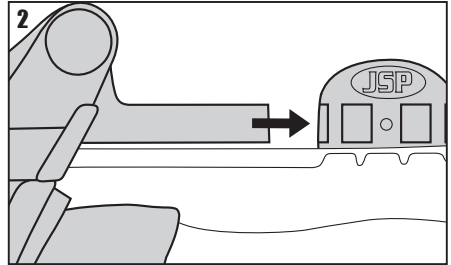
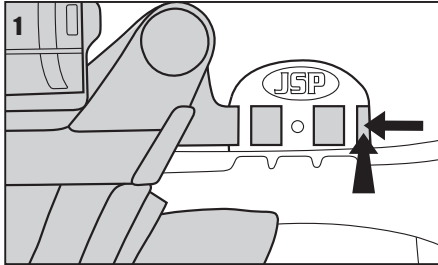

REMOVING & REPLACING THE VISOR COVER:



1. Peel used visor cover from visor. Dispose of used visor cover in accordance with local legislation.
2. Peel backing tape from either side of the new visor cover.
3. Position visor cover centrally, using the side of the hand, smooth visor cover on to visor and press adhesive tape in place. Repeat for the other side.

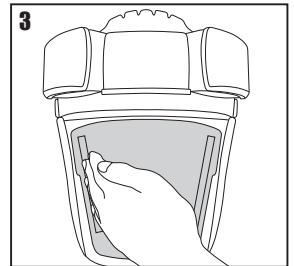
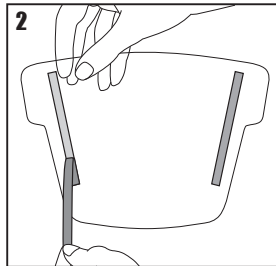
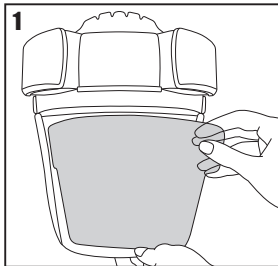

REMOVING & REPLACING THE HARNESS STRAP:



1. Unhook the four inner and outer face seal skirt loops from the harness mounting points inside the helmet.
2. Remove the harness strap by un-popping the arm from the receiver (hold the helmet and receiver firmly whilst doing so).
3. Repeat this process for all 4 arms then take the harness strap out from the helmet. Dispose of used strap in accordance with local legislation.
4. Place the replacement strap inside the helmet shell, then pop the first arm back into position and repeat the process for all 4 arms.
5. Feed the outer set of skirt loops behind the harness strap inside the helmet. Hook the loops over the harness mounting points inside the helmet.
6. Hook the inner set of skirt loops over the harness mounting point and outer loops. Repeat with the loops on the other end of the sealing skirt.
7. The foam blocks must be exposed as shown in figure 7.

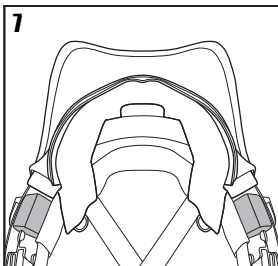
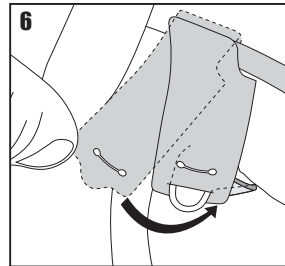
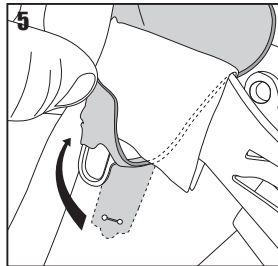
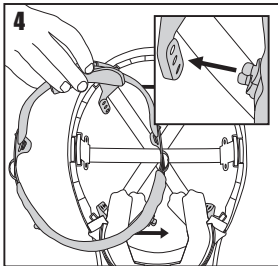
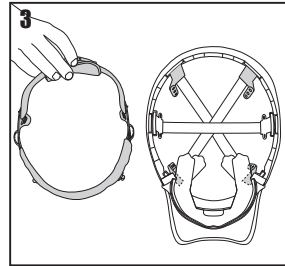
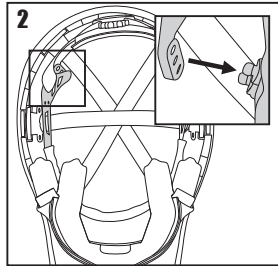
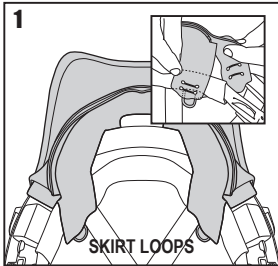

SAFETY PRECAUTIONS:

PowerCap® Infinity® should be used in situations where the requirements for AS/NZS1716:2012, AS/NZS1801:1997 and AS/NZS1337.1 protection applies.

- This apparatus must not be worn in the hazard zone with the drive unit switched off.
- When switched off a build up of carbon dioxide and depletion of oxygen may occur.
- When switched off no respiratory protection is provided; this is considered to be an abnormal running condition.
- The apparatus should not be used in oxygen deficient atmospheres.

The user is advised that when in contact with the wearer's skin, the unit may cause allergic reactions to susceptible individuals. If this is the case the wearer should leave the hazard area, remove the unit and seek doctor's advice.

- The apparatus is NOT suitable for protection against gases and vapours. • The apparatus should not be used in an atmosphere immediately hazardous to life or health. • At high work rates the pressure in the device may become negative at peak inhalation flow. • Using the apparatus in high wind velocities may affect filtering efficiency. • Only use genuine PowerCap® Infinity® filters supplied in pairs from JSP Ltd or its distributors.
- Do not lift the visor whilst in the hazard zone. • Do not expose PowerCap® Infinity® to flames or sparks. • Do not use PowerCap® Infinity® in confined spaces or areas of poor ventilation. • Do not alter or modify the product in any way not approved by JSP Ltd. • Do not touch any moving part. • Do not allow water or other liquids to enter the inside of the motor housing or battery compartment. • Care should be taken to avoid the possibility of the power cable from the battery pack to drive unit becoming caught up in use.

ADDITIONAL INDUSTRIAL SAFETY HELMET INSTRUCTIONS:

Fitting and adjustment: Fit the helmet as described in the PowerCap® Infinity® *Donning* section of this manual. For adequate protection PowerCap® Infinity® must fit or be adjusted to the size of the user's head.

Use: The helmet is made to absorb the energy of an impact by partial destruction or damage to the shell or harness and even though such damage may not be readily apparent, any helmet subjected to severe impact should be replaced. This helmet has been designed to protect the wearer against electrical shocks by preventing passage of dangerous current through the body via the head. The helmet must be used with other insulating protective equipment when working on low voltage installations. The user should check that the electrical limits of the helmets correspond to the nominal voltage that is likely to be encountered during use. Accessories and/or replacement components are available with fitting instructions from JSP.

Inspection and care of the helmet: The helmet is a complete system consisting of shell and harness. The helmet's useful life is affected by many factors including the cold, heat, chemicals, sunlight and misuse. The helmet should be examined daily for obvious signs of cracking, brittleness or damage to either helmet or harness. The user should be aware that there is potential risk of loss of protection due to ageing and/or inappropriate cleaning. The effectiveness of the insulating properties of the helmet may be affected by the conditions of use. The date of manufacture is moulded into the peak of the helmet. While the helmet is free from defects it is suitable for its intended purpose. If in any doubt destroy the helmet.

Useful life: Under normal circumstances the helmet has a maximum life of 5 years from date of manufacture. Under no circumstances must a component other than a JSP component be used on a JSP helmet.







ADDITIONAL INDUSTRIAL EYE PROTECTION INSTRUCTIONS:

Assembly: The PowerCap® Infinity® visor should be fitted to, and used with the PowerCap® Infinity® visor carrier and helmet, see fitting instructions in the *Removing & Replacing the Visor* section of this manual.

Useful life: Under normal circumstances the visor should offer protection for up to 5 years. Scratched or damaged visors should be replaced. Replacement visors are available.

MARKINGS:

MARK	MEANING
AS/NZS 1716	Australian standard for respiratory protection devices
PAPR-P2	Indicates a 99% efficiency with a WES of up to 50
AS/NZS1801	The Australian standard for occupational protective helmets
EN50365:----	The European standard number for electrically insulating helmets for use on low voltage installations and its year of publication
EN397:----	The European standard number for industrial safety helmets and its year of publication
	The double triangle symbol means that this helmet is electrically insulated for use working live or close to live parts on installations not exceeding 1000Vac or 1500Vdc
53-63 cm	The size range of the helmet, head circumference
-20°C / -30°C / -40°C	The helmet will provide some protection when worn in an environment at or above these temperatures
MM	The helmet will provide some protection against molten metal splash
440 Vac	The helmet will protect the user against short term, accidental contact with live electrical conductors up to a voltage of 440 Vac
LD	The helmet will provide some protection from lateral compressive loads

MARK	MEANING
EN166:2001	European standard for protective eyewear
2-1.2	Shade number
1	Optical quality (high)
B	Protection against medium energy impact against high speed particles
8	Protection against short circuit electric arc
9	Protection against molten metals and hot solids
K	Resistance to surface damage by fine particles
AS/NZS1337.1	The Australian standard for personal eye protection, eye and face protectors for occupational applications
O	Outdoor un-tinted
V	High Impact
M	Molten metal and hot solids
	See instructions for use. If the instructions for use recommendations are not adhered to, the protection afforded by the device may be severely impaired.
	Storage temperature and humidity ranges
	Indicates conformity to European Legislation 2016/425
	Dispose of in accordance with local legislation
	Some of the components of the device can be recycled
	Date of manufacture
	Use by date

WARRANTY:

JSP Ltd warrants to its customers of PowerCap® Infinity® that the device will be free from defects in materials and mechanical or electrical defects for a period of 24 months from date of purchase. This warranty is subject to:

- PowerCap® Infinity® being used solely for the purpose for which it is intended.
- PowerCap® Infinity® not being subject to misuse, damage, modification or repair.
- The user must register the product to enact this guarantee.

To register the product, visit www.jspwarranty.com

JSP Ltd will replace defective parts as required at no charge. JSP Ltd's liability will not exceed the value of the original sales receipt for the device. In the event of valid claims under this warranty JSP Ltd will not be liable for loss of use of any of its products or for any incidental, indirect or consequential cost, expenses or damages incurred or claimed by the purchaser or any other user. No other terms are implied by this warranty but a purchaser's statutory rights are not affected. To make a claim under this warranty, please contact the retailer from which the PowerCap® Infinity® was purchased.

BATTERY INFORMATION:

Battery Type: Lithium-ion 3.6V, 5.2Ah, 18.72 Wh. The battery has an expected life of 500 cycles when charged, stored and used in accordance with these instructions.

- Operating temperature should be between +5°C and +40°C and relative humidity not greater than 75%.
- The temperature for charging and discharging of the battery should be between +5°C and +40°C.
- Do not dismantle, tamper, open or shred the battery pack.
- Do not expose the battery pack to heat, fire or microwaves. Avoid storage in direct sunlight.
- Do not short-circuit the battery pack. Do not place the battery pack haphazardly in a box or drawer where it may short-circuit with another or be short-circuited by other metal objects?
- Do not remove the battery pack from its original packaging until required for use.
- Do not subject the battery pack to mechanical shock.
- In the event of the battery pack leaking, do not allow the liquid to come in contact with the skin or eyes. If contact has been made, wash the affected area with copious amounts of water and seek medical advice.
- Do not use any charger other than that specifically provided for use with the PowerCap® Infinity®.
- Do not use any cells or batteries which are not designed for use with the PowerCap® Infinity®.
- PowerCap® Infinity® is not intended to be used by children, children should not be left unsupervised with PowerCap® Infinity® or its battery pack.
- Seek medical advice immediately if parts of a dismantled battery pack have been swallowed.
- Only replacement battery packs intended for the PowerCap® Infinity® are recommended by JSP Ltd for use with PowerCap® Infinity®.
- Keep the battery pack clean and dry.
- Wipe the battery pack terminals with a clean dry cloth if they become dirty.
- The PowerCap® Infinity® battery pack needs to be charged on initial receipt from purchase to ensure a full compliment of charge. An 8 hour charge is recommended. Always use the correct charger supplied with PowerCap® Infinity® and refer to the user instructions for the correct charging procedure.
- Do not leave a battery pack on prolonged charge when not in use.
- After extended periods of storage, it may be necessary to charge and discharge the battery pack several times to obtain maximum performance.
- Retain the original user instructions for future reference.
- The battery pack is only intended for use with the PowerCap® Infinity®, it is not suitable for any other application.
- When possible, remove the battery pack from the equipment when not in use.
- Dispose of exhausted battery packs in accordance with local legislation.

CLEANING:

The product should only be cleaned with a cloth lightly dampened with a mild detergent and non-aggressive solution. Care must be taken to avoid any liquids entering the motor/fan assembly or the filters. The elements of PowerCap® Infinity® should be cleaned as detailed below:-

Pre-filter cover – wipe clean using a soft cloth, run under a tap and allow to dry.

Filter Case – remove and wipe down with a damp cloth.

Visor – refrain from rub rinsing, simply rinse and pat dry with a non abrasive cloth.

Helmet – wipe down with a damp cloth.

Face Seal Skirt – machine or hand wash in mild detergent at 30°C. Leave to dry naturally (Do NOT dry on a heat source or hang by skirt tabs when wet). Do not allow water or other liquids to enter the inside of the drive unit or filters. Do not use solvents or abrasive cleaners on any part of PowerCap® Infinity®.

ACCESSORIES:



Hearing protection can be added to the PowerCap® Infinity® by fitting the Sonis® helmet mounted ear defenders. The Sonis® range of helmet mounted ear defenders and the PowerCap® Infinity® have been designed to be compatible. Use of non-compatible hearing protection may reduce the performance of PowerCap® Infinity®. Contact JSP Ltd to check compatibility of other hearing protection/accessories.







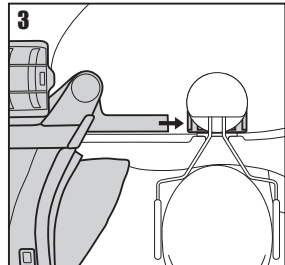
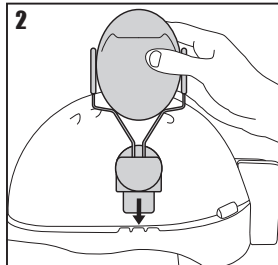
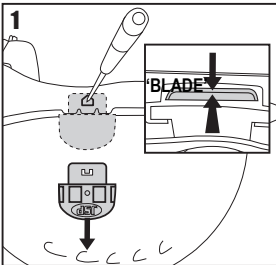



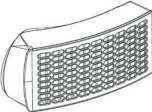
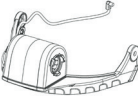
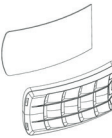

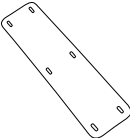
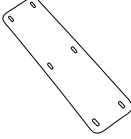

Fitting the Sonis®:

Remove the PowerCap® Infinity® visor complete with the PowerCap® Infinity® drive unit & visor carrier assembly. Unhook the sealing skirt from the harness (see *Removing & Replacing the Visor*) and disconnect the power cable from the battery box (see *Battery and Airflow Check*). To remove the visor carrier, press the rear of the visor side arms towards the helmet shell and push forwards. (see *Removing & Replacing the Drive Unit and Visor Carrier Assembly*).

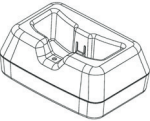
1. Remove the visor carrier adaptors from the helmet shell. Inverting the helmet, push the adaptor blade towards the outside of the helmet and then down. Insert a ball point pen or similar into the hole in the side of the helmet shell, at the same time press the adaptor blade whilst pulling from shell as shown.
2. Fit the ear defender as the instructions supplied with the ear defender of your choice.
3. Once the ear defenders are fitted, slide the visor side arms into the slot on the ear defender helmet adaptor.
 - Ensure that the face seal skirt is correctly attached as stated in *Removing & Replacing the Visor*.
 - When donning the helmet, adjust the ear defenders as stated in user instructions supplied with the ear defender. Ensure that both the ear defender and the PowerCap® Infinity® are correctly adjusted and comfortable. Failure to do so may result in the levels of protection offered by either or both products being severely reduced.



REPLACEMENT PARTS:

REPLACEMENT PARTS	PRODUCT CODE	IMAGE	REPLACEMENT PARTS	PRODUCT CODE	IMAGE
PowerCap® Infinity® Filters (Pair)	CAU660-000-4AN		PowerCap® Infinity® Twin-Turbo Drive Unit and Visor Carrier Assembly	CEU120-001-300	
PowerCap® Infinity® Pre-Filter (5 Pairs) and Pre-Filter Covers	CEU100-006-500		PowerCap® Infinity® Battery Pack	CEU170-000-000	
PowerCap® Infinity® Pre-Filter (50 Pairs)	CEU150-000-000		PowerCap® Infinity® Replacement Cable Clip (10 Pack)	CEU210-001-100	
Replacement Black Self-Adhesive Foam Elastomer Seal (10 Pairs)	CEU220-001-100		PowerCap® Infinity® Face Seal Skirt	CEU180-000-000	
4mm Brushed Nylon Foam Sweatband (Black)	AJA 830-001-100		Chamlon Sweatband (10 Pack)	AJA 840-000-200	
PowerCap® Infinity® Visor	CEU110-001-300		PowerCap® Infinity® Charge Dock and Power Supply	CEU130-001-100	
PowerCap® Infinity® Peel Off Visor Protectors (10 Pack)	CAU180-000-000		PowerCap® Infinity® Airflow Indicator Test Unit	CEU140-001-100	
Black* EVO®5 Helmet for PowerCap® Infinity® *Other colours available on request	AKG179-P01-100		PowerCap® Infinity® Carry-Case	CEU170-001-100	
Helmet Harness Strap	CEU190-000-000		PowerCap® Infinity® Replacement Hygiene Bag (10 Pack)	CEU230-000-000	



**POWERCAP
INFINITY**



BSI BMP No.
689733

www.jspsafety.com

RFPZ-005-800-19-11



JSP Safety GmbH
40549, DE

JSP Ltd
OX29 0TA, UK
technical@jpsafety.com | +44 1993 826051



BSI BMP No. 689739
Certified by: BSI Group
7/15 Talavera Road, Macquarie Park,
NSW 2113, Australia

Copyright © 2019. JSP Ltd. All Rights Reserved.