



TX8005 Air XD Group I Hazardous Locations
Real-Time Dust Monitor



TROLEX«

User Manual

TX8005 AIR XD Grp I Hazardous Locations

Contents

1.	General Description	4
1.1	Main features	5
1.2	Performance Data	5
1.3	Intended Use.....	6
1.4	Limits of Use.....	6
2.	Product Safety	7
3.	Danger from Process	8
4.	Safety Procedures	8
4.1	Laser Safety Precautions.....	9
5.	System Components.....	10
5.1	TX8005 Group I Air XD Particulate Monitor	11
5.2	Particulate Flow Path.....	12
5.3	TX8805 Air XD USB Drive	13
5.4	Peripherals and Accessories.....	14
6.	Certification and Conformity.....	16
6.1	Underground Mines	16
6.2	Conditions of use:	17
7.	Technical information.....	18
7.1	Product Options	18
7.2	Product Specification	18
7.3	Product Dimensions	20
8.	Hardware Installation	21
8.1	Safety Precautions	21
8.2	Mounting Details	21
8.3	Main Parts	22
8.4	Electrical Connections	23
8.5	I/O Terminals.....	24
8.6	Power Connections	24
8.7	RS485 – Output Signals	25
8.8	RS485 – Line Terminations	25
9.	Commissioning.....	26
9.1	First Power On	26
9.2	Application Software	26
10.	Controls and Indicators	27
10.1	Navigation.....	27
10.2	Main Function Keys	28
10.3	Short-cut Functions.....	30
11.	General Operation.....	31
11.1	User Interface Display.....	31
11.2	PM Value Display Map.....	32
11.3	Settings Structure	33
11.4	PM Settings.....	34
11.5	Setting custom PM values.....	34
11.6	PM Density.....	35
11.7	Averaging Settings	35
11.8	Alarm Settings.....	36
11.9	Channel Select.....	37
11.10	Threshold Channel	37
11.11	Set Alarm Threshold.....	38
11.12	Alarm Latching.....	38
11.13	Alarm Enable/Disable.....	39
11.14	4-20mA Outputs.....	39
11.15	Select PM Channel	40
11.16	Map 4-20mA to Data Channel	40
11.17	Set Max PM Value.....	40
11.18	Enable/Disable.....	41
11.19	Status	41
11.20	Communications.....	42
11.21	Ethernet Communications.....	42
11.22	Network Status	42
11.23	IP Settings.....	42
11.24	Ethernet Operating Mode	43

11.25	Ethernet Connection Status.....	43
11.26	RS485 MODBUS Communications.....	44
11.27	Set Baud Rate.....	44
11.28	Set Device Address.....	44
11.29	Display.....	45
11.30	Adjusting Display Contrast.....	45
11.31	Set Display Backlight.....	45
11.32	Set Display Colour.....	46
11.33	Set Display Sleep.....	46
11.34	Date & Time.....	47
11.35	Set Date.....	47
11.36	Set Time.....	47
11.37	System.....	48
11.38	System Information.....	48
11.39	Restart Controller.....	48
11.40	Data Download.....	49
11.41	Memory Module.....	50
11.42	Firmware Update.....	51
12.	Instrument Configuration.....	52
12.1	Default Settings.....	52
12.2	On-Site Configuration.....	52
12.3	MODBUS Addresses.....	53
12.4	Coil Register.....	55
12.5	Holding Register.....	56
12.6	Instrument Self-Test.....	57
13.	Maintenance.....	58
13.1	Visual Checks.....	58
13.2	Cleaning Labels.....	58
13.3	Particulate Entry/Exit apertures.....	58
14.	Troubleshooting.....	59
14.1	High Temperature operating.....	59
14.2	Low Temperature Start-up.....	59
14.3	Fault Codes.....	60
15.	Glossary and Definitions.....	61
16.	Disposal.....	61
16.1	Waste of Electrical and Electronic Equipment (WEEE) Directive (2012/19/EU).....	61
17.	Technical Support.....	61
18.	Disclaimers.....	62
19.	Revisions.....	62
20.	Feedback.....	63
21.	Trademarks.....	63

1. General Description

The Trolex Group I Air XD particulate monitor is designed to provide detailed, accurate, real-time data on airborne particulates so that users can take appropriate actions to stay safe and ensure personnel are fully protected from particulate-related health hazards. The Air XD allows users to simultaneously monitor multiple Particulate Matter (PM) sizes (PM1.0, PM2.5, PM4.25, PM10 as well as custom) and can report on Total Suspended Particulates (TSP). Precise data is collected for measurable particulates, enabling detailed size profiling and analysis using the application software.

The Air XD uses an innovative Optical Particle Counter (OPC) that combines adaptive particle flowrate with advanced sensing technology to ensure a high level of measurement accuracy. The size of each particle is instantaneously measured and classified at up to 10,000 samples a second to allow detailed real-time reporting in high dust environments.

As the Air XD records live data on all particulates between 0.35µm and 40µm, users can easily access and view detailed information about a wide range of PM sizes. Measurement information can be viewed via the instrument display or as a live or historical readings using the application software.



TX8005 Group I Air XD

1.1 Main features

- Real-time continuous measurement of atmospheric dust concentration
- High-reliability, low-maintenance for high-dust environments
- High capacity Optical Particulate Counter (OPC)
- Industry Standard sizing PM1.0, PM2.5, PM4.25 and PM10
- Low-end resolution, measuring down to 0.35µm with 99.9% capture
- Ability to display Total Suspended Particles (TSP) measurement reading
- Quantification of particle size categories to customer requirements (Custom sizing)
- Operational stability in varying environmental and atmospheric conditions
- On-device display readout
- Choice of display modes, 'Live' readout or configurable 'Averages'
- Two configurable relay output contacts for remote alarms and control functions
- Two 4-20mA analogue output signals of measured averages
- Remote RS485 MODBUS RTU Serial I/O interface
- Ethernet MODBUS TCP/IP output
- High visibility alarm warning indicators
- Plug and play installation

1.2 Performance Data

Using current advancements in light scattering techniques combined with patented data processing algorithms, the Air XD is able to achieve levels of accuracy (+/-5%) normally only found in high-end laboratory instruments.

1.3 Intended Use

The Air XD is a particulate monitor designed for use in range of hazardous applications and environments. The instrument is suitable for monitoring in either indoor or outdoor ambient air conditions and can cope with both high and low particulate concentration levels (up to 1500 mg/m³). The instrument is designed to be low maintenance and does not use pumps or filters. The sensing element has an adaptive flowrate to increase accuracy in environments with varying airflow.

1.4 Limits of Use

To ensure the optimum performance and safe operation, the Air XD must be operated as per the limits detailed in the technical data section of this user manual. Operation outside these limits may result in damage to the equipment or failure to achieve the performance specification.

Continual operation of the Air XD at extremes of the specified temperature limits may reduce the operating lifetime of the product.

Troxel will not be liable for any injury or damage caused by incorrect installation, setup, operation or maintenance resulting in a failure to follow the procedures and safety instructions provided in this user manual.

2. Product Safety

The following symbols are used in this manual or on the instrument to indicate procedures that, if not followed correctly, may result in personal injury or damage to equipment.



WARNING!

Alerts the user to a potentially hazardous procedure or practice which, if not followed correctly can result in serious personal injury or injury of others.



CAUTION!

Alerts the user to a procedure or practice which, if not followed correctly, can result in damage to the system or ancillary equipment.

In addition, the following symbols are used on the instrument:



WARNING! – ELECTRIC SHOCK RISK



WARNING! – LASER RADIATION

The use of controls, adjustments or procedures other than those specified in this user manual may result in exposure to hazardous optical radiation.

3. Danger from Process

It is possible that the Air XD could be installed in environments that contain process particulates which can be hazardous to health. These may take one or more of the following forms:

- Particulate that is inflammable or explosive
- Particulate which is toxic or some way hazardous to health

Unless process conditions are known to be entirely safe, suitable precautions such as the use of breathing apparatus or environmental purging/detoxifying should be employed before entry is made into the installation or maintenance environment.

4. Safety Procedures

Always observe the safety precautions detailed in this user manual. Personnel installing, operating or maintaining the equipment are responsible for their personal safety and correct handling of the equipment in accordance with all safety instructions detailed.

Follow all warnings and instructions marked on the instrument. Warning labels are situated on the instrument, indicating a hazard at or near the location of the warning label.

Retain these instructions in a safe and known place for future use.

The Air XD has been designed to be as simple to install and commission as possible. Nevertheless, installation in working environments can be challenging and correct set up is critical to the function of the instrument. It is important that you carefully read the entire User Manual before using and installing the Air XD for the first time and keep it in a safe place for future reference.

Refer to the following standards for additional guidance:

- IEC/EN 60079-14
- IEC/EN 60079-25

Peripheral components such as the power supply and communications module/peripheral or interface must be installed according to the manufacturer's instructions and the installation location's prevailing statutory regulations.

The installation of the instrument must only be carried out by competent personnel. Each installation needs to be considered with reference to the local safety regulations and authorities.

Refer to the Certification and Conformity section of this User Manual and to the relevant certificates for any installation parameters and special conditions of safe use.

Observe the national safety regulations issued, for example, by the employers' liability insurance association, social security institutions, occupational safety and health authorities or other safety organisations.

4.1 Laser Safety Precautions

The Air XD is rated via the Class 1 Laser safety guideline under all conditions of normal use.

Class 1 laser products may contain laser systems of a higher class but there are adequate engineering control measures to ensure that access to the beam is not permitted during normal use.

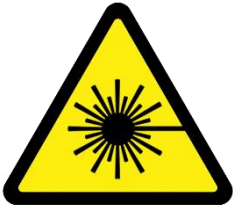

WARNING - Class 3B laser radiation when the laser housing is open, do not open the laser housing. Eye damage may result from the direct viewing of the laser beam.

The Air XD complies with:

- IEC 60825-1 2014
- 21 CFR-1040.10 and 1040.11

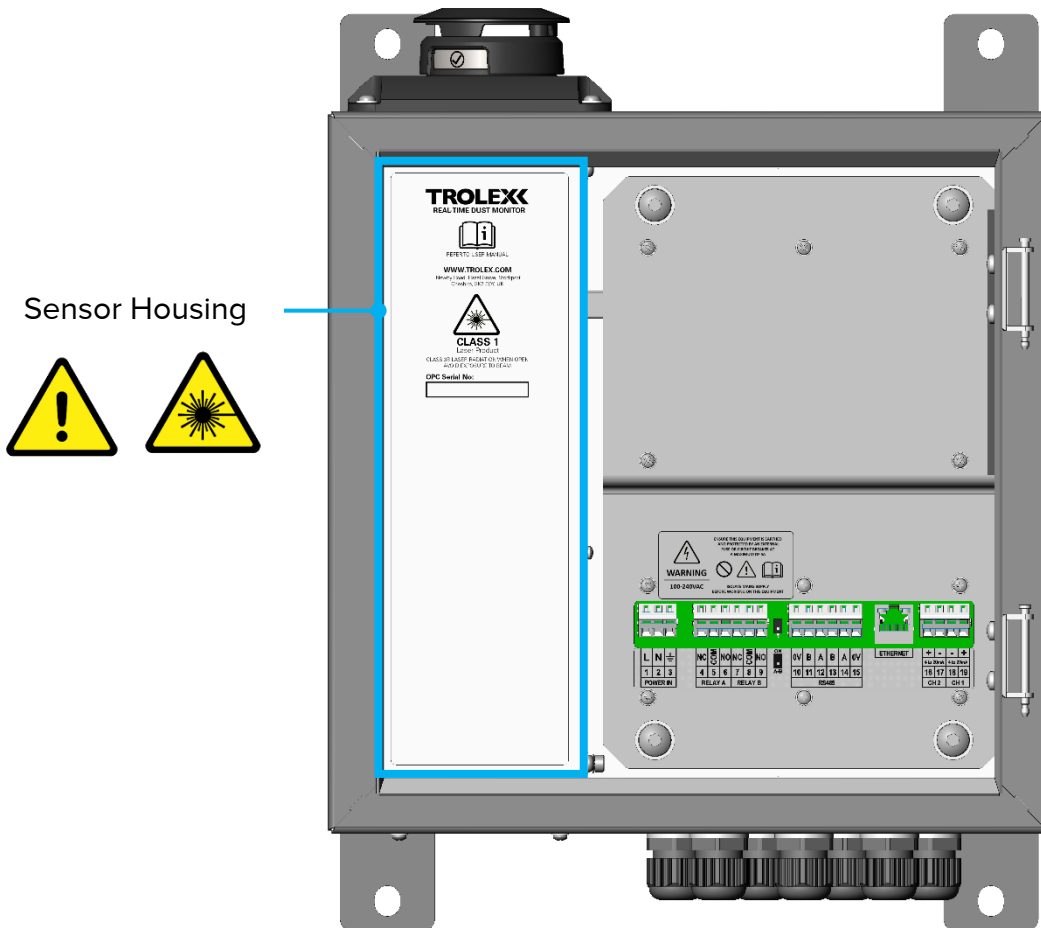

WARNING: There are no user serviceable parts inside the Air XD sensor housing. Servicing should only be carried out by Trolex or an approved service technician.

5. System Components

The Air XD is typically installed as a stand-alone instrument for Group I underground mines and industrial applications. The instrument is supplied with peripherals fitted to allow for the plug and play installation to IS power supplies, interface barriers and data outputs.

The Air XD instrument and Air X software are specifically designed to work in conjunction with each other using proprietary protocols and design features. The system has also been designed to support 3rd party power supplies and communication protocols where required.

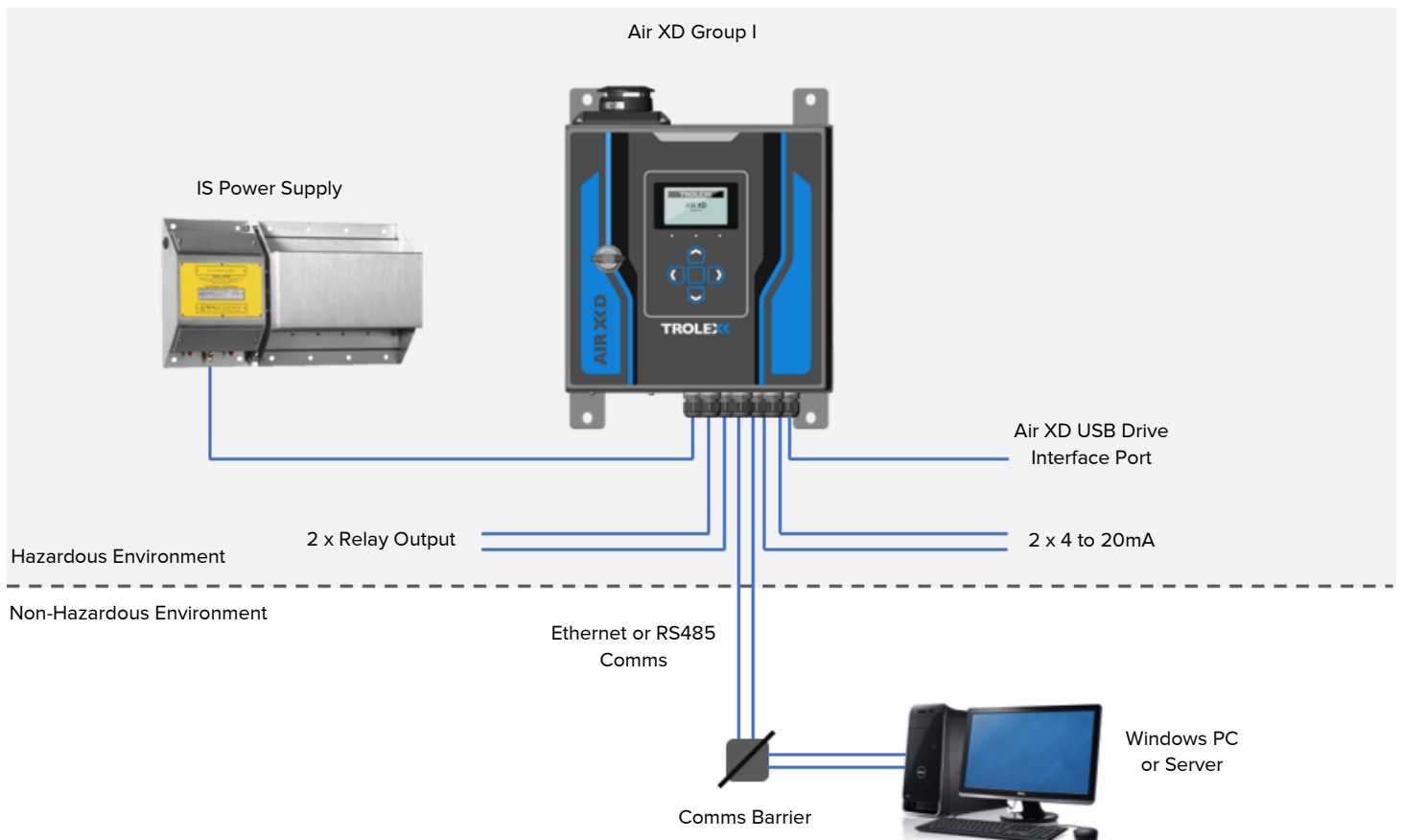

Example installation configuration

Note: M20 gland entries are provided for custom installation requirements. Gland entries may be blanked, and installations may vary from diagram shown.

5.1 TX8005 Group I Air XD Particulate Monitor

The Air XD Particulate Monitor uses an Optical Particle Counter (OPC) that is located inside a robust stainless-steel housing. This provides isolation and ingress protection between the particle flow path and the main control circuits. Control circuits are housed in a lockable, IP66 rated coated steel enclosure. Information and settings can be accessed using the keypad and display located on the front of the instrument.

The Air XD can be configured to report on PM size concentrations or TSP based on user requirement, with the option of two configurable setpoint relay outputs. Detailed information can be transmitted via an RS485 or Ethernet connection to a computer running the accompanying application software or downloaded directly from the internal memory module using the certified Air XD USB storage drive.

The figure below shows the location of the navigation buttons, display screen and status LEDs. Power and network connections enter the main housing via cable entry glands located on the bottom of the instrument. The Air XD can be wall or stand mounted via mounting brackets.

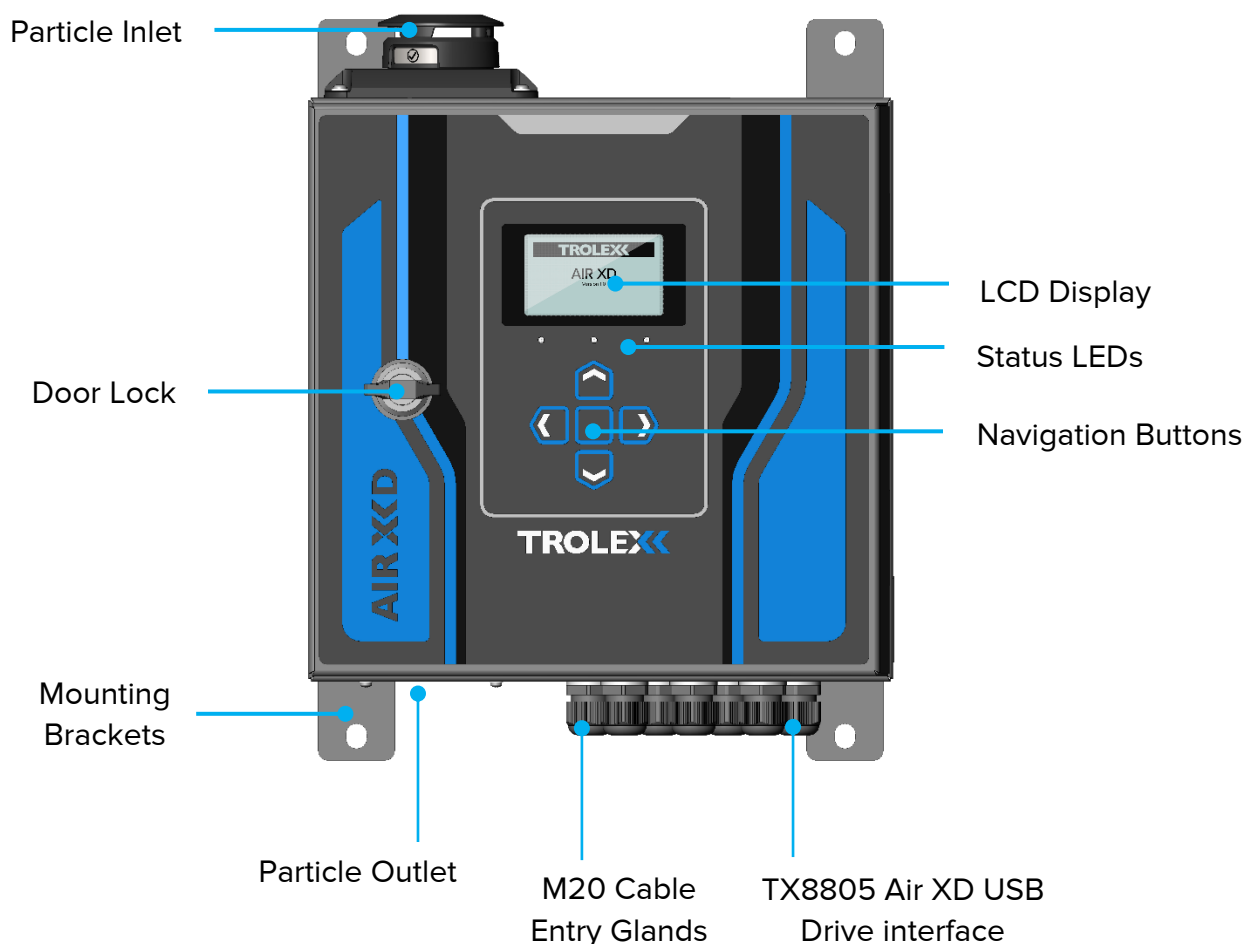

5.2 Particulate Flow Path

The Air XD has been designed with the ability to restrict ingress through the particulate flow path during routine maintenance and cleaning periods. A rotational top cap is used to open or close the particle flow path to provide increased ingress protection during cleaning.

It is recommended that the top cap is set to the closed position during instrument maintenance and cleaning to ensure the dust sensor is not exposed to unnecessary ingress. When the top cap is rotated into the closed position, the Air XD conforms to IPX6.

The Air XD can detect whether the flow path is open or closed and will record top cap positions to aid with instrument maintenance schedules.

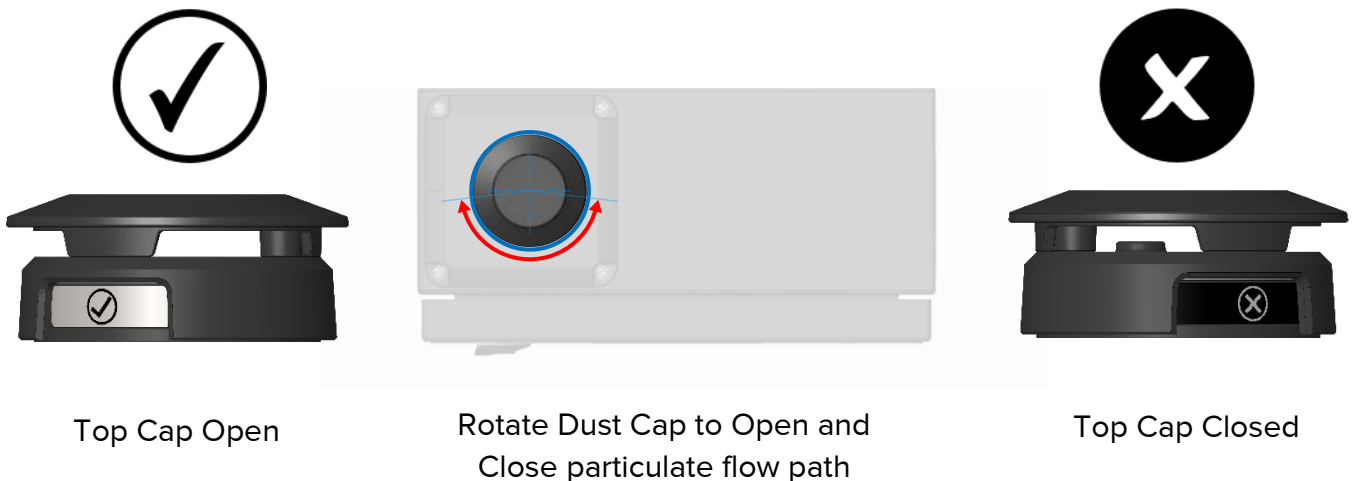

5.3 TX8805 Air XD USB Drive

The Air XD USB Drive is designed to allow for the local download of recorded data within the hazardous environment from the Air XD. 8GB of memory is housed within a fully sealed enclosure which is encapsulated to meet IP66 requirements.

Once the download of data is complete from remote or isolated Air XD devices, the USB Drive can be locally connected to a surface PC for transfer and interrogation of the data using the Air XD application software.

The USB Drive is externally connected to the Air XD instrument without the need to open the enclosure door via an IP66 M20 Panel Mounted USB bayonet connector located on the underside of the device. The Air XD USB Drive is not designed to be permanently connected to the Air XD and must be removed after data download/upload is complete. To ensure that IP integrity is maintained, IP protection caps must be replaced onto each USB connector shell after use.

Note: The Instrument USB port operates at 4V, do not connect any other USB device to the Air XD when located in a hazardous environment. USB drives with no power source (e.g. standard USB stick) may be connected to the USB connector in the safe area for test purposes etc. Not all USB drives will operate or be compatible with the Air XD instrument due to operational voltage differences.

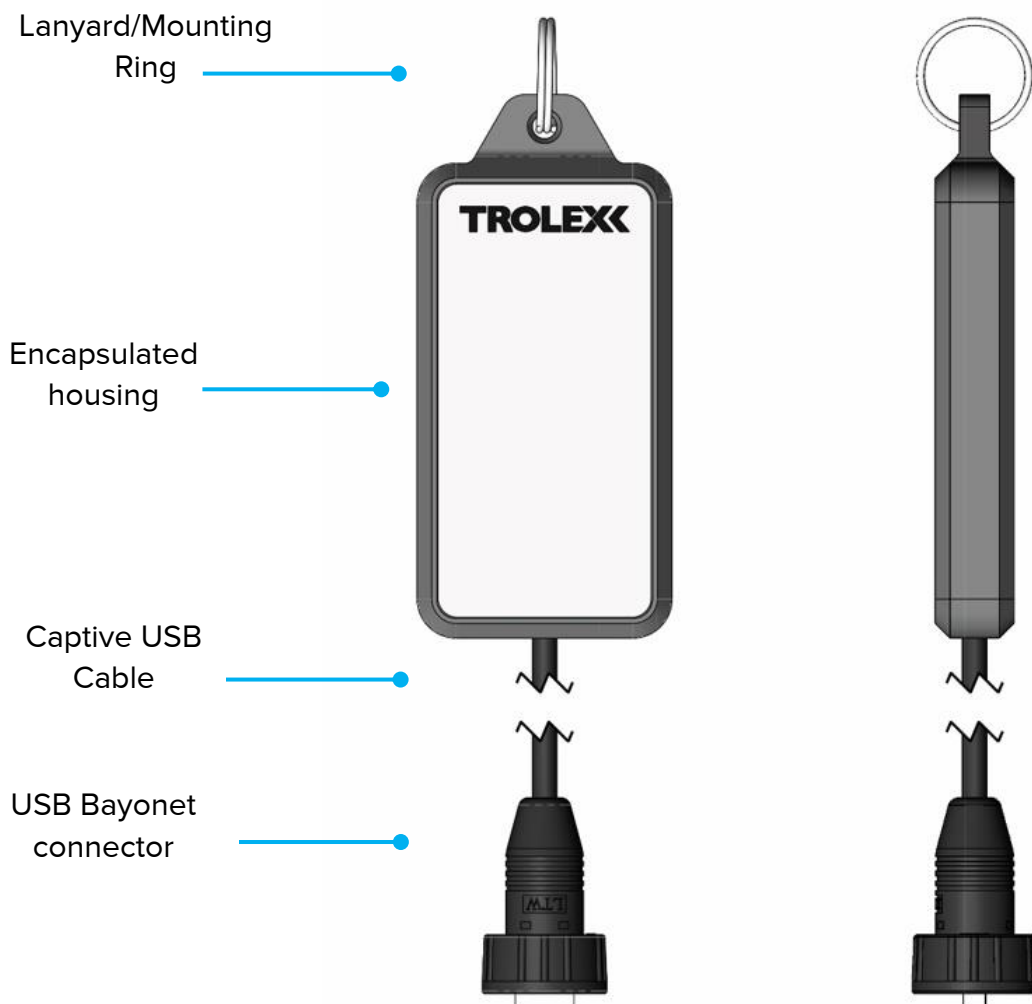

5.4 Peripherals and Accessories

Power supply

The Air XD must only be connected to an approved Intrinsically Safe (IS) 12 V DC power supply approved for use in hazardous locations.

Ethernet Barrier

Use of an approved Intrinsically Safe (IS) isolating Ethernet barrier is required to connect an Air XD device operating in the hazardous environment to a mine Ethernet network. Suitable hardware can be provided on request.

RS485 Barrier

Use of an Intrinsically Safe (IS) RS485 barrier is required to connect an Air XD device operating in the hazardous environment to a mine network. Converters are also available to allow integration with Ethernet communications. Suitable hardware can be provided on request.

Windows PC or Server

A Windows PC or server is required to run the Air X application software (required to collect and process data from the Air XD instrument).

It is recommended that client computers meet or exceed the following system requirements, before installing the Air XD application software. This applies to both dedicated hardware and virtual machines. Other configurations may work but cannot be guaranteed.

CPU	Intel® Core™ i5-6300U CPU @ 2.4GHz
RAM	8GB (minimum)
Disk Space	20GB recommended (Data capture dependent)
Communications	DB9 Serial Port or USB Serial Port and Ethernet Port
Operating System	Windows 10

5.5 Air X Application Software

Data transmitted to a PC or server is collected, stored and processed using the Air X application software. The instrument communicates with the Air X software using MODBUS RTU (RS485).

The Air X application software can be used to monitor in real-time or review historical data. It allows user to monitor instrument information, graph live data sets and monitor alarms.

Note: Operating instructions for the application software are provided in a separate user manual.

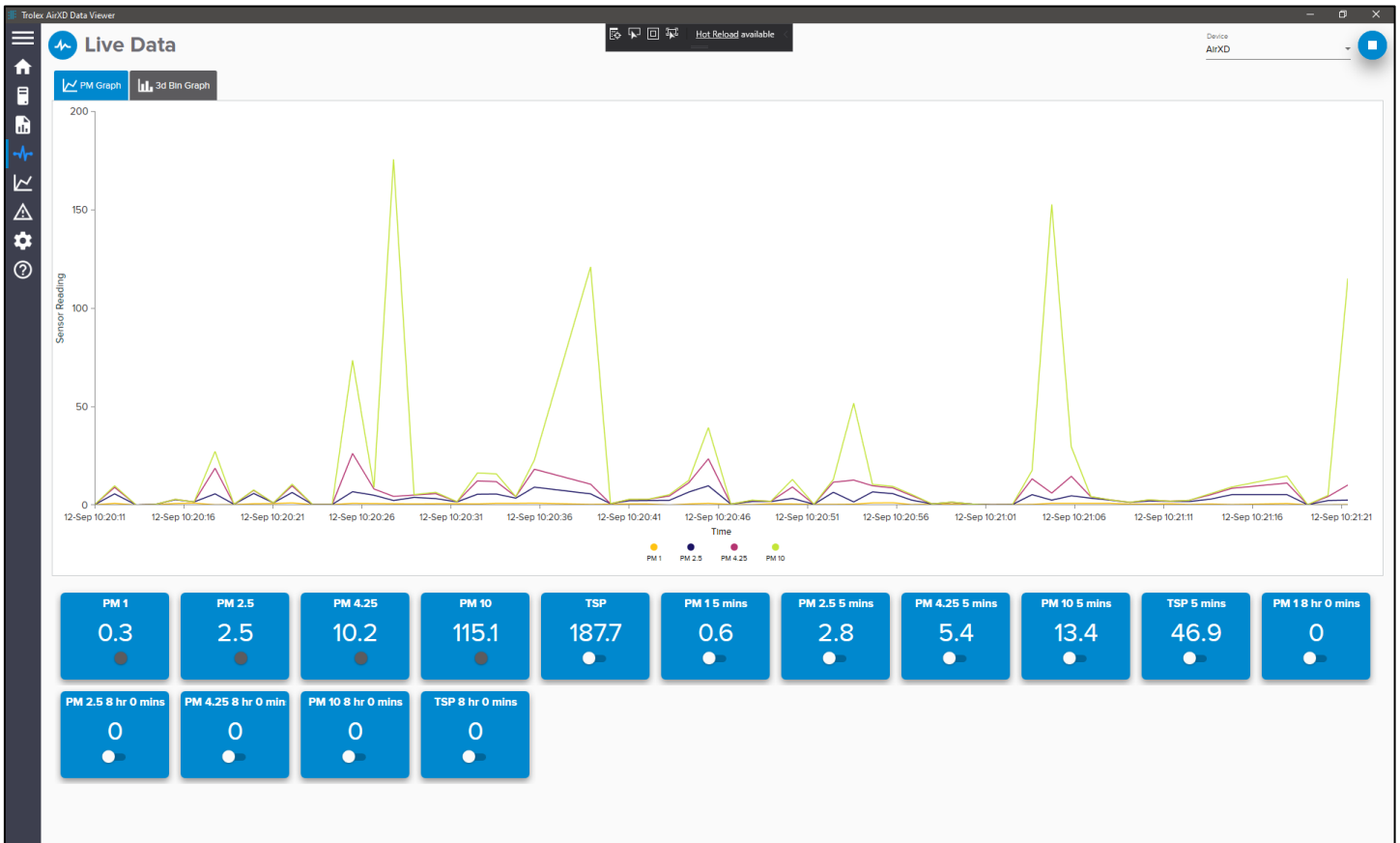

6. Certification and Conformity

	IECEX (International) certification for use in underground mines in Australia (including Queensland) and New Zealand.
	Standards: IEC 60079-0:2017 Edition 7.0 IEC 60079-11:2011 Edition 6.0 IEC 60079-28:2015 Edition 2.0

	ATEX certification for use in underground mines in European Union.
	Complies with the following EU Directives: ATEX Directive 2014/34/EU - EN IEC 60079-0:2018 - EN 60079-11:2012 - EN 60079-28:2015 EMC Directive 2014/30/EU - EN 61326-1:2013 - EN 61000-6-2:2019 - EN 61000-6-3:2007+A1:2011 RoHS Directive 2011/65/EU

6.1 Underground Mines

Equipment / Product Code	Ex Certificate Number	Ex Certification Code
Air XD TX8005.06(.XX...)	IECEX ExTC 19.0014X	Ex ia op is I Ma -20 °C □ Ta □ +50 °C
Air XD USB Drive TX8805.06(.XX...)		Ex ia I Ma -20 °C □ Ta □ +50 °C

Equipment / Product Code	Ex Certificate Number	Ex Certification Code
Air XD TX8005.19(.XX...)	IECEX ExTC 19.0014X TÜV 19 ATEX 8468 X	I M1 Ex ia op is I Ma -20 °C □ Ta □ +50 °C
Air XD USB Drive TX8805.19(.XX...)		I M1 Ex ia I Ma -20 °C □ Ta □ +50 °C

6.2 Conditions of use:

The following Special Conditions of Safe Use and Specific Conditions of Use apply to the above ATEX and IECEx Certificates.

The equipment has the following parameters which shall be observed when connecting in an intrinsically safe circuit:

	Connector P1 Supply to TX8005	Connector P7 Relay contacts – Relay A and Relay B	Connector P5 RS485 - All lines combined	Connector P4 (Ethernet) – All lines combined	Connector P9 4-20 mA – CH2, CH1 - Separate channels
Terminal no.	1 wrt 2	4, 5, 6 and 7, 8, 9	11, 13 or 12, 14 wrt 10 and 15		16, 17 and 18, 19
Ui	16 V	16 V	8.4 V	17.64 V	16 V
Ii	3.28 A				132 mA
Pi					273 mW
Ci	0 μ F	0 μ F	0 μ F	0.48 μ F	Negligible
Li	0 μ H	0 μ H	0 μ H	0 μ H	Negligible
Uo		0 V	5.88 V	0 V dc	15.75 V
Io		0 A	127 mA	0 A dc	510 mA
Po			186 mW	0 W dc	2 W
Co			1000 μ F	1000 μ F	15.8 μ F
Lo			28 mH	97 μ H	1.7 mH
Lo/Ro				145 μ H/ \square	230 μ H/ \square

Refer below for example terminal number identification for external connection:

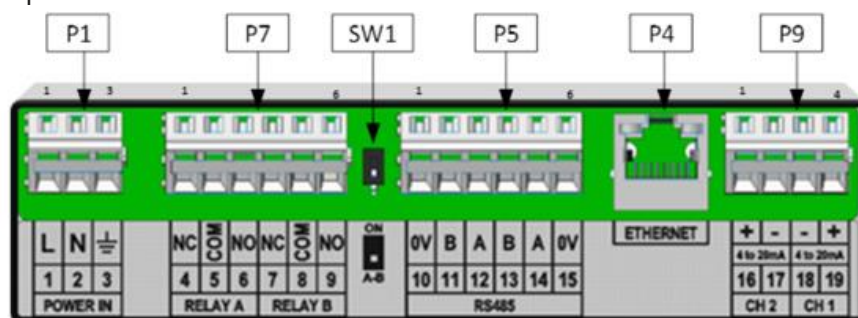

The USB connector on the base of the equipment shall only be connected to the Trolex TX8805 Air XD USB Drive in the hazardous area.

USB drives with no power source (e.g. standard USB stick) may be connected to the USB connector in the safe area for test purposes etc.

The TX8005 must be earthed at pin 3 of the POWER IN connector (P1) to prevent excess static charge accumulation.

7. Technical information

7.1 Product Options

Air XD

Product options:

TX8005		Power Supply		Communications		Particulate Monitoring	
Certification		9 V to 36 V dc	01	Ethernet	01	Full (all PM sizes)	01
IECEX Group I (Aus)	06			RS485	02	TSP Only	02
ATEX/IECEX Group I	19						

7.2 Product Specification

Particulate Sensing Parameters

PM size range	PM1.0, PM2.5, PM4.25, PM10 and TSP
TSP range	Up to 40µm displayed in mg/m ³ or µg/m ³
Extended range	TSP indicative up to 150µm displayed in mg/m ³ or µg/m ³
PM measurement range	0.35 - 40µm over 24 bins
PM measurement capability*	Up to 1500 mg/m ³
PM continuous operating range**	Up to 25 mg/m ³
PM density	0.8 g/ml – 8.0 g/ml (default: 1.65 g/ml)
PM measurement units	mg/m ³ or µg/m ³
Averaging period	1s - 24hrs
Averaging channels	Two configurable (default: 15min and 8hr)
Sampling interval	1s
Particle count	Up to 10,000 (particles/second)
Flow rate	Dynamic (1.2 L/min nominal)
Total flow rate	5.5 L/min (typical)
Accuracy	+/- 5%

*The instrument can define particulate measurement peak trends up to the quantity specified.

**During sustained high dust loading periods, the instrument will report on PM data up to the quantity specified.

Note: Sustained exposure to PM quantities above 25 mg/m³ will be logged, however, may affect the operating life of the particulate sensor (OPC).

Technical Specification

Ambient temperature limits	-10°C to +45°C
Humidity	0-95% RH (non-condensing)
Protection classification	Main Enclosure, Dust and Waterproof: IP66 Particulate Flow Path, Cap Open: IP22 Particulate Flow Path, Cap Closed: IPX6
Housing material	Polymer coated stainless steel
Net weight	8.2 kg
Cable entries	5 x M20 with removable blanks 1 x M20 breather gland (where specified) 1 x M20 USB connector (where specified)
Nominal power supply	12V, 500mA
Minimum supply input	9.8V
Max peak supply current	660mA nominal
Power consumption	6W
Inrush current	350mA Peak
Relay outputs	Two configurable (alarm outputs) Dry contact Maximum rating 16V dc 300mA (internal overcurrent and overvoltage protection fitted)
4-20mA outputs	Two configurable (real-time or average readings) R1 and R2 with adjustable set points Max attached load: 280Ω
Communications	RS485 data output with MODBUS RTU protocol, or Ethernet (MODBUS TCP/IP optional)
Data download	External USB interface
Instrument Data storage	8GB >10 years (logging interval dependent, default 10s)
User interface	128 x 64 dot matrix display with RGB backlight Navigation keypad (membrane)
Visual alarms	Display RGB backlight
Indicators	1 x Green high brightness LED – Sensor heartbeat 1 x Blue high brightness LED – Communications

7.3 Product Dimensions

Note: Recommended 100mm inlet clearance distance

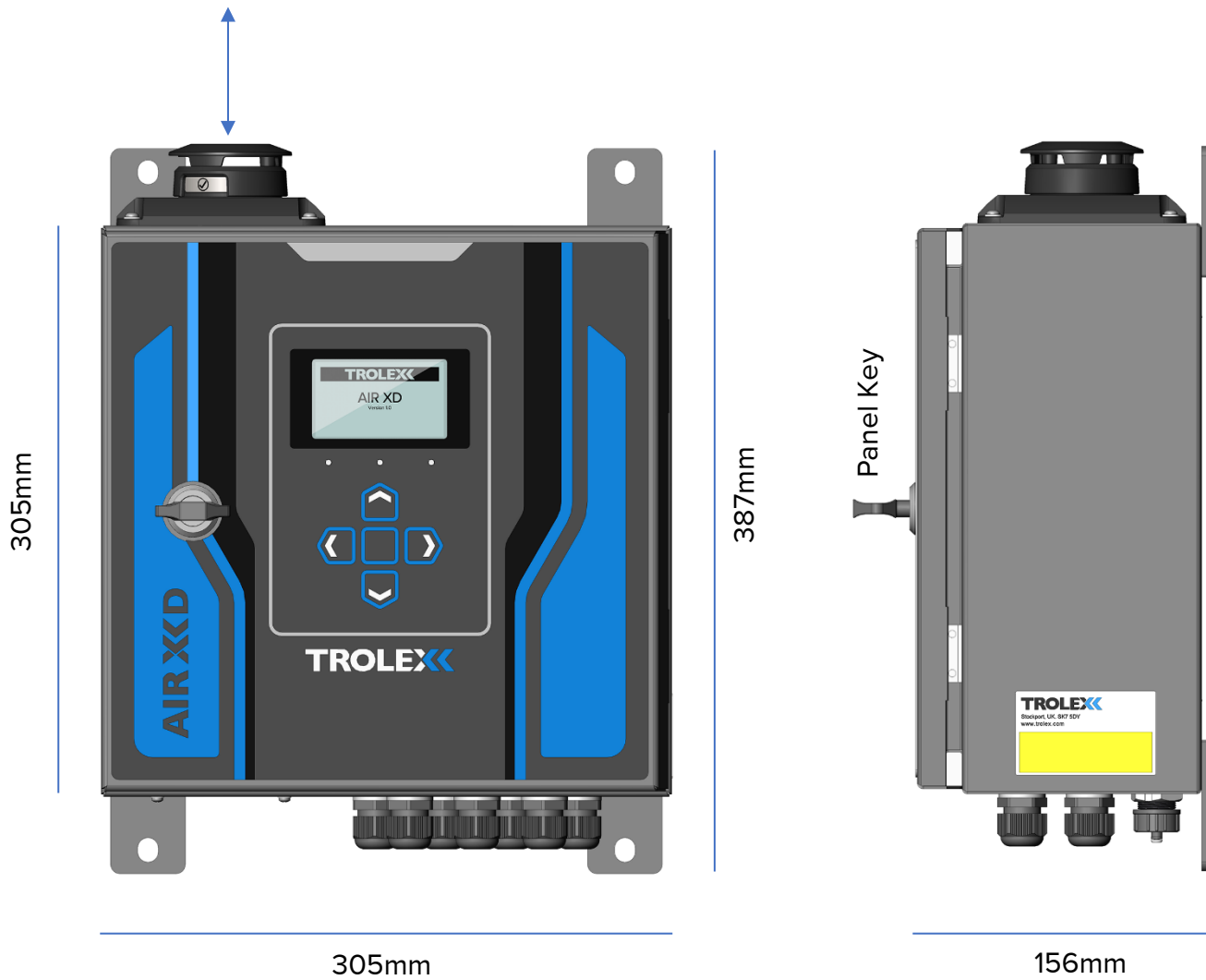

8. Hardware Installation

8.1 Safety Precautions

Refer to Section 4 of this user manual before undertaking the installation of the Air XD instrument. The installation location of the Air XD instrument is the prerogative of the installer and care should be taken to ensure an appropriate position has been selected. Consider the location of a suitable power supply and external fuses, access to a communications network and the protection of cabling from damage.

1. Secure the Air XD to a suitable mounting surface using the integrated mounting brackets.
2. Ensure that the Air XD is mounted in an upright position.
3. Unlock and open the enclosure door to access the internals of the enclosure.
4. Ensure power is isolated before making electrical connections to the instrument.
5. Power supply v must match the instrument IS Entity Parameters (refer to section 6.1.2).
6. Ensure external switches or fuses are installed where applicable
7. Run the required cables through the cable glands provided in the bottom of the enclosure.
8. Wire the cables into the relevant terminals on the internal plate (refer to section 8.4).
9. Tighten the cable gland against the cable to ensure an IP seal.
10. Close and lock the door after use to maintain IP rating of the enclosure.
11. Ensure that the particulate entry and exit ports are not restricted or covered.

Note: When the door is open, the instrument is susceptible to ingress so care must be taken to ensure the location is clean during installation.

8.2 Mounting Details

Note: Ensure the Air XD housing is mounted vertically during installation.

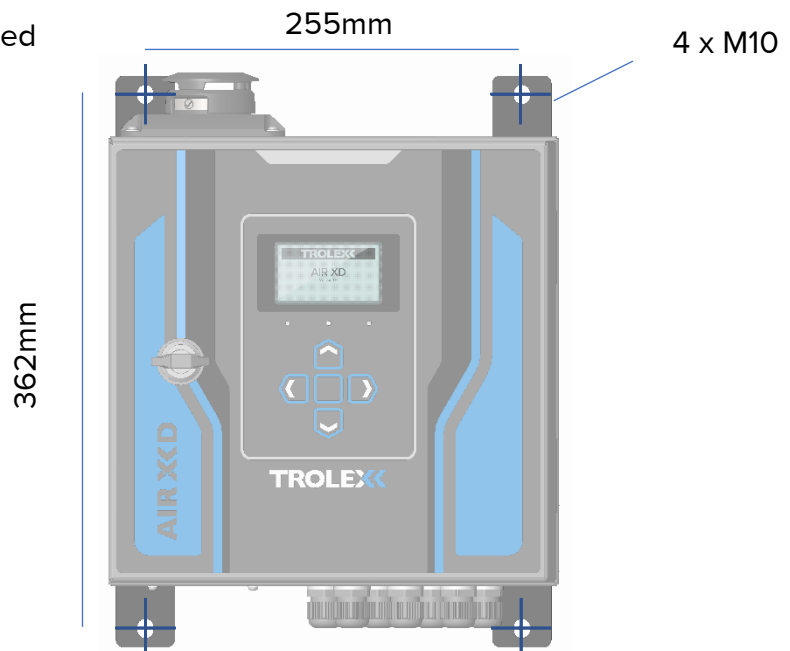

8.3 Main Parts

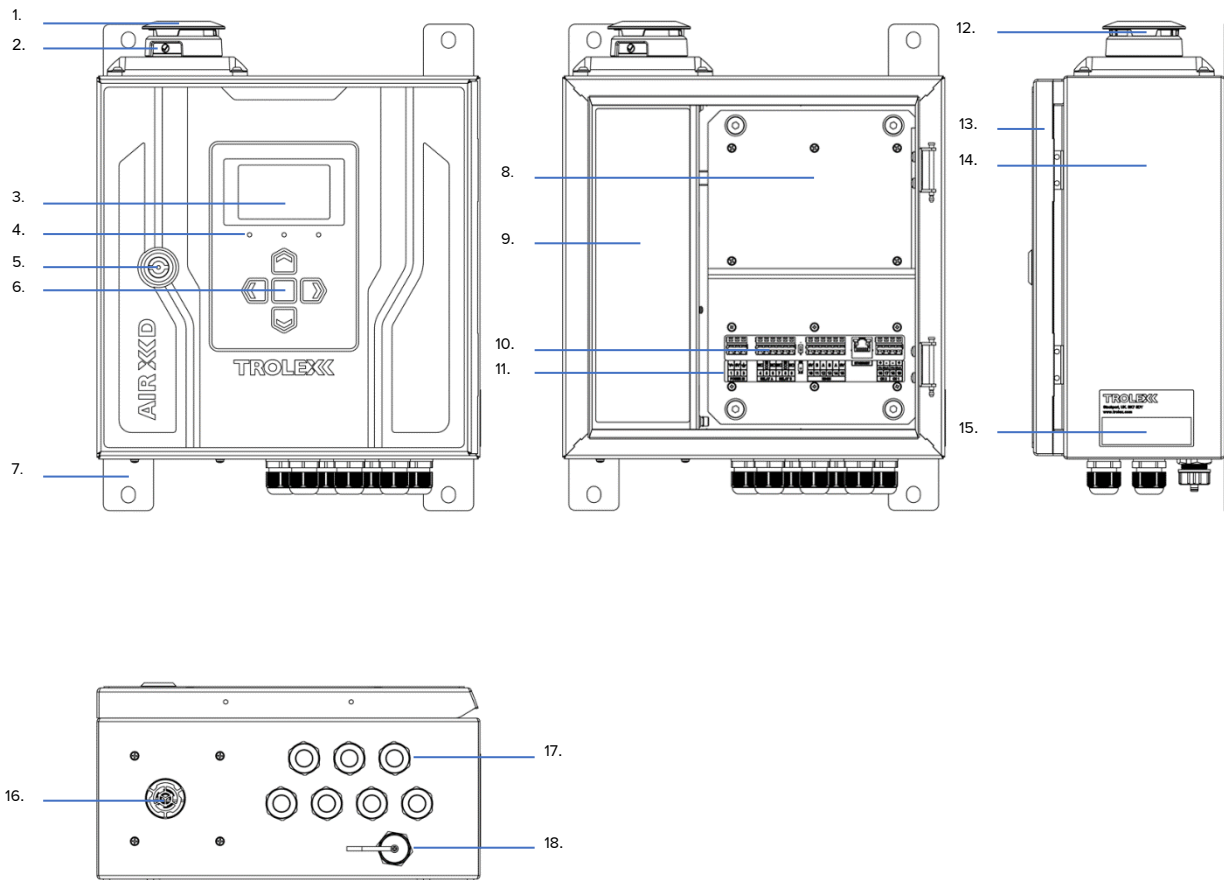

1. Ingress cap	10. Input/Output terminals
2. Inlet flow On/Off label	11. Input/Output labels
3. Display	12. Particulate inlet aperture
4. Status L.E.D's	13. Enclosure door
5. Door lock	14. Main enclosure
6. Navigation keypad	15. Rating Plate
7. Mounting brackets	16. Particulate outlet grille
8. PCB mounting plate	17. M20 cable glands
9. Particulate sensor housing	18. USB interface

8.4 Electrical Connections

The figure and tables below detail the connections available internally in the Air XD instrument. The connections can be accessed by opening the front housing of the instrument using the supplied key. The connections are clearly labelled on the internal metal plate. Wires are inserted into the connector terminals by first using a small flat-head screwdriver or dedicated tool inserted into the small recess above the appropriate terminal. Pushing the screwdriver down into the mechanism opens the connector terminal allowing the wire to be inserted into the opening. Before placing the wire into the connector, ensure that the wire has been stripped back sufficiently and crimp attached, where required, to enable a good electrical connection. Once the wire has been sufficiently pushed into the terminal, remove the screwdriver to allow the mechanism to clamp the bare wire or crimped end. Give a gentle tug on the wire to make sure it has been clamped sufficiently by the connector. Ensure mains cables are fixed in place using the mounting points provided. Details of the connections are given in Tables 1 and 2 below.



V+	0V	\perp
1	2	3

DC Power Input

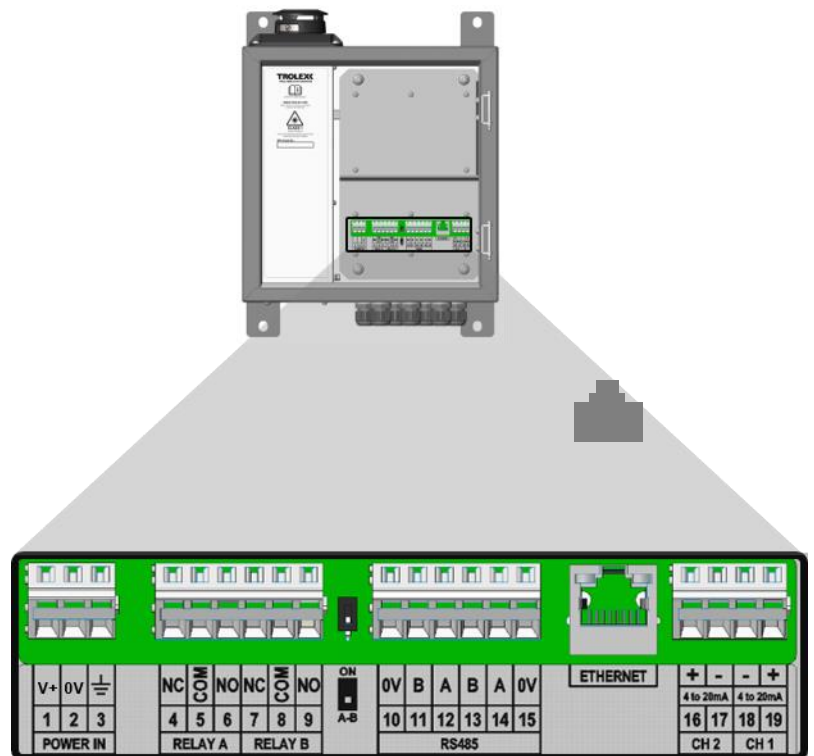

Power In		Relay Connections			RS485 Communication			
1	Supply voltage	4	Relay A: Normally Closed		10	RS485 0V		
2	0V return	5	Relay A: Common		11	RS485 B		
3	Earth	6	Relay A: Normally Open		12	RS485 A		
		7	Relay B: Normally Closed		13	RS485 B		
		8	Relay B: Common		14	RS485 A		
		9	Relay B: Normally Open		15	RS485 0V		

Table 1: Power, Relay and RS485 terminal connections

The pin connections listed in Table 2 for the Ethernet connector are not labelled in the figure but relate to the internal connections of the RJ45 connector with Pin 1 on the left up to Pin 8 on the right. The switches shown either side of the RS485 terminals in the figure allow setting of half duplex or full duplex mode.

Ethernet	4 to 20mA – Ch2 and Ch1	
Pin 1: TX+	16	+ out
Pin 2: TX-	17	0V return
Pin 3: RX+	18	0V return
Pin 4: No connection	19	+ out
Pin 5: No connection		
Pin 6: RX-		
Pin 7: No connection		
Pin 8: No connection		

Table 2: Ethernet and 4 to 20mA connections

8.5 I/O Terminals

Power, RS485, 4-20mA and relay connection terminal data is highlighted below.

Actuation type	Operating tool
Solid/Stranded conductor	0.08 - 2.5mm ² / 28 - 12 AWG
Conductor with Ferrule	0.25 - 1.5mm ²
Strip length	5 - 6mm / 0.2 - 0.24 inch

8.6 Power Connections

For instruments connected to a DC power supply, it is the responsibility of the installer to ensure that the instrument is installed with a DC supply, meeting re-enforced insulation requirements of EN61010-1 or equivalent.

8.7 RS485 – Output Signals

The Air XD provides in and out RS485 terminals to allow daisy chaining of multiple MODBUS devices. For example: Pin 11 is common with Pin 13.

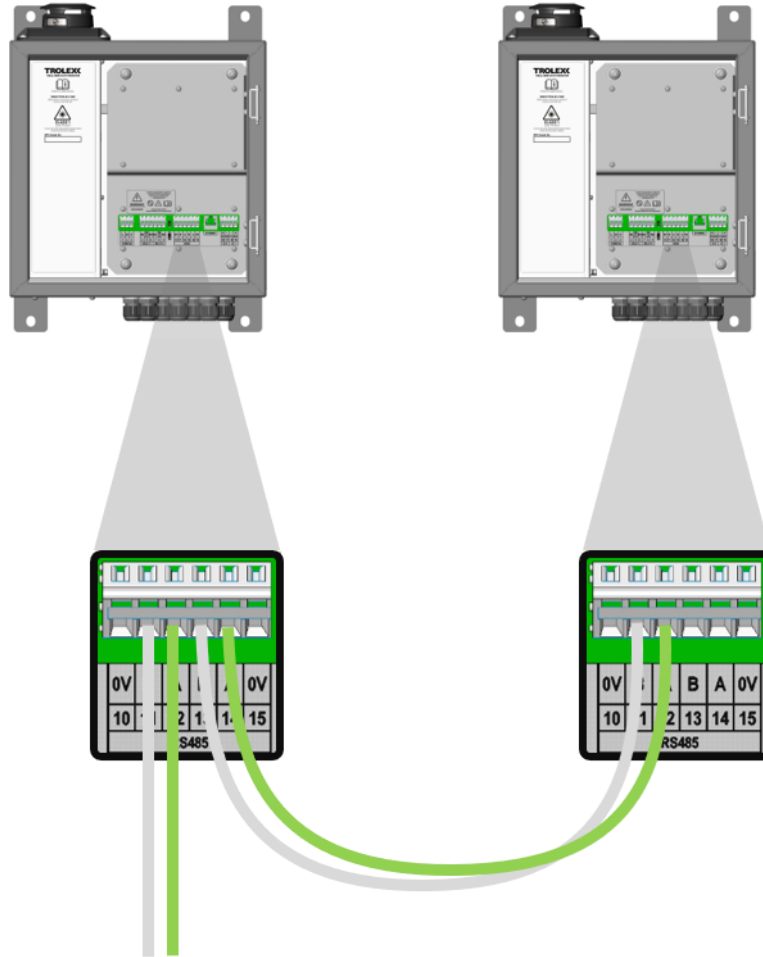

8.8 RS485 – Line Terminations

Some network installations may require a line termination resistor to be connected across RS485 lines A and B. A 120Ω resistor is available with SW4 set to off as standard, highlighted below.

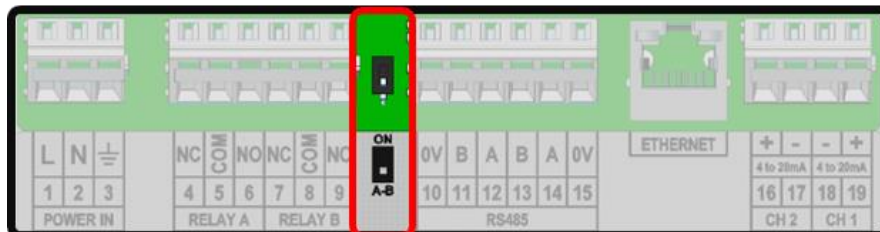

9. Commissioning

Once installed and powered for first time use, the Air XD requires some initial parameter set-up via the on-screen user interface. On connection to the communications network, the instrument will be selectable within the Air XD application software and will begin to push data to the PC application.

9.1 First Power On

Prior to commissioning and first use, the instrument should be inspected for any visible damages and integrity of the enclosure.

1. Ensure that the electrical connections are correctly installed, as describe in section 8.4, and the Air XD is connected to a communications network if required.
2. Ensure that the door is closed and secured.
3. Apply power to the Air XD.
4. A splash screen will be displayed for several seconds whilst the instrument configures.
5. Once configuration is complete, the Air XD will automatically display Live data for all PM sizes.

9.2 Application Software

The Air X application software is available for download and installation from Trolex LTD or via an authorised distribution partner and is specifically designed for the capture of data sets collected by the Air XD instrument. Installation and commissioning of the Air X application software is covered in the separate Air X user manual and installation guide.

Note: The Air X application software is not required for general Air XD operation.

10. Controls and Indicators

10.1 Navigation

The Air XD information software is navigated using the on-device keypad and display. The keypad consists of four directional keys and a central enter key to allow the scrolling, selection and input of data into the instrument.

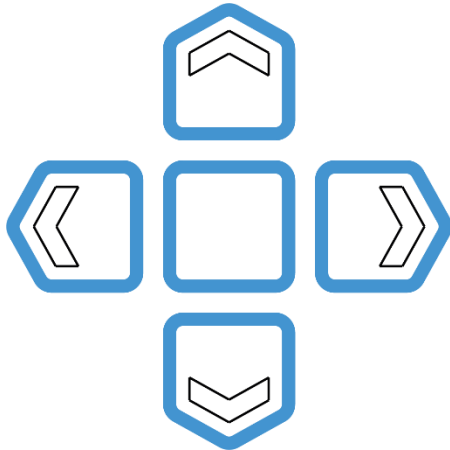

Directional Keypad



User Interface

Throughout the text in this document the navigation keys will be represented as follows:



Up – Up navigation key



Down – Down navigation key



Left – Left navigation key



Right – Right navigation key



Enter – Enter key

10.2 Main Function Keys

Up and Down keys

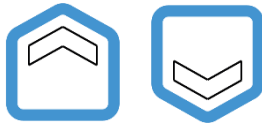

A single press of the Up or Down key is used for the following display functions:

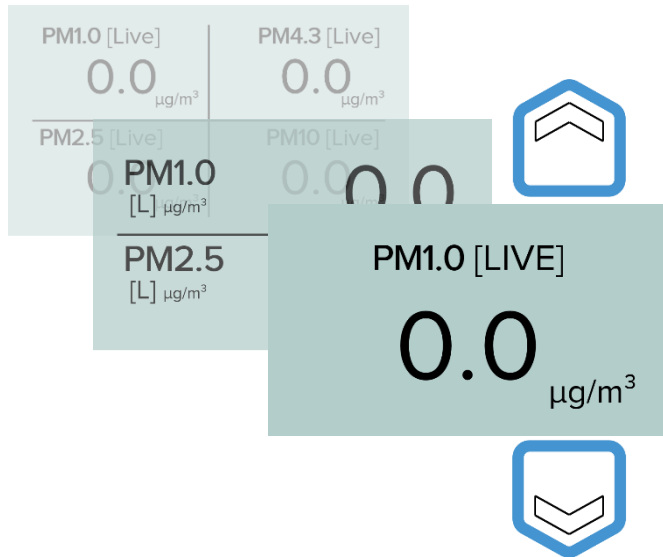

Navigate PM display value screens

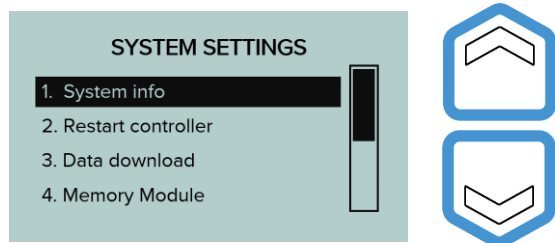

Navigation of vertical menu structures



Increment / Decrement setting values

Left and Right keys



A single press of the functions:

Left or Right key is used for the following display

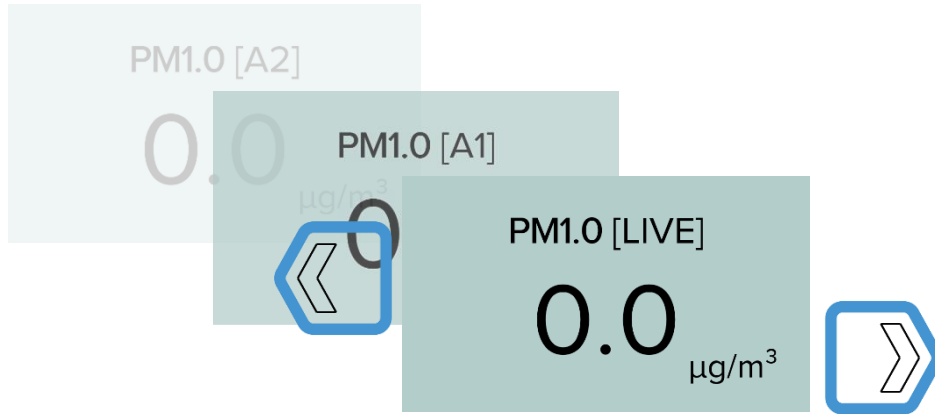

Cycle through Live, Average 1 and 2 screens

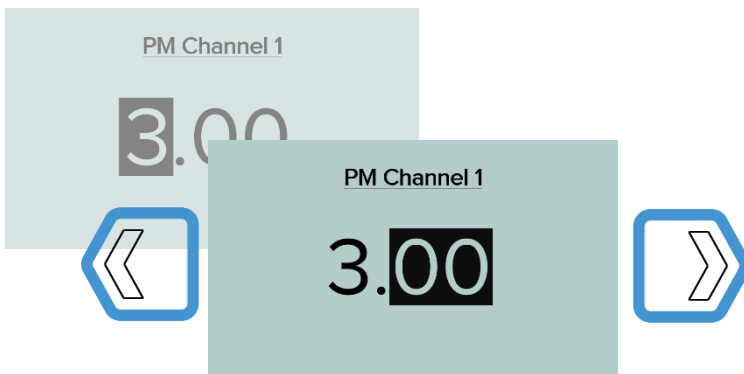

Navigate through entry parameters

Enter Key



A single press of the Enter key is used for the following display functions:

-
- Cycle through PM values on data display screens
 - Select highlighted option whilst in menu structures
 - Confirm input value data entry
-

10.3 Short-cut Functions

Left key



-
- Press and hold to cycle through previous display screen path
 - Release to stop on specific menu screen
-

Up/Down Keys



-
- Press and hold to incrementally skip through numerical values
-

Enter Key



-
- During Live data display, press and hold enter key to enter main menu screen
-

11. General Operation

11.1 User Interface Display

On initial power up of the Air XD, particulate sampling will automatically start, and the graphical display will show the following screens. Once the instrument has been configured, with custom values assigned where required, user inputs will be saved in the instrument memory and on consecutive power cycles the Air XD instrument will always display the following start up screens.

Air XD Power On > Title Card > Live Data Screen (Default to all PM value display)



Title Screen

PM1.0 [Live] 0.0 $\mu\text{g}/\text{m}^3$	PM4.3 [Live] 0.0 $\mu\text{g}/\text{m}^3$
PM2.5 [Live] 0.0 $\mu\text{g}/\text{m}^3$	PM10 [Live] 0.0 $\mu\text{g}/\text{m}^3$

All PM Values [LIVE]
(Default landing screen)

Users can change the particulate sampling display information or enter the instrument settings menu by following the steps outlined in section *11.2 PM value display map* and *11.3 settings structure*.

11.2 PM Value Display Map

The following map details the navigation through the Air XD PM value display screens. Users can select between the number of PM data channels displayed on screen, 1, 2, 4 or all, alongside the required data channel average (Live, Average 1 or Average 2).

Title Screen



All Channel Values
(Default landing screen)



Dual Channel Values

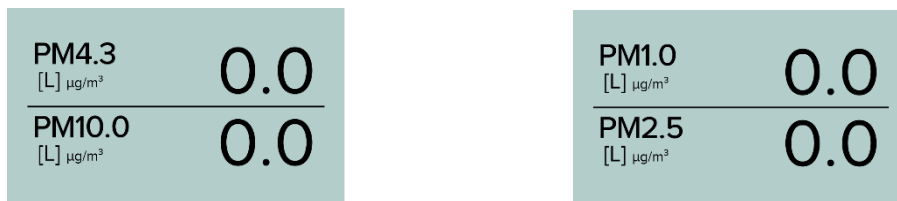

Press ENTER to scroll



Single Channel Values



Press ENTER to scroll



List Channel Values

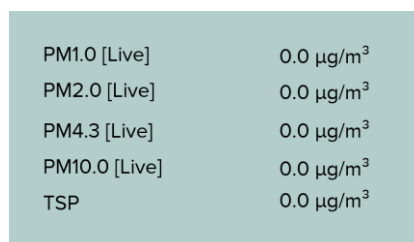

11.3 Settings Structure

The following settings can be configured within the Air XD settings menu by selecting the required field when highlighted within the black selection bar.

Settings Menu

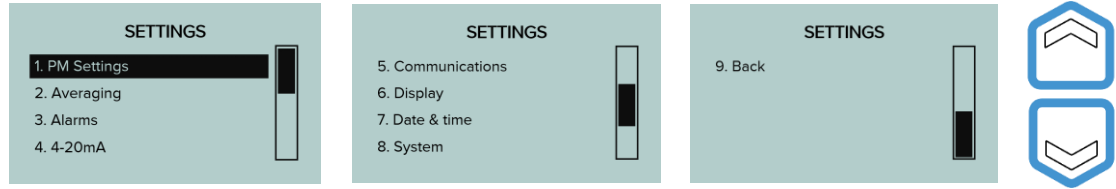

Each settings menu allows users to access the following information or selection options.

- **PM Settings**
Configure and select custom PM values/ranges and map against instrument channels.
- **Averaging**
Configure and select averaging periods for PM Values.
- **Alarms**
Configure and select on-device alarm functionality.
- **Communications**
Configure and select instrument communications protocols.
- **Display**
Configure the on-device display and graphical interface.
- **Date & Time**
Configure the instrument date and time settings.
- **System**
Review, configure and update the instrument system settings.

11.4 PM Settings

Configure and map PM sizes against selected channels (Ch1 to Ch4). PM values can be set to range from 1.00µm to 10.0µm. Users can choose to display either mg/m3 or µg/m3 for all available channels.

Note: The instrument logs data in µg/m3.

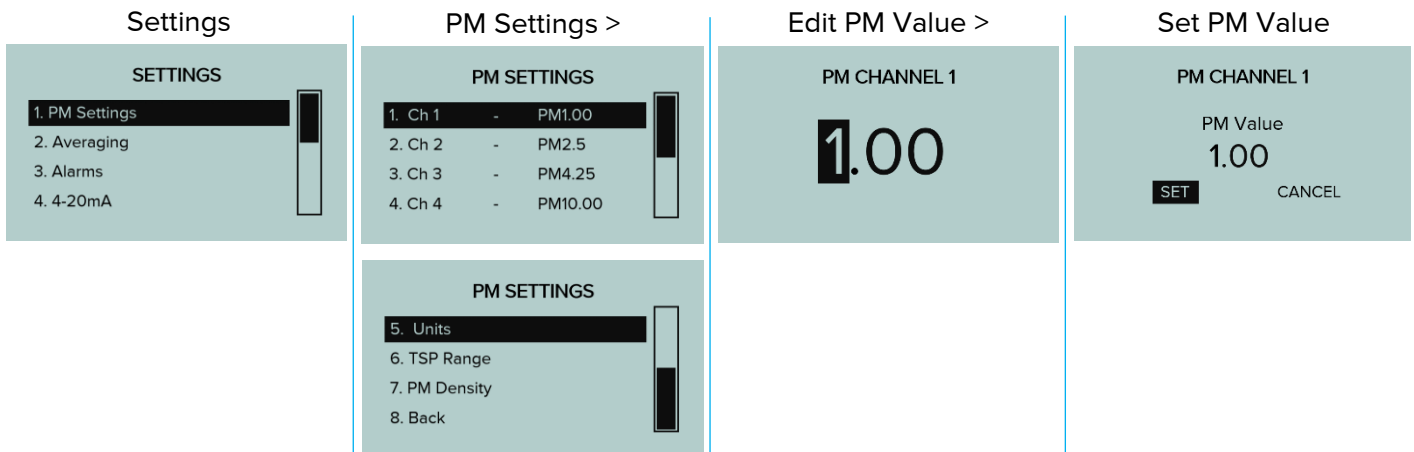

11.5 Setting custom PM values

The following map details the navigation through the Air XD user interface screens to set and configure custom PM values against channels 1 to 4, including TSP.

Settings > PM Settings > *Select Channel for configuration*

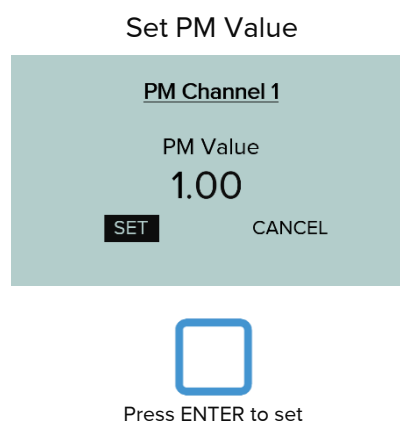
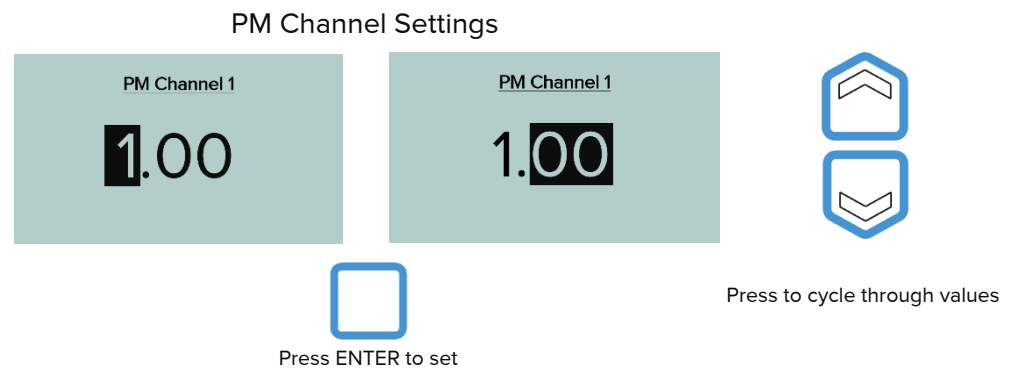

11.6 PM Density

Allows the user to set a custom PM Density value for known particulates in the installation environment. Note: The Air XD uses a PM density value to calculate the mass of known particulates in the installation environment (1.65 g/ml as default).

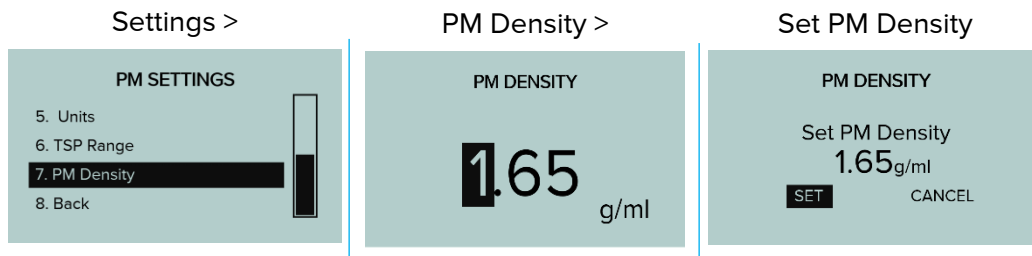

11.7 Averaging Settings

Allows the user to set 2 separate averaging periods or time bases for all PM channels, including TSP. Allowed range from 1min – 24hrs.

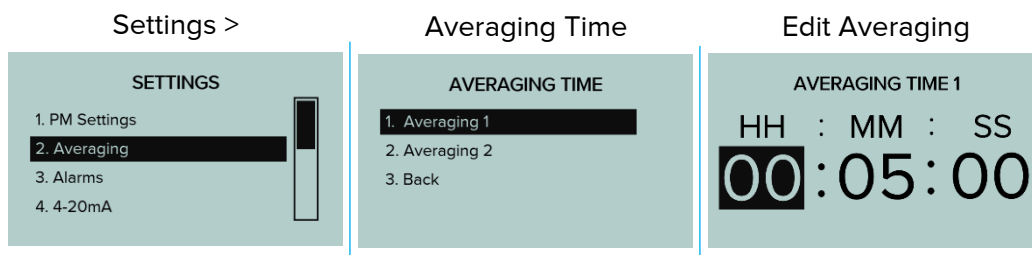

11.8 Alarm Settings

The Air XD offers two, user configurable alarms. Each alarm requires four parameters to be selected and configured to determine the alarm functionality. All alarms are logged in the Air XD event log.

- Assigned a PM Size/Channel (PM1.0, PM2.5, PM4.25, PM10.0 and TSP)

Select one of the four configured PM sizes or TSP as the alarm source.

- Assigned a Data Source/Channel (Live, Average 1 and Average 2)

Select whether to act on live data readings or one of the pre-configured averages (15min or 8hr).

- Assigned a Threshold ($\mu\text{g}/\text{m}^3$ and mg/m^3)

Set the value at which the alarm will trigger ($1 \mu\text{g}/\text{m}^3$ to $9999 \mu\text{g}/\text{m}^3$ or $0.1 \text{mg}/\text{m}^3$ to $6553.5 \text{mg}/\text{m}^3$).

- Assigned Latching of Non-Latching behavior

Choose whether the alarm stays active once the fault condition is cleared or is self-clearing (non-latching). For non-latching selections, alarms will be cleared but the event will be logged.

Note: Once the alarm is triggered, the corresponding relay will then switch, and an alarm message is displayed on screen.



11.9 Channel Select

The Air XD has two alarm channels that can be assigned one of four particulate sizes or TSP (total suspended particulate). Note: The current applied value is highlighted by the 'selection tick'.

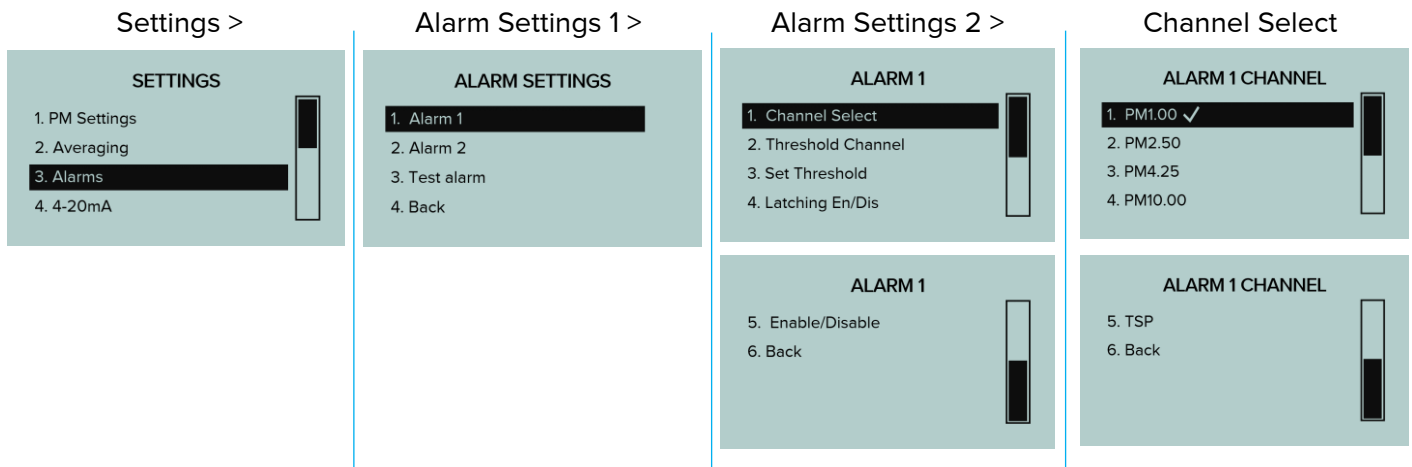

11.10 Threshold Channel

Select and assign an alarm to a specified data source. Note: The current applied value is highlighted by the 'selection tick'.

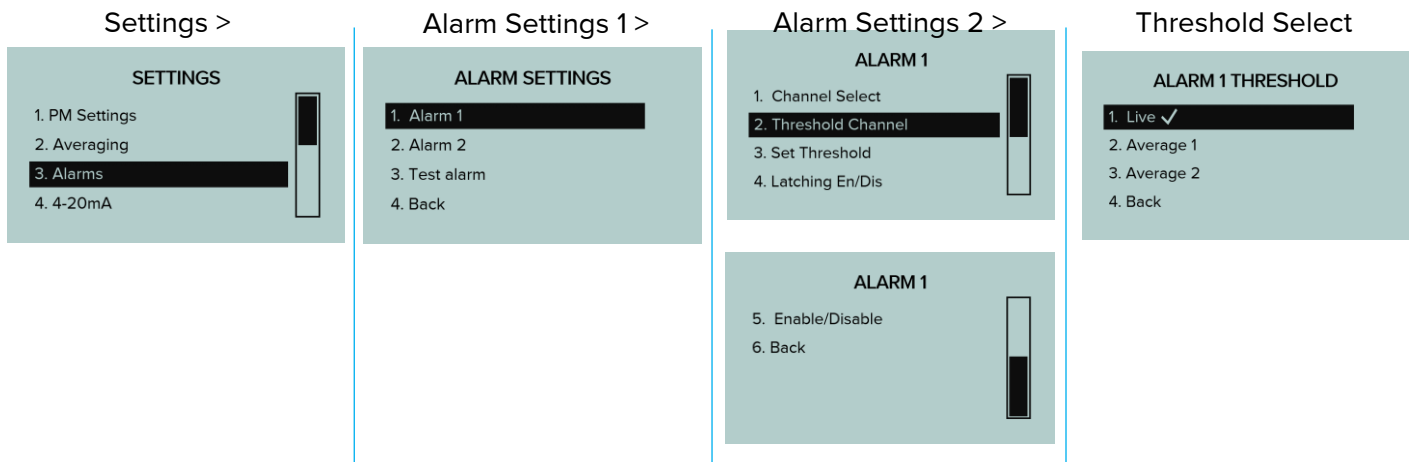

11.11 Set Alarm Threshold

Set the threshold value for when the alarm is activated. Threshold values can be configured between $1\mu\text{g}/\text{m}^3$ to $9999\mu\text{g}/\text{m}^3$ or $0.1\text{mg}/\text{m}^3$ to $6553.5\text{mg}/\text{m}^3$.

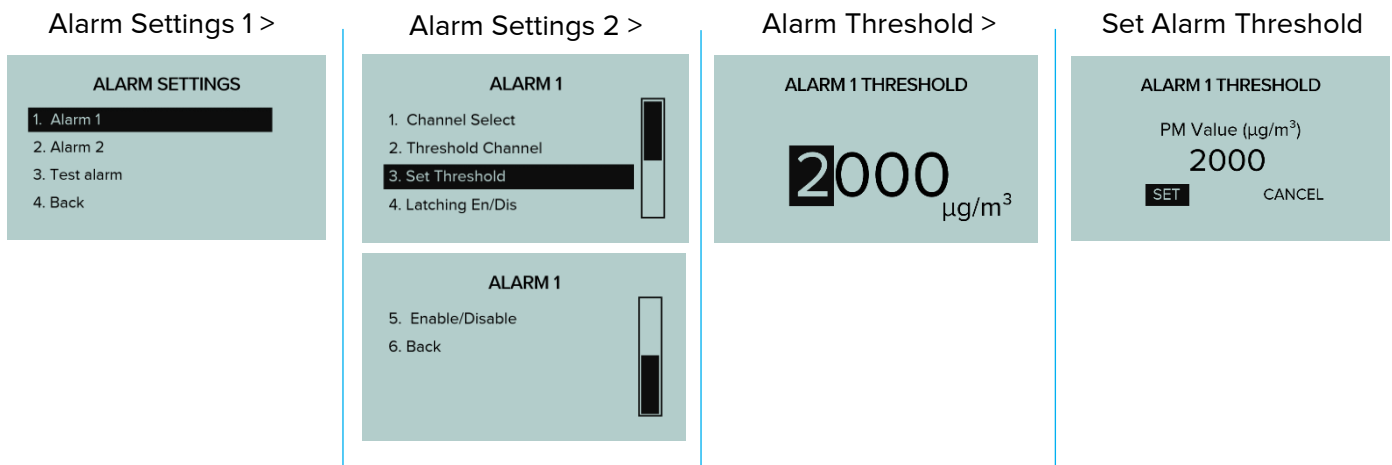

11.12 Alarm Latching

Configure the latching behaviour for selected alarm. Note: The current applied value is highlighted by the 'selection tick'.

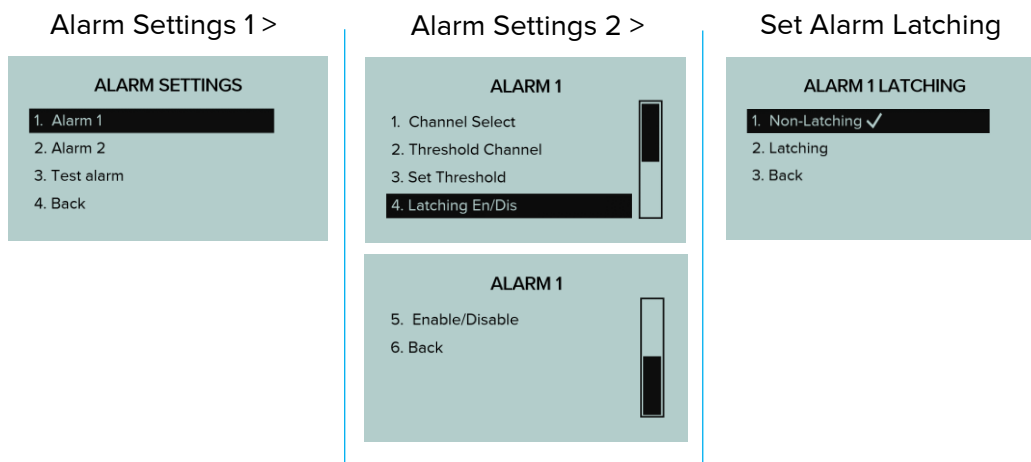

11.13 Alarm Enable/Disable

Enable or Disable audio visual alarms for selected alarm. Note: The current applied value is highlighted by the 'selection tick'.

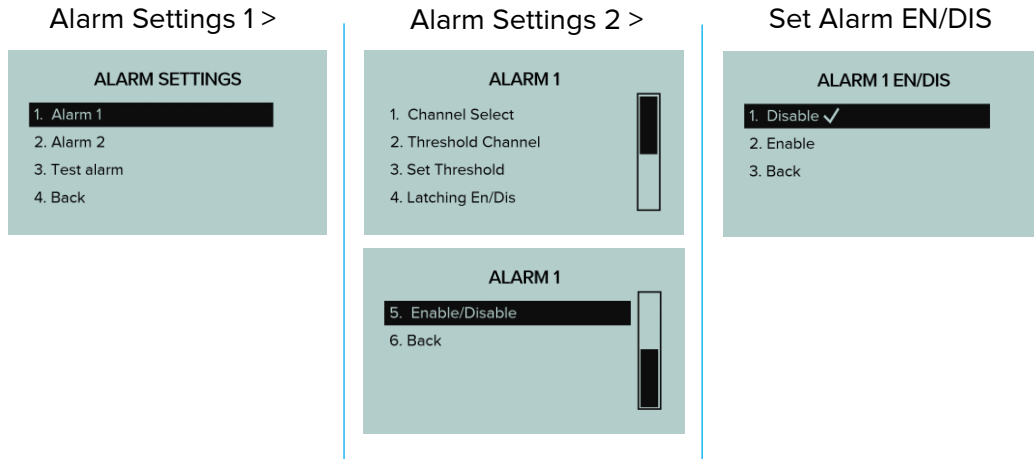

11.14 4-20mA Outputs

The Air XD offers two 4-20mA outputs. Each 4-20mA output requires two parameters to be selected and configured to determine the functionality of each analogue output.

- Assigned a PM Size/Channel (PM1.0, PM2.5, PM4.25, PM10.0 and TSP)
Select one of the four configured PM sizes or TSP as the alarm source.
- Assigned a data channel (Live, Average 1 or Average 2)
Select one of the three data sets to assign the selected 4-20mA output to.

- Assigned the full-scale range of the channel

For example: a full-scale range of 2000 $\mu\text{g}/\text{m}^3$ will output 20mA for a value greater or equal to 2000 $\mu\text{g}/\text{m}^3$ and for a value of 0 $\mu\text{g}/\text{m}^3$ the channel will always output 4mA.

A full-scale range of 6553.5 mg/m^3 will output 20mA for a value greater or equal to 6553.5 mg/m^3 and for a value of 0 mg/m^3 the channel will always output 4mA.

- Enable/Disable the channel

A disabled channel with output 0mA.

During instrument start up and initialisation, each 4-20mA output will perform a calibration routine which involves sweeping the output from 0-20mA before returning to 4mA. After this has been completed, the output will return to configured functionality.

11.15 Select PM Channel

The Air XD has two 4-20mA outputs that can be assigned one of four particulate sizes or TSP (Total Suspended Particulate). Note: The current applied value is highlighted by the 'selection tick'.

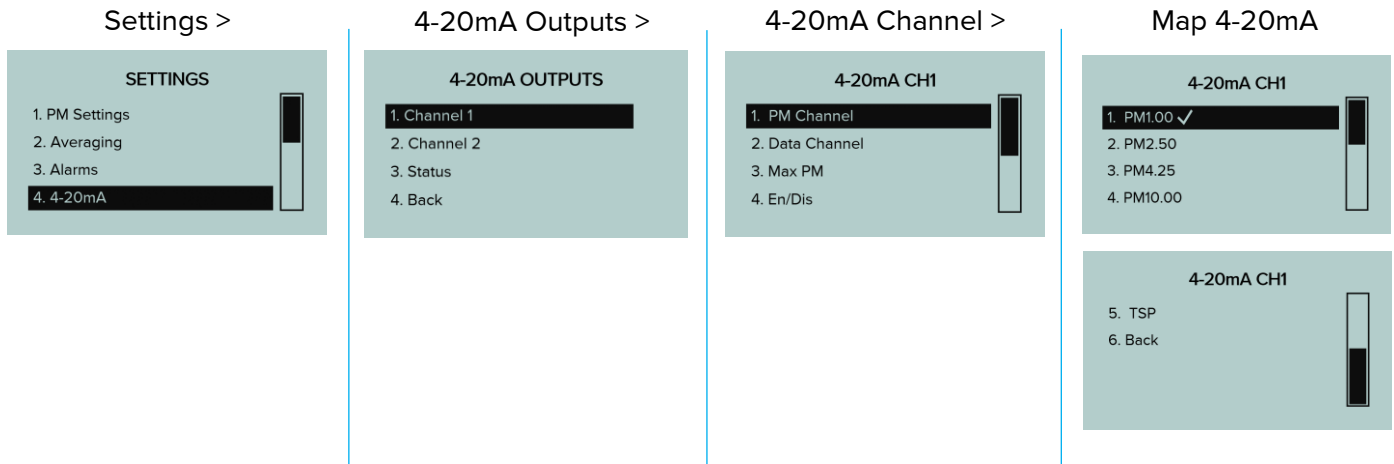

11.16 Map 4-20mA to Data Channel

Map the selected 4-20mA output to the required data channel (Live, Average 1 or Average 2).

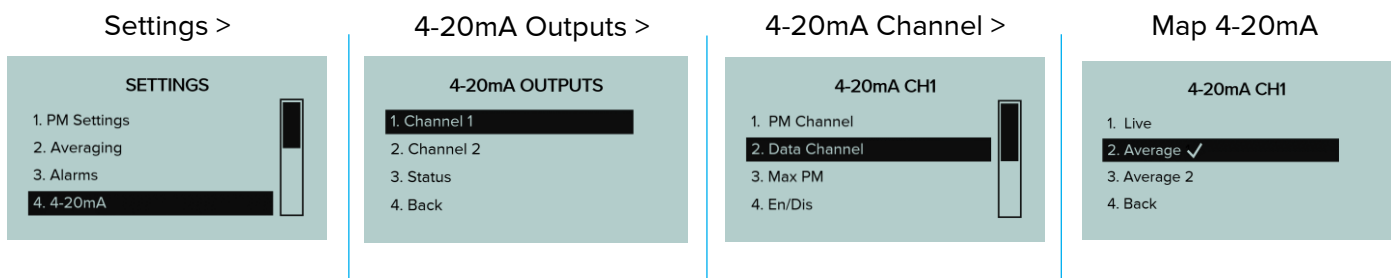

11.17 Set Max PM Value

Set the 4-20mA scaling range for each 4-20mA output. (0-9999 $\mu\text{g}/\text{m}^3$ or 0.1 mg/m^3 to 6553.5 mg/m^3).

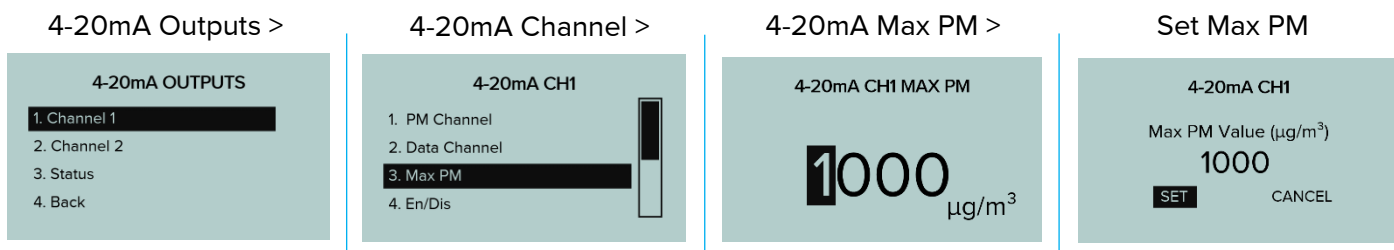

11.18 Enable/Disable

Enable or Disable 4-20mA outputs. Note: The current applied value is highlighted by the 'selection tick'.

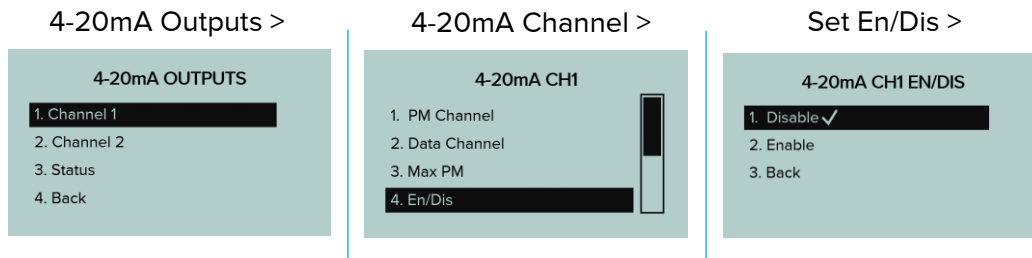

11.19 Status

Check the overview status of the 4-20mA channels.

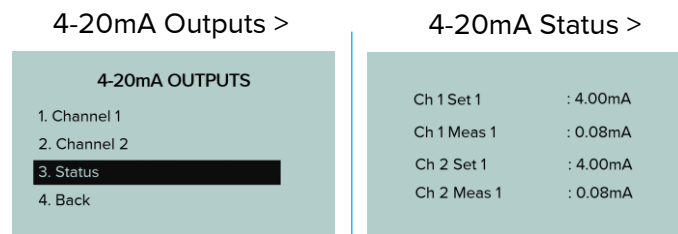

11.20 Communications

The Air XD offers two selectable communications protocols, RS485 MODBUS and Ethernet MODBUS TCP/IP, that can be used to configure and network the instrument. Each communication protocol requires the network and connection parameters to be correctly configured on the instrument and network where applicable.

11.21 Ethernet Communications

The Air XD supports communications over Ethernet MODBUS TCP/IP and can be configured per the system menus below. Ethernet communications require the following parameters to be selected and configured to establish the successful communication with the designated server. Ethernet communication requires a DNS Server as standard and if selecting 'dynamic' (DHCP) IP address, will require a DHCP Server. Firewall settings must allow outgoing traffic on selected port numbers.

Note: The MODBUS TCP/IP communicates over 'Port 502'.

11.22 Network Status

Check the overview status of the connected network.

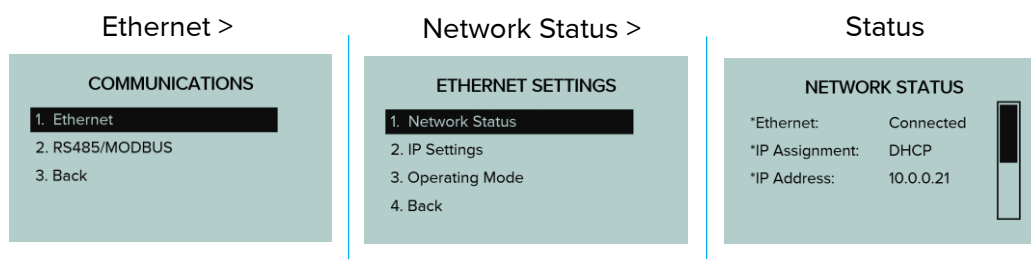

11.23 IP Settings

The Air XD IP settings can be configured based on application requirements. From the IP settings menu users can select and configure the following.

Settings > Communications > Ethernet

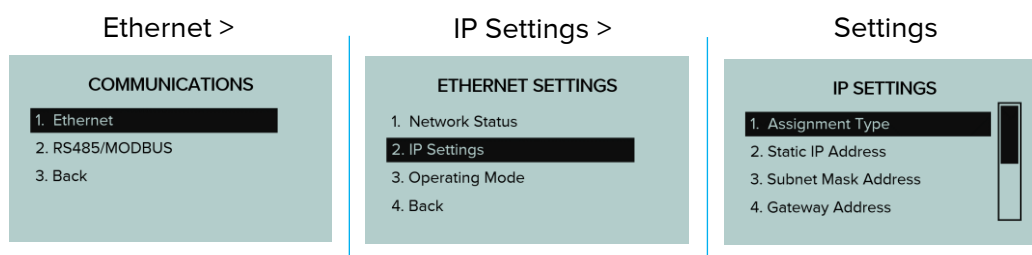

- **Assignment Type**
Select a 'static' or 'dynamic' (DHCP) IP address.
- **Static IP Address**
Enter and set static IP address.
- **Subnet Mask Address**
Enter and set subnet mask address.
- **Gateway Address**
Enter and set gateway address.
- **Primary DNS**
Enter and set primary DNS address.
- **Secondary DNS**
Enter and set secondary DNS address.

11.24 Ethernet Operating Mode

The Air XD can be configured to communicate via MODBUS TCP direct to a laptop or server running a MODBUS client.

Note: Selection of the 'Trolex|Core' option allows the data recorded by the Air XD instrument to be pushed direct to an installed and running Trolex|Core API server. (Not yet implemented).

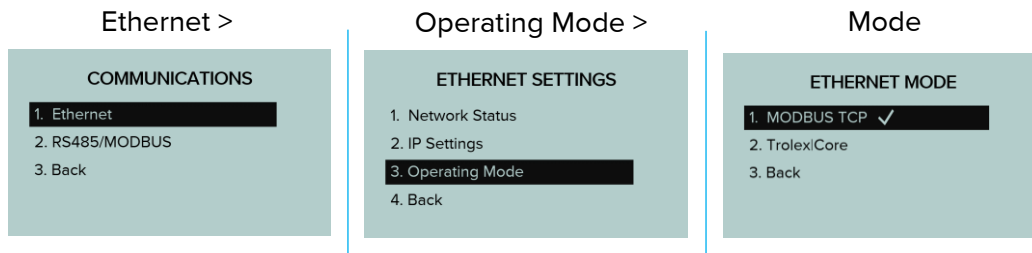

11.25 Ethernet Connection Status

The connection status of the Air XD can be viewed by pressing the 'Left' arrow key from the PM value readings screen. The status screen lists the connection type, connection status and instrument IP Address.

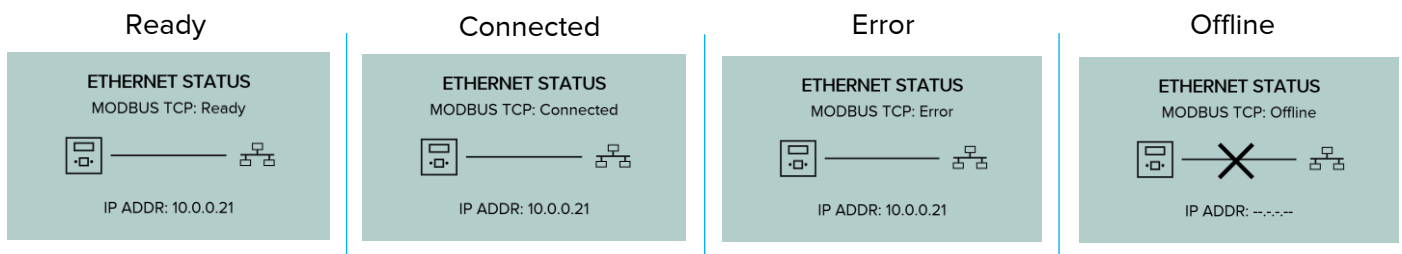

11.26 RS485 MODBUS Communications

The Air XD has configurable MODBUS baud rates and a user configurable address. It is possible to configure the MODBUS device address and baud rate through the on-device display menu.

Settings > Communications > RS485/MODBUS

11.27 Set Baud Rate

The Air XD instrument baud rate can be selected and assigned from a pre-configured list of options.

Note: The current applied value is highlighted by the 'selection tick'.

- 4800
- 9600
- 14400
- 19200
- 38400
- 57600
- 115200 (Default)

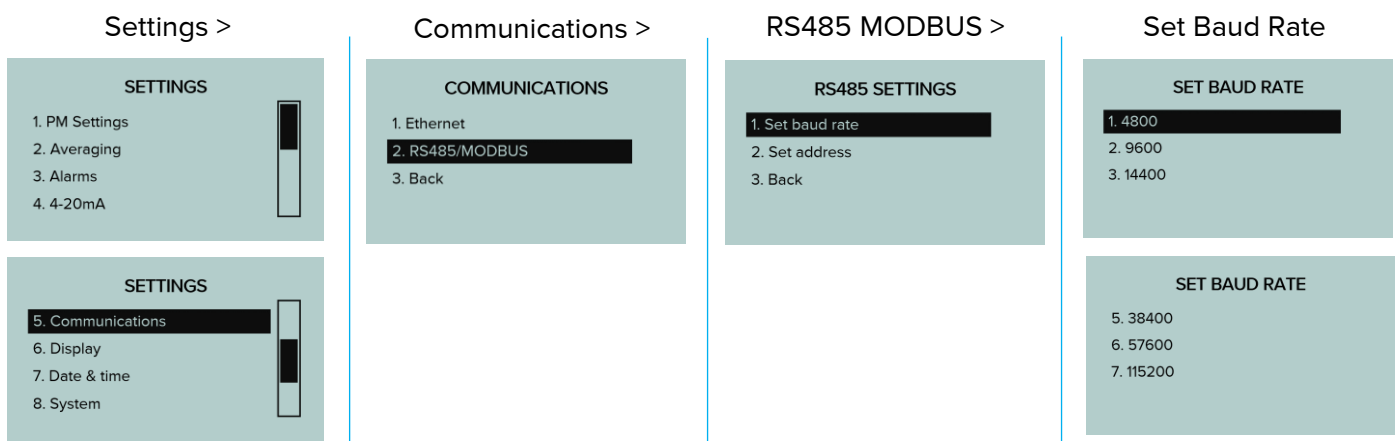

11.28 Set Device Address

The Air XD instrument address is user selectable and can be configured between 001-255.

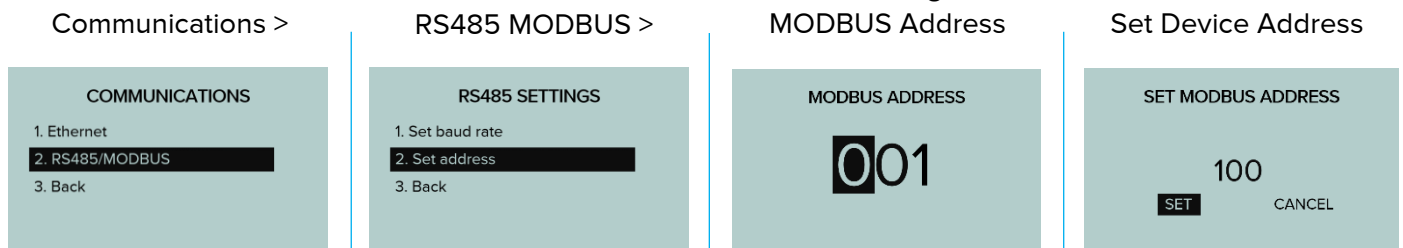

11.29 Display

The Air XD has a 128 x 64 dot matrix display with backlight. Users can select and configure display contrast, backlight colour and brightness. It is also possible to set power saving mode with display sleep functionality.

11.30 Adjusting Display Contrast

The Air XD display can be adjusted to align the contrast ratios with the installation environment.

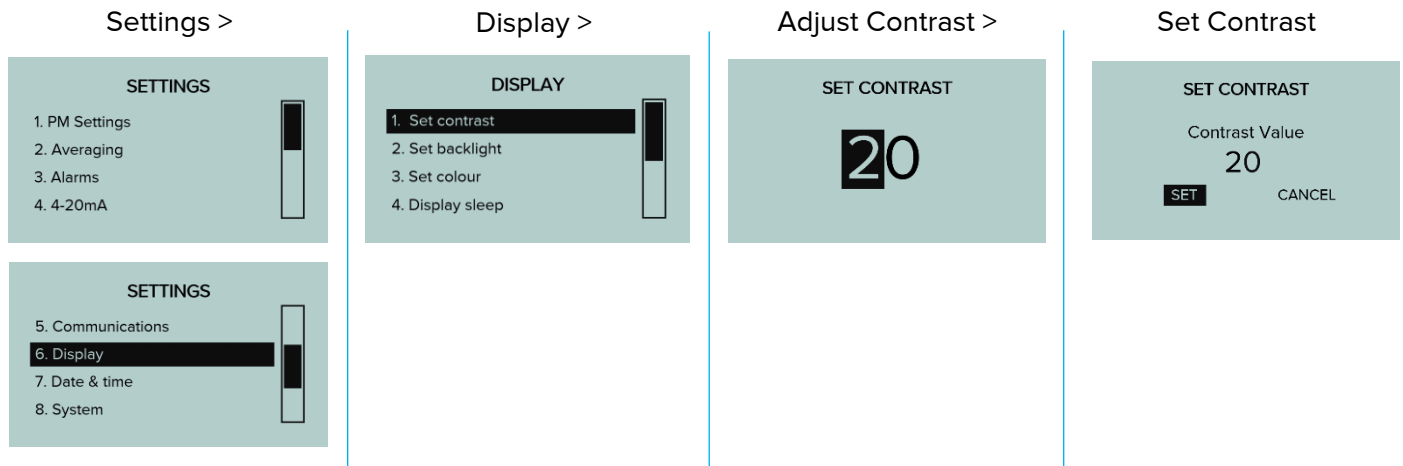

11.31 Set Display Backlight

The Air XD display can be adjusted to align the backlight brightness with the installation environment.

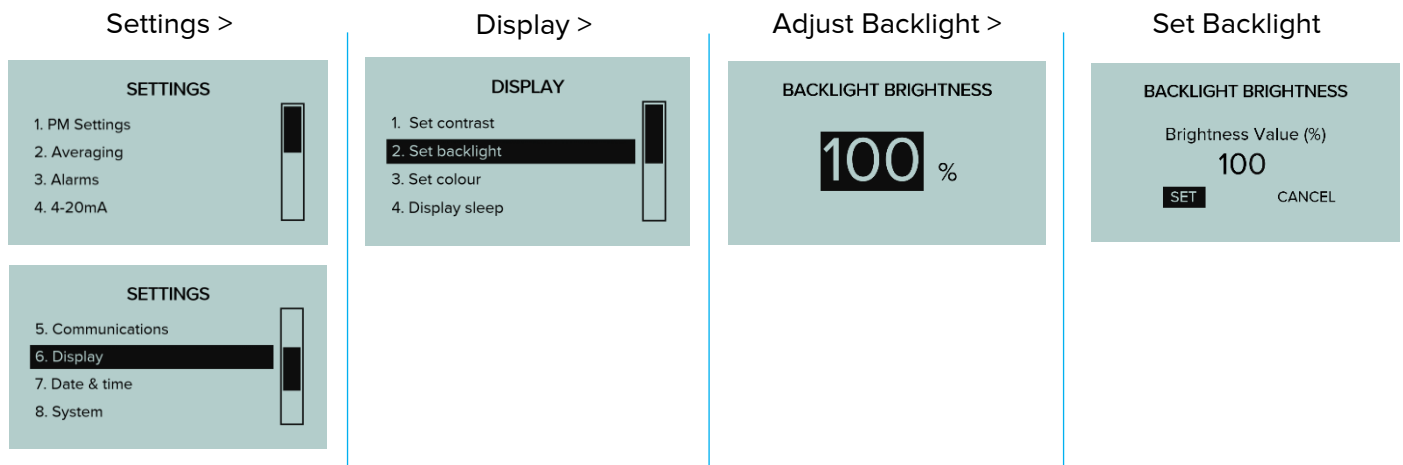

11.32 Set Display Colour

The Air XD display can be adjusted to configure the on-screen colour profile.

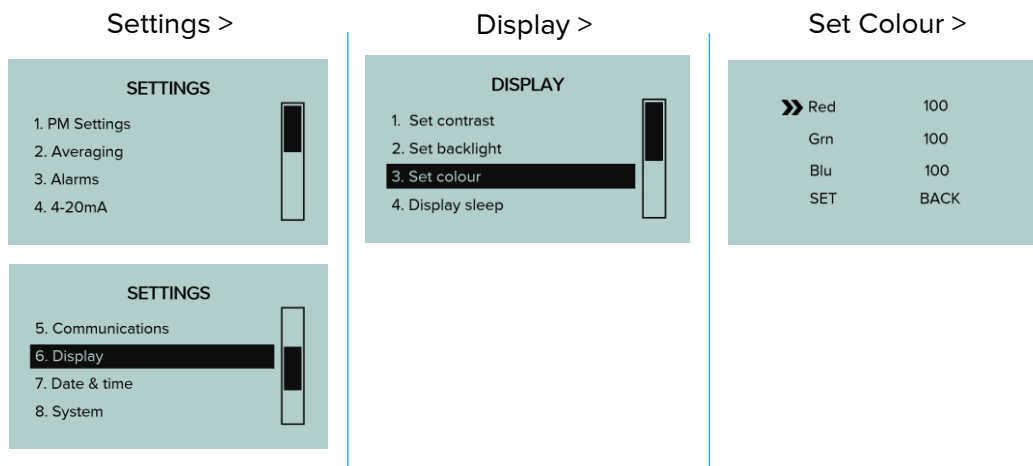

11.33 Set Display Sleep

The Air XD display can be set to enter sleep mode to allow for power saving where required.

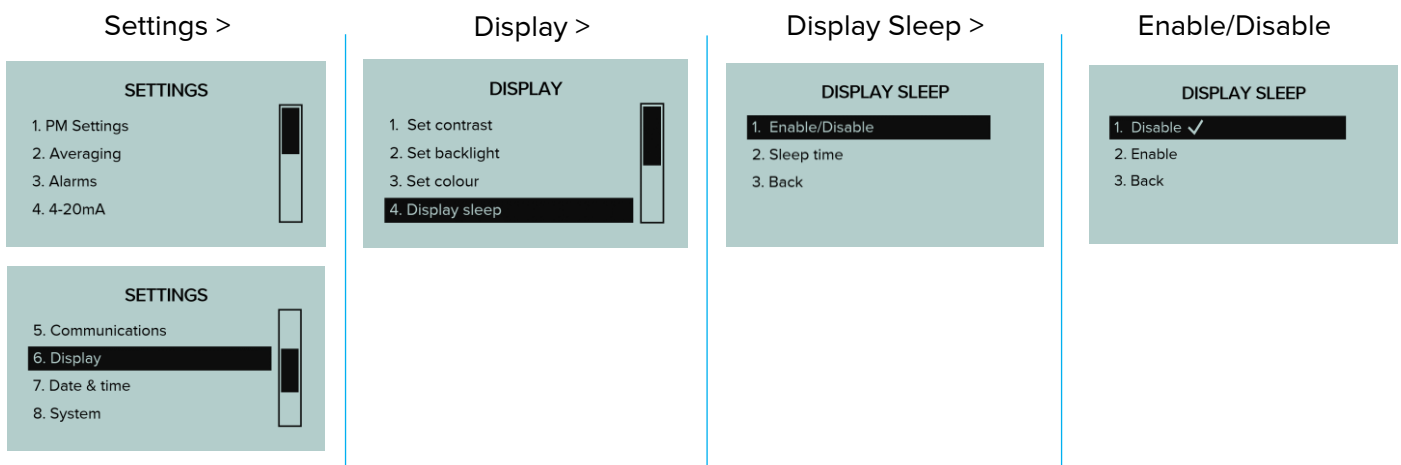

The Air XD display can also be configured to sleep after a chosen time period.



11.34 Date & Time

The Air XD date and time stamp can be configured to suit the installation location.

11.35 Set Date

Configure and edit the date stamp logged by the Air XD instrument. (Format: DD/MM/YYYY)

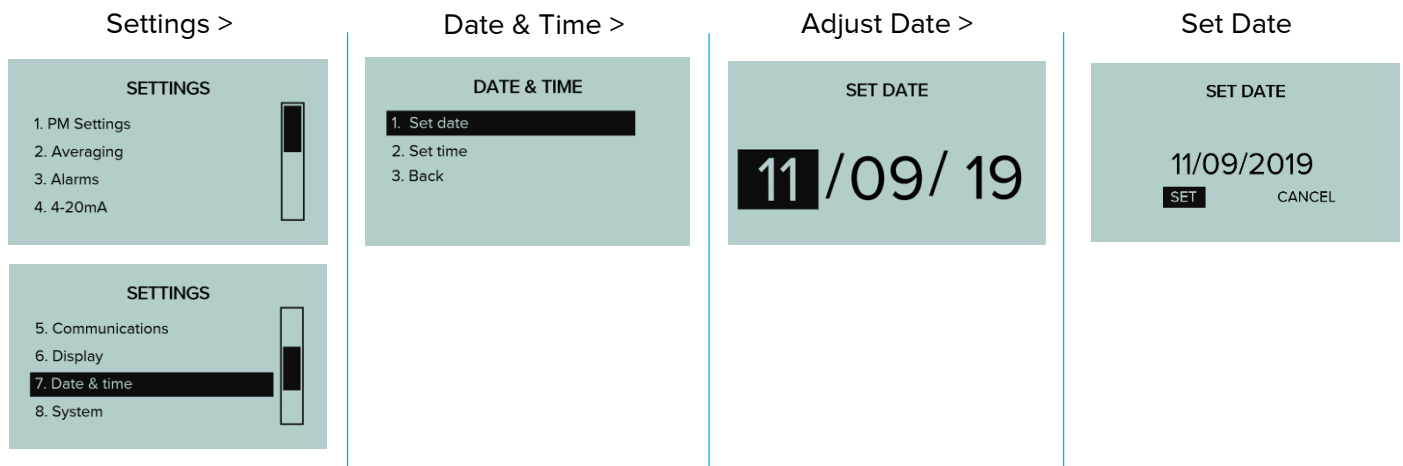

11.36 Set Time

Configure and edit the time stamp logged by the Air XD instrument.

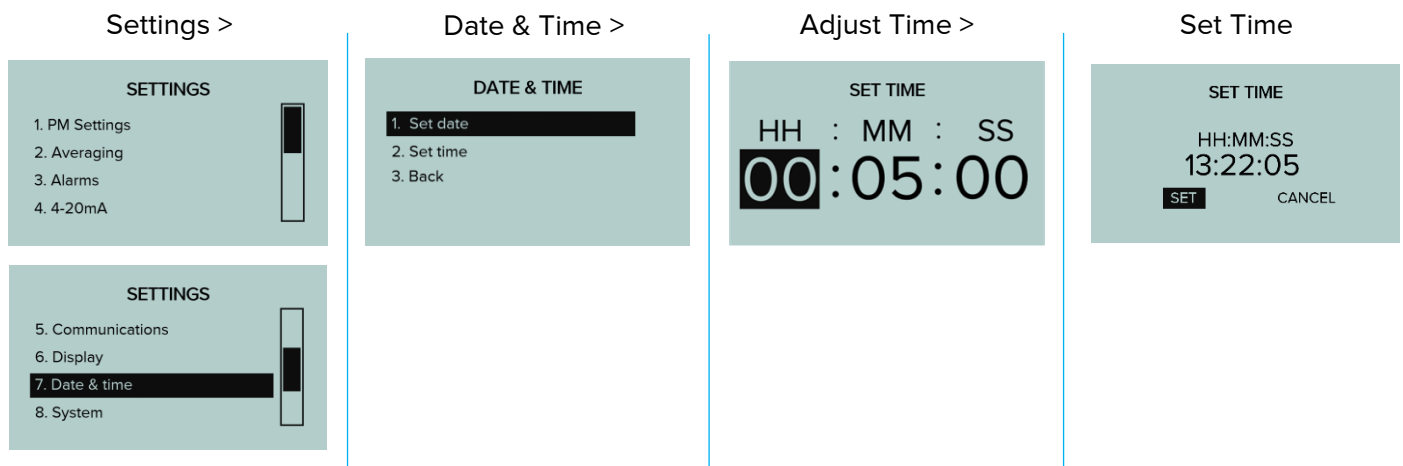

11.37 System

The Air XD system menu allows users to access system performance, serial information, update firmware and restart the instrument.

11.38 System Information

The system information menu allows users to view the functional status of the Air XD instrument.

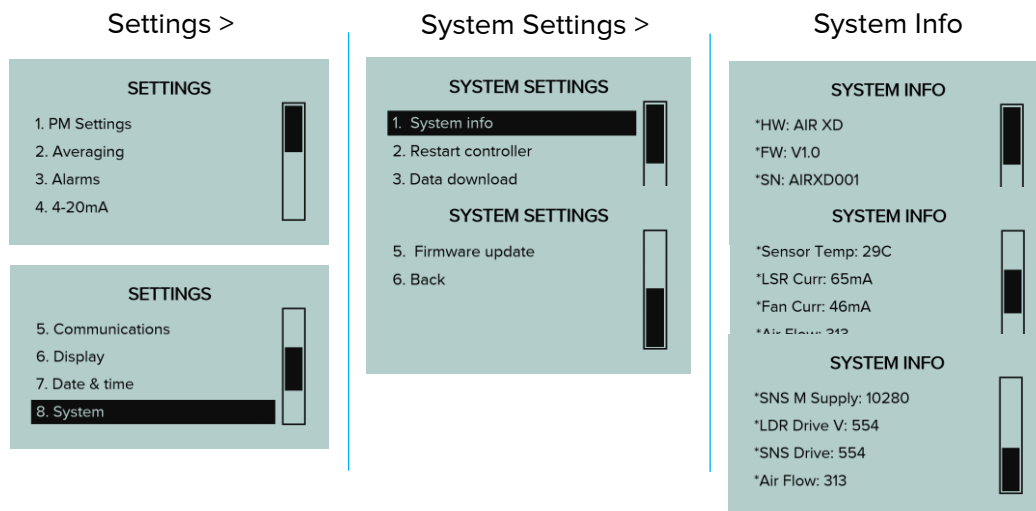

11.39 Restart Controller

The Air XD instrument can be forced to restart and reboot through the 'Restart Controller' menu.

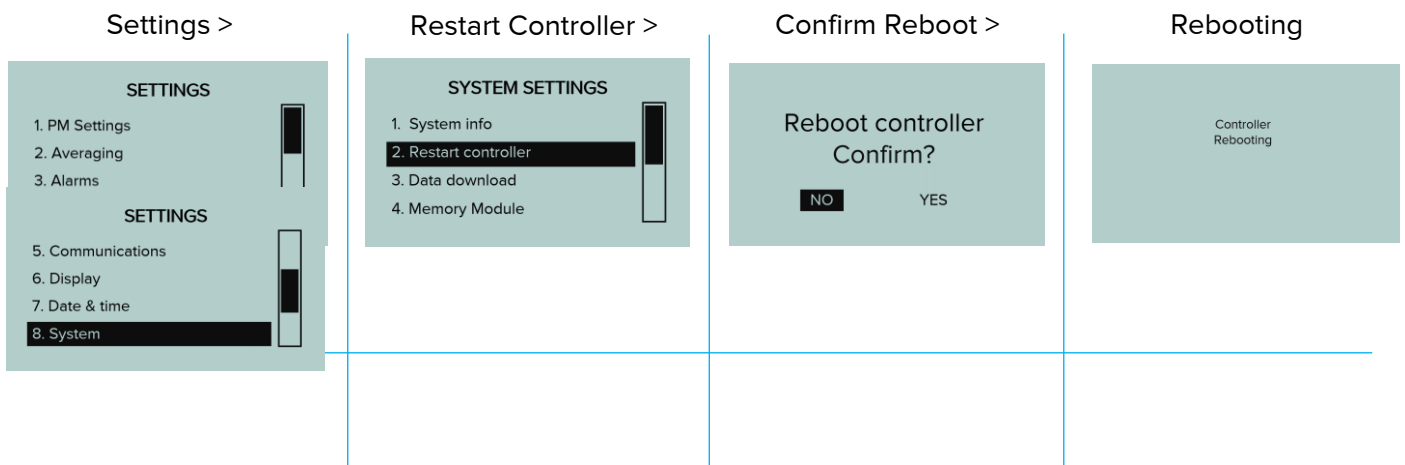

11.40 Data Download

The Air XD allows users to download collected data sets via the 'data download' menu. Data is stored on the instrument internal memory and can be locally downloaded onto a removable Air XD USB drive when connected via the external USB connector positioned on the bottom face of the instrument.

- Collected data can be retrieved from the Air XD instrument in two methods by either selecting the 'Download All' or 'Download New' data sets.
- Selecting the 'Download All' tab will proceed to notify users of the number and total size of the files to be downloaded.

Selecting the 'Download New' tab will proceed to notify users of the number and total size of the files to be downloaded. Note: This function works based on reading the last file name downloaded to the connected Air XD USB drive and only downloading the data set recorded after the last download.

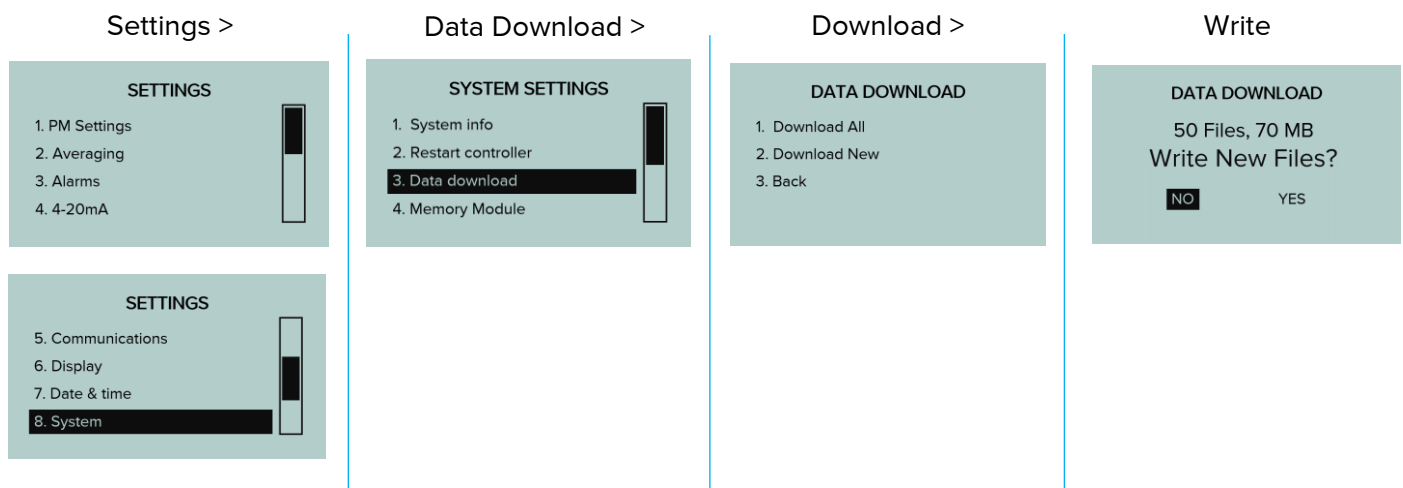

Data download functionality is only available when a removable Air XD USB drive is connected to the Air XD. The following screen will be displayed if a USB device is not connected or cannot be identified by the instrument.

Note: The Instrument USB port operates at 4V, do not connect any other USB device to the Air XD when located in a hazardous environment. USB drives with no power source (e.g. standard USB stick) may be connected to the USB connector in the safe area for test purposes etc. Not all USB drives will operate or be compatible with the Air XD instrument due to operational voltage differences.

Settings > Data Download > Download > No USB Device Connected

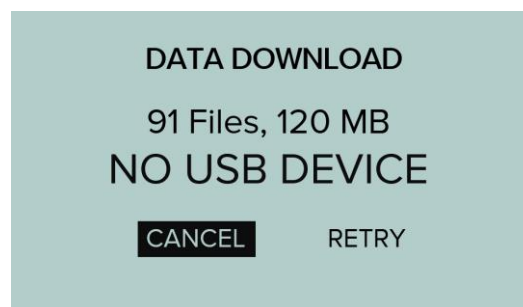

11.41 Memory Module

The Air XD contains an internal Memory Module that is used to locally store collected data sets on the instrument. The module can be configured from the settings menu to allow local data collection to take place or to stop the Air XD from writing to the internal memory.

For the majority of applications, the internal Memory Module will be used and configured to allow the Air XD instrument to locally store data as well as push data to the Air X software via selected communications channels.

For applications that may require power saving functionality, the internal memory module can be de-selected. Note: The current selection is highlighted by the 'selection tick'.

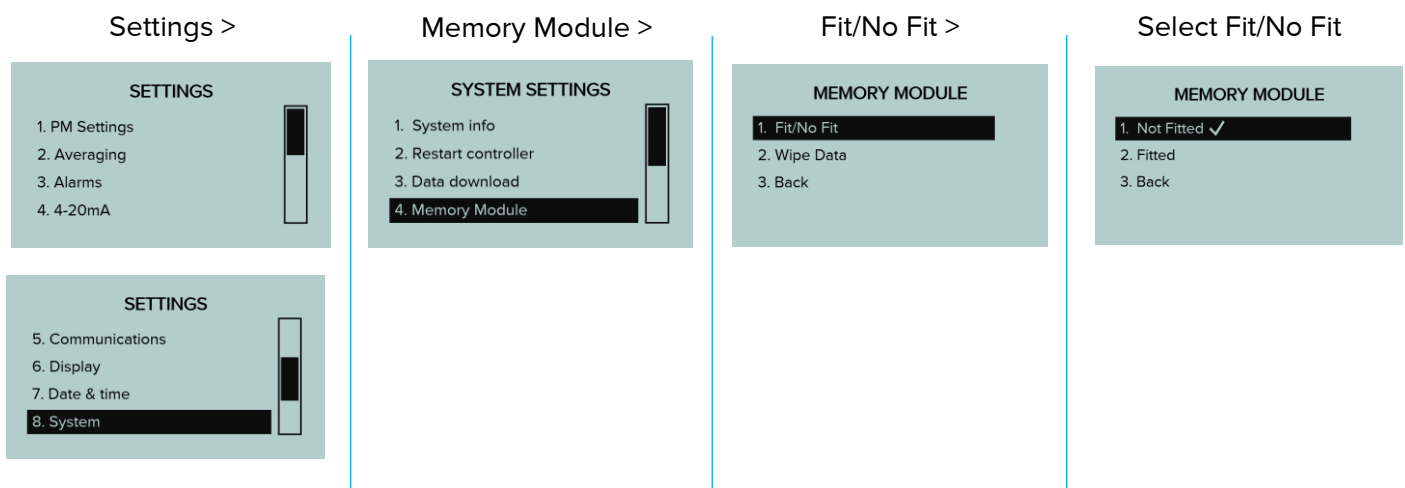

The internal Memory Module contains 8GB of storage capacity, which depending on the frequency of data collected and written may require clearing. To clear the data set stored on the instrument, follow the on-screen functions detailed below.

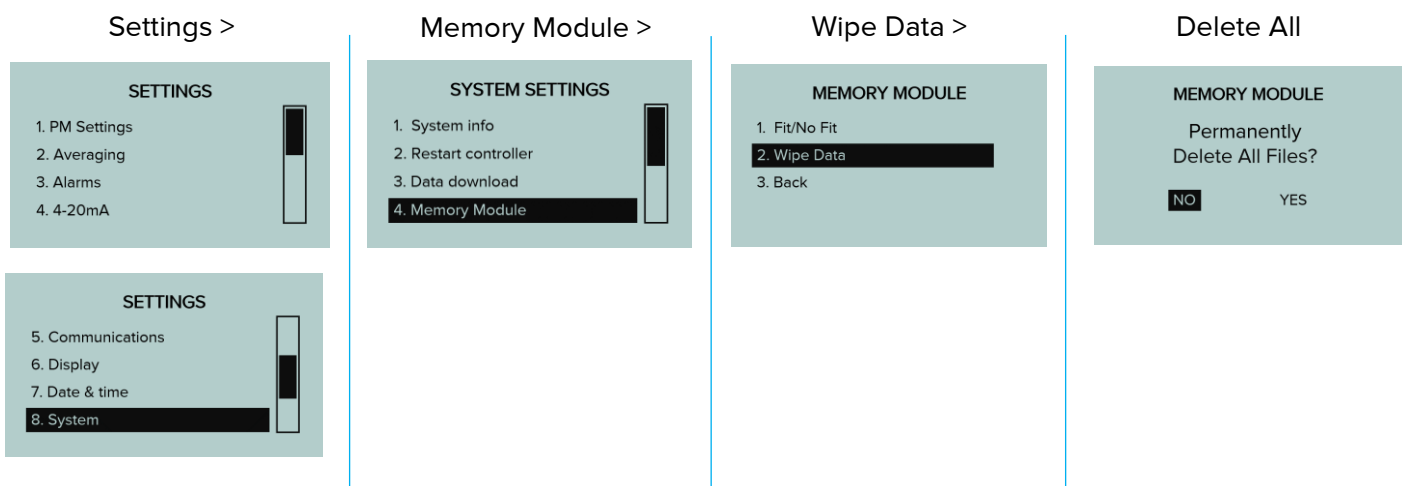

11.42 Firmware Update

On notification of firmware update and release, the Air XD and internal Memory Module can be update via the firmware update menu below. The instrument requires the update to take place via the connection of the external Air XD USB drive loaded with the latest firmware.

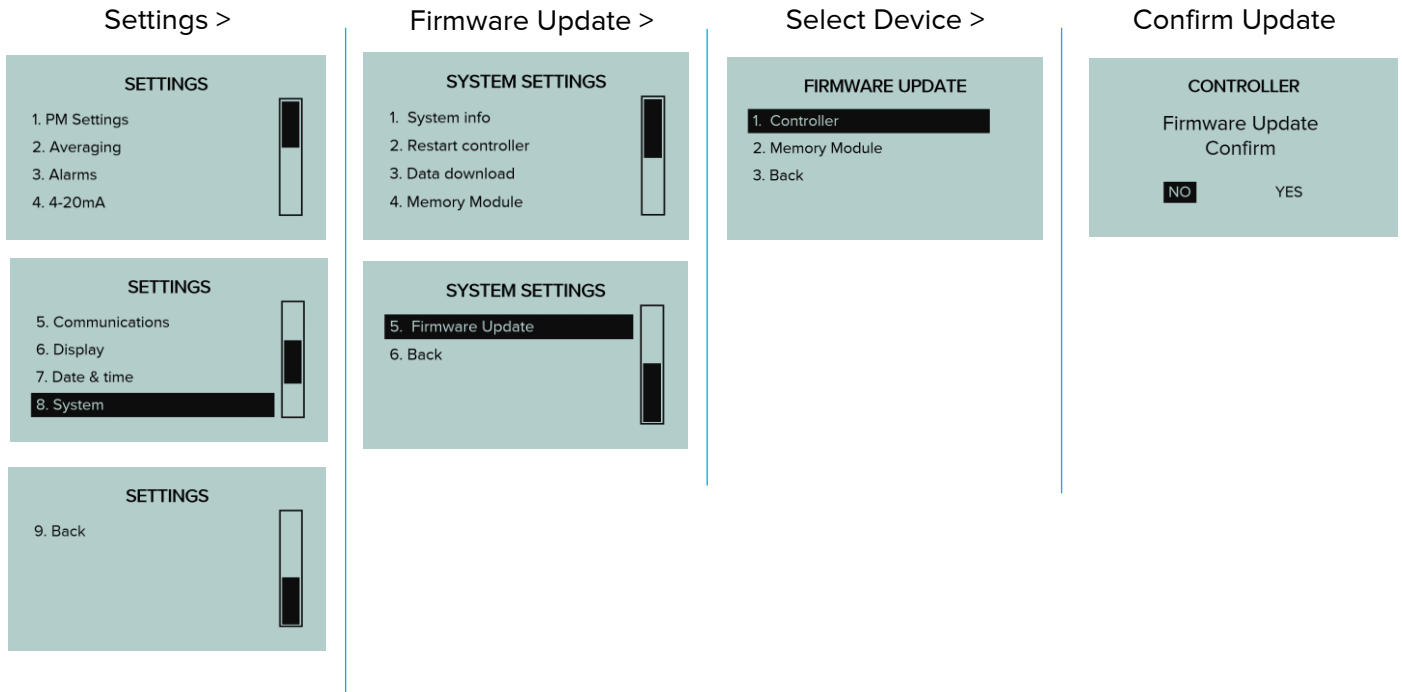

12. Instrument Configuration

12.1 Default Settings

The Air XD instrument has been programmed with factory default settings prior to delivery which are detailed in the table below.

Number of channels:	5
PM values:	PM1.0, PM2.5, PM4.25, PM10, TSP
Data averaging time 1:	15mins
Data averaging time 2:	8hrs
Display units:	µg/m ³
RS485 baud rate:	115200
RS485/Modbus:	Enabled
Ethernet:	Optional
4 to 20mA:	PM channels PM2.5 and PM4.25
4 to 20mA range:	0 - 2000 µg/m ³ or 0 - 6553.5 mg/m ³
4 to 20mA:	Mapped to Average Data
Alarms:	Disabled
Alarm thresholds:	1000 µg/m ³
Alarm 1:	Channel 3
Alarm 2:	Channel 4
Alarm latching:	Enabled

12.2 On-Site Configuration

The Air XD instrument can be configured to user requirements following the procedures outlined in section 11, using the on-device screen and buttons/user interface. The Air X application software also supports on-site custom configuration.

12.3 MODBUS Addresses

The Air XD contains the following three MODBUS registers:

Input Register (Function code 4)

This is a read-only register containing factory programmed instrument parameters, including serial numbers, firmware versions and live data sets.

Register	Description	Data Type	Units
0	Product TX number	Uint16_t	
1	Firmware Version (Major)	Uint16_t	
2	Firmware Version (Minor)	Uint16_t	
3	Firmware Version (Patch)	Uint16_t	
4	Serial Number (Characters 1 & 2)	Char	Ascii format
5	Serial Number (Characters 3 & 4)	Char	
6	Serial Number (Characters 5 & 6)	Char	
7	Serial Number (Characters 7 & 18)	Char	
8	Serial Number (Characters 9 & 10)	Char	
9	Bin 0 – 0.46 μ m	Uint16_t	Counts
10	Bin 1 – 0.66 μ m	Uint16_t	Counts
11	Bin 2 – 0.89 μ m	Uint16_t	Counts
12	Bin 3 – 1.17 μ m	Uint16_t	Counts
13	Bin 4 – 1.47 μ m	Uint16_t	Counts
14	Bin 5 – 1.80 μ m	Uint16_t	Counts
15	Bin 6 – 2.5 μ m	Uint16_t	Counts
16	Bin 7 – 3.5 μ m	Uint16_t	Counts
17	Bin 8 – 4.51 μ m	Uint16_t	Counts
18	Bin 9 – 5.76 μ m	Uint16_t	Counts
19	Bin 10 – 7.25 μ m	Uint16_t	Counts
20	Bin 11 – 9 μ m	Uint16_t	Counts
21	Bin 12 – 11 μ m	Uint16_t	Counts
22	Bin 13 – 13 μ m	Uint16_t	Counts
23	Bin 14 – 15.01 μ m	Uint16_t	Counts
24	Bin 15 – 17.01 μ m	Uint16_t	Counts
25	Bin 16 – 19.02 μ m	Uint16_t	Counts
26	Bin 17 – 21.02 μ m	Uint16_t	Counts
27	Bin 18 – 23.51 μ m	Uint16_t	Counts
28	Bin 19 – 26.51 μ m	Uint16_t	Counts
29	Bin 20 – 29.51 μ m	Uint16_t	Counts
30	Bin 21 – 32.51 μ m	Uint16_t	Counts
31	Bin 22 – 35.51 μ m	Uint16_t	Counts
32	Bin 23 – 38.51 μ m / 140 μ m extended mode	Uint16_t	Counts
33	Sampling Period	Uint16_t	0.01s/bit
34	Sample Flow Rate	Uint16_t	0.01ml/s/bit
35	Sensor Temperature	Uint16_t	0.01°C/bit
36	Sensor Humidity	Uint16_t	0.01%/bit
37	PM A Size (Lower 16 bits)	Float32_t	μ g/m ³
38	PM A Size (Upper 16 bits)	Float32_t	μ g/m ³
39	PM B Size (Lower 16 bits)	Float32_t	μ g/m ³

40	PM B Size (Upper 16 bits)	Float32_t	µg/m ³
41	PM C Size (Lower 16 bits)	Float32_t	µg/m ³
42	PM C Size (Upper 16 bits)	Float32_t	µg/m ³
43	PM D Size (Lower 16 bits)	Float32_t	µg/m ³
44	PM D Size (Upper 16 bits)	Float32_t	µg/m ³
45	Total Suspended Particulates (TSP) (Lower 16 bits)	Float32_t	µg/m ³
46	Total Suspended Particulates (TSP) (Upper 16 bits)	Float32_t	µg/m ³
47	PM A Average 1 (Lower 16 bits)		
48	PM A Average 1 (Upper 16 bits)		
49	PM B Average 1 (Lower 16 bits)		
50	PM B Average 1 (Upper 16 bits)	Float32_t	µg/m ³
51	PM C Average 1 (Lower 16 bits)	Float32_t	µg/m ³
52	PM C Average 1 (Upper 16 bits)	Float32_t	µg/m ³
53	PM D Average 1 (Lower 16 bits)	Float32_t	µg/m ³
54	PM D Average 1 (Upper 16 bits)	Float32_t	µg/m ³
55	Total Suspended Particulates Average 1 (TSP) (Lower 16 bits)	Float32_t	µg/m ³
56	Total Suspended Particulates Average 1 (TSP) (Upper 16 bits)	Float32_t	µg/m ³
57	PM A Average 2 (Lower 16 bits)	Float32_t	µg/m ³
58	PM A Average 2 (Upper 16 bits)	Float32_t	µg/m ³
59	PM B Average 2 (Lower 16 bits)	Float32_t	µg/m ³
60	PM B Average 2 (Upper 16 bits)	Float32_t	µg/m ³
61	PM C Average 2 (Lower 16 bits)	Float32_t	µg/m ³
62	PM C Average 2 (Upper 16 bits)	Float32_t	µg/m ³
63	PM D Average 2 (Lower 16 bits)	Float32_t	µg/m ³
64	PM D Average 2 (Upper 16 bits)	Float32_t	µg/m ³
65	Total Suspended Particulates Average 2 (TSP) (Lower 16 bits)	Float32_t	µg/m ³
66	Total Suspended Particulates Average 2 (TSP) (Upper 16 bits)	Float32_t	µg/m ³
67	Air XD Supply Voltage	Uint16_t	mv/bit
68	Laser Current / mA	Uint16_t	mA/bit
69	Fan Current / mA	Uint16_t	mA/bit
70	Status Register	Uint16_t	

12.4 Coil Register

(Function code 1 *read* – Function code 5 *write*)

This is a read/write register containing the instrument binary settings, including alarm status, PM units and 4-20mA output enable/disable status. Writing to this register will result in the setting being changed permanently.

Note: However, if an alarm is activated, writing to the alarm status coil will dismiss the active alarm until the alarm threshold parameters have been re-exceeded.

Register	Description	Data Type	Units
0	Channel 1 alarm status	Bool	
1	Channel 2 alarm status	Bool	
2	Channel 1 alarm latch	Bool	(1=latch, 0 auto reset)
3	Channel 2 alarm latch	Bool	(1=latch, 0 auto reset)
4	Channel 1 alarm mute	Bool	
5	Channel 2 alarm mute	Bool	
6	PM Units	Bool	(0 = $\mu\text{g}/\text{m}^3$, 1= mg/m^3)
7	TSP Extended Range	Bool	(0=false, 1=true)
8	Memory Module Fitted	Bool	(0=Not fitted, 1=1 fitted)
9	4-20mA Channel 1 Enable/Disable	Bool	0 – Disabled 1 – Enabled
10	4-20mA Channel 2 Enable/Disable	Bool	0 – Disabled 1 – Enabled

12.5 Holding Register

(Function code 3 *read* – Function code 6 *write*)

This is a read/write register containing the instrument settings and parameters, including instrument date, time, PM assignment and MODBUS settings. Writing to this register will result in the setting being changed permanently.

Note: Writing to the MODBUS settings will result in communication errors until the user has changed their local instrument MODBUS parameters to match the new setting selected on the Air XD.

Register	Description	Data Type	Units
0	Time (seconds)	Uint16_t	
1	Time (minutes)	Uint16_t	
2	Time (hours)	Uint16_t	
3	Date (date)	Uint16_t	
4	Date (month)	Uint16_t	
5	Date (year)	Uint16_t	
6	UTC offset (minutes)	Int16_t	
7	UTC offset (hours)	Int16_t	
8	PM A assignment	Uint16_t	x100
9	PM B assignment	Uint16_t	x100
10	PM C assignment	Uint16_t	x100
11	PM D assignment	Uint16_t	x100
12	Alarm 1 assignment	Uint16_t	0 – PM A Live 1 – PM B Live 2 – PM C Live 3 – PM D Live 4 – TSP Live 5 – PM A Av 1 6 – PM B Av 1 7 – PM C Av 1 8 – PM D Av 1 9 – TSP Av 1 10 – PM A Av 2 11 – PM B Av 2 12 – PM C Av 2 13 – PM D Av 2 14 – TSP Av 2
13	Alarm 2 assignment	Uint16_t	0 – PM A Live 1 – PM B Live 2 – PM C Live 3 – PM D Live 4 – TSP Live 5 – PM A Av 1 6 – PM B Av 1 7 – PM C Av 1 8 – PM D Av 1 9 – TSP Av 1 10 – PM A Av 2 11 – PM B Av 2 12 – PM C Av 2

			13 – PM D Av 2 14 – TSP Av 2
14	Alarm 1 threshold	Uint16_t	(As $\mu\text{g}/\text{m}^3$)
15	Alarm 2 threshold	Uint16_t	(As $\mu\text{g}/\text{m}^3$)
16	4-20mA Ch 1 assignment	Uint16_t	(0 = PM A 3 = PM D)
17	4-20mA Ch 2 assignment	Uint16_t	(0 = PM A 3 = PM D)
18	4-20mA Ch 1 scaling	Uint16_t	
19	4-20mA Ch 2 scaling	Uint16_t	
20	Average Ch 1 time	Uint16_t	(As minutes)
21	Average Ch 2 time	Uint16_t	(As minutes)
22	MODBUS baud rate	Uint16_t	0 = 4800 1 = 9600 2 = 14400 3 = 19200 4 = 38400 5 = 57600 6 = 115200
23	MODBUS Address	Uint8_t	

12.6 Instrument Self-Test

On initial power on, the Air XD is programmed to perform a set of initialisation tests which are listed and described below. Throughout general function, the Air XD will periodically perform these tests to ensure correct operation.

- OPC sensor comms check

Ensures communications and correct functionality of the OPC sensor.

- OPC temp sensor test

Ensures the OPC sensor is operating within the specified safe temperature limits.

- 4-20mA self-test

During instrument start up and initialisation, each 4-20mA output will perform a calibration routine which involves sweeping the output from 0-20mA before returning to 4mA. After this has been completed, the output will return to configured functionality.

- Data logging comms test

Ensures communications and correct functionality of the Air XD memory module.

- EEPROM memory test

Ensures communications and functionality of the EEPROM is correct and that custom defined user settings are not lost.

13. Maintenance

The maintenance of the Air XD must only be carried out by competent personnel. Maintenance shall be considered with reference to the local safety regulations and authorities.

13.1 Visual Checks

Periodic visual checks should be carried out to assess if there are any issues arising with the Air XD instrument. Check for:

1. External damage to the instrument. Plastic parts should not be cracked or broken which could affect the IP rating of the instrument.
2. Internal or external damage to wiring that is connected to the Air XD instrument.
3. Labels on the instrument are still in place and are not peeling or discolouring. Ensure all labels are clean by following 13.2 below.

13.2 Cleaning Labels

It is recommended to periodically clean the instrument with a damp cloth, to ensure the instrument display and keypad is clean and legible.

13.3 Particulate Entry/Exit apertures

The Air XD has been designed to allow for infrequent pressure washing during maintenance schedules. **Note:** Ensure inlet cap is closed before pressure washing the Air XD instrument.

It is important that an appropriate distance is kept between a pressure washer and all Air XD surfaces when cleaning to avoid any damage to the surface being cleaned. Care should also be taken to ensure that the underside of the instrument is not subject to the direct water jet to ensure that water does not enter the particulate flow path.

The particulate exit aperture is protected by a stainless-steel grille to minimise the ingress of flora and fauna into the Air XD instrument. It is recommended that the grille is checked and cleaned during maintenance periods to ensure that it has not become clogged with ingress that may obscure the particulate sensing airflow.

14. Troubleshooting

The following sections detail and contain information to assist with the troubleshooting of instrument functionality if required. If an issue is non-resolvable based on the information below, please contact the Trolex product support team.

14.1 High Temperature operating

The Air XD operates a protective thermal cut-out sequence when the temperature inside the instrument exceeds the maximum operating temperature specification, detailed in section 7. This protective measure is in place to maintain the lifespan and operating functionality of the optical sensor assembly when the Air XD is installed in environments with high ambient temperatures.

Note: The operating lifespan and performance of the optical sensor assembly may be reduced when the Air XD is operational at maximum temperature limits for extended periods of time.

14.2 Low Temperature Start-up

If the internal temperature of the instrument is suspected to be below -10°C , for example if it has been left powered off for a period of time in a very cold environment, damage to the optical assembly may occur when power is applied. Allow the instrument to reach safe operating temperature before applying power.

14.3 Fault Codes

The following codes relate to on-screen warnings that the Air XD will display when a fault is encountered during normal operations.

Code	Fault Name	Fault Description	Fault Check
0x0009	Failed to Load Settings	Failed to load and apply user configured settings. As standard the Air XD default settings will be applied.	Re-apply custom settings and check if unit saves and restores files. Contact Trolex or approved distributor if this fails.
0x0301	No Sensor Comms	Communications with the particulate sensor assembly has been lost.	Check 'D' type connector to sensor housing and power cycle unit.
0x0304	Fan Current Too High	Particulate sampling fan may have malfunctioned.	Check instrument is operating within rated temperature range.
0x0305	No Fan Current	Particulate sampling fan may have malfunctioned.	Check instrument is operating within rated temperature range.
0x0306	Sensor Laser Current High	Particulate sensor may have failed or operating at excessive temperatures.	Check instrument is operating within rated temperature range.
0x0307	Sensor Laser Current Low	Particulate sensor may have failed.	Contact Trolex or approved distributor.
0x0308	Sensor Temp Too High	Instrument is operating above specified temperature limits. Unit has gone into safe mode.	Reduce operating temperature below 50°C
0x0402	Lost Memory Module Comms	Communications to memory module has failed. Data logging functionality is lost.	Power cycle to reset instrument processor and retry. Contact Trolex or approved distributor if this fails.

15. Glossary and Definitions

Flow rate	The volume of fluid which passes per unit time
IP	Ingress Protection
$\mu\text{g}/\text{m}^3$	Microgram per meter cubed. The concentration of an air pollutant given in micrograms (one-millionth of a gram) per cubic meter of air
mg/m^3	Milligram per meter cubed. The concentration of an air pollutant given in milligrams (one-thousandth of a gram) per cubic meter of air
OPC	Optical particulate counter
PPM	Parts per million
Particulate Matter (PM)	General term for a mixture of solids and liquid droplets suspended in the air from typical processes including combustion, industrial activities or natural sources.
PM_x	PM_x is particulate matter X micrometer or less in diameter.
TSP	Total Suspended Particulate matter in the air measuring up to 40 micrometers for standard TSP range and up to 150 micrometers for extended TSP range.

16. Disposal

16.1 Waste of Electrical and Electronic Equipment (WEEE) Directive (2012/19/EU)



This symbol, if marked on the product or its packaging, indicates that this product must not be disposed of with general household waste. In the European Union and many other countries, separate collection systems have been set up to handle the recycling of electrical and electronic waste.

At the end of the product's life, do not dispose of any electronic sensor, component or instrument in the domestic waste. Contact Trolex or the distributor for disposal instructions.

17. Technical Support

Our UK technical services team are available to provide expert ongoing technical assistance and technical support packages tailored to your specific requirements.

Please contact our technical services team:

Tel: +44 (0)161 483 1435

Email: service@trolex.com

18. Disclaimers

The information provided in this document contains general descriptions and technical characteristics of the performance of the product. It is not intended as a substitute for and is not to be used for determining suitability or reliability of this product for specific user applications. It is the duty of any user or installer to perform the appropriate and complete risk assessment, evaluation and testing of the products with respect to the specific application or use. Trolex shall not be responsible or liable for misuse of the information contained herein. When instruments are used for applications with technical safety requirements, the relevant instructions must be followed.

All pertinent state, regional, and local safety regulations must be observed when installing and using this instrument. For reasons of safety and to help ensure compliance with documented system data, only Trolex or its affiliates should perform repairs to components.

Trolex Ltd. reserves the right to revise and update this documentation from time to time without obligation to provide notification of such revision or change. Revised documentation may be obtainable from Trolex.

Trolex Ltd. reserves the right, without notice, to make changes in equipment design or performance as progress in engineering, manufacturing or technology may warrant.

19. Revisions

Description	ECR	Date	Initials
Initial Draft Release	-	12/11/2019	KH
Revision A Release	-	26/11/2019	KH
Revision B Release – Certification Updates	5003	24/01/2020	KH

20. Feedback

If you have any suggestions for improvements or amendments, or find errors in this publication, please notify us at marketing@trolex.com.

21. Trademarks

© 2019 Trolex® Limited.

No part of this document may be reproduced in any form or by any means, electronic or mechanical, including photocopying, without express written permission of Trolex.

Trolex is a registered trademark of Trolex Limited. The use of all trademarks in this document is acknowledged.



Trolex Ltd, Newby Road, Hazel Grove, Stockport, Cheshire, SK7 5DY, UK
+44 (0) 161 483 1435 sales@trolex.com



Trolex Ltd. Newby Road, Hazel Grove, Stockport, Cheshire SK7 5DY, UK
t: +44 (0)161 483 1435 e: sales@trolex.com www.trolex.com