

Altair Mini Series

Miniature Linear LED Fixtures

Project Name: _____

Catalog No.: _____

Date: _____

Features

- Miniature profile 1/2"W x 3/8"H
- Six standard lengths from 6"– 34"
- Dimmable
- >100 Lumens per watt
- 90+ CRI
- High Brightness
- Seamless light effect from end to end
- Link-able for continuous lighting
- Easy installation (plug and play)
- Three Years Warranty

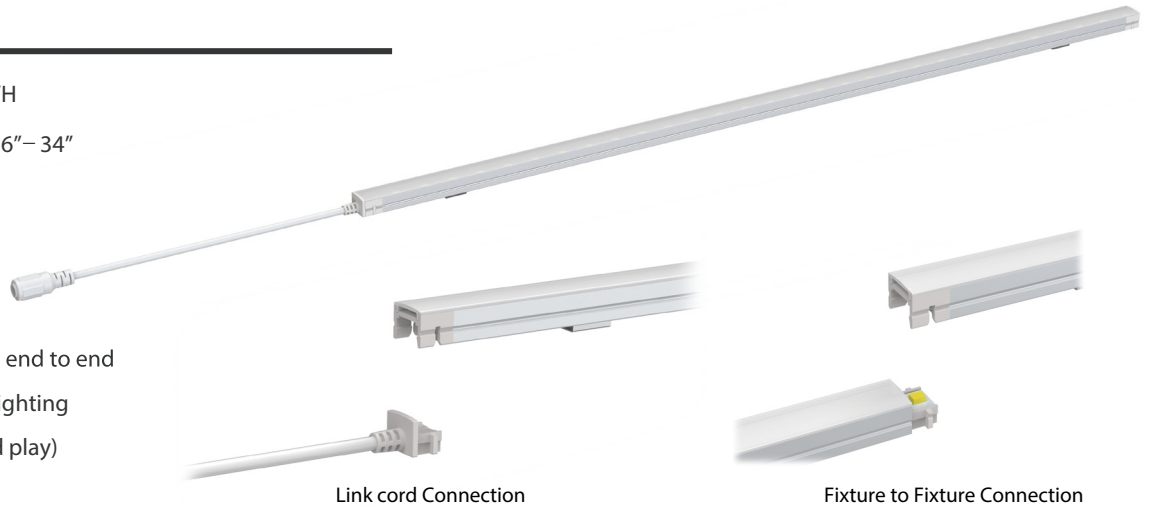

Link cord Connection

Fixture to Fixture Connection

Product Specifications

Input Voltage	24 VDC
Color Rendering Index	≥ 90 (CRI)
Color temperature	3000K, 5000K, Call for optional CCT
Operating Temperature	-22°F - 113°F/ -30°C - 45°C
Environment Rating	Dry, Damp location
Power Connection	2.1mm X 5.5mm DC Plug
Maximum Link	20 Feet
Housing	Extruded aluminum housing
Lens cover	Polycarbonate (PC) white optical type
LED Diodes	50,000 hrs maintenance free
Certification	Class 2

Applications

- Display Cases & Cabinets
- Retail Environments
- Cove & Soffit Lighting
- Shelf Lighting
- Trade Show Exhibits
- Light box & Signs
- Signs
- Edge Lighting
- Residential Closets, Kitchens, Baths

Utilizing lited 90° Modular Connector

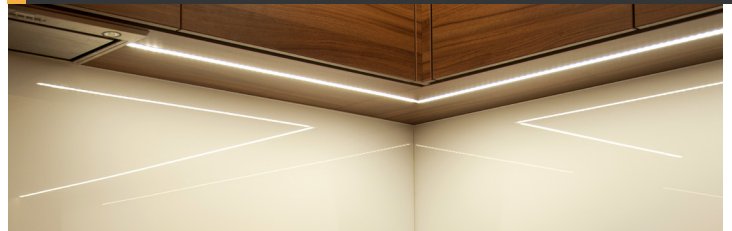

Install virtually any where with it's profile and high output





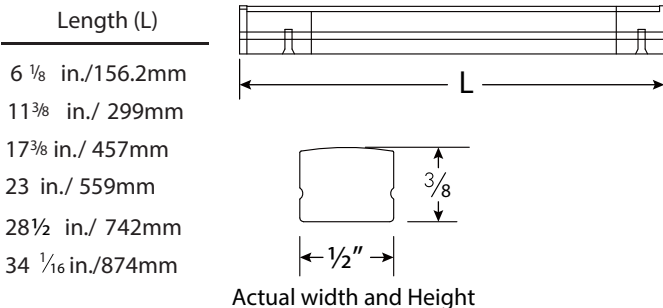





Dimensions



Ordering Information

Part Number	CCT	LM	CRI	Input (V)	Current (A)	Power (W)	Length	Width	Height
ALT06CW	5000K	200	>90	24V DC	.09	2.20	6 1/8 in.	1/2 in. 12.6 mm	3/8 in. 10 mm
ALT06WW	3000K	225					156 mm		
ALT12CW	5000K	400					11 3/8 in.		
ALT12WW	3000K	455			299 mm				
ALT18CW	5000K	600			17 3/8 in.				
ALT18WW	3000K	680			457 mm				
ALT23CW	5000K	800			23 in.				
ALT23WW	3000K	920			559 mm				
ALT29CW	5000K	1000			28 1/2 in.				
ALT29WW	3000K	1100			742 mm				
ALT34CW	5000K	1200			34 1/6 in.				
ALT34WW	3000K	1380			874 mm				

Accessories

AWBCPT72	Hardwire Power cord 72" 2.1mm x 5.5mm DC plug	
ALTFC06	Power feeder 6", 2.1mm x 5.5mm	
ALTLC06	Fixture to fixture Linkcord 6"	
ALTLC18	Fixture to fixture Linkcord 18"	
ALTLC36	Fixture to fixture Linkcord 36"	
ALTML90-CW	Modular Connector 90° Left	
ALTML90-WW	Modular Connector 90° Left	
ALTMR90-CW	Modular Connector 90° Right	
ALTMR90-WW	Modular Connector 90° Right	
ALTMTLT-CW	Modular Connector 90° Left T	
ALTMTLT-WW	Modular Connector 90° Left T	
ALTMTRT-CW	Modular Connector 90° Right T	
ALTMTRT-WW	Modular Connector 90° Right T	
ALMTTCT-CW	Modular Connector 3 Way T	
ALMTTCT-WW	Modular Connector 3 Way T	
ALTMCT4W-CW	Modular Connector 4 Way T	
ALTMCT4W-WW	Modular Connector 4 Way T	

Installation Sample

- Secure mounting clips in a straight line with provided screws.



- Snap power feed to the first fixture. If installing multiple fixtures then remove endcap. Do not remove endcap with single fixture installation.

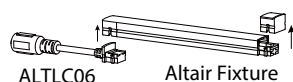

- Install fixture onto provided mounting clips. Repeat for additional fixture installation. Ensure all fixtures are securely fasten to the mounting clips.

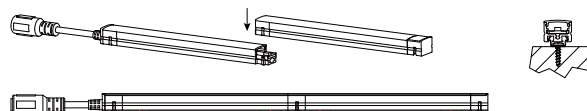

- Plug 24V DC connector the first fixture and then plug power supply to the wall outlet. Please note 24V DC power supply are sold separately.

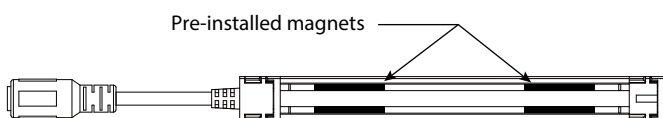
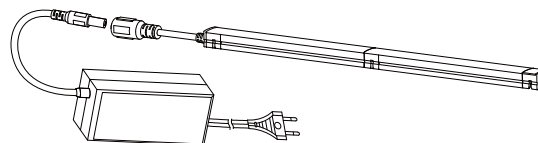

Altair can be easily installed on metallic surfaces with built in magnets recessed on the bottom of each fixture. Plug 24V DC power to complete installation.