

GoveeLife

Model: H7135

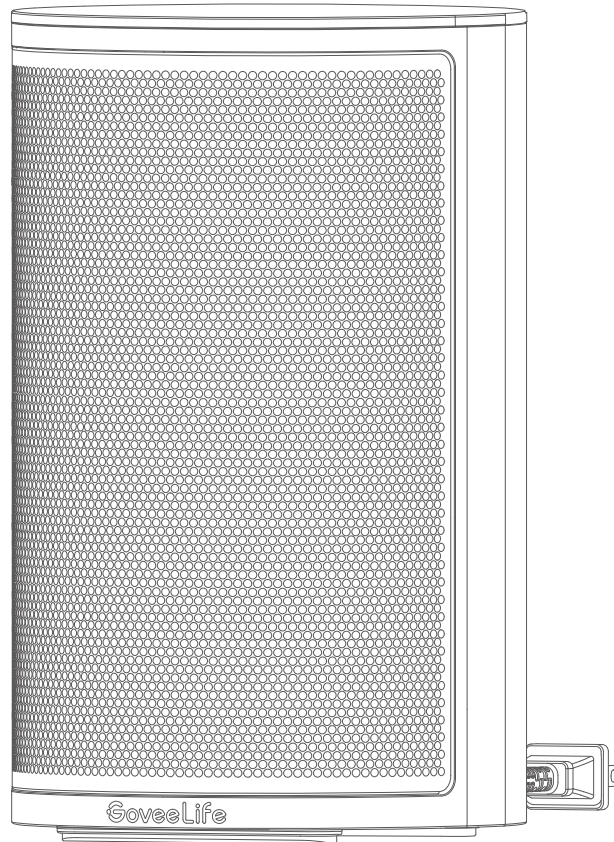

## User Manual

Smart Space Heater Lite



# Contents

## **Important Instructions**

01

## **Included in the Box**

02

## **Introduction**

Part Names

Controls

Indicator Status

Functions

02

## **Getting Started**

05

## **Govee Home App**

Downloading Govee Home App

Pairing with Govee Home App

07

## **Care & Maintenance**

Cleaning

Maintenance

08

## **Troubleshooting**

For Smart Heater

For App & Connectivity

08

## **Appendix**

After-Sales Service

Specifications

10

# IMPORTANT INSTRUCTIONS

When using electrical appliances, basic precautions should always be followed to reduce the risk of fire, electric shock, and injuries to persons, including the following:

- Read all instructions before using this heater.
- This heater is hot when in use. To avoid burns, do not let bare skin touch hot surfaces. If provided, use handles when moving this heater. Keep combustible materials, such as furniture, pillows, bedding, papers, clothes, and curtains at least 3 feet (0.9m) away from the front of the heater and keep them away from the sides and rear.
- Extreme caution is necessary when any heater is used by or near children or invalids and whenever the heater is left operating and unattended.
- Always unplug heater when not in use.
- Do not operate any heater with a damaged cord or plug or after the heater malfunctions, has been dropped or damaged in any manner. Discard heater, or return to authorized service facility for examination and/or repair.
- Do not use outdoors.
- This heater is not intended for use in bathrooms, laundry areas and similar indoor locations. Never locate the heater where it may fall into a bathtub or other water container.
- Do not run cord under carpeting. Do not cover cord with throw rugs, runners, or similar coverings. Do not route cord under furniture or appliances. Arrange cord away from traffic area and where it will not be tripped over.
- To disconnect heater, turn controls to off, then remove the plug from the outlet.
- Do not insert or allow foreign objects to enter any ventilation or exhaust opening as this may cause an electric shock or fire, or damage the heater.
- To prevent a possible fire, do not block air intakes or exhaust in any manner. Do not use on soft surfaces, like a bed, where openings may become blocked.
- A heater has hot and arcing or sparking parts inside. Do not use it in areas where gasoline, paint, or flammable liquids are used or stored.
- Use this heater only as described in this manual. Any other use not recommended by the manufacturer may cause fire, electric shock, or injuries to persons.
- Always plug heaters directly into a wall outlet/receptacle. Never use with an extension cord or relocatable power tap (outlet/power strip).
- Faulty wall outlet connections may cause the wall outlet to overheat. Be sure that the heater plug fits tightly into the outlet before using. When using the heater, check to make sure the heater plug is not overheating. If necessary, have a qualified electrician check or replace the wall outlet.
- This heater can only be used when the ambient temperature is normal. When the heater detects that the ambient temperature is too high, it will automatically shut down. Please inspect for any objects on or adjacent to the heater that may cause high temperatures.
- For US: This appliance has a polarized plug (one blade is wider than the other). To reduce the risk of electric shock, this plug is intended to fit in a polarized outlet in only one way. If the plug does not fit fully into the outlet, reverse the plug. If it still does not fit, contact a qualified electrician. Do not attempt to defeat this safety feature.
- Hyperthermia can result in death. Symptoms of hyperthermia include high body temperature, headache, nausea, vomiting, tiredness, dizziness, fainting, and rapid pulse. If you begin to experience symptoms related to hyperthermia, turn off the heater and seek medical attention.
- To avoid excessive room temperatures which can cause hyperthermia: DO NOT leave product running unattended in a confined space around infants, or individuals with reduced physical, sensory, or mental capabilities.



# SAVE THESE INSTRUCTIONS

## Included in the Box

Item	Quantity
Space Heater	1
User Manual	1
Quick Start Guide	1

## Introduction

GoveeLife Smart Space Heater Lite is suitable for bedrooms, living rooms, offices, etc. Equipped with PTC heating elements, this smart heater can heat up in 3 seconds after it is powered on, bringing you instant warmth and maximum home comfort during cold weather.

## Part Names

- a. Cover
- b. Control Panel
- c. Air Outlet
- d. Front Guard
- e. Built-in Stand
- f. Built-in Handle
- g. Air Inlet
- h. Rear Guard
- i. Power Cord & Plug

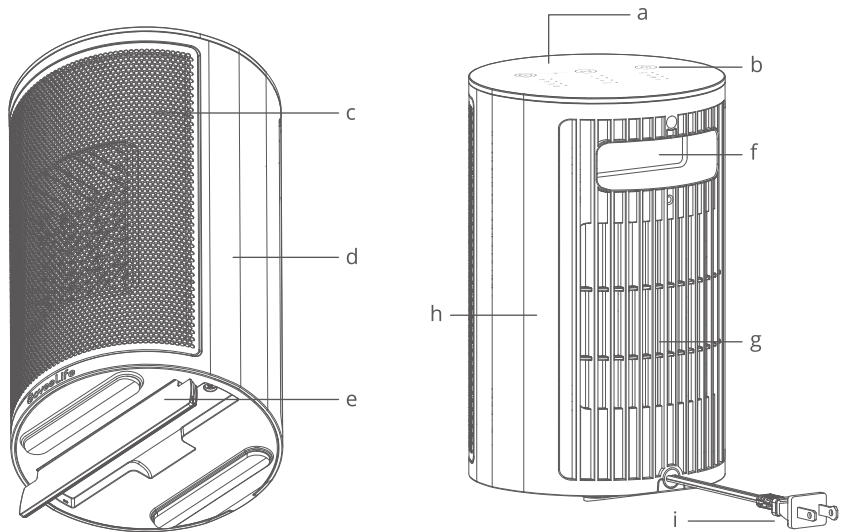

## Controls

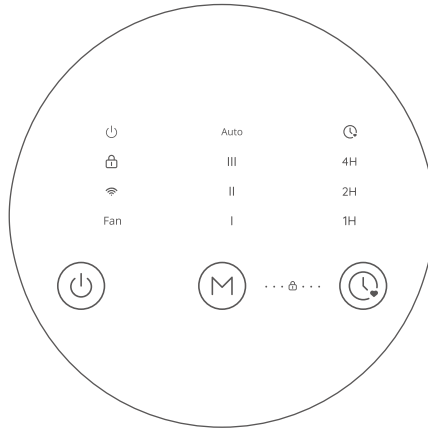

### Power Button

Touch to power on or off.

**Note:** The fan will continue working for 15 seconds after powering off to clear any residual heat.



### Mode Button

Touch to cycle through Heat Setting I, II, III, Auto Mode, and Fan Mode.



### Timer Button

Touch to set a timer. Repeatedly touch the Timer Button to set a timer from 1-7 hours. The heater will automatically turn off when the time is up. Long touch the Timer Button for 2 seconds to turn off the timer.

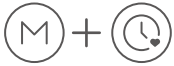

### Lock Button

Touch and hold these two buttons simultaneously for 3 seconds to turn on the Lock Mode. When the lock is active, buttons on the panel will not respond when pressed. Touch and hold both buttons for 3 seconds to turn off the Lock Mode.

**Note:**  will flash when any other button is pressed to indicate the lock is on.

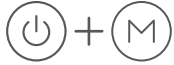

### Recovery Button

Touch and hold these two buttons simultaneously for 5 seconds until all indicators flash once to restore the heater to factory settings if it cannot function well. The heater will disconnect from Wi-Fi and Bluetooth and automatically reboot.

**Note:** After restoring the heater to factory settings, go to “My Devices” page on the app to delete this heater first, otherwise it cannot be added to the app again.

## Indicator Status

Indicator	Working Status	Light Status
I	Heat Setting I	Solid White
II	Heat Setting II	Solid White
III	Heat Setting III	Solid White
Auto	Auto Mode	Solid White
Fan	Fan Mode	Solid White
	Powered On	Solid Red
	Any Button Touch After Being Tipped Over	Flashes 3 Times
	Temperature Sensor Fails	Flashes 3 Times

Indicator	Working Status	Light Status
🔒	Safety Lock On	Solid White
	Safety Lock Triggered	Flashes White
1H 2H 4H	Timer is On	Solid White
🕒	Timer is Set via the App	Solid White
📶	Wi-Fi Connected	Solid White
All Indicators	Any Button Touch After Overheat Protection is Triggered	Flashes 3 Times

**Note:** According to related safety standards, the power indicator should always light red when the heater is working.

## Functions

### Memory Function

This heater will memorize the previous settings (heat settings, Wi-Fi connection) when it is powered off. The settings will be active again when this heater is turned on.

### 24-hour Automatic Shutdown

This heater will shut down automatically when it has been used for 24 hours straight in case the user forgets to power it off.

### Overheat Protection

When the heater detects that the ambient temperature exceeds a specific temperature, it will automatically power off.

### Tip-over and Motion Protection

When the heater is moved or knocked over, it will automatically power off and stop all functions. This protection can be dismissed by placing the heater on a flat and sturdy surface and keeping it upright before using it again.

## Getting Started

1. Remove all packaging and ensure the air inlet and outlet are not blocked by foreign objects.

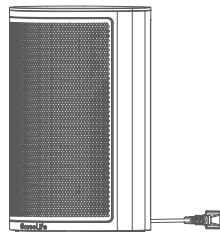

2. Only plug the heater directly into a 120V wall outlet. Do not use an extension cord.

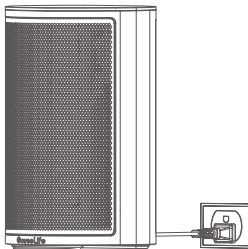

3. Ensure the power plug is firmly inserted into the outlet. An abnormal outlet connection may cause overheating.

4. Place the heater on a firm, flat, and level surface free from obstructions and at least 3ft (1 meter) away from any wall or combustible materials.

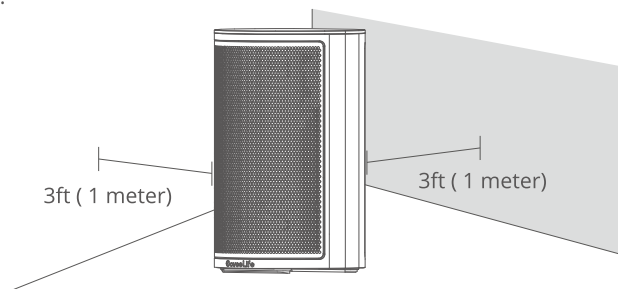

5. (Optional) You can pull out the built-in stand to adjust the elevation. After that, place the heater properly with its air outlet facing upwards and producing heat.

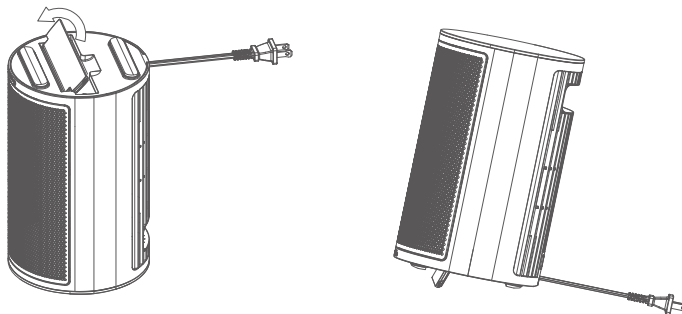

**Note:** Do not cover the heater with any cloth or covering, especially over the air inlet and outlet.

# Govee Home App

You can access more features using Govee Home App.

## Downloading Govee Home App

To download Govee Home App, scan the QR code or search for "Govee" in the Apple App Store® (iOS) or Google Play Store (Android).



Govee Home App



### Note:

- Choose "Allow" to the permissions requested when opening Govee Home App for the first time. These permissions allow the app's features to function normally and are not used to record personal, private information.
- Due to ongoing updates, **Govee Home App** may be slightly different than shown in this manual. In case of any differences, always follow the in-app instructions.

## Pairing with Govee Home App

1. Turn on your smartphone's Bluetooth. Connect to your Wi-Fi router's 2.4GHz network. 5GHz is not supported.
2. Android users turn on Location Services; IOS users choose Location ->Always On in the pop-up window while adding devices.

### Note:

- For IOS users, if you chose Location->Never, it might result in notifications/alert exceptions. It is recommended to follow Settings ->Govee Home ->Location ->Always On to obtain the best experience.
  - Govee Home WILL NOT collect, use, or share your location in any way.
3. Open Govee Home App, tap the "+" icon in the top right corner and search for "H7135."
  4. Tap the device icon and follow the in-app instructions to complete the Bluetooth and Wi-Fi connection.

**Note:**

- Method to turn off Bluetooth and Wi-Fi connection: Press and hold the Power Button and Mode Button for 5s to restore the device to factory settings, then go to "My Devices" page on the app to delete this heater first, otherwise it cannot be added to the app again.
- You can use Govee Home App to connect your heater to Amazon Alexa or Google Assistant. Follow the in-app instructions to connect to each voice assistant.
- Govee Home App is being continually updated and its features do expand.

## Care & Maintenance

### Cleaning

To achieve the best performance, clean the heater at least once during the operating season or before storing it when it will not be used for a long period of time.

- Turn the heater off and unplug it from power, then use a soft damp cloth to clean its body, air inlet, and outlet.
- Do not submerge the heater in water and never allow water to drip into it.
- Do not risk your safety to detach the heater to clean its blade. Otherwise, it may damage the heater, shorten its service life, or cause serious danger.

### Maintenance

Follow the cleaning instructions and allow all parts to dry completely before storing the heater in a cool, dry place.

## Troubleshooting

The troubleshooting section below is for solving frequently asked questions. If your problem persists, please contact Customer Support.

## For Smart Heater

Problem	Possible Causes	Solution
The heater cannot be turned on.	The power cord is not properly plugged into the outlet.	Plug the power cord into a live outlet.
The power plug is hot.	The power plug and the outlet are not securely connected.	Securely reinsert the plug into the outlet. If necessary, have a qualified electrician to check if the power plug prongs are intact.
The heater suddenly shuts down when hot air is coming out.	Failed to supply power to the heater. Overheat Protection has been triggered.	Ensure your circuit breaker or fuse is working properly. Unplug from the outlet and cool it down. Check and remove any objects on or adjacent to the heater. Wait 30 minutes before plugging the heater back in.
	Tip-over and Motion Protection has been triggered.	Place the heater on a firm and level surface free from obstructions. Keep it upright and turn it on again.
	Overheat Protection has been triggered.	Unplug from power and wait for 30 minutes for the heater to cool down before plugging back in. The heater will automatically turn on again when the surrounding temperature is below 86°F (30°C).
When the heater is standing upright and powered on, the power indicator will flash red 3 times.	Temperature sensor fails.	Contact Customer Support.

## For App & Connectivity

1. Cannot connect to Govee Home App.
  - Make sure your smartphone is powered on and is not connected with other Bluetooth devices.
  - Enable the smartphone's Location Services.
  - Try connecting with another smartphone.
  - Make sure your app is updated to the latest version.
  - Make sure you connect to your Wi-Fi router's 2.4GHz network and that the network is working correctly.
  - Make sure the Wi-Fi password you entered is correct.
  - Shorten the distance between the heater, Wi-Fi router, and the smartphone.
  - Make sure your heater and the Wi-Fi router are located away from appliances that produce electromagnetic radiation (e.g. microwave ovens, refrigerators, etc.)



- If you are using a VPN, try turning it off and then connecting the heater.
  - Disable portal authentication for your Wi-Fi network. If portal authentication is enabled, this heater will not be able to access your Wi-Fi network, and setup will fail. Portal authentication means that you need to sign in to your Wi-Fi network through a web page before you can use the Internet.
2. Cannot find the device on “Bluetooth Device Nearby” page of the app.
    - The heater may be connected with another smartphone. Disconnect it from the other smartphone first.
  3. The heater is offline.
    - Make sure the heater is plugged in and powered on, then refresh “My Devices” page in Govee Home App by swiping down on the screen.
    - Make sure your router is connected to the internet, and your smartphone’s network connection is working.
    - If the Wi-Fi password has been changed, the heater will automatically go offline. Try connecting it to the network again.
    - Delete the offline heater from Govee Home App, then add and reconfigure the heater again in the app.

## Appendix

### After-Sales Service

- 🛠️ Warranty: 12-Month Limited Warranty
- 🔍 Support: Lifetime Technical Support
- ✉️ Email: support@govee.com
- 🌐 Official Website: www.govee.com
- 📺 @Govee    📷 @govee\_official    🎵 @govee.official
- 🐦 @Goveeofficial    📘 @Govee.smarthome

### Specifications

Model	H7135
Power Voltage	120V~60Hz
Rated Power	High: 1500W Medium: 1200W Low: 900W
Net Weight	3.02lb/1.37kg
Dimension	5.9x5.9x9.5in /15.0x15.0x24.1cm

## Compliance Information

### FCC Statement

This device complies with Part 15 of the FCC Rules. Operation is subject to the following two conditions:

(1) This device may not cause harmful interference, and (2) This device must accept any interference received, including interference that may cause undesired operation.

**Warning:** Changes or modifications not expressly approved by the party responsible for compliance could void the user's authority to operate the equipment.

**NOTE:** This equipment has been tested and found to comply with the limits for a Class B digital device, pursuant to Part 15 of the FCC Rules.

These limits are designed to provide reasonable protection against harmful interference in a residential installation. This equipment generates uses and can radiate radio frequency energy and, if not installed and used in accordance with the instructions, may cause harmful interference to radio communications. However, there is no guarantee that interference will not occur in a particular installation. If this equipment does cause harmful interference to radio or television reception, which can be determined by turning the equipment off and on, the user is encouraged to try to correct the interference by one or more of the following measures:

- 1.Reorient or relocate the receiving antenna.
- 2.Increase the separation between the equipment and receiver.
- 3.Connect the equipment into an outlet on a circuit different from that to which the receiver is connected.
- 4.Consult the dealer or an experienced radio/TV technician for help.

## FCC Radiation Exposure Statement

This equipment complies with FCC radiation exposure limits set forth for an uncontrolled environment. This equipment should be installed and operated with minimum distance 20cm between the radiator & your body.

### **The following importer is the responsible party**

Name: GOVEE MOMENTS (US) TRADING LIMITED

Address: 2501 Chatham Rd Suite R Springfield IL 62704

Email: support@govee.com

Contact information: <https://www.govee.com/support>



For indoor use only

The trademark GoveeLife has been authorised to Shenzhen Qianyan Technology LTD. Copyright ©2021 Shenzhen Qianyan Technology LTD. All Rights Reserved.

The Bluetooth® word mark and logos are registered trademarks owned by Bluetooth SIG, Inc. and any use of such marks by Shenzhen Qianyan Technology LTD is under license.



Govee Home App

For FAQs and more information,  
please visit: [www.govee.com](http://www.govee.com)