

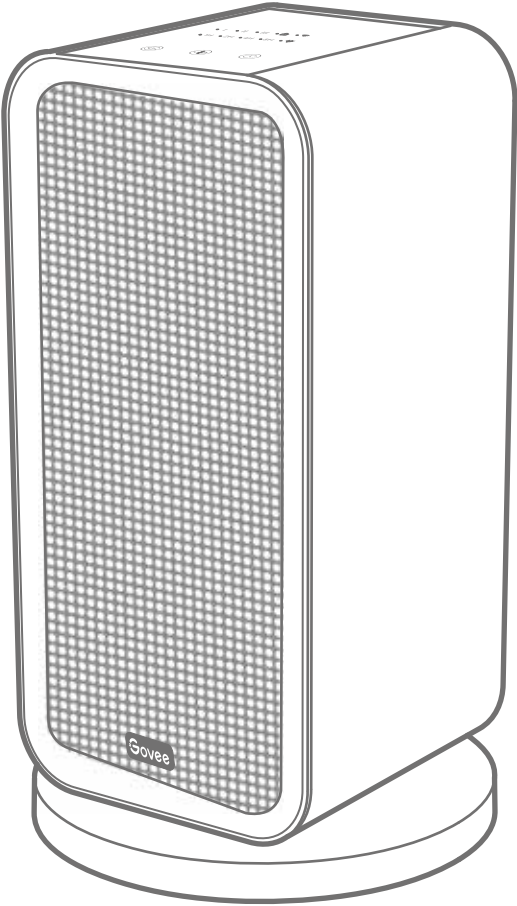

**Model:** H7130



# User Manual

Govee Smart Heater

# Table of Contents

<b>Important Instructions</b>	<b>01</b>
<b>Package Includes</b>	<b>02</b>
<b>Specifications</b>	<b>02</b>
<b>Getting to Know Your Smart Heater</b>	<b>03</b>
<b>Installing Your Heater</b>	<b>04</b>
<b>Installation Steps</b>	<b>04</b>
<b>Using Your Smart Heater</b>	<b>05</b>
<b>Pairing Your Smart Heater with the Govee Home App</b>	<b>07</b>
<b>Care &amp; Maintenance</b>	<b>08</b>
<b>Troubleshooting</b>	<b>09</b>

# IMPORTANT INSTRUCTIONS

When using electrical appliances, basic precautions should always be followed to reduce the risk of fire, electric shock, and injury to persons, including the following:

Read all instructions before using this heater.

- This heater is hot when in use. To avoid burns, do not let bare skin touch hot surfaces. Use handles when moving this heater. Keep combustible materials, such as furniture, pillows, bedding, papers, clothes, and curtains at least 3 feet (0.9 m) from the front of the heater and keep them away from the sides and rear.
- Extreme caution is necessary when any heater is used by or near children or those in need of assistance, especially whenever the heater is left operating and unattended.
- Always unplug this heater from power when not in use.
- Do not operate any heater with a damaged cord or plug or after the heater malfunctions, has been dropped or damaged in any manner. Discard heater, or return to authorized service facility for examination and/or repair.
- Do not use this heater outdoors.
- This heater is not intended to use in bathrooms, laundry areas, and any similar humid indoor environment. Never locate the heater where it may fall into a bathtub or other water containers.
- Do not run the power cord under carpeting. Do not cover the cord with throw rugs, runners, or similar coverings. Do not route the cord under furniture or appliances. Arrange the cord away from high foot-traffic areas and where it will not be tripped over.
- Always plug this heater directly into a wall outlet/receptacle. Never use it with an extension cord or relocatable power tap (outlet/power strip). Plug the heater directly into a 120V wall outlet only.
- Faulty wall outlet connections may cause the wall outlet to overheat. Be sure that the heater plug fits tightly into the outlet before using. When using the heater, check to make sure the heater plug is not overheating. If necessary, have a qualified electrician check or replace the wall outlet.
- To disconnect the heater, turn controls off, then remove the plug from the outlet.
- Do not insert or allow foreign objects to enter any ventilation or exhaust openings as this may cause an electric shock, fire, or damage to the heater.
- To prevent a possible fire, do not block the air intakes or exhaust outlets in any manner. Do not use this heater on soft surfaces such as a bed, where openings may be blocked.
- Heaters have hot and arcing or sparking parts inside. Do not use this heater in areas where gasoline, paint, or flammable liquids are used or stored.
- Use this heater only as described in this manual. Any other uses are not recommended and may cause fire, electric shock, or injury to persons.
- This heater can only be used when the ambient temperature is normal. When the heater detects that the ambient temperature is too high, it will automatically shut down. Please inspect for any objects on or adjacent to the heater that may cause high temperatures.

## SAVE THESE INSTRUCTIONS

# Package Includes

Item	Quantity
Heater	1
User Manual	1
Quick Start Guide	1
Front Base	1
Rear Base	1

# Specifications

Power Input	120V~60Hz 1500W MAX
Wattage	High: 1500W Medium: 1000W Low: 700W
Connectivity	Wi-Fi or Bluetooth
Oscillating Angle	80 Degrees
Cord Length	5.9ft / 1.8m

# Getting to Know Your Smart Heater

- 1. Panel
- 2. Buttons
- 3. Air Outlet
- 4. PTC Heating Component
- 5. Base
- 6. Handle
- 7. Air Inlet
- 8. Removable Filter
- 9. Power Switch
- 10. Power Cord & Plug
- 11. Tip-over Switch
- 12. Power Cord Slot
- 13. Pads

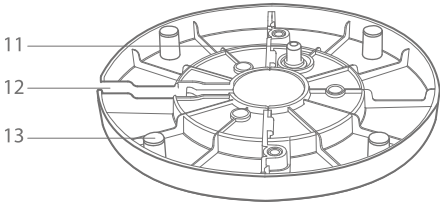
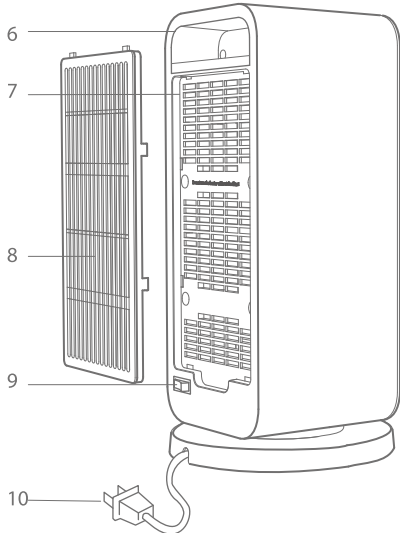
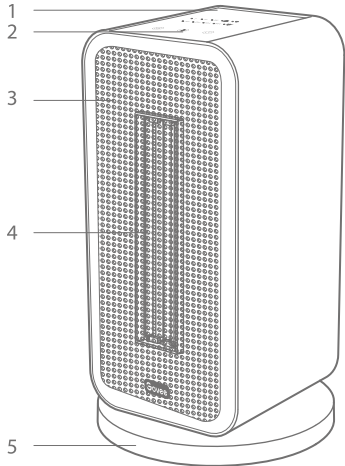

**Note:** Adequate space has been left at the base for smooth oscillation. Therefore, it is normal if the heater wobbles when pushed.

# Installing Your Heater

## Before You Install

- ① Use a  $\Phi$  5mm Phillips screwdriver to remove the 3 black screws at the bottom of the heater unit.

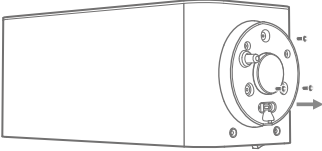

- ② Align the holes of the 2 base halves and connect them together.

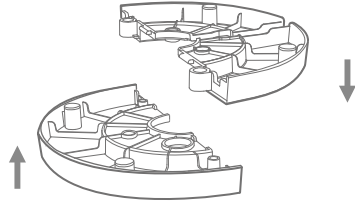

- ③ Thread the power cord through the base.

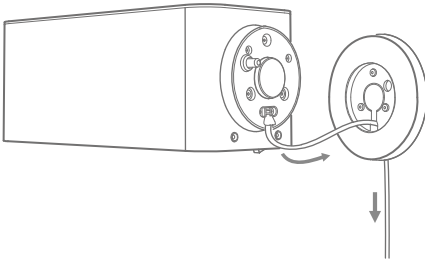

- ④ Align the base with the holes on the heater unit bottom and attach by screwing in the 3 black screws. Place the power cord into the power cord slot.

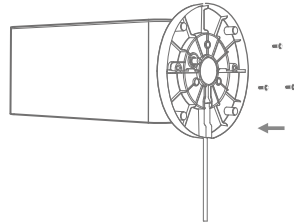

## Installation Steps

1. Make sure the Wi-Fi signal is strong and stable in the current environment.
2. Only plug the heater directly into a 120V wall outlet. Do not use an extension cord.
3. Ensure the plug is firmly inserted into the outlet. An abnormal outlet connection may cause overheating.
4. Place the heater on a firm, flat, and level surface free from obstructions and at least 3ft (1 meter) away from any wall or combustible materials.
5.  Turn on the power switch on the back. Now your heater is ready for use!

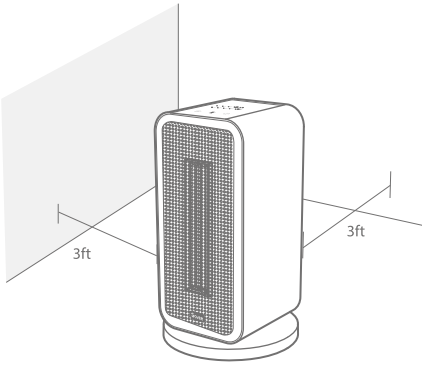

**Note:** Do not cover the heater with any cloth or covering, especially over the air inlet and outlet.

## Using Your Smart Heater

You can access additional features using the Govee Home app.

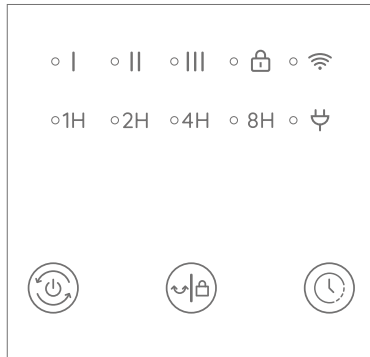



**Panel**

### 1.Button Functions







Power Button

Press  to power on. Repeatedly press  to cycle through heat settings I , II and III. Long press for 2 seconds to power off.

**Note:** The fan will continue working for 15 seconds after power off to clear any residual heat.





## Oscillation/Lock Button

Press  to turn on oscillation. Press  again to pause oscillation. Long press  for 3 seconds to turn on Lock Mode. When the lock is active, buttons on the panel will not respond to presses. Long press  again for 3 seconds to turn off the Lock Mode.



**Note:**  will flash when any other button is pressed to indicate the Lock is on.



## Timer Button

Press  to turn on the timer. Repeatedly press  to cycle through the following timers: 1H, 2H, 4H, and 8H. The heater will automatically turn off when the time is up. Long press  for 2 seconds to turn off the timer.

## 2.Indicator Light Status

Indicator		Working Status	Light Status
I	Heat Setting I	Low Heat Setting	Solid White
II	Heat Setting II	Medium Heat Setting	Solid White
III	Heat Setting III	High Heat Setting	Solid White
1H	1H Timer	Auto-off in 1 Hour	Solid White
2H	2H Timer	Auto-off in 2 Hours	Solid White
4H	4H Timer	Auto-off in 4 Hours	Solid White
8H	8H Timer	Auto-off in 8 Hours	Solid White
	Lock	Locked	Solid White
		Unlock	Dim
		Locking Reminder	Triple Flashes
	Wi-Fi Connection	Wi-Fi Connection is Ready	Slow Flash with White
		Wi-Fi is Connecting	Quick Flash with White
		Wi-Fi is Connected	Solid White
	Power	Power On	Solid Red
All Indicator Lights		Overheating Protection	Triple Flashes

**Note:** According to related safety standards, the power indicator is required to light up when the heater is plugged into power.



### 3. Other Functions

#### Memory Function

- This heater will memorize the previous settings (speed, oscillation, Wi-Fi connection) when it is powered off. The settings will be active again when this heater is turned on.

#### 24-hour Automatic Shutdown

- This heater will shut down automatically when it has been used for 24 hours straight in case the user forgets to power off.

#### Overheating Protection

- This heater will power off when the temperature exceeds 122°F (50°C). When powered off, the heater will beep three times, and all the indicators will flash three times.
- Dismiss Overheating Protection: When in Overheating Protection mode, unplug from power and wait for 30 minutes for the heater to cool down before plugging back in. The heater will automatically resume when it detects that the ambient temperature is lower than 122°F (50°C).

#### Tip-over and Motion Protection

- When the heater is moved or knocked over, it will power off and stop all functions.
- Dismiss Tip-over and Motion Protection: Place the heater on a flat, level, and sturdy surface, and while keeping it upright, try using it again.

**Note:** This heater contains a safety function in case of tip-over or unintended motion. When tip-over or motion is sensed, the heater will automatically shut off, and disconnect from Wi-Fi. The Wi-Fi will automatically reconnect once Tip-over and Motion Protection is lifted.

## Pairing Your Smart Heater with the Govee Home App

Due to ongoing updates and improvements, **Govee Home App** may be slightly different than shown in the manual. In case of any differences, follow the in-app instructions.

1. To download Govee Home app, scan the QR code or search "Govee Home" in the Apple App Store (iOS devices) or Google Play Store (Android devices).



Govee Home App



2. Turn on your smartphone's Bluetooth.
3. Open the Govee Home app, tap "+" icon in the top right corner and search "H7130".
4. Tap the device icon and follow the on-screen instructions to complete pairing.

**Note:**

- Choose to "Allow" all permissions when using Govee Home app for the first time. This app will not record your personal device use.
- You can use the Govee Home app to connect your smart heater to Amazon Alexa or Google Assistant. Follow the in-app instructions to connect to your voice assistant.
- Govee Home app is being continually updated and app features will be expanded.

## Care & Maintenance

To achieve the best performance, we suggest cleaning the heater at least once during the operating season or before storing it when it will not be in use for a long period.

### Cleaning

- Turn off the heater and then unplug it from power. Use only a soft cloth to wipe the outer surfaces gently. Do not use any cleaning agents or detergents.
- Never immerse the heater in water and allow water to drip into the motor housing. Be careful not to get the heating element and switches wet.
- The filter can be removed when cleaning. Dry the filter before installing it back in the heater. The filter must be installed before using the heater.

**Note:** Do not allow water to infiltrate into the heater's interior as this could result in a fire or electric shock hazard.

### Maintenance

For storage, you may leave the heater covered to protect it from dust. Store it in a cool, dry location and arrange the power cord away from high foot-traffic areas so that it will not be tripped over or damaged.

# Troubleshooting

**Note:** The troubleshooting section below is for solving frequently asked questions for the heater unit. If your problem persists, please contact customer support.

## For Smart Heater

Problem	Possible Cause	Solution
The plug of the heater is hot.	The power plug and the outlet are not securely connected.	Securely reinsert the plug into the socket. If necessary, you should have a qualified electrician to check whether power plug prongs are intact.
The heater cannot be turned on.	The power switch on the back is turned off.	Turn on the power switch on the back.
The heater suddenly shuts down when hot air is coming out.	Failed to supply power to the heater. The overheating protection has been triggered.	Ensure your circuit breaker or fuse is working properly. Unplug from the outlet and cool it down. Check and remove any objects on or adjacent to the heater. Wait 30 minutes before plugging the heater back in.
	The Tip-over and Motion Protection has been triggered.	Place the heater on a firm, flat, and level surface free from obstructions. Keep it upright and turn it on again.
	The Overheating Protection has been triggered.	Unplug from power and wait for 30 minutes for the heater to cool down before plugging back in. The heater will automatically turn on again when the surrounding temperature is below 122°F (50°C).
The oscillation fails around 14°F(-10°C).	The characteristics of grease in motor.	Start the oscillation again after turning on the heater for a while.

## For App & Connectivity

### 1. Cannot connect to the Govee Home app.

- Make sure the Bluetooth of your smartphone is enabled and your smartphone is not connected with other Bluetooth devices.
- Enable the smartphone's Location Services.
- Try connecting with another smartphone.
- Make sure your app is the latest version.
- Make sure your smartphone is connected to the 2.4GHz network, and confirm the network is working correctly.
- Make sure the Wi-Fi password you entered is correct.
- Shorten the distance between the heater, Wi-Fi router, and the smartphone.
- Make sure your heater and the Wi-Fi router are located away from appliances that produce electromagnetic radiation (e.g. microwave ovens, refrigerators, etc.).
- If you are using a VPN, try turning it off and then connecting the heater. Disable portal authentication for your Wi-Fi network. If portal authentication is enabled, this heater will not be able to access your Wi-Fi network, and setup will fail. Portal authentication means that you need to sign in to your Wi-Fi network through a web page before you can use the Internet.

### 2. Cannot find the heater within in nearby Bluetooth devices list.

- The heater may be connected with another smartphone. Disconnect it from the other smartphone first.

### 3. The heater is offline.

- Make sure the heater is plugged in and powered on, then refresh "My Devices" in the Govee Home app by swiping down on the screen.
- Make sure your router is connected to the internet, and your phone's network connection is working.
- If the Wi-Fi password has been changed, the heater will automatically go offline. Try connecting it to the network again.
- Delete the offline heater from the Govee Home app, then add and reconfigure the heater again in the Govee Home app.

# FCC Statement

This device complies with Part 15 of the FCC Rules. Operation is subject to the following two conditions:

- (1) this device may not cause harmful interference, and
- (2) this device must accept any interference received, including interference that may cause undesired operation.

Warning: Any Changes or modifications not expressly approved by the party responsible for compliance could void the user's authority to operate the equipment.

Note: This equipment has been tested and found to comply with the limits for a Class B digital device, pursuant to Part 15 of the FCC Rules. These limits are designed to provide reasonable protection against harmful interference in a residential installation.

This equipment generates uses and can radiate radio frequency energy and, if not installed and used in accordance with the instructions, may cause harmful interference to radio communications. However, there is no guarantee that interference will not occur in a particular installation. If this equipment does cause harmful interference to radio or television reception, which can be determined by turning the equipment off and on, the user is encouraged to try to correct the interference by one or more of the following measures:

- (1) Reorient or relocate the receiving antenna.
- (2) Increase the separation between the equipment and receiver.
- (3) Connect the equipment into an outlet on a circuit different from that to which the receiver is connected.
- (4) Consult the dealer or an experienced radio/TV technician for help.

# FCC Radio Frequency Exposure Statement

The device has been evaluated to meet general RF exposure requirements. The device can be used in fixed/mobile exposure condition. The min separation distance is 20cm.

FCC ID:2AQA6-H7130

The following importer is the responsible party

Name: GOVEE MOMENTS(US) TRADING LIMITED

Address: 13013 WESTERN AVE STE 5 BLUE ISLAND IL 60406-2448

Email: support@govee.com

Contact information: <https://www.govee.com/support>

This device complies with Industry Canada licence-exempt RSS standard(s). Operation is subject to the following two conditions:

- (1) this device may not cause interference, and
- (2) this device must accept any interference, including interference that may cause undesired operation of the device."

Le présent appareil est conforme aux CNR d'Industrie Canada applicables aux appareils radio exempts de licence. L'exploitation est autorisée aux deux conditions suivantes:

- (1) l'appareil nedoit pas produire de brouillage, et
- (2) l'utilisateur de l'appareil doit accepter tout brouillage radioélectrique subi, même si le brouillage est susceptible d'en compromettre le fonctionnement.

This Class B digital apparatus complies with Canadian ICES-003.

Cet appareil numérique de la classe B est conforme à la norme NMB-003 du Canada.

IC RF Statement:

When using the product, maintain a distance of 20cm from the body to ensure compliance with RF exposure requirements.

Lors de l'utilisation du produit, maintenez une distance de 20 cm du corps afin de vous conformer aux exigences en matière d'exposition RF.

The Bluetooth® word mark and logos are registered trademarks owned by Bluetooth SIG, Inc. and any use of such marks by Shenzhen Intellirocks Tech. Co., Ltd. is under license.

# Customer Service

 Warranty: 12-Month Limited Warranty

 Support: Lifetime Technical Support

 Email: [support@govee.com](mailto:support@govee.com)

 Official Website: [www.govee.com](http://www.govee.com)

 @Govee    @govee\_official    @govee.official

 @Goveeofficial    @Govee.smarthome



Govee Home App

For FAQs and more information,  
please visit: [www.govee.com](http://www.govee.com)