



B | SHOCKED

LOW VOLTAGE PRODUCTS by **CHINT**

 +27 11 568-7166

 sales@bshockedelectrical.co.za

 +27 11 568-7166

INDEX

Circuit Breakers	1
Miniature Circuit Breakers	
Moulded Case Circuit Breakers	
Air Circuit Breakers	
Earth Leakage	20
Surge Arrestors	22
Contractors & Thermal Overload Relays	23
Next Series Contractors & Thermal Overload Relays	35
Starters	43
Push Buttons, Pilot Lights & Indicators	47
VSD & Soft Starters	51
Isolators	53
Changeover Switches	56
Relays	58
Current Transformers	61
Voltage Transformers	62
Travel Switches	64
Float Switches	67
Terminals	67
Fuses	69
Meters	70
Switches & Sockets	71
Distribution Boxes & Enclosures	75
Photovoltaic Devices	78
Lighting	82
Power supply & Portable Power Station	85



CIRCUIT BREAKERS

Miniature Circuit Breakers

3KA MCB 1-63A	Product Code	Item Description
	RIIGBEC-1P-01A-3KA	3kA 1P1A Circuit Breaker C-Curve
	RIIGBEC-1P-02A-3KA	3kA 1P 1A Circuit Breaker C-Curve
	RIIGBEC-1P-03A-3KA	3kA 1P 3A Circuit Breaker C-Curve
	RIIGBEC-1P-04A-3KA	3kA 1P 4A Circuit Breaker C-Curve
	RIIGBEC-1P-06A-3KA	3kA 1P 6A Circuit Breaker C-Curve
	RIIGBEC-1P-10A-3KA	3kA 1P 10A Circuit Breaker C-Curve
	RIIGBEC-1P-16A-3KA	3kA 1P 16A Circuit Breaker C-Curve
	RIIGBEC-1P-20A-3KA	3kA 1P 20A Circuit Breaker C-Curve
	RIIGBEC-1P-25A-3KA	3kA 1P 25A Circuit Breaker C-Curve
	RIIGBEC-1P-32A-3KA	3kA 1P 32A Circuit Breaker C-Curve
	RIIGBEC-1P-40A-3KA	3kA 1P 40A Circuit Breaker C-Curve
	RIIGBEC-1P-50A-3KA	3kA 1P 50A Circuit Breaker C-Curve
	RIIGBEC-1P-63A-3KA	3kA 1P 63A Circuit Breaker C-Curve



6KA MCB 1-63A



Product Code	Item Description
RIIGIBC-2P-01A-3KA	3kA 2P1A Circuit Breaker C-Curve
RIIGIBC-2P-02A-3KA	3kA 2P 1A Circuit Breaker C-Curve
RIIGIBC-2P-03A-3KA	3kA 2P 3A Circuit Breaker C-Curve
RIIGIBC-2P-04A-3KA	3kA 2P 4A Circuit Breaker C-Curve
RIIGIBC-2P-06A-3KA	3kA 2P 6A Circuit Breaker C-Curve
RIIGIBC-2P-10A-3KA	3kA 2P 10A Circuit Breaker C-Curve
RIIGIBC-2P-16A-3KA	3kA 2P 16A Circuit Breaker C-Curve
RIIGIBC-2P-20A-3KA	3kA 2P 20A Circuit Breaker C-Curve
RIIGIBC-2P-25A-3KA	3kA 2P 25A Circuit Breaker C-Curve
RIIGIBC-2P-32A-3KA	3kA 2P 32A Circuit Breaker C-Curve
RIIGIBC-2P-40A-3KA	3kA 2P 40A Circuit Breaker C-Curve
RIIGIBC-2P-50A-3KA	3kA 2P 50A Circuit Breaker C-Curve
RIIGIBC-2P-63A-3KA	3kA 2P 63A Circuit Breaker C-Curve
RIIGIBC-3P-01A-3KA	3kA 3P1A Circuit Breaker C-Curve
RIIGIBC-3P-02A-3KA	3kA 3P 1A Circuit Breaker C-Curve
RIIGIBC-3P-03A-3KA	3kA 3P 3A Circuit Breaker C-Curve
RIIGIBC-3P-04A-3KA	3kA 3P 4A Circuit Breaker C-Curve
RIIGIBC-3P-06A-3KA	3kA 3P 6A Circuit Breaker C-Curve
RIIGIBC-3P-10A-3KA	3kA 3P 10A Circuit Breaker C-Curve
RIIGIBC-3P-16A-3KA	3kA 3P 16A Circuit Breaker C-Curve
RIIGIBC-3P-20A-3KA	3kA 3P 20A Circuit Breaker C-Curve
RIIGIBC-3P-25A-3KA	3kA 3P 25A Circuit Breaker C-Curve
RIIGIBC-3P-32A-3KA	3kA 3P 32A Circuit Breaker C-Curve
RIIGIBC-3P-40A-3KA	3kA 3P 40A Circuit Breaker C-Curve
RIIGIBC-3P-50A-3KA	3kA 3P 50A Circuit Breaker C-Curve
RIIGIBC-3P-63A-3KA	3kA 3P 63A Circuit Breaker C-Curve



6KA MCB 1-63A (Energy Limiting: Class 3)



Product Code	Item Description
RIIGNB1-63-1P-C01-06	6kA 1P 1A Circuit Breaker C-Curve
RIIGNB1-63-1P-C02-06	6kA 1P 1A Circuit Breaker C-Curve
RIIGNB1-63-1P-C03-06	6kA 1P 3A Circuit Breaker C-Curve
RIIGNB1-63-1P-C04-06	6kA 1P 4A Circuit Breaker C-Curve
RIIGNB1-63-1P-C06-06	6kA 1P 6A Circuit Breaker C-Curve
RIIGNB1-63-1P-C10-06	6kA 1P 10A Circuit Breaker C-Curve
RIIGNB1-63-1P-C16-06	6kA 1P 16A Circuit Breaker C-Curve
RIIGNB1-63-1P-C20-06	6kA 1P 20A Circuit Breaker C-Curve
RIIGNB1-63-1P-C25-06	6kA 1P 25A Circuit Breaker C-Curve
RIIGNB1-63-1P-C32-06	6kA 1P 32A Circuit Breaker C-Curve
RIIGNB1-63-1P-C40-06	6kA 1P 40A Circuit Breaker C-Curve
RIIGNB1-63-1P-C50-06	6kA 1P 50A Circuit Breaker C-Curve
RIIGNB1-63-1P-C63-06	6kA 1P 63A Circuit Breaker C-Curve
RIIGNB1-63-2P-C01-06	6kA 2P 1A Circuit Breaker C-Curve
RIIGNB1-63-2P-C02-06	6kA 2P 1A Circuit Breaker C-Curve
RIIGNB1-63-2P-C03-06	6kA 2P 3A Circuit Breaker C-Curve
RIIGNB1-63-2P-C04-06	6kA 2P 4A Circuit Breaker C-Curve
RIIGNB1-63-2P-C06-06	6kA 2P 6A Circuit Breaker C-Curve
RIIGNB1-63-2P-C10-06	6kA 2P 10A Circuit Breaker C-Curve
RIIGNB1-63-2P-C16-06	6kA 2P 16A Circuit Breaker C-Curve
RIIGNB1-63-2P-C20-06	6kA 2P 20A Circuit Breaker C-Curve
RIIGNB1-63-2P-C25-06	6kA 2P 25A Circuit Breaker C-Curve
RIIGNB1-63-2P-C32-06	6kA 2P 32A Circuit Breaker C-Curve
RIIGNB1-63-2P-C40-06	6kA 2P 40A Circuit Breaker C-Curve
RIIGNB1-63-2P-C50-06	6kA 2P 50A Circuit Breaker C-Curve
RIIGNB1-63-2P-C63-06	6kA 2P 63A Circuit Breaker C-Curve



6KA MCB 1-63A
(Energy Limiting: Class 3)



Product Code	Item Description
RIIGNB1-63-3P-C01-06	6kA 3P 1A Circuit Breaker C-Curve
RIIGNB1-63-3P-C02-06	6kA 3P 2A Circuit Breaker C-Curve
RIIGNB1-63-3P-C03-06	6kA 3P 3A Circuit Breaker C-Curve
RIIGNB1-63-3P-C04-06	6kA 3P 4A Circuit Breaker C-Curve
RIIGNB1-63-3P-C06-06	6kA 3P 6A Circuit Breaker C-Curve
RIIGNB1-63-3P-C10-06	6kA 3P 10A Circuit Breaker C-Curve
RIIGNB1-63-3P-C16-06	6kA 3P 16A Circuit Breaker C-Curve
RIIGNB1-63-3P-C20-06	6kA 3P 20A Circuit Breaker C-Curve
RIIGNB1-63-3P-C25-06	6kA 3P 25A Circuit Breaker C-Curve
RIIGNB1-63-3P-C32-06	6kA 3P 32A Circuit Breaker C-Curve
RIIGNB1-63-3P-C40-06	6kA 3P 40A Circuit Breaker C-Curve
RIIGNB1-63-3P-C50-06	6kA 3P 50A Circuit Breaker C-Curve
RIIGNB1-63-3P-C63-06	6kA 3P 63A Circuit Breaker C-Curve
RIIGNB1-63-4P-C2-06	6kA 4P 2A Circuit Breaker C-Curve
RIIGNB1-63-4P-C16-06	6kA 4P 16A Circuit Breaker C-Curve
RIIGNB1-63-4P-C20-06	6kA 4P 20A Circuit Breaker C-Curve
RIIGNB1-63-4P-C25-06	6kA 4P 25A Circuit Breaker C-Curve
RIIGNB1-63-4P-C32-06	6kA 4P 32A Circuit Breaker C-Curve
RIIGNB1-63-4P-C40-06	6kA 4P 40A Circuit Breaker C-Curve
RIIGNB1-63-4P-C50-06	6kA 4P 50A Circuit Breaker C-Curve
RIIGNB1-63-4P-C63-06	6kA 4P 63A Circuit Breaker C-Curve

6KA MCB 1-63A
(Energy Limiting: Class 3)



Product Code	Item Description
RIIGNB1-63-1P-D01-06	6kA 1P 1A Circuit Breaker C-Curve
RIIGNB1-63-1P-D02-06	6kA 1P 2A Circuit Breaker C-Curve
RIIGNB1-63-1P-D03-06	6kA 1P 3A Circuit Breaker C-Curve
RIIGNB1-63-1P-D04-06	6kA 1P 4A Circuit Breaker C-Curve
RIIGNB1-63-1P-D06-06	6kA 1P 6A Circuit Breaker C-Curve
RIIGNB1-63-1P-D10-06	6kA 1P 10A Circuit Breaker C-Curve
RIIGNB1-63-1P-D16-06	6kA 1P 16A Circuit Breaker C-Curve
RIIGNB1-63-1P-D20-06	6kA 1P 20A Circuit Breaker C-Curve
RIIGNB1-63-1P-D25-06	6kA 1P 25A Circuit Breaker C-Curve
RIIGNB1-63-1P-D32-06	6kA 1P 32A Circuit Breaker C-Curve
RIIGNB1-63-1P-D40-06	6kA 1P 40A Circuit Breaker C-Curve
RIIGNB1-63-1P-D50-06	6kA 1P 50A Circuit Breaker C-Curve
RIIGNB1-63-1P-D63-06	6kA 1P 63A Circuit Breaker C-Curve
RIIGNB1-63-2P-D01-06	6kA 2P 1A Circuit Breaker C-Curve
RIIGNB1-63-2P-D02-06	6kA 2P 2A Circuit Breaker C-Curve
RIIGNB1-63-2P-D04-06	6kA 2P 4A Circuit Breaker C-Curve
RIIGNB1-63-2P-D06-06	6kA 2P 6A Circuit Breaker C-Curve
RIIGNB1-63-2P-D10-06	6kA 2P 10A Circuit Breaker C-Curve
RIIGNB1-63-2P-D16-06	6kA 2P 16A Circuit Breaker C-Curve
RIIGNB1-63-2P-D20-06	6kA 2P 20A Circuit Breaker C-Curve
RIIGNB1-63-2P-D25-06	6kA 2P 25A Circuit Breaker C-Curve
RIIGNB1-63-2P-D32-06	6kA 2P 32A Circuit Breaker C-Curve
RIIGNB1-63-2P-D40-06	6kA 2P 40A Circuit Breaker C-Curve
RIIGNB1-63-2P-D50-06	6kA 2P 50A Circuit Breaker C-Curve
RIIGNB1-63-2P-D63-06	6kA 2P 63A Circuit Breaker C-Curve

6kA MCB 1-63A (Energy Limiting: Class 3)



Product Code	Item Description
RIIGNB1-63-3P-D01-06	6kA 3P 1A Circuit Breaker C-Curve
RIIGNB1-63-3P-D02-06	6kA 3P 2A Circuit Breaker C-Curve
RIIGNB1-63-3P-D03-06	6kA 3P 3A Circuit Breaker C-Curve
RIIGNB1-63-3P-D04-06	6kA 3P 4A Circuit Breaker C-Curve
RIIGNB1-63-3P-D06-06	6kA 3P 6A Circuit Breaker C-Curve
RIIGNB1-63-3P-D10-06	6kA 3P 10A Circuit Breaker C-Curve
RIIGNB1-63-3P-D16-06	6kA 3P 16A Circuit Breaker C-Curve
RIIGNB1-63-3P-D20-06	6kA 3P 20A Circuit Breaker C-Curve
RIIGNB1-63-3P-D25-06	6kA 3P 25A Circuit Breaker C-Curve
RIIGNB1-63-3P-D32-06	6kA 3P 32A Circuit Breaker C-Curve
RIIGNB1-63-3P-D40-06	6kA 3P 40A Circuit Breaker C-Curve
RIIGNB1-63-3P-D50-06	6kA 3P 50A Circuit Breaker C-Curve
RIIGNB1-63-3P-D63-06	6kA 3P 63A Circuit Breaker C-Curve

10kA MCB 1-63A (Energy Limiting: Class 3)



Product Code	Item Description
RIIGNB1-63H-1P-C01-10	10kA 1P 1A Circuit Breaker C-Curve
RIIGNB1-63H-1P-C02-10	10kA 1P 2A Circuit Breaker C-Curve
RIIGNB1-63H-1P-C04-10	10kA 1P 4A Circuit Breaker C-Curve
RIIGNB1-63H-1P-C06-10	10kA 1P 6A Circuit Breaker C-Curve
RIIGNB1-63H-1P-C10-10	10kA 1P 10A Circuit Breaker C-Curve
RIIGNB1-63H-1P-C16-10	10kA 1P 16A Circuit Breaker C-Curve
RIIGNB1-63H-1P-C20-10	10kA 1P 20A Circuit Breaker C-Curve
RIIGNB1-63H-1P-C25-10	10kA 1P 25A Circuit Breaker C-Curve
RIIGNB1-63H-1P-C32-10	10kA 1P 32A Circuit Breaker C-Curve
RIIGNB1-63H-1P-C40-10	10kA 1P 40A Circuit Breaker C-Curve
RIIGNB1-63H-1P-C50-10	10kA 1P 50A Circuit Breaker C-Curve
RIIGNB1-63H-1P-C63-10	10kA 1P 63A Circuit Breaker C-Curve



RIIGNB1-63H-2P-C10-10	10kA 2P 10A Circuit Breaker C-Curve
RIIGNB1-63H-2P-C16-10	10kA 2P 16A Circuit Breaker C-Curve
RIIGNB1-63H-2P-C20-10	10kA 2P 20A Circuit Breaker C-Curve
RIIGNB1-63H-2P-C25-10	10kA 2P 25A Circuit Breaker C-Curve
RIIGNB1-63H-2P-C32-10	10kA 2P 32A Circuit Breaker C-Curve
RIIGNB1-63H-2P-C40-10	10kA 2P 40A Circuit Breaker C-Curve
RIIGNB1-63H-2P-C50-10	10kA 2P 50A Circuit Breaker C-Curve
RIIGNB1-63H-2P-C63-10	10kA 2P 63A Circuit Breaker C-Curve



RIIGNB1-63H-3P-C06-10	10kA 3P 6A Circuit Breaker C-Curve
RIIGNB1-63H-3P-C10-10	10kA 3P 10A Circuit Breaker C-Curve
RIIGNB1-63H-3P-C16-10	10kA 3P 16A Circuit Breaker C-Curve
RIIGNB1-63H-3P-C20-10	10kA 3P 20A Circuit Breaker C-Curve
RIIGNB1-63H-3P-C25-10	10kA 3P 25A Circuit Breaker C-Curve
RIIGNB1-63H-3P-C32-10	10kA 3P 32A Circuit Breaker C-Curve
RIIGNB1-63H-3P-C40-10	10kA 3P 40A Circuit Breaker C-Curve
RIIGNB1-63H-3P-C50-10	10kA 3P 50A Circuit Breaker C-Curve
RIIGNB1-63H-3P-C63-10	10kA 3P 63A Circuit Breaker C-Curve

10kA MCB 1-63A (Energy Limiting: Class 3)



Product Code	Item Description
RIIGNB1-63-1P-C06-DC	10kA 1P 3A Circuit Breaker DC125V
RIIGNB1-63-1P-C10-DC	10kA 1P 6A Circuit Breaker DC125V
RIIGNB1-63-1P-C16-DC	10kA 1P 10A Circuit Breaker DC125V
RIIGNB1-63-1P-C20-DC	10kA 1P 16A Circuit Breaker DC125V
RIIGNB1-63-1P-C25-DC	10kA 1P 20A Circuit Breaker DC125V
RIIGNB1-63-1P-C32-DC	10kA 1P 25A Circuit Breaker DC125V
RIIGNB1-63-1P-C50-DC	10kA 1P 32A Circuit Breaker DC125V
RIIGNB1-63-1P-C63-DC	10kA 1P 50A Circuit Breaker DC125V
RIIGNB1-63-2P-C02-DC	10kA 2P 2A Circuit Breaker DC125V
RIIGNB1-63-2P-C03-DC	10kA 2P 3A Circuit Breaker DC125V
RIIGNB1-63-2P-C04-DC	10kA 2P 4A Circuit Breaker DC125V
RIIGNB1-63-2P-C06-DC	10kA 2P 6A Circuit Breaker DC125V
RIIGNB1-63-2P-C10-DC	10kA 2P 10A Circuit Breaker DC125V
RIIGNB1-63-2P-C16-DC	10kA 2P 16A Circuit Breaker DC125V
RIIGNB1-63-2P-C20-DC	10kA 2P 20A Circuit Breaker DC125V
RIIGNB1-63-2P-C25-DC	10kA 2P 25A Circuit Breaker DC125V
RIIGNB1-63-2P-C40-DC	10kA 2P 40A Circuit Breaker DC125V
RIIGNB1-63-2P-C50-DC	10kA 2P 50A Circuit Breaker DC125V
RIIGNB1-63-2P-C63-DC	10kA 2P63A Circuit Breaker DC125V



Compact MCB 10-40A



Product Code	Item Description
RIIGNBH8-40-1P+N-C10	4.5kA 1P+N 10A Compact Circuit Breaker C-Curve
RIIGNBH8-40-1P+N-C16	4.5kA 1P+N 16A Compact Circuit Breaker C-Curve
RIIGNBH8-40-1P+N-C20	4.5kA 1P+N 20A Compact Circuit Breaker C-Curve
RIIGNBH8-40-1P+N-C25	4.5kA 1P+N 25A Compact Circuit Breaker C-Curve
RIIGNBH8-40-1P+N-C32	4.5kA 1P+N 32A Compact Circuit Breaker C-Curve
RIIGNBH8-40-1P+N-C40	4.5kA 1P+N 40A Compact Circuit Breaker C-Curve

6kA MCB 80-125A



Product Code	Item Description
RIIGDZ58-1P-C080-06	6kA 1P 80A Circuit Breaker C-Curve AC/DC
RIIGDZ158-1P-C100-06	6kA 1P 100A Circuit Breaker C-Curve AC/DC
RIIGDZ158-1P-C125-06	6kA 1P 125A Circuit Breaker C-Curve AC/DC





Product Code	Item Description
RIIGDZ158-2P-C080-06	6kA 2P 80A Circuit Breaker C-Curve AC/DC
RIIGDZ158-2P-C100-06	6kA 2P 100A Circuit Breaker C-Curve AC/DC
RIIGDZ158-2P-C125-06	6kA 2P 125A Circuit Breaker C-Curve AC/DC







Product Code	Item Description
RIIGDZ158-3P-C080-06	6kA 3P 80A Circuit Breaker C-Curve AC/DC
RIIGDZ158-3P-C100-06	6kA 3P 100A Circuit Breaker C-Curve AC/DC
RIIGDZ158-3P-C125-06	6kA 3P 125A Circuit Breaker C-Curve AC/DC



Product Code	Item Description
RIIGDZ158-4P-C080-06	6kA 4P 80A Circuit Breaker C-Curve AC/DC
RIIGDZ158-4P-C100-06	6kA 4P 100A Circuit Breaker C-Curve AC/DC

6kA MCB 80-125A	Product Code	Item Description
	RIIGDZ158-1P-D080-06	6kA 1P 80A Circuit Breaker D-Curve AC/DC
	RIIGDZ158-1P-D100-06	6kA 1P 100A Circuit Breaker D-Curve AC/DC
	RIIGDZ158-1P-D125-06	6kA 1P 125A Circuit Breaker D-Curve AC/DC
	RIIGDZ158-2P-D080-06	6kA 2P 80A Circuit Breaker D-Curve AC/DC
	RIIGDZ158-2P-D100-06	6kA 2P 100A Circuit Breaker D-Curve AC/DC
	RIIGDZ158-3P-D080-06	6kA 3P 80A Circuit Breaker D-Curve AC/DC
	RIIGDZ158-3P-D100-06	6kA 3P 100A Circuit Breaker D-Curve AC/DC

10kA MCB 80-125A	Product Code	Item Description
	RIIGDZ158H-1P-C063-10	10kA 1P 63A Circuit Breaker C-Curve AC/DC
	RIIGDZ158H-1P-C080-10	10kA 1P 80A Circuit Breaker C-Curve AC/DC
	RIIGDZ158H-1P-C100-10	10kA 1P 100A Circuit Breaker C-Curve AC/DC
	RIIGDZ158H-1P-C125-10	10kA 1P 125A Circuit Breaker C-Curve AC/DC
	RIIGDZ158H-2P-C063-10	10kA 2P 63A Circuit Breaker C-Curve AC/DC
	RIIGDZ158H-2P-C080-10	10kA 2P 80A Circuit Breaker C-Curve AC/DC
	RIIGDZ158H-2P-C100-10	10kA 2P 100A Circuit Breaker C-Curve AC/DC
	RIIGDZ158H-2P-C125-10	10kA 2P 125A Circuit Breaker C-Curve AC/DC
	RIIGDZ158H-3P-C080-10	10kA 3P 80A Circuit Breaker C-Curve AC/DC
	RIIGDZ158H-3P-C100-10	10kA 3P 100A Circuit Breaker C-Curve AC/DC
	RIIGDZ158H-3P-C125-10	10kA 3P 125A Circuit Breaker C-Curve AC/DC
	RIIGDZ158H-3P-D080-10	10kA 3P 80A Circuit Breaker D-Curve AC/DC
	RIIGDZ158H-3P-D100-10	10kA 3P 100A Circuit Breaker D-Curve AC/DC

MCB Accessories	Product Code	Item Description
	RIIGST-NB1-S9	NB1 Shunt Trip Clip On 230/400V
	RIIGAUX-NB1-XF9	NB1 Side Mount Auxiliary Contact 1NO + 1NC
	RIIGUVR-NB1-V9	NB1 Side Mount Under Voltage release 230V
	RIIGTH35-7.5	Din Rail 1 Meter Length
	RIIGP-BUSBAR-1P-63A	Pin Type Busbar 1P 63A (1 Meter)
	RIIGP-BUSBAR-3P-63A	Pin Type Busbar 3P 63A (1 Meter)

Moulded Case Circuit Breakers

Fixed Type MCCB	Product Code	Item Description
	RIIGNXM-125S/3P-32A	25KA 32A 3P MCCB
	RIIGNXM-125S/3P-40A	25KA 40A 3P MCCB
	RIIGNXM-125S/3P-50A	25KA 50A 3P MCCB
	RIIGNXM-125S/3P-63A	25KA 63A 3P MCCB
	RIIGNXM-125S/3P-80A	25KA 80A 3P MCCB
	RIIGNXM-125S/3P-100A	25KA 100A 3P MCCB
	RIIGNXM-125S/3P-125A	25KA 125A 3P MCCB
	RIIGNXM-250S/3P-160A	36KA 160A 3P MCCB
	RIIGNXM-250S/3P-180A	36KA 180A 3P MCCB
	RIIGNXM-250S/3P-200A	36KA 200A 3P MCCB
	RIIGNXM-250S/3P-225A	36KA 225A 3P MCCB
	RIIGNXM-250S/3P-250A	36KA 250A 3P MCCB
	RIIGNXM-400S/3P-315A	50KA 315A 3P MCCB
	RIIGNXM-400S/3P-350A	50KA 350A 3P MCCB
	RIIGNXM-400S/3P-400A	50KA 400A 3P MCCB
	RIIGNXM-630S/3P-400A	50KA 400A 3P MCCB
	RIIGNXM-630S/3P-500A	50KA 500A 3P MCCB
	RIIGNXM-630S/3P-630A	50KA 630A 3P MCCB
	RIIGNXM-800S/3P-800A	50KA 800A 3P MCCB
	RIIGNXM-1250H/3P-1000A	70KA 1000A 3P MCCB
	RIIGNXM-1250H/3P-1250A	70KA 1250A 3P MCCB
	RIIGNXM-125H/4P-63A	50KA 63A 4P MCCB
	RIIGNXM-125H/4P-100A	50KA 100A 4P MCCB
	RIIGNXM-125H/4P-125A	50KA 125A 4P MCCB
	RIIGNXM-250H/4P-160A	50KA 160A 4P MCCB
	RIIGNXM-250H/4P-180A	50KA 180A 4P MCCB
	RIIGNXM-250H/4P-200A	50KA 200A 4P MCCB
	RIIGNXM-250H/4P-225A	50KA 225A 4P MCCB
	RIIGNXM-250H/4P-250A	50KA 250A 4P MCCB
	RIIGNXM-400H/4P-315A	70KA 315A 4P MCCB
	RIIGNXM-400H/4P-350A	70KA 350A 4P MCCB
	RIIGNXM-400H/4P-400A	70KA 400A 4P MCCB
	RIIGNXM-630H/4P-500A	70KA 500A 4P MCCB
	RIIGNXM-630H/4P-630A	70KA 630A 4P MCCB



NXM Accessories	Product Code	Item Description
	RIIGAUX-NXM-125	Auxiliary Contact NXM-125 R/Hand
	RIIGAUX-NXM-250	Auxiliary Contact NXM-250 L/Hand
	RIIGAUX-NXM-400/630	Auxiliary Contact NXM-400/630 L/Hand
	RIIGAUX-NXM-800	Auxiliary Contact NXM-800 L/Hand
	RIIGAUX-NXM-1250	Auxiliary Contact NXM-1250 L/Hand
	RIIGST-NXM-63/125 230V	Shunt Trip Release NXM-63/125 230V L/Hand
	RIIGST-NXM-250 230V	Shunt Trip Release NXM-250 AC230V R/Hand
	RIIGST-NXM-250 400V	Shunt Trip Release NXM-250 AC400V R/Hand
	RIIGST-NXM-400/630 230V	Shunt Trip Release NXM-400/630 AC230V R/Hand
	RIIGST-NXM-400/630 400V	Shunt Trip Release NXM-400/630 AC400 R/Hand
	RIIGST-NXM-800 230V	Shunt Trip Release NXM-800 AC230V R/Hand
	RIIGST-NXM-800 400V	Shunt Trip Release NXM-800 AC400V R/Hand
	RIIGST-NXM-1250 230V	Shunt Trip Release NXM-1250 AC230V L/Hand
RIIGST-NXM-1250 400V	Shunt Trip Release NXM-1250 AC400V L/Hand	
	RIIGUVR-NXM-125 230V	Under Voltage Release NXM-125 230V L/Hand
	RIIGUVR-NXM-250 230V	Under Voltage Release NXM-250 230V R/Hand
	RIIGUVR-NXM-400/630 230V	Under Voltage Release NXM-400/630 230V R/Hand
	RIIGUVR-NXM-800 230V	Under Voltage Release NXM-800 230V L/Hand
	RIIGUVR-NXM-1250 230V	Under Voltage Release NXM-1250 230V L/Hand

NXM Accessories	Product Code	Item Description
 <p>Copper connection plate for NXM-125/250 consists of 2 pcs CRV and 4 pcs STR</p> <p>Copper connection plate for NXM-400/630/800 consist of 4 pcs CRV and 2 pcs STR</p>	RIIGCU-NXM-125	Copper Connection Plate for NXM-125 3P
	RIIGCU-NXM-250	Copper Connection Plate for NXM-250 3P
	RIIGCU-NXM-400/630	Copper Connection Plate for NXM-400/630 3P
	RIIGCU-NXM-800	Copper Connection Plate for NXM-800 3P
	RIIGCU-NXM-1250	Copper Connection Plate for NXM-1250 3P
	RIIGOH-NXM-125-300mm	Operating Handle NXM-125-300mm
	RIIGOH-NXM-250-300mm	Operating Handle NXM-250-300mm
	RIIGOH-NXM-400/630-300mm	Operating Handle NXM-400/630-300mm
	RIIGOH-NXM-800-300mm	Operating Handle NXM-800-300mm
	RIIGOH-NXM-1250-300mm	Operating Handle NXM-1250-300mm
	RIIGEM-NXM-250 230V	Electro Motor NXM-250 AC230/DC220
	RIIGEM-NXM-400/630 230V	Electro Motor NXM-400/630 AC230/DC220
	RIIGEM-NXM-800 230V	Electro Motor NXM-800 AC230/DC220
	RIIGEM-NXM-1250 230V	Electro Motor NXM-1250 AC230/DC220

NM8N: Full Range of $I_{cs}=100\%I_{cu}$

Adjustable MCCB	Product Code	Item Description	
	RIIGNM8N-125S/3P-25A-TM	50KA 25A 3P MCCB (Thermal/Magnetic 0.7-1In)	
	RIIGNM8N-125S/3P-50A-TM	50KA 50A 3P MCCB (Thermal/Magnetic 0.7-1In)	
	RIIGNM8N-125S/3P-63A-TM	50KA 63A 3P MCCB (Thermal/Magnetic 0.7-1In)	
	RIIGNM8N-125S/3P-80A-TM	50KA 80A 3P MCCB (Thermal/Magnetic 0.7-1In)	
	RIIGNM8N-125S/3P-100A-TM	50KA 100A 3P MCCB (Thermal/Magnetic 0.7-1In)	
	RIIGNM8N-125S/3P-125A-TM	50KA 125A 3P MCCB (Thermal/Magnetic 0.7-1In)	
	RIIGNM8N-250S/3P-160A-TM	50KA 160A 3P MCCB (Thermal/Magnetic 0.7-1In)	
	RIIGNM8N-250S/3P-200A-TM	50KA 200A 3P MCCB (Thermal/Magnetic 0.7-1In)	
	RIIGNM8N-250S/3P-225A-TM	50KA 225A 3P MCCB (Thermal/Magnetic 0.7-1In)	
	RIIGNM8N-250S/3P-250A-TM	50KA 250A 3P MCCB (Thermal/Magnetic 0.7-1In)	
	RIIGNM8N-250H/3P-160A-TM	100KA 160A 3P MCCB (Thermal/Magnetic 0.7-1In)	
		RIIGNM8N-400S/3P-315A-TM	50KA 315A 3P MCCB (Thermal/Magnetic 0.7-1In)
		RIIGNM8N-400S/3P-350A-TM	50KA 350A 3P MCCB (Thermal/Magnetic 0.7-1In)
		RIIGNM8N-400S/3P-400A-TM	50KA 400A 3P MCCB (Thermal/Magnetic 0.7-1In)
RIIGNM8N-630S/3P-500A-TM		50KA 500A 3P MCCB (Thermal/Magnetic 0.7-1In)	
RIIGNM8N-800H/3P-630A-TM		50KA 630A 3P MCCB (Thermal/Magnetic 0.7-1In)	
RIIGNM8N-800H/3P-800A-TM		50KA 800A 3P MCCB (Thermal/Magnetic 0.7-1In)	
RIIGNM8N-1600S/3P-1000-TM		50KA 1000A 3P MCCB (Thermal/Magnetic 0.7-1In)	
RIIGNM8N-1600S/3P-1250-TM		50KA 1250A 3P MCCB (Thermal/Magnetic 0.7-1In)	
RIIGNM8N-1600S/3P-1600-TM		50KA 1600A 3P MCCB (Thermal/Magnetic 0.7-1In)	

Adjustable MCCB



Product Code	Item Description
RIIGNM8N1600S/4P-1000-TM	50KA 1000A 4P MCCB (Thermal/Magnetic 0.7-1 In)
RIIGNM8N1600S/4P-1250-TM	50KA 1250A 4P MCCB (Thermal/Magnetic 0.7-1 In)
RIIGNM8N1600S/4P-1600-TM	50KA 1600A 4P MCCB (Thermal/Magnetic 0.7-1 In)



RIIGNM8N-250S/3P-100A-EN	50KA 100A 3P MCCB (Electric 0.4-1 In)
RIIGNM8N-250S/3P-160A-EN	50KA 160A 3P MCCB (Electric 0.4-1 In)
RIIGNM8N-250S/3P-250A-EN	50KA 250A 3P MCCB (Electric 0.4-1 In)
RIIGNM8N-400S/3P-400A-EN	50KA 400A 3P MCCB (Electric 0.4-1 In)
RIIGNM8N-630S/3P-630A-EN	50KA 630A 3P MCCB (Electric 0.4-1 In)
RIIGNM8N-800S/3P-800A-EN	50KA 800A 3P MCCB (Electric 0.4-1 In)
RIIGNM8N-1600H/3P-1000A-EN	100KA 1000A 3P MCCB (Electric 0.4-1 In)
RIIGNM8N-1600H/3P-1250A-EN	100KA 1250A 3P MCCB (Electric 0.4-1 In)
RIIGNM8N-1600H/3P-1600A-EN	100KA 1600A 3P MCCB (Electric 0.4-1 In)



RIIGNM8N-800Q/3P-630-EM	70KA 6300A 3P MCCB (Electric 0.4-1 In) LCD Display
RIIGNM8N-800Q/3P-800-EM	70KA 6300A 3P MCCB (Electric 0.4-1 In) LCD Display
RIIGNM8N1600H/3P-1600-EM	1000KA 1600A 3P MCCB (Electric 0.4-1 In) & Electro Motor LSD Display
RIIGPSU22-M8	Battery Box for NM8N LCD Display (No Battery)



RIIGNM8N-250HVS/3P-250A	30KA 250A 3P AC1000V MCCB (Thermal/Magnetic 0.7-1 In)
RIIGNM8N-400HVS/3P-400A	35KA 400A 3P AC1000V MCCB (Thermal/Magnetic 0.7-1 In)
RIIGNM8N-630HVS/3P-500A	35KA 500A 3P AC1000V MCCB (Thermal/Magnetic 0.7-1 In)

NM8N Accessories







Product Code	Item Description
RIIGOH-NM8N-125-300mm	Operating Handle 300mm for NM8N-125
RIIGOH-NM8N-250-300mm	Operating Handle 300mm for NM8N-250
RIIGOH-NM8N-400/630-300mm	Operating Handle 300mm for NM8N-400/630
RIIGOH-NM8N-800-300mm	Operating Handle 300mm for NM8N-800
RIIGOH-NM8N-1600-300mm	Operating Handle 300mm for NM8N-1600
RIIGCU-NM8N-800 3P	Copper Connection Plate for NM8N-800 3P
RIIGCU-NM8N-1000/1250 3P	Copper Connection Plate for NM8N-1000/1250 3P
RIIGCU-NM8N-1000/1250 4P	Copper Connection Plate for NM8N-1000/1250 4P
RIIGCU-NM8N-1600 3P	Copper Connection Plate for NM8N-1600 3P
RIIGST-NM8N-125-240V	Shunt Trip NM8N-125 AC220-240V
RIIGST-NM8N-250/630-240V	Shunt Trip NM8N-250/630 AC220-240V
RIIGST-NM8N-800-240V	Shunt Trip NM8N-800 AC220-240V
RIIGST-NM8N-1600 240V	Shunt Trip NM8N-1600 AC220-240V
RIIGST-NM8N-1600 400V	Shunt Trip NM8N-1600 AC400V
RIIGUVR-NM8N-125 230V	Under Voltage Release NM8N-125 230V
RIIGUVR-NM8N-125 400V	Under Voltage Release NM8N-125 400V
RIIGUVR-NM8N-250-630 230V	Under Voltage Release NM8N-250-630 230V
RIIGUVR-NM8N-250-630 400V	Under Voltage Release NM8N-250-630 400V
RIIGUVR-NM8N-800 230V	Under Voltage Release NM8N-800 230V
RIIGUVR-NM8N-800 400V	Under Voltage Release NM8N-800 400V
RIIGUVR-NM8N-1600 230V	Under Voltage Release NM8N-1600 230V
RIIGUVR-NM8N-1600 400V	Under Voltage Release NM8N-1600 400V
RIIGEM-NM8N-250-230V	Electro Motor NM8N-250-AC230/DC220
RIIGEM-NM8N-400/630	Electro Motor NM8N-400/630-AC230/DC220
RIIGEM-NM8N-800-230V	Electro Motor NM8N-800 AC230/DC220
RIIGEM-NM8N-1600-24V	Electro Motor NM8N-1600 DC24
RIIGEM-NM8N-1600-230V	Electro Motor NM8N-1600 AC230/DC220



Air Circuit Breakers

ACB	Product Code	Item Description
	RIIGNA1-2000X-630A-F	ACB 80kA 3P 630A Manual/Fixed ACB AC400
	RIIGNA1-2000X630A-D	ACB 80kA 3P 630A Manual/Drawout AC400
	RIIGNA1-2000X-1000A-F	ACB 80kA 3P 1000A Manual/Fixed AC400
	RIIGNA1-2000X-1000A-D	ACB 80kA 3P 1000A Manual/Drawout AC400
	RIIGNA1-2000X-1600A-F	ACB 80kA 3P 1600A Manual/Fixed AC230
	RIIGNA1-2000X-1600A-D	ACB 80kA 3P 1600A Manual/Drawout AC400
	RIIGNA1-2000X-2000A-F	ACB 80kA 3P 2000A Manual/Fixed AC400
	RIIGNA1-2000X-2000A-D	ACB 80kA 3P 2000A Manual/Drawout AC400
	RIIGNA1-3200X-2500A-F	ACB 80kA 3P 2500A Manual/Fixed AC400
	RIIGNA1-3200X-2500A-D	ACB 80kA 3P 2500A Manual/Drawout AC400
	RIIGNA1-3200X-3200A-F	ACB 80kA 3P 3200A Manual/Fixed AC400
	RIIGNA1-3200X-3200A-D	ACB 80kA 3P 3200A Manual/Drawout AC400
	RIIGNA1-4000X-4000A-D	ACB 80kA 3P 4000A Manual/Drawout AC400
	RIIGNA1-6300X-5000A(M)-D	ACB 80kA 3P 5000A Manual/Drawout AC400



ACB Accessories	Product Code	Item Description
	RIIGAUX-NA1-4NO/4NC	NA1-Auxiliary Contacts 4NO/4NC
	RIIGMI-MCI-PLATE	Mechanical Cable Interlock Fixing Plate for NA1-2000-4000A
	RIIGMI-NA1-COMplete	Mechanical Cable Interlock for NA1-2000-6300
	RIIGST-NA1-DC24V	Shunt Trip Release NA1 DC24V
	RIIGST-NA1-110V	Shunt Trip Release NA1 AC110V
	RIIGST-NA1-240V	Shunt Trip Release NA1 AC240V
	RIIGST-NA1-400V	Shunt Trip Release NA1 AC400V
	RIIGCM-NA1-DC24V	Closing Magnet NA1-630-3200A DC24V
	RIIGCM-NA1-220V	Closing Magnet NA1-2000-6300A AC220/230V
	RIIGCM-NA1-400V	Closing Magnet NA1-2000-6300 AC400V
	RIIGUVR-NA1-230V	Under Voltage Release, NA1-2000-4000A AC230V
	RIIGUVR-NA1-400V	Under Voltage Release, NA1-2000-4000A AC400V
	RIIGEM-NA1-20-DC24	Electro Motor for NA1-630-2000A DC24V
	RIIGEM-NA1-20-110V	Electro Motor for NA1-630-2000A AC/DC110V
	RIIGEM-NA1-20-230V	Electro Motor for NA1-630-2000A AC230/DC220V
	RIIGEM-NA1-20-400V	Electro Motor for NA1-630-2000A AC400V
	RIIGEM-NA1-40-DC24	Electro Motor for NA1-2500-4000A DC24V
	RIIGEM-NA1-40-110V	Electro Motor for NA1-2500-4000A AC/DC110V
	RIIGEM-NA1-40-230V	Electro Motor for NA1-2500-4000A AC230V
	RIIGEM-NA1-40-400V	Electro Motor for NA1-2500-4000A AC400V
	RIIGEM-NA1-63-230V	Electro Motor for NA1-4000-6300A AC230/DC220V
	RIIGEM-NA1-63-400V	Electro Motor for NA1-4000-6300A AC400V

Note: When ordering Mechanical Cable Interlock for fixed type ACB, each ACB needs a specific fixing plate to be ordered.



EARTH LEAKAGE

RCCB	Product Code	Item Description
	RIIGNL1-63-1P+N-25-30mA	6kA 1P+N 25A Earth Leakage 30mA
	RIIGNL1-63-1P+N-40-30mA	6kA 1P+N 40A Earth Leakage 30mA
	RIIGNL1-63-1P+N-63-30mA	6kA 1P+N 63A Earth Leakage 30mA
	RIIGNL1-63-3P+N-25-30mA	6kA 3P+N 25A Earth Leakage 30mA
	RIIGNL1-63-3P+N-40-30mA	6kA 3P+N 40A Earth Leakage 30mA
	RIIGNL1-63-3P+N-63-30mA	6kA 3P+N 63A Earth Leakage 30mA
	RIIGNL100-4P-080-30mA	6kA 3P+N 80A Earth Leakage 30mA
	RIIGNL1-100-4P-100-30mA	6kA 3P+N 100A Earth Leakage 30mA

RCBO	Product Code	Item Description
	RIIGNB1L-40-1P+N-C20	6kA 1P+N 20A Earth Leakage 30mA OL Protection
	RIIGNB1L-40-1P+N-C40	6kA 1P+N 40A Earth Leakage 30mA OL Protection
	RIIGNB1L-63-1P+N-C63	6kA 1P+N 63A Earth Leakage 30mA OL Protection
	RIIGNB1L-40-3P+N-C25	6kA 3P+N 25A Earth Leakage 30mA OL Protection
	RIIGNB1L-40-3P+N-C40	6kA 3P+N 40A Earth Leakage 30mA OL Protection
	RIIGNB1L-63-1P+N-C50	6kA 3P+N 50A Earth Leakage 30mA OL Protection
	RIIGNB1L-63-1P+N-C63	6kA 3P+N 63A Earth Leakage 30mA OL Protection
	RIIGDZ158LE-1P+N-80A	6kA 1P+N 80A Earth Leakage 30mA OL Protection
	RIIGDZ158LE-1P+N-100A	6kA 1P+N 100A Earth Leakage 30mA OL Protection
	RIIGNXMLE-125H/4 125A	36kA 3P+N 125A Earth Leakage 30mA OL Protection
	RIIGNXMLE-160H/4 160A	36kA 3P+N 160A Earth Leakage 30mA OL Protection
	RIIGNXMLE-250H/4 250A	50kA 3P+N 250A Earth Leakage 30mA OL Protection
	RIIGNXMLE-400H/4 400A	50kA 3P+N 400A Earth Leakage 30mA OL Protection
	RIIGNXMLE-630H/4 630A	50kA 3P+N 630A Earth Leakage 30mA OL Protection

RCCB	Product Code	Item Description
	RIIGNB2LE 1P+N-25	6kA 1P+N 25A Earth Leakage 30mA OL Protection



SURGE ARRESTORS

Surge Arrestors	Product Code	Item Description
	RIIGNU6-IIG-1P-40KA-275V	Surge Arrestor 40kA 275V 1P
	RIIGNU6-IIG-1P-40KA-385V	Surge Arrestor 40kA 385V 1P
	RIIGNU6-IIG-2P-40KA/275V	Surge Arrestor 40kA 275V 2P
	RIIGNU6-IIG-2P-40KA/385V	Surge Arrestor 40kA 385V 2P
	RIIGNU6-IIG-4P-40KA/385V	Surge Arrestor 40kA 385V 4P

CONTACTORS & THERMAL OVERLOAD RELAYS

Contactors	Product Code	Item Description
	RIIGNC6-0901-240V	Contacteur 9A 3NO Main+1NC Aux 240V
	RIIGNC6-0908-240V	Contacteur 9A 2NO+2NC Main 240V
	RIIGNC6-0910-24V	Contacteur 9A 3NO Main+1NO Aux 24V
	RIIGNC6-0910-240V	Contacteur 9A 3NO Main+1NO Aux 240V
	RIIGNC6-0910-415V	Contacteur 9A 3NO Main+1NO Aux 415V
	RIIGNCH8-20A/11-230	Modular Contacteur 20A 1NO+1NC 230V
	RIIGNCH8-20A/20-230	Modular Contacteur 20A 2NO 230V
	RIIGNCH8-25A/40-230	Modular Contacteur 25A 4NO 230V
	RIIGNCH8-40A/20-230	Modular Contacteur 40A 2NO 230V
	RIIGNCH8-40A/40-230	Modular Contacteur 40A 4NO 230V
	RIIGNCH8-63A/40-230	Modular Contacteur 63A 4NO 230V
	RIIGNCH8-63A/22-230	Modular Contacteur 63 A 2NO 230V
	RIIGNCH8-20M/20-230	Modular Contacteur 20A 2NO 230V with Handle
	RIIGNCH8-25M/20-230	Modular Contacteur 25A 2NO 230V with Handle
	RIIGNCH8-40M/20-230	Modular Contacteur 40A 2NO 230V with Handle
	RIIGNCH8-40M/40-230	Modular Contacteur 40A 4NO 230V with Handle
	RIIGNCH8-63M/22-230	Modular Contacteur 63A 2NO+2NC 230V with Handle
	RIIGNCH8-63M/20-230	Modular Contacteur 63A 2NO 230V with Handle
	RIIGNCH8-63M/40-230	Modular Contacteur 63A 4NO 230V with Handle
	RIIGAUX-NCF6-22	Front Mount Auxiliary Contact for NC6 2NO+2NC

Contactors	Product Code	Item Description	
	RIIGNC1-0901-024V	Contacto 9A 3NO Main+1NC Aux 24V 50/60Hz	
	RIIGNC1-0901-240V	Contacto 9A 3NO Main+1NC Aux 240V 50/60Hz	
	RIIGNC1-0901-415V	Contacto 9A 3NO Main+1NC Aux 415V 50/60Hz	
	RIIGNC1-0904-240V	Contacto 9A 4NO Main 240V 50/60Hz	
	RIIGNC1-0904-415V	Contacto 9A 4NO Main 415V 50/60Hz	
	RIIGNC1-0908-240V	Contacto 9A 2NO+2NC Main 240V 50/60Hz	
	RIIGNC1-0908-415V	Contacto 9A 2NO+2NC Main 415V 50/60Hz	
	RIIGNC1-0910-024V	Contacto 9A 3NO Main+1NO Aux 24V 50/60Hz	
	RIIGNC1-0910-048V	Contacto 9A 3NO Main+1NO Aux 48V 50/60Hz	
	RIIGNC1-0910-110V	Contacto 9A 3NO Main+1NO Aux 110V 50/60Hz	
	RIIGNC1-0910-240V	Contacto 9A 3NO Main+1NO Aux 240V 50/60Hz	
	RIIGNC1-0910-415V	Contacto 9A 3NO Main+1NO Aux 415V 50/60Hz	
		RIIGNC1-1201-024V	Contacto 12A 3NO Main+1NC Aux 24V 50/60Hz
		RIIGNC1-1201-048V	Contacto 12A 3NO Main+1NC Aux 48V 50/60Hz
RIIGNC1-1201-110V		Contacto 12A 3NO Main+1NC Aux 110V 50/60Hz	
RIIGNC1-1201-240V		Contacto 12A 3NO Main+1NC Aux 240V 50/60Hz	
RIIGNC1-1201-415V		Contacto 12A 3NO Main+1NC Aux 415V 50/60Hz	
RIIGNC1-1204-024V		Contacto 12A 4NO Main 24V 50/60Hz	
RIIGNC1-1204-240V		Contacto 12A 4NO Main 240V 50/60Hz	
RIIGNC1-1204-415V		Contacto 12A 4NO Main 415V 50/60Hz	
RIIGNC1-1208-240V		Contacto 12A 2NO+2NC Main 240V 50/60Hz	
RIIGNC1-1208-415V		Contacto 12A 2NO+2NC Main 415V 50/60Hz	
RIIGNC1-1210-024V		Contacto 12A 3NO Main+1NO Aux 24V 50/60Hz	
RIIGNC1-1210-048V		Contacto 12A 3NO Main+1NO Aux 48V 50/60Hz	
RIIGNC1-1210-110V		Contacto 12A 3NO Main+1NO Aux 110V 50/60Hz	
RIIGNC1-1210-240V		Contacto 12A 3NO Main+1NO Aux 240V 50/60Hz	
RIIGNC1-1210-415V	Contacto 12A 3NO Main+1NO Aux 415V 50/60Hz		



Contactors	Product Code	Item Description	
	RIIGNC1-1801-024V	Contacto 18A 3NO Main+1NC Aux 24V 50/60Hz	
	RIIGNC1-1801-048V	Contacto 18A 3NO Main+1NC Aux 48V 50/60Hz	
	RIIGNC1-1801-110V	Contacto 18A 3NO Main+1NC Aux 110V 50/60Hz	
	RIIGNC1-1801-240V	Contacto 18A 3NO Main+1NC Aux 240V 50/60Hz	
	RIIGNC1-1801-415V	Contacto 18A 3NO Main+1NC Aux 415V 50/60Hz	
	RIIGNC1-1810-024V	Contacto 18A 3NO Main+1NO Aux 24V 50/60Hz	
	RIIGNC1-1810-048V	Contacto 18A 3NO Main+1NO Aux 48V 50/60Hz	
	RIIGNC1-1810-110V	Contacto 18A 3NO Main+1NO Aux 110V 50/60Hz	
	RIIGNC1-1810-240V	Contacto 18A 3NO Main+1NO Aux 240V 50/60Hz	
	RIIGNC1-1810-415V	Contacto 18A 3NO Main+1NO Aux 415V 50/60Hz	
		RIIGNC1-2501-024V	Contacto 25A 3NO Main+1NC Aux 24V 50/60Hz
		RIIGNC1-2501-110V	Contacto 25A 3NO Main+1NC Aux 110V 50/60Hz
		RIIGNC1-2501-240V	Contacto 25A 3NO Main+1NC Aux 240V 50/60Hz
		RIIGNC1-2501-415V	Contacto 25A 3NO Main+1NC Aux 415V 50/60Hz
RIIGNC1-2510-024V		Contacto 25A 3NO Main+1NO Aux 24V 50/60Hz	
RIIGNC1-2510-048V		Contacto 25A 3NO Main+1NO Aux 48V 50/60Hz	
RIIGNC1-2510-110V		Contacto 25A 3NO Main+1NO Aux 110V 50/60Hz	
RIIGNC1-2510-240V		Contacto 25A 3NO Main+1NO Aux 240V 50/60Hz	
RIIGNC1-2510-415V		Contacto 25A 3NO Main+1NO Aux 415V 50/60Hz	
RIIGNC1-2504-240V		Contacto 25A 4NO Main 240V 50/60Hz	
RIIGNC1-2504-415V		Contacto 25A 4NO Main 415V 50/60Hz	
RIIGNC1-2508-048V		Contacto 25A 2NO+2NC Main 48V 50/60Hz	
RIIGNC1-2508-240V		Contacto 25A 2NO+2NC Main 240V 50/60Hz	
RIIGNC1-2508-415V		Contacto 25A 2NO+2NC Main 415V 50/60Hz	

Product Code	Item Description
RIIGNC1-3201-024V	Contacteur 32A 3NO Main+1NC Aux 24V 50/60Hz
RIIGNC1-3201-110V	Contacteur 32A 3NO Main+1NC Aux 110V 50/60Hz
RIIGNC1-3201-240V	Contacteur 32A 3NO Main+1NC Aux 240V 50/60Hz
RIIGNC1-3201-415V	Contacteur 32A 3NO Main+1NC Aux 415V 50/60Hz
RIIGNC1-3210-024V	Contacteur 32A 3NO Main+1NO Aux 24V AC 50/60Hz
RIIGNC1-3210-048V	Contacteur 32A 3NO Main+1NO Aux 48V AC 50/60Hz
RIIGNC1-3210-110V	Contacteur 32A 3NO Main+1NO Aux 110V 50/60Hz
RIIGNC1-3210-240V	Contacteur 32A 3NO Main+1NO Aux 240V 50/60Hz
RIIGNC1-3210-415V	Contacteur 32A 3NO Main+1NO Aux 415V 50/60Hz
<hr/>	
RIIGNC1-4011-024V	Contacteur 40A 3NO Main+1NO+1NC Aux 24V 50/60Hz
RIIGNC1-4011-048V	Contacteur 40A 3NO Main+1NO+1NC Aux 48V 50/60Hz
RIIGNC1-4011-110V	Contacteur 40A 3NO Main+1NO+1NC Aux 110V 50/60Hz
RIIGNC1-4011-240V	Contacteur 40A 3NO Main+1NO+1NC Aux 240V 50/60Hz
RIIGNC1-4011-415V	Contacteur 40A 3NO Main+1NO+1NC Aux 415V 50/60Hz
RIIGNC1-4004-110V	Contacteur 40A 4NO Main 110V 50/60Hz
RIIGNC1-4004-240V	Contacteur 40A 4NO Main 240V 50/60Hz
<hr/>	
RIIGNC1-5011-024V	Contacteur 50A 3NO Main+1NO+1NC Aux 24V 50/60Hz
RIIGNC1-5011-048V	Contacteur 50A 3NO Main+1NO+1NC Aux 48V 50/60Hz
RIIGNC1-5011-110V	Contacteur 50A 3NO Main+1NO+1NC Aux 110V 50/60Hz
RIIGNC1-5011-240V	Contacteur 50A 3NO Main+1NO+1NC Aux 240V 50/60Hz
RIIGNC1-5011-415V	Contacteur 50A 3NO Main+1NO+1NC Aux 415V 50/60Hz
RIIGNC1-5004-240V	Contacteur 50A 4NO Main 240V 50/60Hz
RIIGNC1-5008-240V	Contacteur 50A 2NO+2NC Main 240V 50/60Hz

Product Code	Item Description
RIIGNC1-6511-048V	Contacteur 3NO Main+1NO+1NC Aux 48V 50/60Hz
RIIGNC1-6511-110V	Contacteur 3NO Main+1NO+1NC Aux 110V 50/60Hz
RIIGNC1-6511-240V	Contacteur 3NO Main+1NO+1NC Aux 240V 50/60Hz
RIIGNC1-6511-415V	Contacteur 3NO Main+1NO+1NC Aux 415V 50/60Hz
RIIGNC1-6504-110V	Contacteur 65A 4NO Main 110V 50/60Hz
RIIGNC1-6504-240V	Contacteur 65A 4NO Main 240V 50/60Hz
RIIGNC1-6504-415V	Contacteur 65A 4NO Main 415V 50/60Hz
RIIGNC1-6508-024V	Contacteur 65A 2NO+2NC Main 24V 50/60Hz
RIIGNC1-6508-110V	Contacteur 65A 2NO+2NC Main 110V 50/60Hz
RIIGNC1-6508-240V	Contacteur 65A 2NO+2NC Main 240V 50/60Hz
RIIGNC1-6508-415V	Contacteur 65A 2NO+2NC Main 415V 50/60Hz
<hr/>	
RIIGNC1-8011-110V	Contacteur 80A 3NO Main+1NO+1NC Aux 110V 50/60Hz
RIIGNC1-8011-240V	Contacteur 80A 3NO Main+1NO+1NC Aux 240V 50/60Hz
RIIGNC1-8011-415V	Contacteur 80A 3NO Main+1NO+1NC Aux 415V 50/60Hz
RIIGNC1-8004-110V	Contacteur 80A 4NO Main 110V 50/60Hz
RIIGNC1-8004-240V	Contacteur 80A 4NO Main 240V 50/60Hz
RIIGNC1-8008-240V	Contacteur 80A 2NO+2NC Main 240V 50/60Hz
RIIGNC1-8008-415V	Contacteur 80A 2NO+2NC Main 415V 50/60Hz
<hr/>	
RIIGNC1-9511-024V	Contacteur 95A 3NO Main+1NO+1NC Aux 24V 50/60Hz
RIIGNC1-9511-110V	Contacteur 95A 3NO Main+1NO+1NC Aux 110V 50/60Hz
RIIGNC1-9511-240V	Contacteur 95A 3NO Main+1NO+1NC Aux 240V 50/60Hz
RIIGNC1-9511-415V	Contacteur 95A 3NO Main+1NO+1NC Aux 415V 50/60Hz
RIIGNC1-9504-240V	Contacteur 95A 4NO Main 240V 50/60Hz
RIIGNC1-9508-240V	Contacteur 95A 2NO+2NC Main 240V 50/60Hz

Contactors	Product Code	Item Description
	RIIGNC1-0901Z-DC24	Contacto 09A 3NO Main+1NC Aux 24V DC
	RIIGNC1-0901Z-DC48	Contacto 09A 3NO Main+1NC Aux 48V DC
	RIIGNC1-1201Z-DC24	Contacto 12A 3NO Main+1NC Aux 24V DC
	RIIGNC1-1201Z-DC48	Contacto 12A 3NO Main+1NC Aux 48V DC
	RIIGNC1-1210Z-DC24	Contacto 12A 3NO Main+1NO Aux 24V DC
	RIIGNC1-1210Z-DC48	Contacto 12A 3NO Main+1NO Aux 48V DC
	RIIGNC1-1810Z-DC24	Contacto 18A 3NO Main+1NO Aux 24V DC
	RIIGNC1-1810Z-DC110	Contacto 18A 3NO Main+1NO Aux 110V DC
	RIIGNC1-2510Z-DC24	Contacto 25A 3NO Main+1NO Aux 24V DC
	RIIGNC1-3210Z-DC24	Contacto 32A 3NO Main+1NO Aux 24V DC
	RIIGNC1-3210Z-DC48	Contacto 32A 3NO Main+1NO Aux 48V DC

Contactors	Product Code	Item Description
	RIIGNC2-115-110V	Contacto 115A 3P 110V 50/60Hz
	RIIGNC2-115-240V	Contacto 115A 3P 240V 50/60Hz
	RIIGNC2-115-400V	Contacto 115A 3P 400V 50/60Hz
	RIIGNC2-150-110V	Contacto 150A 3P 110V 50/60Hz
	RIIGNC2-150-240V	Contacto 150A 3P 240V 50/60Hz
	RIIGNC2-150-400V	Contacto 150A 3P 400V 50/60Hz
	RIIGNC2-150/4P-240V	Contacto 150A 4P 240V 50/60Hz
	RIIGNC2-185-240V	Contacto 185A 3P 240V 50/60Hz
	RIIGNC2-185-400V	Contacto 185A 3P 400V 50/60Hz
	RIIGNC2-225-240V	Contacto 225A 3P 240V 50/60Hz
	RIIGNC2-225-400V	Contacto 225A 3P 400V 50/60Hz
	RIIGNC2-225/4P-240V	Contacto 225A 4P 240V 50/60Hz
	RIIGNC2-265-110V	Contacto 265A 3P 110V 50/60Hz
	RIIGNC2-265-240V	Contacto 265A 3P 240V 50/60Hz
	RIIGNC2-265-400V	Contacto 265A 3P 400V 50/60Hz
	RIIGNC2-265/4P-240V	Contacto 265A 4P 240V 50/60Hz

Contactors	Product Code	Item Description
	RIIGNC2-330-240V	Contacto 330A 3P 240V 50/60Hz
	RIIGNC2-330-400V	Contacto 330A 3P 400V 50/60Hz
	RIIGNC2-330/4P-240V	Contacto 330A 4P 240V 50/60Hz
	RIIGNC2-400-240V	Contacto 400A 3P 240V 50/60Hz
	RIIGNC2-400-400V	Contacto 400A 3P 240V 50/60Hz
	RIIGNC2-400/4P-240V	Contacto 400A 4P 240V 50/60Hz
	RIIGNC2-500-240V	Contacto 500A 3P 240V 50/60Hz
	RIIGNC2-500-400V	Contacto 500A 3P 400V 50/60Hz
	RIIGNC2-630-240V	Contacto 630A 3P 240V 50/60Hz
	RIIGNC2-630-400V	Contacto 630A 3P 400V 50/60Hz
	RIIGNC2-630/4P-240V	Contacto 630A 4P 240V 50/60Hz
	RIIGNC2-800-240V	Contacto 800A 3P 240V 50/60Hz
	RIIGNC2-800-400V	Contacto 800A 3P 400V 50/60Hz

Vacuum Contactors	Product Code	Item Description
	RIIGNC9-250-110V	Vacuum Contactor 250A 110V
	RIIGCJX1-225/22-110V	Vacuum Contactor 225A 3NO Main+2NO+2NC Aux 110V AC/DC
	RIIGCJX1-225/22-220V	Vacuum Contactor 225A 3NO Main+2NO+2NC Aux 220V AC/DC
	RIIGCJX1-225/22-380V	Vacuum Contactor 225A 3NO Main+2NO+2NC Aux 380V AC/DC
	RIIGCJX1-265/22-110V	Vacuum Contactor 265A 3NO Main+2NO+2NC Aux 110V AC/DC
	RIIGCJX1-265/22-220V	Vacuum Contactor 265A 3NO Main+2NO+2NC Aux 220V AC/DC
	RIIGCJX1-265/22-380V	Vacuum Contactor 265A 3NO Main+2NO+2NC Aux 380V AC/DC
	RIIGCJX1-300/22-110V	Vacuum Contactor 300A 3NO Main+2NO+2NC Aux 110V AC/DC
	RIIGCJX1-300/22-220V	Vacuum Contactor 300A 3NO Main+2NO+2NC Aux 220V AC/DC
	RIIGCJX1-300/22-380V	Vacuum Contactor 300A 3NO Main+2NO+2NC Aux 380V AC/DC

Vacuum Contactors



Product Code	Item Description
RIIGCJX1-400/22-110V	Vacuum Contactor 400A 3NO Main+2NO+2NC Aux 110V AC/DC
RIIGCJX1-400/22-220V	Vacuum Contactor 400A 3NO Main+2NO+2NC Aux 220V AC/DC
RIIGCJX1-400/22-380V	Vacuum Contactor 400A 3NO Main+2NO+2NC Aux 380V AC/DC
RIIGCJX1-500/22-110V	Vacuum Contactor 500A 3NO Main+2NO+2NC Aux 110V AC/DC
RIIGCJX1-500/22-220V	Vacuum Contactor 500A 3NO Main+2NO+2NC Aux 220V AC/DC
RIIGCJX1-500/22-380V	Vacuum Contactor 500A 3NO Main+2NO+2NC Aux 380V AC/DC
RIIGCJX1-630/44-110V	Vacuum Contactor 630A 3NO Main+2NO+2NC Aux 110V AC/DC
RIIGCJX1-630/44-220V	Vacuum Contactor 630A 3NO Main+2NO+2NC Aux 220V AC/DC
RIIGCJX1-630/44-380V	Vacuum Contactor 630A 3NO Main+2NO+2NC Aux 380V AC/DC
RIIGCJX1-820/44-110V	Vacuum Contactor 820A 3NO Main+2NO+2NC Aux 110V AC/DC
RIIGCJX1-820/44-220V	Vacuum Contactor 820A 3NO Main+2NO+2NC Aux 220V AC/DC
RIIGCJX1-820/44-380V	Vacuum Contactor 820A 3NO Main+2NO+2NC Aux 380V AC/DC

Contactor Accessories



Product Code	Item Description
RIIGAUX-F4-11	Top Mount Auxiliary Contact 1NO+1NC
RIIGAUX-F4-02	Top Mount Auxiliary Contact 2NC
RIIGAUX-F4-20	Top Mount Auxiliary Contact 2NO
RIIGAUX-F4-22	Top Mount Auxiliary Contact 2NO+2NC
RIIGAUX-F4-13	Top Mount Auxiliary Contact 1NO+3NC
RIIGAUX-F4-31	Top Mount Auxiliary Contact 3NO+1NC
RIIGAUX-F4-04	Top Mount Auxiliary Contact 4NC
RIIGAUX-F4-40	Top Mount Auxiliary Contact 4NO
RIIGAUX-F5-D02	T/Mount Breaking Time Delay 0.1-30s
RIIGTIM-F5-T02	T/Mount Making Time Delay 0.1-30s
RIIGTIM-F5-T04	T/Mount Making Time Delay 10-180s
RIIGAUX-NCF-11C	Side Mount Auxiliary Contact

Fixed Type MCCB



Product Code	Item Description
RIIGMI-NC1-09/32	Mechanical Interlock for NC1-09/32
RIIGMI-NC1-40/85	Mechanical Interlock for NC1-40/85
RIIGMI-NC1-80/95	Mechanical Interlock for NC1-80/95
RIIGMI-NC1-8004/9504	Mechanical Interlock for NC1-8004/9504
RIIGMI-NC2-115/150	Horizontal Mechanical Interlock for NC2-115/150
RIIGMI-NC2-185/225	Horizontal Mechanical Interlock for NC2-185/225
RIIGMI-NC2-265/500	Horizontal Mechanical Interlock for NC2-265/500
RIIGMI-NC2-630/800	Mechanical Interlock for NC2-630/800
RIIGCO-NC1-09/18-024	Coil for NC1-09/18 24VAC
RIIGCO-NC1-09/18-036	Coil for NC1-09/18 36VAC
RIIGCO-NC1-09/18-048	Coil for NC1-09/18 48VAC
RIIGCO-NC1-09/18-110	Coil for NC1-09/18 110VAC
RIIGCO-NC1-09/18-240	Coil for NC1-09/18 240VAC
RIIGCO-NC1-09/18-415	Coil for NC1-09/18 415VAC
RIIGCO-NC1-09/18-525	Coil for NC1-09/18 525VAC
RIIGCO-NC1-25/32-024	Coil for NC1-25/32 24VAC
RIIGCO-NC1-25/32-036	Coil for NC1-25/32 36VAC
RIIGCO-NC1-25/32-048	Coil for NC1-25/32 48VAC
RIIGCO-NC1-25/32-110	Coil for NC1-25/32 110VAC
RIIGCO-NC1-25/32-240	Coil for NC1-25/32 240VAC
RIIGCO-NC1-25/32-415	Coil for NC1-25/32 415VAC
RIIGCO-NC1-25/32-525	Coil for NC1-25/32 525VAC
RIIGCO-NC1-40/95-024	Coil for NC1-40/95 24VAC
RIIGCO-NC1-40/95-036	Coil for NC1-40/95 36VAC
RIIGCO-NC1-40/95-048	Coil for NC1-40/95 48VAC
RIIGCO-NC1-40/95-110	Coil for NC1-40/95 110VAC
RIIGCO-NC1-40/95-240	Coil for NC1-40/95 240VAC
RIIGCO-NC1-40/95-415	Coil for NC1-40/95 415VAC
RIIGCO-NC1-40/95-525	Coil for NC1-40/95 525VAC



Contactor Accessories	Product Code	Item Description
	RIIGCO-NC2-115/150-110V	Coil for NC2-115/150 110VAC
	RIIGCO-NC2-115/150-240V	Coil for NC2-115/150 240VAC
	RIIGCO-NC2-115/150-400V	Coil for NC2-115/150 400VAC
	RIIGCO-NC2-185/225-110V	Coil for NC2-185/225 110VAC
	RIIGCO-NC2-185/225-240V	Coil for NC2-185/225 240VAC
	RIIGCO-NC2-185/225-400V	Coil for NC2-185/225 400VAC
	RIIGCO-NC2-265/330-110V	Coil for NC2-265/330 110VAC
	RIIGCO-NC2-265/330-240V	Coil for NC2-265/330 240VAC
	RIIGCO-NC2-265/330-400V	Coil for NC2-265/330 400VAC
	RIIGCO-NC2-400-110V	Coil for NC2-400 110VAC
	RIIGCO-NC2-400-230V	Coil for NC2-400 230VAC
	RIIGCO-NC2-400-400V	Coil for NC2-400 400VAC
	RIIGCO-NC2-500-110V	Coil for NC2-500 110VAC
	RIIGCO-NC2-500-240V	Coil for NC2-500 240VAC
	RIIGCO-NC2-500-400V	Coil for NC2-500 400VAC
	RIIGCO-NC2-630-110V	Coil for NC2-630 110VAC
	RIIGCO-NC2-630-240V	Coil for NC2-630 240VAC
	RIIGCO-NC2-630-400V	Coil for NC2-630 400VAC
	RIIGCO-NC2-630/4P-240V	Coil for NC2-630/4P & 800A 3P 240VAC
	RIIGCO-NC2-630/4P-400V	Coil for NC2-630/4P & 800A 3P 400VAC
	RIIGCO-NC2-115Z/150Z-110VDC	Coil for NC2-115Z/150Z 110VDC
	RIIGCO-NC2-115Z/150Z-220VDC	Coil for NC2-115Z/150Z 220VDC
	RIIGCO-NC2-185Z/225Z-110VDC	Coil for NC2-185Z/225Z 110VDC
	RIIGCO-NC2-185Z/225Z-220VDC	Coil for NC2-185Z/225Z 220VDC
	RIIGCO-NC2-265Z/330Z-110VDC	Coil for NC2-265Z/330Z 110VDC
	RIIGCO-NC2-265Z/330Z-220VDC	Coil for NC2-265Z/330Z 220VDC



Thermal Overload Relays

Thermal Overload Relays	Product Code	Item Description
	RIIGNR2-11.5/2.5-4A	Thermal Overload Relay 2.5-4A for NC6
	RIIGNR2-25/0.25-0.4A	Thermal Overload Relay 0.25-0.4A
	RIIGNR2-25/0.4-0.63A	Thermal Overload Relay 0.4-0.63A
	RIIGNR2-25/0.63-1A	Thermal Overload Relay 0.63-1A
	RIIGNR2-25/1-1.6A	Thermal Overload Relay 1.0-1.6A
	RIIGNR2-25/1.6-2.5A	Thermal Overload Relay 1.6-2.5A
	RIIGNR2-25/2.5-4A	Thermal Overload Relay 2.5-4A
	RIIGNR2-25/4-6A	Thermal Overload Relay 4-6A
	RIIGNR2-25/5.5-8A	Thermal Overload Relay 5.5-8.0A
	RIIGNR2-25/7-10A	Thermal Overload Relay 7-10A
	RIIGNR2-25/9-13A	Thermal Overload Relay 9-13A
	RIIGNR2-25/12-18A	Thermal Overload Relay 12-18A
	RIIGNR2-25/17-25A	Thermal Overload Relay 17-25A
	RIIGNR2-25/23-32A	Thermal Overload Relay 23-32A
	RIIGNR2-35/23-32A	Thermal Overload Relay 23-32A
	RIIGNR2-35/28-26A	Thermal Overload Relay 28-36A



Technical Data:

Items		Model	NC1-09	NC1-12	NC1-18	NC1-25	NC1-32	NC1-40	NC1-50	NC1-65	NC1-80	NC1-95	NC2-115	NC2-150
Rated operational Current (A)	400 (380)V	AC-3	9A	12A	18A	25A	32A	40A	50A	65A	80A	95A	115A	150A
Power of controlled motor (AC-3)	kW	230 (220)V AC	2.2	3	4	5.5	N/A	N/A	N/A	N/A	N/A	N/A	N/A	N/A
		400 (380)V AC	4	5.5	7.5	11	15	18.5	22	30	37	45	55	75

Relevant contactor calculated at 415V		NC1-09 and NC1-12							NC1-12	NC1-18	NC1-25		NC1-32	NC1-40	NC1-50	NC1-65	NC1-80	NC1-95	NC2-115	NC2-150
Running current for motor ratings indicated at specific voltage	kW	0.37	0.55	0.75	1.1	1.5	2.2	4	5.5	7.5	10	11	15	18.5	22	30	37	45	55	75
	230V in A	1.3	1.9	2.6	3.8	5.2	7.6	13.9	19.1	N/A	N/A	N/A	N/A	N/A	N/A	N/A	N/A	N/A	N/A	N/A
	415V in A	0.9	1.4	1.8	2.4	3.3	4.7	8	11	14.3	19	20.5	28	34	40	54	66	76	95	128



Next series

CONTACTORS & THERMAL OVERLOAD RELAYS

Thermal Overload Relays	Product Code	Item Description
	RIIGNR2-93/23-32A	Thermal Overload Relay 23-32A
	RIIGNR2-93/30-40A	Thermal Overload Relay 30-40A
	RIIGNR2-93/37-50A	Thermal Overload Relay 37-50A
	RIIGNR2-93/48-65A	Thermal Overload Relay 48-65A
	RIIGNR2-93/55-70A	Thermal Overload Relay 55-70A
	RIIGNR2-93/63-80A	Thermal Overload Relay 63-80A
	RIIGNR2-93/80-93A	Thermal Overload Relay 80-93A
	RIIGNR2-150/80-104A	Thermal Overload Relay 80-104A
	RIIGNR2-150/95-120A	Thermal Overload Relay 95-120A
	RIIGNR2-150/110-150A	Thermal Overload Relay 110-150A
	RIIGNR2-200/100-160A	Thermal Overload Relay 100-160A
	RIIGNR2-200/125-200A	Thermal Overload Relay 125-200A
	RIIGNR2-630/200-315A	Thermal Overload Relay 200-315A

Thermal Overload Relays Accessories	Product Code	Item Description
	RIIGMB-NR2-25	MB-2 base Mounting Block for NR2-25
	RIIGMB-NR2-36	MB-3 base Mounting Block for NR2-36
	RIIGMB-NR2-93	MB-4 base Mounting Block for NR2-93

NEXT Series Contactors	Product Code	Item Description
	RIIGNXC-06M01-240V	Contactor 6A 3NO Main + 1NC Aux 240V
	RIIGNXC-06M01-415V	Contactor 6A 3NO Main + 1NC Aux 415V
	RIIGNXC-06M10-24V	Contactor 6A 3NO Main + 1NO Aux 24V
	RIIGNXC-06M10-240V	Contactor 6A 3NO Main + 1NO Aux 240V
	RIIGNXC-06M10-415V	Contactor 6A 3NO Main + 1NO Aux 415V
	RIIGNXC-09M01-240V	Contactor 9A 3NO Main + 1NC Aux 240V
	RIIGNXC-09M01-415V	Contactor 9A 3NO Main + 1NC Aux 415V
	RIIGNXC-09M10-24V	Contactor 9A 3NO Main + 1NO Aux 24V
	RIIGNXC-09M10-240V	Contactor 9A 3NO Main + 1NO Aux 240V
	RIIGNXC-09M10-415V	Contactor 9A 3NO Main + 1NO Aux 415V

NEXT Series Contactors	Product Code	Item Description
	RIIGNXC-06-24V	Contactor 6A 3NO Main + 1NO + 1NC Aux 24V
	RIIGNXC-06-240V	Contactor 6A 3NO Main + 1NO + 1NC Aux 240V
	RIIGNXC-06-415V	Contactor 6A 3NO Main + 1NO + 1NC Aux 415V
	RIIGNXC-09-24V	Contactor 9A 3NO Main + 1NO + 1NC Aux 24V
	RIIGNXC-09-240V	Contactor 9A 3NO Main + 1NO + 1NC Aux 240V
	RIIGNXC-09-415V	Contactor 9A 3NO Main + 1NO + 1NC Aux 415V
	RIIGNXC-09/4-240V	Contactor 9A 4NO Main 240V
	RIIGNXC-09/4-415V	Contactor 9A 4NO Main 415V
	RIIGNXC-09/22-240V	Contactor 9A 2NO + 2NC Main 240V
	RIIGNXC-09/22-415V	Contactor 9A 2NO + 2NC Main 415V

NEXT Series Contactors	Product Code	Item Description
	RIIGNXC-12-24V	Contact 12A 3NO Main + 1NO + 1NC Aux 24V
	RIIGNXC-12-48V	Contact 12A 3NO Main + 1NO + 1NC Aux 48V
	RIIGNXC-12-110V	Contact 12A 3NO Main + 1NO + 1NC Aux 110V
	RIIGNXC-12-240V	Contact 12A 3NO Main + 1NO + 1NC Aux 240V
	RIIGNXC-12-415V	Contact 12A 3NO Main + 1NO + 1NC Aux 415V
	RIIGNXC-12/4-240V	Contact 12A 4NO Main 240V
	RIIGNXC-12/4-415V	Contact 12A 4NO Main 415V
	RIIGNXC-12/22-240V	Contact 12A 2NO + 2NC Main 240V
	RIIGNXC-12/22-415V	Contact 12A 2NO + 2NC Main 415V
	RIIGNXC-18-24V	Contact 18A 3NO Main + 1NO + 1NC Aux 24V
	RIIGNXC-18-48V	Contact 18A 3NO Main + 1NO + 1NC Aux 48V
	RIIGNXC-18-110V	Contact 18A 3NO Main + 1NO + 1NC Aux 110V
	RIIGNXC-18-240V	Contact 18A 3NO Main + 1NO + 1NC Aux 240V
	RIIGNXC-18-415V	Contact 18A 3NO Main + 1NO + 1NC Aux 415V
	RIIGNXC-25-24V	Contact 25A 3NO Main + 1NO + 1NC Aux 24V
	RIIGNXC-25-48V	Contact 25A 3NO Main + 1NO + 1NC Aux 48V
	RIIGNXC-25-110V	Contact 25A 3NO Main + 1NO + 1NC Aux 110V
	RIIGNXC-25-240V	Contact 25A 3NO Main + 1NO + 1NC Aux 240V
	RIIGNXC-25-415V	Contact 25A 3NO Main + 1NO + 1NC Aux 415V
	RIIGNXC-25/4-240V	Contact 25A 4NO Main 240V
	RIIGNXC-25/4-415V	Contact 25A 4NO Main 415V
	RIIGNXC-25/22-240V	Contact 25A 2NO + 2NC Main 240V
	RIIGNXC-25/22-415V	Contact 25A 2NO + 2NC Main 415V

NEXT Series Contactors	Product Code	Item Description
	RIIGNXC-32-24V	Contact 32A 3NO Main + 1NO + 1NC Aux 24V
	RIIGNXC-32-48V	Contact 32A 3NO Main + 1NO + 1NC Aux 48V
	RIIGNXC-32-110V	Contact 32A 3NO Main + 1NO + 1NC Aux 110V
	RIIGNXC-32-240V	Contact 32A 3NO Main + 1NO + 1NC Aux 240V
	RIIGNXC-32-415V	Contact 32A 3NO Main + 1NO + 1NC Aux 415V
	RIIGNXC-40-24V	Contact 40A 3NO Main + 1NO + 1NC Aux 24V
	RIIGNXC-40-48V	Contact 40A 3NO Main + 1NO + 1NC Aux 48V
	RIIGNXC-40-110V	Contact 40A 3NO Main + 1NO + 1NC Aux 110V
	RIIGNXC-40-240V	Contact 40A 3NO Main + 1NO + 1NC Aux 240V
	RIIGNXC-40-415V	Contact 40A 3NO Main + 1NO + 1NC Aux 415V
	RIIGNXC-50-24V	Contact 50A 3NO Main + 1NO + 1NC Aux 24V
	RIIGNXC-50-48V	Contact 50A 3NO Main + 1NO + 1NC Aux 48V
	RIIGNXC-50-110V	Contact 50A 3NO Main + 1NO + 1NC Aux 110V
	RIIGNXC-50-240V	Contact 50A 3NO Main + 1NO + 1NC Aux 240V
	RIIGNXC-50-415V	Contact 50A 3NO Main + 1NO + 1NC Aux 415V
	RIIGNXC-50/4-240V	Contact 50A 4NO Aux 240V
	RIIGNXC-50/4-415V	Contact 50A 4NO Aux 415V
	RIIGNXC-50/22-240V	Contact 50A 2NO + 2NC Aux 240V
	RIIGNXC-50/22-415V	Contact 50A 2NO + 2NC Aux 415V
	RIIGNXC-65-24V	Contact 65A 3NO Main + 1NO + 1NC Aux 24V
	RIIGNXC-65-48V	Contact 65A 3NO Main + 1NO + 1NC Aux 48V
	RIIGNXC-65-110V	Contact 65A 3NO Main + 1NO + 1NC Aux 110V
	RIIGNXC-65-240V	Contact 65A 3NO Main + 1NO + 1NC Aux 240V
	RIIGNXC-65-415V	Contact 65A 3NO Main + 1NO + 1NC Aux 415V
	RIIGNXC-65/4-240V	Contact 65A 4NO Aux 240V
	RIIGNXC-65/4-415V	Contact 65A 4NO Aux 415V
	RIIGNXC-65/22-240V	Contact 65A 2NO + 2NC Main 240V
	RIIGNXC-65/22-415V	Contact 65A 2NO + 2NC Main 415V

NEXT Series Contactors	Product Code	Item Description
	RIIGNXC-85-110V	Contact 85A 3NO Main +1NO + 1NC Aux 110V
	RIIGNXC-85-240V	Contact 85A 3NO Main +1NO + 1NC Aux 240V
	RIIGNXC-85-415V	Contact 85A 3NO Main +1NO + 1NC Aux 415V
	RIIGNXC-80/4-240V	Contact 80A 4NO Main 240V
	RIIGNXC-80/4-415V	Contact 80A 4NO Main 415V
	RIIGNXC-80/22-240V	Contact 80A 2NO + 2NC Main 240V
	RIIGNXC-80/22-415V	Contact 80A 2NO + 2NC Main 415V
		RIIGNXC-100-110V
RIIGNXC-100-240V		Contact 100A 3NO Main + 1NO + 1NC Aux 240V
RIIGNXC-100-415V		Contact 100A 3NO Main + 1NO + 1NC Aux 415V
RIIGNXC-95/4-240V		Contact 95A 4NO Main 240V
RIIGNXC-95/4-415V		Contact 95A 4NO Main 415V
RIIGNXC-95/22-240V		Contact 95A 2NO + 2NC Main 240V
RIIGNXC-95/22-415V		Contact 95A 2NO + 2NC Main 415V
		RIIGNXC-09M01/Z-DC24V
	RIIGNXC-09M01/Z-DC48V	Contact 09A 3NO Main + 1NC Aux 48V DC
	RIIGNXC-09M10/Z-DC24V	Contact 09A 3NO Main + 1NO Aux 24V DC
	RIIGNXC-12M01/Z-DC24V	Contact 12A 3NO Main + 1NC Aux 24V DC
	RIIGNXC-12M01/Z-DC48V	Contact 12A 3NO Main + 1NC Aux 48V DC
	RIIGNXC-12M10/Z-DC24V	Contact 12A 3NO Main + 1NO Aux 24V DC
		RIIGNXC-120-110V
RIIGNXC-120-240V		Contact 120A 3P 3NO Main + 2NO + 2NC 240V
RIIGNXC-120-415V		Contact 120A 3P 3NO Main + 2NO + 2NC 415V
RIIGNXC-160-110V		Contact 160A 3P 3NO Main + 2NO + 2NC 110V
RIIGNXC-160-240V		Contact 160A 3P 3NO Main + 2NO + 2NC 240V
RIIGNXC-160-415V		Contact 160A 3P 3NO Main + 2NO + 2NC 415V

NEXT Series Contactors	Product Code	Item Description
	RIIGNXC-185-240V	Contact 185A 3P 3NO Main + 2NO + 2NC 240V
	RIIGNXC-185-415V	Contact 185A 3P 3NO Main + 2NO + 2NC 415V
	RIIGNXC-225-240V	Contact 225A 3P 3NO Main + 2NO + 2NC 240V
	RIIGNXC-225-415V	Contact 225A 3P 3NO Main + 2NO + 2NC 415V
	RIIGNXC-265-240V	Contact 265A 3P 3NO Main + 2NO + 2NC AC/DC 240V
	RIIGNXC-265-415V	Contact 265A 3P 3NO Main + 2NO + 2NC AC/DC 415V
	RIIGNXC-330-240V	Contact 330A 3P 3NO Main + 2NO + 2NC AC/DC 240V
	RIIGNXC-330-415V	Contact 330A 3P 3NO Main + 2NO + 2NC AC/DC 415V
	RIIGNXC-400-240V	Contact 400A 3P 3NO Main + 2NO + 2NC AC/DC 240V
	RIIGNXC-400-415V	Contact 400A 3P 3NO Main + 2NO + 2NC AC/DC 415V
		RIIGNXC-500-240V
RIIGNXC-500-415V		Contact 500A 3P 3NO Main + 2NO + 2NC AC/DC 415V
RIIGNXC-630-240V		Contact 630A 3P 3NO Main + 2NO + 2NC AC/DC 240V
RIIGNXC-630-415V		Contact 630A 3P 3NO Main + 2NO + 2NC AC/DC 415V
		RIIG AX-3X/11
	RIIG AX-3X/02	Top Mount Aux Contact 2NC
	RIIG AX-3X/20	Top Mount Aux Contact 2NO
	RIIG AX-3X/22	Top Mount Aux Contact 2NO + 2NC
	RIIG AX-3X/13	Top Mount Aux Contact 1NO + 3NC
	RIIG AX-3X/31	Top Mount Aux Contact 3NO + 1NC
	RIIG AX-3X/04	Top Mount Aux Contact 4NC
	RIIG AX-3X/40	Top Mount Aux Contact 4NO
	RIIG AX-3C/11	Side Mount Aux Contact for NXC 6A-225A
	RIIG AX-3C/11B	Side Mount Aux Contact for NXC 265A-630A
	RIIGTIM-F5-D02	T/Mount Breaking Time Delay 0.1-30s

NEXT Series Contactors



Product Code	Item Description
RIIGTIM-F5-T02	T/Mount Making Time Delay 0.1-30s
RIIGTIM-F5-T04	T/Mount Making Time Delay 10-180s
RIIGMI-5	Mechanical Interlock for NXC-09-38
RIIGMI-6	Mechanical Interlock for NXC-40-65
RIIGMI-7	Mechanical Interlock for NXC-75-100
RIIGMI-9	Mechanical Interlock for NXC-120-225
RIIGNCL8-C	Mechanical Interlock for NXC-265-630



RIIGCO-NXC-06/22-024	Coil for NXC-06-22 24V
RIIGCO-NXC-06/22-036	Coil for NXC-06-22 36V
RIIGCO-NXC-06/22-048	Coil for NXC-06-22 48V
RIIGCO-NXC-06/22-110	Coil for NXC-06-22 110V
RIIGCO-NXC-06/22-240	Coil for NXC-06-22 240V
RIIGCO-NXC-06/22-415	Coil for NXC-06-22 415V



RIIGCO-NXC-25/38-24	Coil for NXC-25-38 24V
RIIGCO-NXC-25/38-36	Coil for NXC-25-38 36V
RIIGCO-NXC-25/38-48	Coil for NXC-25-38 48V
RIIGCO-NXC-25/38-110	Coil for NXC-25-38 110V
RIIGCO-NXC-25/38-240	Coil for NXC-25-38 240V
RIIGCO-NXC-25/38-415	Coil for NXC-25-38 415V



RIIGCO-NXC-40/65-24	Coil for NXC-40-65 24V
RIIGCO-NXC-40/65-36	Coil for NXC-40-65 36V
RIIGCO-NXC-40/65-48	Coil for NXC-40-65 48V
RIIGCO-NXC-40/65-110	Coil for NXC-40-65 110V
RIIGCO-NXC-40/65-240	Coil for NXC-40-65 240V
RIIGCO-NXC-40/65-415	Coil for NXC-40-65 415V



RIIGCO-NXC-75/100-24	Coil for NXC-75-100 24V
RIIGCO-NXC-75/100-36	Coil for NXC-75-100 36V
RIIGCO-NXC-75/100-48	Coil for NXC-75-100 48V
RIIGCO-NXC-75/100-110	Coil for NXC-75-100 110V
RIIGCO-NXC-75/100-240	Coil for NXC-75-100 240V
RIIGCO-NXC-75/100-415	Coil for NXC-75-100 415V

Contactor Accessories



Product Code	Item Description
RIIGCO-NXC-120/225-230	Coil For NXC-120-225 230V
RIIGCO-NXC-120/225-400	Coil For NXC-120-225 400V



RIIGCO-NXC-265/400-110	Coil For NXC-265-400 AC/DC 110V
RIIGCO-NXC-265/400-240	Coil For NXC-265-400 AC/DC 240V
RIIGCO-NXC-265/400-415	Coil For NXC-265-400 AC/DC 415V



RIIGCO-NXC-500/630-110	Coil For NXC-500-630 AC/DC 110V
RIIGCO-NXC-500/630-240	Coil For NXC-500-630 AC/DC 240V
RIIGCO-NXC-500/630-415	Coil For NXC-500-630 AC/DC 415V

NEXT Series Thermal Overload Relay

Thermal Overload Relays



Product Code	Item Description
RIIGNXR-12 1-1.6A	TOR 1-1.6A for NXC-06M/09M
RIIGNXR-12 1.6-2.5A	TOR 1.6-2.5A for NXC-06M/09M
RIIGNXR-12 2.5-4A	TOR 2.5-4A for NXC-06M/09M
RIIGNXR-12 4-6A	TOR 4-6A for NXC-06M/09M
RIIGNXR-12 5.5-8A	TOR 5.5-8A for NXC-06M/09M
RIIGNXR-12 7-10A	TOR 7-10A for NXC-06M/09M
RIIGNXR-12 9-12A	TOR 9-12A for NXC-06M/09M



RIIGNXR-25 0.25-0.4A	Thermal Overload Relay 0.25-0.4A
RIIGNXR-25 0.4-0.63A	Thermal Overload Relay 0.4-0.63A
RIIGNXR-25 0.63-1A	Thermal Overload Relay 0.63-1A
RIIGNXR-25 1-1.6A	Thermal Overload Relay 1-1.6A
RIIGNXR-25 1.6-2.5A	Thermal Overload Relay 1.6-2.5A
RIIGNXR-25 2.5-4A	Thermal Overload Relay 2.5-4A



STARTERS

Thermal Overload Relays

	Product Code	Item Description
	RIIGNXR-25 4-6A	Thermal Overload Relay 4-6A
	RIIGNXR-25 5.5-8A	Thermal Overload Relay 5-8A
	RIIGNXR-25 7-10A	Thermal Overload Relay 7-10A
	RIIGNXR-25 9-13A	Thermal Overload Relay 9-13A
	RIIGNXR-25 12-18A	Thermal Overload Relay 12-18A
	RIIGNXR-25 17-25A	Thermal Overload Relay 17-25A
	RIIGNXR-38 23-32A	Thermal Overload Relay 23-32A
	RIIGNXR-38 30-38A	Thermal Overload Relay 30-38A
	RIIGNXR-100 23-32A	Thermal Overload Relay 23-32A
	RIIGNXR-100 30-40A	Thermal Overload Relay 30-40A
	RIIGNXR-100 37-50A	Thermal Overload Relay 37-50A
	RIIGNXR-100 48-65A	Thermal Overload Relay 48-65A
	RIIGNXR-100 55-70A	Thermal Overload Relay 55-70A
	RIIGNXR-100 63-80A	Thermal Overload Relay 63-80A
	RIIGNXR-100 80-93A	Thermal Overload Relay 80-93A
	RIIGNXR-200 80-160A	Thermal Overload Relay 80-160A
	RIIGNXR-200 100-200A	Thermal Overload Relay 100-200A
	RIIGNXR-630 200-400A	Thermal Overload Relay 200-400A



Thermal Overload Relays Accessories

	Product Code	Item Description
	RIIGMB-1-NXR-12	Base Mounting Block for NXR-12
	RIIGMB-2-NXR-25	Base Mounting Block for NXR-25
	RIIGMB-3-NXR-38	Base Mounting Block for NXR-38
	RIIGMB-4-NXR-100	Base Mounting Block for NXR-100

MMS Starters



	Product Code	Item Description
	RIIGNS2-25 0.25-0.4A	Manual Motor Starter 0.25-0.4A
	RIIGNS2-25 0.4-0.63A	Manual Motor Starter 0.4-0.63A
	RIIGNS2-25 0.63-1A	Manual Motor Starter 0.63-1.0A
	RIIGNS2-25 1-1.6A	Manual Motor Starter 1.0-1.6A
	RIIGNS2-25 1.6-2.5A	Manual Motor Starter 1.6-2.5A
	RIIGNS2-25 2.5-4A	Manual Motor Starter 2.5-4A
	RIIGNS2-25 4-6.3A	Manual Motor Starter 4-6.3A
	RIIGNS2-25 6-10A	Manual Motor Starter 6-10A
	RIIGNS2-25 9-14A	Manual Motor Starter 9-14A
	RIIGNS2-25 13-18A	Manual Motor Starter 13-1A
	RIIGNS2-25 17-23A	Manual Motor Starter 17-23A
	RIIGNS2-25 20-25A	Manual Motor Starter 20-25A
	RIIGNS2-25 24-32A	Manual Motor Starter 24-32A
	RIIGNS2-80B 25-40A	Manual Motor Starter 25-40A
	RIIGNS2-80B 40-63A	Manual Motor Starter 40-63A
	RIIGNS2-80B 56-80A	Manual Motor Starter 56-80A

MMS Starters	Product Code	Item Description
 <p>NS2-25X</p>	RIIGNS2-25X 0.4-0.63A	Manual Motor Starter 0.4-0.63A
	RIIGNS2-25X 0.63-1A	Manual Motor Starter 0.63-1.0A
	RIIGNS2-25X 1-1.6A	Manual Motor Starter 1.0-1.6A
	RIIGNS2-25X 1.6-2.5A	Manual Motor Starter 1.6-2.5A
	RIIGNS2-25X 2.5-4A	Manual Motor Starter 2.5-4.0A
	RIIGNS2-25X 4-6.3A	Manual Motor Starter 4-6.3A
	RIIGNS2-25X 6-10A	Manual Motor Starter 6-10A
	RIIGNS2-25X 9-14A	Manual Motor Starter 9-14A
	RIIGNS2-25X 13-18A	Manual Motor Starter 13-18A
	RIIGNS2-25X 17-23A	Manual Motor Starter 17-23A
	RIIGNS2-25X 20-25A	Manual Motor Starter 20-25A
	RIIGNS2-32X 24-32A	Manual Motor Starter 24-32A
	RIIGNS2-80 30-40A	Manual Motor Starter 30-40A
	RIIGNS2-80 48-65A	Manual Motor Starter 48-65A
RIIGNS2-80 63-80A	Manual Motor Starter 63-80A	
 <p>NS2-80</p>	RIIGAUX-NS2-AE11	Front Mount Auxiliary Contact 1NO + 1NC
	RIIGAUX-NS2-AU20	Side Mount Auxiliary Contact 2NO
	RIIGAUX-NS2-25-AU11	Side Mount Auxiliary Contact for NS2-25
	RIIGAUX-NS2-80B-AU11	Side Mount Auxiliary Contact for NS2-80B
	RIIGAUX-NS2-80-AU11	Side Mount Auxiliary Contact for NS2-80
	RIIGNS2-MC	Surface Enclosure for Manual Motor Starter for NS2-25
	RIIGNQB1	Connection block between NS2 and NC1-09/18

DOL Starters	Product Code	Item Description
	RIIGNQ2-15P/1 0.63-1A 400V	DOL Starter Steel 0.63-1A 400V
	RIIGNQ2-15P/1 1-1.6A 400V	DOL Starter Steel 1.0-1.6A 400V
	RIIGNQ2-15P/1 1.6-2.5A 400V	DOL Starter Steel 1.6-2.5A 400V
	RIIGNQ2-15P/1 2.5-4A 400V	DOL Starter Steel 2.5-4A 400V
	RIIGNQ2-15P/1 2.5-4A 230V	DOL Starter Steel 2.5-4A 230V
	RIIGNQ2-15P/1 5.5-8A 400V	DOL Starter Steel 5.5-8A 400V
	RIIGNQ2-15P/1 7-10A 400V	DOL Starter Steel 7-10A 400V
	RIIGNQ2-15P/1 9-13A 400V	DOL Starter Steel 9-13A 400V
	RIIGNQ2-15P/1 12-18A 400V	DOL Starter Steel 12-18A 400V
	RIIGNQ2-15P/1 17-25A 400V	DOL Starter Steel 17-25A 400V
	RIIGNQ2-15P/1-230V	DOL Starter Steel NC1-1210 230V/No OL
	RIIGNQ2-15P/1-400V	DOL Starter Steel NC1-1210 400V/No OL
	RIIGNQ2-15P/2-230V	DOL Starter Steel NC1-1810 230V/No OL
	RIIGNQ2-15P/2-400V	DOL Starter Steel NC1-1810 400V/No OL
	RIIGNQ2-15P/3-230V	DOL Starter Steel NC1-2510 230V/No OL
	RIIGNQ2-15P/3-400V	DOL Starter Steel NC1-2510 400V/No OL
	RIIGNQ2-15P/4-230V	DOL Starter Steel NC1-3210 230V/No OL
	RIIGNQ2-15P/4-400V	DOL Starter Steel NC1-3210 400V/No OL



PUSH BUTTONS, PILOT LIGHTS & INDICATORS

DOL Starters	Product Code	Item Description
	RIIGNQ3-5.5P 1-1.6A 240V	DOL Starter Steel 0.63-1A 400V
	RIIGNQ3-5.5P 1-1.6A 400V	DOL Starter Steel 1.0-1.6A 400V
	RIIGNQ3-5.5P 1.6-2.5A 240V	DOL Starter Steel 1.6-2.5A 400V
	RIIGNQ3-5.5P 1.6-2.5A 400V	DOL Starter Steel 2.5-4A 400V
	RIIGNQ3-5.5P 2.5-4A 240V	DOL Starter Steel 2.5-4A 230V
	RIIGNQ3-5.5P 2.5-4A 400V	DOL Starter Steel 5.5-8A 400V
	RIIGNQ3-5.5P 4-6A 240V	DOL Starter Steel 7-10A 400V
	RIIGNQ3-5.5P 4-6A 400V	DOL Starter Steel 9-13A 400V
	RIIGNQ3-5.5P 5.5-8A 240V	DOL Starter Steel 12-18A 400V
	RIIGNQ3-5.5P 5.5-8A 400V	DOL Starter Steel 17-25A 400V
	RIIGNQ3-5.5P 7-10A 240V	DOL Starter Steel NC1-1210 230V/No OL
	RIIGNQ3-5.5P 7-10A 400V	DOL Starter Steel NC1-1210 400V/No OL
	RIIGNQ3-5.5P 9-13A 240V	DOL Starter Steel NC1-1810 230V/No OL
	RIIGNQ3-5.5P 9-13A 400V	DOL Starter Steel NC1-1810 400V/No OL
	RIIGNQ3-5.5P 240V	DOL Starter Steel NC1-2510 230V/No OL
	RIIGNQ3-5.5P 400V	DOL Starter Steel NC1-2510 400V/No OL
	RIIGNQ3-11P 240V	DOL Starter Steel NC1-3210 230V/No OL
	RIIGNQ3-11P 400V	DOL Starter Steel NC1-3210 400V/No OL

Indicators	Product Code	Item Description
	RIIGND9-1/G-230V	Single Indicator Light Green 230V
	RIIGND9-1/R-230V	Single Indicator Light Red 230V
	RIIGND9-1/GR-230V	Dual Indicator Light Green & Red 230V

Buzzers	Product Code	Item Description
	RIIGND16-22FS-24V R	Buzzer Red Ac/DC 24V
	RIIGND16-22FS-AC240R	Buzzer Red AC240V

Indicators	Product Code	Item Description
	RIIGND16-22BS-2-24B	LED Pilot Light 24V AC/DC Blue (Flat Round)
	RIIGND16-22BS-2-24R	LED Pilot Light 24V AC/DC Red (Flat Round)
	RIIGND16-22BS-2-24Y	LED Pilot Light 24V AC/DC Yellow (Flat Round)
	RIIGND16-22BS-2-24G	LED Pilot Light 24V AC/DC Green (Flat Round)
	RIIGND16-22BS-2-24O	LED Pilot Light 24V AC/DC Orange (Flat Round)
	RIIGND16-22BS-2-240Y	LED Pilot Light 24V AC/DC Yellow (Flat Round)
	RIIGND16-22BS-2-240W	LED Pilot Light 24V AC/DC White (Flat Round)
	RIIGND16-22BS-4-110O	LED Pilot Light 110VAC Orange (Flat Round)
	RIIGND16-22BS-4-110W	LED Pilot Light 110VAC White (Flat Round)
	RIIGND16-22BS-4-110B	LED Pilot Light 110VAC Blue (Flat Round)
	RIIGND16-22BS-4-110Y	LED Pilot Light 110VAC Yellow (Flat Round)
	RIIGND16-22BS-4-110G	LED Pilot Light 110VAC Green (Flat Round)
	RIIGND16-22BS/4-110R	LED Pilot Light 110VAC Red (Flat Round)
	RIIGND16-22BS/4-240B	LED Pilot Light 240VAC Blue (Flat Round)
	RIIGND16-22BS-4-240R	LED Pilot Light 240VAC Red (Flat Round)
	RIIGND16-22BS-4-240G	LED Pilot Light 240VAC Green (Flat Round)
	RIIGND16-22BS-4-240O	LED Pilot Light 240VAC Orange (Flat Round)
	RIIGND16-22BS-4-240Y	LED Pilot Light 240VAC Yellow (Flat Round)
	RIIGND16-22BS-4-240W	LED Pilot Light 240VAC White (Flat Round)
RIIGND16-22BS-4-400R	LED Pilot Light 400VAC Red (Flat Round)	
	RIIGND16-22CS-2-24B	LED Pilot Light 24V AC/DC Blue (Arc Surface)
	RIIGND16-22CS-2-24R	LED Pilot Light 24V AC/DC Red (Arc Surface)
	RIIGND16-22CS-2-24Y	LED Pilot Light 24V AC/DC Yellow (Arc Surface)
	RIIGND16-22CS-4-24G	LED Pilot Light 24V AC/DC Green (Arc Surface)
	RIIGND16-22CS-4-24OR	LED Pilot Light 24VAC Red (Arc Surface)
	RIIGND16-22CS-4-240G	LED Pilot Light 24VAC Green (Arc Surface)
	RIIGND16-22CS-4-240Y	LED Pilot Light 24VAC Yellow (Arc Surface)
	RIIGND16-22CS-4-240B	LED Pilot Light 24VAC Blue (Arc Surface)

Push Buttons (IP40)	Product Code	Item Description
	RIIGNP2-BZ31	Legend Plate and Holder
	RIIGNP2-BZ009	Metal Bezel for Pushbutton
	RIIGNP2-BE101	Contact Block NO
	RIIGNP2-BE102	Contact Block NC
	RIIGNP2-BZ101	Contact Block 1NO with Mounting Block
	RIIGNP2-BZ102	Contact Block 1NC with Mounting Block
	RIIGNP2-BZ103	Contact Block 2NO with Mounting Block
	RIIGNP2-BZ104	Contact Block 2NC with Mounting Block
	RIIGNP2-BA03	Metal Flush Pushbutton Head Green 22mm
	RIIGNP2-BA04	Metal Flush Pushbutton Head Red 22mm
	RIIGNP2-BA11	Metal Pushbutton Head White + 1NO Contact
	RIIGNP2-BA21	Metal Pushbutton Head Black + 1NO Contact
	RIIGNP2-BA31	Metal Pushbutton Head Green + 1NO Contact
	RIIGNP2-BA41	Metal Pushbutton Head Red + 1NO Contact
	RIIGNP2-BA42	Metal Pushbutton Head Red + 1NC Contact
	RIIGNP2-BA51	Metal Pushbutton Head Yellow + 1NO Contact
	RIIGNP2-BA61	Metal Pushbutton Head Blue + 1NO Contact
	RIIGNP2-BD02	Selector Switch Head 2 position
	RIIGNP2-BD03	Selector Switch Head 3 position
	RIIGNP2-BD23	Selector Switch 2P Complete 2NO
	RIIGNP2-BD33	3 Way Selector Switch Complete 2NO
	RIIGNP2-ED23	2 Way Selector Switch Stay Put 2NO PVC
	RIIGNP2-ED33	3 Way Selector Switch Stay Put 2NO PVC
	RIIGNP2-ED53	3 Way Selector Switch Way Spring Return 2NO PVC
	RIIGNP2-EG25	2 Way Key Switch 1NO + 1NC
	RIIGNP2-BG02	Key Selector Head 2 Position Stay Put
	RIIGNP2-BG04	Key Selector Head 2 Position Spring Return
	RIIGNP2-ES544	Emergency Stop Twist Release
	RIIGNP2-BS541	Emergency Stop Twist Release 1NO
	RIIGNP2-BS542	Emergency Stop Twist Release 1NC
	RIIGNP2-BS54	Metal Emergency Stop Twist to Release
	RIIGNP2-BL8325	Double Complete Button Flush
	RIIGNP2-BL8425	Metal Double Head Square Raised
	RIIGNP2-J01	Yellow Lid One Hole Enclosure 65 x 65
	RIIGNP2-J174	Emergency Stop 65 x 65 Yellow Enclosure
	RIIGNPH1-10J	Push Button Enclosure



VSD & SOFT STARTERS

Push Buttons (IP65)	Product Code	Item Description
	RIIGNP8-10BN/1	Pushbutton Non-illuminated White 1NO
	RIIGNP8-10BN/2	Pushbutton Non-illuminated Black 1NO
	RIIGNP8-10BN/3	Pushbutton Non-illuminated Green 1NO
	RIIGNP8-10BN/5	Pushbutton Non-illuminated Yellow 1NO
	RIIGNP8-10BN/6	Pushbutton Non-illuminated Blue 1NO
	RIIGNP8-01BN/4	Pushbutton Non-illuminated Red 1NC
	RIIGNP8-10BND/3	Pushbutton illuminated Green 1NO 110V-230VAC
	RIIGNP8-10BND/5	Pushbutton illuminated Yellow 1NO 110V-230VAC
	RIIGNP8-10BND/6	Pushbutton illuminated Blue 1NO 110V-230VAC
	RIIGNP8-01BND/4	Pushbutton illuminated Red 1NC 110V-230VAC
	RIIGNP8-01ZS/14	Emergency Stop Red 40mm Twist Release
	RIIGNP8-01ZS/24	Emergency Stop Red 60mm Twist Release
	RIIGNP8-115	Pushbutton Red & Green 1NO + 1NC
	RIIGNP8-10X/212	Selector Switch 2 Position Stay Put 1NO
	RIIGNP8-10X/222	Selector Switch 2 Position Spring Return 1NO
	RIIGNP8-20X/312	Selector Switch 3 Position Stay Put 2NO
	RIIGNP8-20X/332	Selector Switch 3 Position Spring Return 2NO
	RIIGNP8-CONTACT NO	Auxiliary Contact Block NO
	RIIGNP8-CONTACT NC	Auxiliary Contact Block NC
	RIIGNP8 BASE	Spare Base NP8
	RIIGBY9330	Yellow Emergency Label 22mm

VSD	Product Code	Item Description
	RIIGNVF3M-0.75/TS4	0.75KW Variable Speed Frive 380V
	RIIGNVF2G-1.5/TS4	1.5KW Variable Speed Frive 380V
	RIIGNVF2G-2.2/TS4	2.2KW Variable Speed Frive 380V
	RIIGNVF2G-3.7/TS4	3.7KW Variable Speed Frive 380V
	RIIGNVF2G-5.5/TS4	5.5KW Variable Speed Frive 380V
	RIIGNVF2G-7.5/TS4	7.5KW Variable Speed Frive 380V
	RIIGNVF2G-11/TS4	11KW Variable Speed Frive 380V
	RIIGNVF2G-15/TS4	15KW Variable Speed Frive 380V
	RIIGNVF2G-18/TS4	18.5KW Variable Speed Frive 380V
	RIIGNVF2G-22/TS4	22KW Variable Speed Frive 380V
	RIIGNVF2G-30/TS4	30KW Variable Speed Frive 380V
	RIIGNVF2G-37/TS4	37KW Variable Speed Frive 380V
	RIIGNVF2G-45/TS4	45KW Variable Speed Frive 380V
	RIIGNVF2G-55/TS4	55KW Variable Speed Frive 380V
	RIIGNVF2G-75/TS4	75KW Variable Speed Frive 380V
	RIIGNVF2G-90/TS4	90KW Variable Speed Frive 380V
	RIIGNVF2G-110/TS4	110KW Variable Speed Frive 380V
	RIIGNVF2G-132/TS4	132KW Variable Speed Frive 380V
	RIIGNVF2G-160/TS4	160KW Variable Speed Frive 380V
	RIIGNVF2G-200/TS4	200KW Variable Speed Frive 380V
RIIGEXT.CAB NVF2G(10M)	10m NVF2G Extension Cable & Support Plate	
RIIGEXT.CAB NVF2G(6M)	6m NVF2G Extension Cable & Support Plate	
RIIGEXT.CAB NVF2G(4M)	4m NVF2G Extension Cable & Support Plate	
RIIGEXT.CAB NVF2G(2M)	2m NVF2G Extension Cable & Support Plate	

Soft Starters	Product Code	Item Description
	RIIGNJR2-7.5D	7.5kW Soft Starter 380V
	RIIGNJR2-11D	11kW Soft Starter 380V
	RIIGNJR2-15D	15kW Soft Starter 380V
	RIIGNJR2-18.5D	18.5kW Soft Starter 380V
	RIIGNJR2-22D	22kW Soft Starter 380V
	RIIGNJR2-30D	30kW Soft Starter 380V
	RIIGNJR2-37D	37kW Soft Starter 380V
	RIIGNJR2-45D	45kW Soft Starter 380V
	RIIGNJR2-55D	55kW Soft Starter 380V
	RIIGNJR2-75D	75kW Soft Starter 380V
	RIIGNJR2-90D	90kW Soft Starter 380V
	RIIGNJR2-110D	110kW Soft Starter 380V
	RIIGNJR2-132D	132kW Soft Starter 380V



ISOLATORS

Large Frame Isolators	Product Code	Item Description
	RIIGNXHM-125/3-125A	3 Pole Large Frame Isolator 125A
	RIIGNXHM-160/3-160A	3 Pole Large Frame Isolator 160A
	RIIGNXHM-250/3-250A	3 Pole Large Frame Isolator 250A
	RIIGNXHM-400/3-400A	3 Pole Large Frame Isolator 400A
	RIIGNXHM-630/3-630A	3 Pole Large Frame Isolator 630A

Din Rail Isolaters



Product Code	Item Description
RIIGNH2-125-1P-32A	Isolator 1P 32A Din Rail
RIIGNH2-125-1P-63A	Isolator 1P 63A Din Rail
RIIGNH2-125-1P-100A	Isolator 1P 100A Din Rail
RIIGNH2-125-1P-125A	Isolator 1P 125A Din Rail
RIIGNH2-125-2P-32A	Isolator 2P 32A Din Rail
RIIGNH2-125-2P-63A	Isolator 2P 63A Din Rail
RIIGNH2-125-2P-100A	Isolator 2P 100A Din Rail
RIIGNH2-125-2P-125A	Isolator 2P 125A Din Rail



RIIGNH2-125-3P-32A	Isolator 3P 32A Din Rail
RIIGNH2-125-3P-63A	Isolator 3P 63A Din Rail
RIIGNH2-125-3P-100A	Isolator 3P 100A Din Rail
RIIGNH2-125-3P-125A	Isolator 3P 125A Din Rail
RIIGNH2-125-4P-32A	Isolator 4P 32A Din Rail
RIIGNH2-125-4P-63A	Isolator 4P 63A Din Rail
RIIGNH2-125-4P-100A	Isolator 4P 100A Din Rail
RIIGNH2-125-4P-125A	Isolator 4P 125A Din Rail

Weatherproof Isolaters



Product Code	Item Description
RIIGUKF2-20	Weatherproof Isolator 2P 20A/440V
RIIGUKF2-35	Weatherproof Isolator 2P 35A/440V
RIIGUKF2-63	Weatherproof Isolator 2P 63A/440V
RIIGUKF3-20	Weatherproof Isolator 3P 20A/440V
RIIGUKF3-35	Weatherproof Isolator 3P 35A/440V
RIIGUKF3-63	Weatherproof Isolator 3P 63A/440V
RIIGUKF4-35	Weatherproof Isolator 4P 35A/440V
RIIGUKF4-63	Weatherproof Isolator 3P 63A/440V

Rotary Isolaters



Product Code	Item Description
RIIGUKP-316	Rotary Isolator 3P 16A IP65
RIIGUKP-320	Rotary Isolator 3P 20A IP65
RIIGUKP-325	Rotary Isolator 3P 25A IP65
RIIGUKP-332	Rotary Isolator 3P 32A IP65
RIIGUKP-363	Rotary Isolator 3P 63A IP65
RIIGUKP-3100	Rotary Isolator 3P 100A IP65
RIIGUKP-420	Rotary Isolator 4P 20A IP65
RIIGUKP-432	Rotary Isolator 4P 32A IP65
RIIGUKP-463	Rotary Isolator 4P 63A IP65
RIIGUKP-4100	Rotary Isolator 4P 100A IP65

Isolator with Extension Handle



Product Code	Item Description
RIIGNH40-125/3W	125A 3P Isolator with Extension Handle
RIIGNH40-160/3W	160A 3P Isolator with Extension Handle
RIIGNH40-200/3W	200A 3P Isolator with Extension Handle
RIIGNH40-250/3W	250A 3P Isolator with Extension Handle
RIIGNH40-315/3W	315A 3P Isolator with Extension Handle
RIIGNH40-400/3W	400A 3P Isolator with Extension Handle
RIIGNH40-630/3W	630A 3P Isolator with Extension Handle
RIIGNH40-1000/3W	1000A 3P Isolator with Extension Handle
RIIGNH40-1250/3W	1250A 3P Isolator with Extension Handle
RIIGNH40-1600/3W	1600A 3P Isolator with Extension Handle

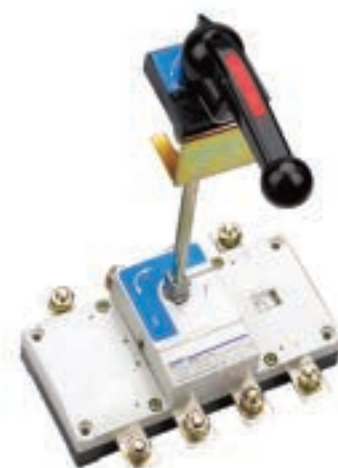



RIIGNH40-125/4W	125A 4P Isolator with Extension Handle
RIIGNH40-160/4W	160A 4P Isolator with Extension Handle
RIIGNH40-200/4W	200A 4P Isolator with Extension Handle
RIIGNH40-250/4W	250A 4P Isolator with Extension Handle
RIIGNH40-315/4W	315A 4P Isolator with Extension Handle
RIIGNH40-400/4W	400A 4P Isolator with Extension Handle
RIIGNH40-630/4W	630A 4P Isolator with Extension Handle
RIIGNH40-1000/4W	1000A 4P Isolator with Extension Handle
RIIGNH40-1250/4W	1250A 4P Isolator with Extension Handle
RIIGNH40-1600/4W	1600A 4P Isolator with Extension Handle







CHANGEOVER SWITCHES



Changeover Switches	Product Code	Item Description
	RIIGNXZB-63H/4C-63A	63A 4P Automatic Changeover Switch

Changeover Switches	Product Code	Item Description
	RIIGNXZ-125/4A 125A	125A 4P Automatic Changeover Switch
	RIIGNXZ-250/4A 160A	160A 4P Automatic Changeover Switch
	RIIGNXZ-250/4A 200A	200A 4P Automatic Changeover Switch
	RIIGNXZ-250/4A 250A	250A 4P Automatic Changeover Switch
	RIIGNXZ-630/4A315A	315A 4P Automatic Changeover Switch
	RIIGNXZ-630/4A400A	400A 4P Automatic Changeover Switch
	RIIGNXZ-630/4A500A	500A 4P Automatic Changeover Switch
	RIIGNXZ-630/4A630A	630A 4P Automatic Changeover Switch

	RIIGNH40-1000/4SZ	1000A 4P Automatic Changeover Switch
	RIIGNH40-1250/4SZ	1250A 4P Automatic Changeover Switch

Changeover Switches	Product Code	Item Description
	RIIGNH40-160/3CSW	160A 3P Changeover Switch with Extension Handle
	RIIGNH40-200/3CSW	200A 3P Changeover Switch with Extension Handle
	RIIGNH40-250/3CSW	250A 3P Changeover Switch with Extension Handle
	RIIGNH40-315/3CSW	315A 3P Changeover Switch with Extension Handle
	RIIGNH40-400/3CSW	400A 3P Changeover Switch with Extension Handle
	RIIGNH40-630/3CSW	630A 3P Changeover Switch with Extension Handle
	RIIGNH40-1000/3CSW	1000A 3P Changeover Switch with Extension Handle
	RIIGNH40-1250/3CSW	1250A 3P Changeover Switch with Extension Handle
	RIIGNH40-160/4CSW	160A 4P Changeover Switch with Extension Handle
	RIIGNH40-200/4CSW	200A 4P Changeover Switch with Extension Handle
	RIIGNH40-250/4CSW	250A 4P Changeover Switch with Extension Handle
	RIIGNH40-315/4CSW	315A 4P Changeover Switch with Extension Handle
	RIIGNH40-400/4CSW	400A 4P Changeover Switch with Extension Handle
	RIIGNH40-630/4CSW	630A 4P Changeover Switch with Extension Handle
	RIIGNH40-1000/4CSW	1000A 4P Changeover Switch with Extension Handle
	RIIGNH40-1250/4CSW	1250A 4P Changeover Switch with Extension Handle
	RIIGJN219G40A	Changeover Switch 40A 2P Din-Rail
	RIIGJN219G63A	Changeover Switch 63A 2P Din-Rail
	RIIGJN419G63A	Changeover Switch 63A 4P Din-Rail
	RIIGJN2125G63A	Changeover Switch 63A 2P Din-Rail Large Frame
		

RELAYS

Time Relays	Product Code	Item Description
	RIIGNTEB-10B-DELON	Time Delay On Timer 1-10 Sec AC230V
	RIIGNTEB-120B-DELON	Time Delay On Timer 12-120 Sec AC230V
	RIIGNTEB-480B-DELON	Time Delay On Timer 48-480 Sec AC230V
	RIIGNTEB-M1-DELON	Time Delay On Timer 1 Sec - 10 Day AC230V
	RIIGNTEB-10A-DELOFF	Time Delay Off Timer 1-10 Sec AC230V
	RIIGNTEB-120A-DELOFF	Time Delay Off Timer 12-120 Sec AC230V
	RIIGNTEB-480A-DELOFF	Time Delay Off Timer 48-480 Sec AC230V
	RIIGNTEB-Y AC230V	Star-Delta Relay 3s-30s AC230
	RIIGNTEB-Y AC380V	Star-Delta Relay 3s-30s AC230

Phase Failure Relays	Product Code	Item Description
	RIIGNJYB1-AC380V	Phase Failure Relay AC380V Din Rail (PF, PS)
	RIIGNJYB3-8-AC220V	Phase Failure Relay AC220V Din Rail (PF, PS, OV, UV)
	RIIGNJYB3-8-AC380V	Phase Failure Relay AC380V Din Rail (PF, PS, OV, UV)
	RIIGNJYB3-3-AC380V	Phase Failure Relay AC380V Din Rail (PF, PS, UV)
	RIIGXJ3-D-380V	Phase Failure Relay AC380V (PF, PS, OV, UV)

Power Relays



Product Code	Item Description
RIIGJZX-22FD-2Z-24V	Miniature Power Relay 8 Pin 24VAC + LED Indicator
RIIGJZX-22FD-2Z-110V	Miniature Power Relay 8 Pin 110VAC + LED Indicator
RIIGJZX-22FD-2Z-220V	Miniature Power Relay 8 Pin 220VAC + LED Indicator
RIIGJZX-22FD-2Z-12DC	Miniature Power Relay 8 Pin 12VDC + LED Indicator
RIIGJZX-22FD-2Z-24DC	Miniature Power Relay 8 Pin 24VDC + LED Indicator
RIIGJZX-22FD-3Z-24V	Miniature Power Relay 11 Pin 24VAC + LED Indicator
RIIGJZX-22FD-3Z-110V	Miniature Power Relay 11 Pin 110VAC + LED Indicator
RIIGJZX-22FD-3Z-220V	Miniature Power Relay 11 Pin 220VAC + LED Indicator
RIIGJZX-22FD-3Z-12DC	Miniature Power Relay 11 Pin 12VDC + LED Indicator
RIIGJZX-22FD-3Z-24DC	Miniature Power Relay 11 Pin 24VDC + LED Indicator
RIIGJZX-22FD-4Z-24V	Miniature Power Relay 14 Pin 24VAC + LED Indicator
RIIGJZX-22FD-4Z-110V	Miniature Power Relay 14 Pin 110VAC + LED Indicator
RIIGJZX-22FD-4Z-220V	Miniature Power Relay 14 Pin 220VAC + LED Indicator
RIIGJZX-22FD-4Z-24VDC	Miniature Power Relay 14 Pin 24VDC + LED Indicator
RIIGJQX-10F-2Z-12V	Miniature Power Relay 8 Pin 12VAC
RIIGJQX-10F-2Z-24V	Miniature Power Relay 8 Pin 24VAC
RIIGJQX-10F-2Z-110V	Miniature Power Relay 8 Pin 110VAC
RIIGJQX-10F-2Z-220V	Miniature Power Relay 8 Pin 220VAC
RIIGJQX-10F-2Z-12VDC	Miniature Power Relay 8 Pin 12VDC
RIIGJQX-10F-2Z-24VDC	Miniature Power Relay 8 Pin 24VDC
RIIGJQX-10F-3Z-12V	Miniature Power Relay 11 Pin 12VAC
RIIGJQX-10F-3Z-24V	Miniature Power Relay 11 Pin 24VAC
RIIGJQX-10F-3Z-110V	Miniature Power Relay 11 Pin 110VAC
RIIGJQX-10F-3Z-220V	Miniature Power Relay 11 Pin 220VAC
RIIGJQX-10F-3Z-380V	Miniature Power Relay 11 Pin 380VAC
RIIGJQX-10F-3Z-12VDC	Miniature Power Relay 11 Pin 12VDC
RIIGJQX-10F-3Z-24VDC	Miniature Power Relay 11 Pin 24VDC
RIIGJQX-10F-3Z-220VDC	Miniature Power Relay 11 Pin 220VDC

Voltage Protection Relays	Product Code	Item Description
	RIIGOUVR-1/80A-1P + N-BE	Over Under Voltage Relay 80A 1P + N Bottom Entry
	RIIGOUVR-1/80A-3P + N-BE	Over Under Voltage Relay 80A 3P + N Bottom Entry

Accessories	Product Code	Item Description
	RIIGRB-CZY08A-E	8 Pin Flat Power Relay Base Finger Protection
	RIIGRB-CZY08B-01	8 Pin Flat Power Relay Base
	RIIGRB-CZY11B	11 Pin Flat Power Relay Base
	RIIGRB-CZY14B	14 Pin Flat Power Relay Base
	RIIGRB-CZY14B-E	14 Pin Flat Power Relay Base Finger Protection
	RIIGRB-CZF08A	8 Pin Round Power Relay Base
	RIIGRB-CZF11A	11 Pin Round Power Relay Base
	RIIGRB-CZS08C	8 Pin Round Time Relay Base



CURRENT TRANSFORMERS

CT	Product Code	Item Description
	RIIGCTI-30-50/5A	30mm Current Transformer 50/5A
	RIIGCTI-30-60/5A	30mm Current Transformer 60/5A
	RIIGCTI-30-75/5A	30mm Current Transformer 75/5A
	RIIGCTI-30-100/5A	30mm Current Transformer 100/5A
	RIIGCTI-30-150/5A	30mm Current Transformer 150/5A
	RIIGCTI-30-200/5A	30mm Current Transformer 200/5A
	RIIGCTI-30-250/5A	30mm Current Transformer 250/5A
	RIIGCTI-40-300/5A	40mm Current Transformer 300/5A
	RIIGCTI-50-300/5A	50mm Current Transformer 400/5A
	RIIGCTI-50-500/5A	50mm Current Transformer 500/5A
	RIIGCTI-50-600/5A	50mm Current Transformer 600/5A
	RIIGCTI-80-800/5A	80mm Current Transformer 800/5A
	RIIGCTI-80-1000/5A	80mm Current Transformer 1000/5A
	RIIGCTI-80-1500/5A	80mm Current Transformer 1500/5A
	RIIGCTI-100-1000/5A	100mm Current Transformer 1000/5A
	RIIGCTI-100-1500/5A	100mm Current Transformer 1500/5A
	RIIGCTI-120-2500/5A	120mm Current Transformer 2500/5A
	RIIGCTI-120-3000/5A	120mm Current Transformer 3000/5A



VOLTAGE TRANSFORMERS

VT	Product Code	Item Description
----	--------------	------------------



	RIIGNDK-200VA-24V	Primary 440V + 230V Secondary 24V Output
	RIIGNDK-200VA-36V	Primary 440V + 230V Secondary 36V Output
	RIIGNDK-200VA-110V	Primary 440V + 230V Secondary 110V Output
	RIIGNDK-200VA-220V	Primary 440V + 230V Secondary 220V Output
	RIIGNDK-300VA-12V	Primary 440V + 230V Secondary 12V Output
	RIIGNDK-300VA-24V	Primary 440V + 230V Secondary 24V Output
	RIIGNDK-300VA-36V	Primary 440V + 230V Secondary 36V Output
	RIIGNDK-300VA-110V	Primary 440V + 230V Secondary 110V Output
	RIIGNDK-300VA-220V	Primary 440V + 230V Secondary 220V Output
	RIIGNDK-500VA-12V	Primary 440V + 230V Secondary 12V Output
	RIIGNDK-500VA-24V	Primary 440V + 230V Secondary 24V Output
	RIIGNDK-500VA-36V	Primary 440V + 230V Secondary 36V Output
	RIIGNDK-500VA-110V	Primary 440V + 230V Secondary 110V Output
	RIIGNDK-500VA-220V	Primary 440V + 230V Secondary 220V Output
	RIIGNDK-1000VA-12V	Primary 440V + 230V Secondary 12V Output
	RIIGNDK-1000VA-24V	Primary 440V + 230V Secondary 24V Output
	RIIGNDK-1000VA-36V	Primary 440V + 230V Secondary 36V Output
	RIIGNDK-1000VA-110V	Primary 440V + 230V Secondary 110V Output
	RIIGNDK-1000VA-220V	Primary 440V + 230V Secondary 220V Output

VT	Product Code	Item Description
----	--------------	------------------



	RIIGNDK-25VA-230/24V	Primary 230V Secondary 24V Output
	RIIGNDK-50VA-12V	Primary 440V + 230V Secondary 12V Output
	RIIGNDK-50VA-230/24V	Primary 230V Secondary 24V Output
	RIIGNDK-50VA-24V	Primary 440V + 230V Secondary 24V Output
	RIIGNDK-50VA-36V	Primary 440V + 230V Secondary 36V Output
	RIIGNDK-50VA-110V	Primary 440V + 230V Secondary 110V Output
	RIIGNDK-50VA-220V	Primary 440V + 230V Secondary 220V Output
	RIIGNDK-100VA-12V	Primary 440V + 230V Secondary 12V Output
	RIIGNDK-100VA-24V	Primary 440V + 230V Secondary 24V Output
	RIIGNDK-100VA-36V	Primary 440V + 230V Secondary 36V Output
	RIIGNDK-100VA-110V	Primary 440V + 230V Secondary 110V Output
	RIIGNDK-100VA-220V	Primary 440V + 230V Secondary 220V Output
	RIIGNDK-150VA-12V	Primary 440V + 230V Secondary 12V Output
	RIIGNDK-150VA-24V	Primary 440V + 230V Secondary 24V Output
	RIIGNDK-150VA-36V	Primary 440V + 230V Secondary 36V Output
	RIIGNDK-150VA-48V	Primary 440V + 230V Secondary 48V Output
	RIIGNDK-150VA-110V	Primary 440V + 230V Secondary 110V Output
	RIIGNDK-150VA-220V	Primary 440V + 230V Secondary 220V Output
	RIIGNDK-200VA-12V	Primary 440V + 230V Secondary 12V Output

TRAVEL SWITCHES

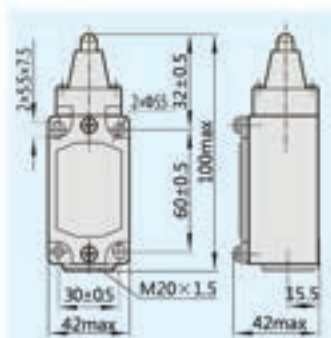

YBLX-K3 Dimensions



RIIGYBLX-K3/20S-Z

Travel Switch Plunger Type



RIIGYBLX-K3/20S-L

Travel Switch Plunger with Roller Type



RIIGYBLX-K3/20S-J

Travel Switch Adjust Metal Rocker Type



RIIGYBLX-K3/20S-D

Travel Switch Flexible Rocket Type



RIIGYBLX-K3/20S-B

Travel Switch Rotating Arm with Roller



RIIGYBLX-K3/20S-T

Travel Switch Adjust Rotating Arm



RIIGYBLX-K3/20S-H

Travel Switch Fork Type 2 Rollers

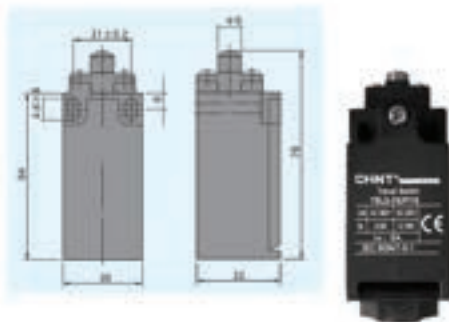

RIIGYBLX-CK-P110

Travel Switch YBLX-CK/P110

TRAVEL SWITCHES



RIIGYBLX-ME/8104

Travel Switch Roller Rotating Arm



RIIGYBLX-ME/8107

Travel Switch Adjustable Rotating Rod

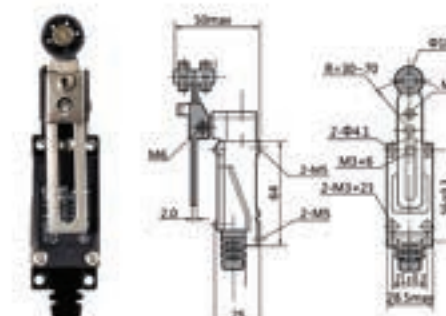

RIIGYBLX-ME/8108

Travel Switch Adjustable Roller Rotating Rod



RIIGYBLX-ME/8111

Travel Switch Direct Pressure Plunger



RIIGYBLX-ME/8112

Travel Switch Direct Pressure Plunger HR



RIIGYBLX-ME/8122

Travel Switch Direct Pressure Plunger VR



RIIGYBLX-ME/8166

Travel Switch Universal Type Plastic Tip



RIIGYBLX-ME/8169

Travel Switch Universal Type Plastic Tip



RIIGYBLX-CK-P110

Travel Switch Universal Coiled Spring

TRAVEL SWITCHES



RIIGYBLXW-5/11N2
Micro Switch 5/11N2



RIIGYBLXW-5/11Z
Micro Switch 5/11Z



RIIGYBLXW-5/11D1
Micro Switch 5/11D1



RIIGYBLXW-5/11N1
Micro Switch 5/11N1



RIIGYBLXW-5/11G2
Micro Switch 5/11G2



RIIGYBLXW-5/11G3
Micro Switch 5/11G3



RIIGYBLXW-5/11Q1
Micro Switch 5/11Q1



RIIGYBLXW-5/11Q2
Micro Switch 5/11Q2



RIIGYBLXW-5/11M
Micro Switch 5/11M



FLOAT SWITCHES

Float Switches



Product Code

RIIGFS-2-5M

RIIGFS-2-10M

Item Description

Float Switch 5 Meter

Float Switch 10 Meter

TERMINALS

Terminals



Product Code

RIIGJCUK-5JD

RIIGJCUK-6JD

RIIGJCUK-10JD

RIIGJCUK-16JD

RIIGJCUK-35JD

Item Description



Earth Connection Terminal 5mm

Earth Connection Terminal 6mm

Earth Connection Terminal 10mm



Earth Connection Terminal 16mm

Earth Connection Terminal 35mm

Terminals	Product Code	Item Description
	RIIGJXB-4/1	Connection Terminal 4/1
	RIIGJXB-10/1	Connection Terminal 10/1
	RIIGJXB-2.5/1	Connection Terminal 2.5/1
	RIIGJXB-6/1	Connection Terminal 6/1
	RIIGJXB-16/1	Connection Terminal 16/1
	RIIGJXB-35/1	Connection Terminal 35/1
	RIIGJXB-70/1	Connection Terminal 70/1
	RIIGAB-2.5-JXB	JXB Barrier 2.5mm
	RIIGAB-4-10-JXB	JXB Barrier 4-10mm
	RIIGAB-16-JXB	JXB Barrier 16mm
	RIIGAB-35-JXB	JXB Barrier 35mm
	RIIGAB-70-JXB	JXB Barrier 70mm
	RIIGEW35	Din End Stop for JXB (EW35)
	RIIGTB-1503	Terminal Block 3 Way 15A
	RIIGTB-1506	Terminal Block 6 Way 15A
	RIIGTB-2503	Terminal Block 3 Way 25A
	RIIGTB-2506	Terminal Block 6 Way 25A
	RIIGTB-2512	Terminal Block 12 Way 25A
	RIIGTB-6003	Terminal Block 3 Way 60A
	RIIGTB-10003	Terminal Block 3 Way 100A
	RIIGTC-1503	Terminal Block 3 Way 150A
	RIIGTC-2003	Terminal Block 3 Way 200A
	RIIGTC-3003	Terminal Block 3 Way 300A



FUSES

Fuses	Product Code	Item Description
	RIIGRT28-32-02A	Fuse 2A Ac380/500V gG/gL
	RIIGRT28-32-04A	Fuse 4A Ac380/500V gG/gL
	RIIGRT28-32-06A	Fuse 6A Ac380/500V gG/gL
	RIIGRT28-32-10A	Fuse 10A Ac380/500V gG/gL
	RIIGRT28-32-16A	Fuse 16A Ac380/500V gG/gL
	RIIGRT28-32-20A	Fuse 20A Ac380/500V gG/gL
	RIIGRT28-32-25A	Fuse 25A Ac380/500V gG/gL
	RIIGRT28-32-32A	Fuse 32A Ac380/500V gG/gL
	FUSE-HOLDER-1P	Fuse Holder 1 Pole For RIIGRT28-32
	FUSE-HOLDER-2P	Fuse Holder 2 Pole For RIIGRT28-32
FUSE-HOLDER-3P	Fuse Holder 3 Pole For RIIGRT28-32	
	RIIGRT36-1-200A	Fuse 200A AC500V/DC440V gG/gL
	RIIGRT36-1-250A	Fuse 250A AC500V/DC440V gG/gL
	FUSE BASE-RIIGRT36-1	Fuse Base For RIIGRT36-1

METERS









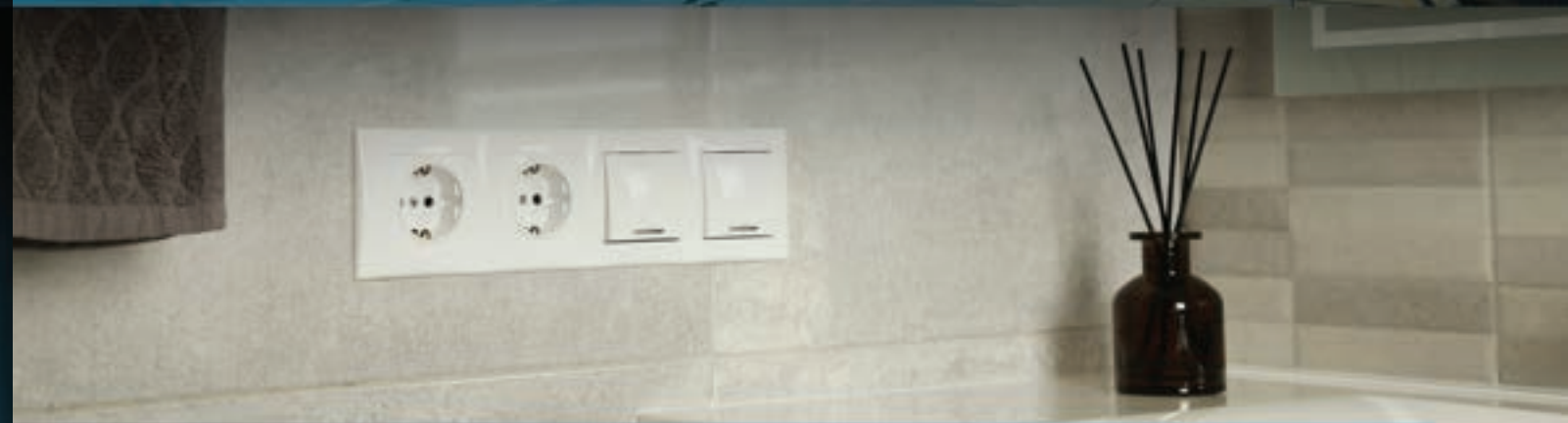

Voltage Protection Relays	Product Code	Item Description
	RIIGDSU666 1P 5(80)A	Single Phase Din-Rail Meter 5(80)A 230V
	RIIGDSU666 3P 5(80)A	Three Phase Four Wire Meter 5(80)A 3 x 230/400V
	RIIGDSU666 3P 1.5(6)A	Three Phase Four Wire Meter 1.5(6)A 3 x 230/400V

			
RIIGZTY0123A	RIIGZTY0125A	RIIGZTY0225A	RIIGN266
Digital Multi-Meter	Industrial Digital Multi-Meter	Digital Clamp Meter AC/DC800V	Digital Clamp Meter AC750V/DC1000V

SWITCHES & SOCKETS



Switches & Sockets	Product Code	Item Description
	RIIGNEW3-N00100	1 Lever 1 Way Switch 16A 2 x 4
	RIIGNEW3-N00200	1 Lever 2 Way Switch 16A 2 x 4
	RIIGNEW3-N00300	2 Lever 1 Way Switch 16A 2 x 4
	RIIGNEW3-N00400	2 Lever 2 Way Switch 16A 2 x 4
	RIIGNEW3-N00500	3 Lever 1 Way Switch 16A 2 x 4
	RIIGNEW3-N00700	4 Lever 1 Way Switch 16A 2 x 4
	RIIGNEW3-N00900	5 Lever 1 Way Switch 16A 4 x 4
	RIIGNEW3-N001100	6 Lever 1 Way Switch 16A 4 x 4
	RIIGNEW3-N42940	Single Switched Socket 16A 2 x 4
	RIIGNEW3-N42950	Single Switched Socket 16A 4 x 4
	RIIGNEW3-N44230	Double Switched Socket 16A 4 x 4
	RIIGNEW3-N44330	SA/Euro Combined Switched Socket 16A/10A
	RIIGNEW3-N00190	Isolator 45A Double Pole 4 x 4
	RIIGNEW3-N00160	Isolator 32A Double Pole 2 x 4
	RIIGNEW3-N44340	Single Switched Socket 16A, 2 x USB 2100mA
	RIIGNEW3-N44140	SA/Euro Combined Switched Socket 16A 2 x 4
	RIIGNEW3-N44150	SA/Euro Switched Socket 16A 4 x 4
	RIIGNEW3-N11800	Six Way Euro Socket 16A 4 x 4
	RIIGNEW3-N45110	Rotary Dimmer 1 Level 1 Way Switch 2 x 4
	RIIGNEW3-N30550	Rotary Dimmer 2 x 4
	RIIGNEW3-N95100	Blank Plate 2 x 4
	RIIGNEW3-N95110	Blank Plate 4 x 4

Switches & Sockets	Product Code	Item Description
	RIIGK1-CN-K001	1 Lever 1 Way Switch 2 x 4
	RIIGK1-CN-K002	2 Lever 1 Way Switch 2 x 4
	RIIGK1-CN-K003	3 Lever 1 Way Switch 2 x 4
	RIIGK1-CN-K004	4 Lever 1 Way Switch 2 x 4
	RIIGK1-CN-K005	5 Lever 1 Way Switch 4 x 4
	RIIGK1-CN-K006	6 Lever 1 Way Switch 4 x 4
	RIIGK1-CN-K010	1 Lever 2 Way Switch 2 x 4
	RIIGK1-CN-K011	2 Lever 2 Way Switch 2 x 4
	RIIGK1-CN-K020	Single Switched Socket 16A 2 x 4
	RIIGK1-CN-K021	Single Switched Socket 16A 4 x 4
	RIIGK1-CN-K022	Double Switched Socket 16A 4 x 4
	RIIGK1-CN-K025	Switched Socket 16A + 10A + 2 USB
	RIIGK1-CN-K026	Isolator 45A 2P 4 x 4
	RIIGK1-CN-K030	Dimmer 500W 2 x 4
	RIIGK1-CN-K031	1 Lever Switch + Dimmer 2 x 4
	RIIGK1-CN-K032	2 Lever Switch + Dimmer 2 x 4
	RIIGK1-CN-K034	SA/Euro Combined Switched Socket 16A
	RIIGK1-CN-K036	Blank Plate White 2 x 4
	RIIGK1-CN-K037	Blank Plate White 4 x 4

Extensions	Product Code	Item Description
	RIIGTT-F01-3M	Multi Socket Outlet with Cord Extension White - 3M
	RIIGTT-F01-5M	Multi Socket Outlet with Cord Extension White - 5M
	RIIGTT-F01-10M	Multi Socket Outlet with Cord Extension White - 10M
	RIIGTT-F01-15M	Multi Socket Outlet with Cord Extension White - 15M
	RIIGTT-F01-20M	Multi Socket Outlet with Cord Extension White - 20M
	RIIGTT-F03-3M	Multi Socket Outlet with Cord Extension Black - 3M
	RIIGTT-F03-5M	Multi Socket Outlet with Cord Extension Black - 5M
	RIIGTT-F03-10M	Multi Socket Outlet with Cord Extension Black - 10M
	RIIGTT-F03-15M	Multi Socket Outlet with Cord Extension Black - 15M
	RIIGTT-F03-20M	Multi Socket Outlet with Cord Extension Black - 20M

Multiplug Sockets		
		
RIIGTT-F02-03 16A Switched Multiplug 3 x 16A Black	RIIGTT-F02-05 16A Switched Multiplug 5 x 16A Black	RIIGTT-F02-06 16A Switched Multiplug 3 x 16A 5 x Euro Black
		
RIIGTT-F02-10 16A Switched Multiplug 5 x 16A 5 x Euro Black	RIIGTT-F02-09U 16A Switched Multiplug 4 x 16A 4 x Euro 1 x Schuko 2 x 5V 2.1A USB Black	RIIGTT-F02-09E 16A Switched Multiplug 4 x 16A 4 x Euro 1 x Schuko Black
		
RIIGTT-F02-07 16A Switched Multiplug 3 x 16A 3 x Euro 1 x Schuko White	RIIGTT-F02-09 16A Switched Multiplug 4 x 16A 4 x Euro 1 x Schuko White	RIIGTT-F02-11 16A Switched Multiplug 5 x 16A 5 x Euro 1 x Schuko White
		
RIIGTT-F02-07K 16A 4 x Switched Multiplug 3 x 16A 3 x Euro 1 x Schuko White	RIIGTT-F02-09K 16A 5 x Switched Multiplug 4 x 16A 4 x Euro 1 x Schuko White	RIIGTT-F02-011K 16A 6 x Switched Multiplug 5 x 16A 5 x Euro 1 x Schuko White







DISTRIBUTION BOXES & ENCLOSURES

Multiplug Adapters

			
RIIGTT-F03-A005	RIIGTT-F03-A013	RIIGTT-F03-004	RIIGTT-F03-A015
16A Adapter Schuko White	16A Adapter 1 x Schuko 1 x Euro	16A Adapter 3 x Euro White	16A Adapter 3 x 5A Euro 1 x Schuko
			
RIIGTT-F03-014	RIIGTT-F03-010	RIIGTT-F03-A112	RIIGTT-F03-A015
16A Adapter 3 x 16A	16A Adapter 3 x 16A 3 x Euro	16A Adapter 1 x 16A 1 x Schuko 1 x Euro 2 x 5V 2.1A USB	16A Adapter 3 x 16A 3 x Euro 2 x 5V 2.1A USB

Plug Tops & Couplers



			
RIIGTT-F03-A016	RIIGTT-F03-A017	RIIGTT-F03-006	RIIGTT-F03-A003
16A Plug Top White Plastic	16A Plug Top White (with Handle) Plastic	16A Plug Top Black Rubber	16A Double Coupler Janus White
			
RIIGTT-F03-A020			
16A Double Coupler Janus Black Rubber			

DB & Enclosures

Product Code



Item Description





	RIIGDB1-4S	4W Surface Empty Plastic DB
	RIIGDB1-6S	6W Surface Empty Plastic DB
	RIIGDB1-8S	8W Surface Empty Plastic DB
	RIIGDB1-12S	12W Surface Empty Plastic DB
	RIIGDB1-18S	18W Surface Empty Plastic DB
	RIIGDB1-4FP	4W Flush Empty Plastic DB
	RIIGDB1-6FP	6W Flush Empty Plastic DB
	RIIGDB1-8FP	8W Flush Empty Plastic DB
	RIIGDB1-12FP	12W Flush Empty Plastic DB
	RIIGDB1-18FP	18W Flush Empty Plastic DB
	RIIGDB1-4F	4W Flush Empty Steel DB
	RIIGDB1-6F	6W Flush Empty Steel DB
	RIIGDB1-8F	8W Flush Empty Steel DB
	RIIGDB1-12F	12W Flush Empty Steel DB
	RIIGDB1-18F	18W Flush Empty Steel DB

DB & Enclosures	Product Code	Item Description
	RIIGDB1(W)-8SK	8W Populated Surface DB (Plastic Tray DB with 1PCS 2P E/L 63A, 1PCS EBC 2P 63A, 2 PCS EBC 1P 20A and 1PCS EBC 1P 10A)
	RIIGDB1(W)-12SK	12W Populated Surface DB (Plastic Tray DB with 1PCS 2P E/L 63A, 1 PCS EBC 2P 63A, 1PCS EBC 1P 32A, 3PCS EBC 1P 20A and 2PCS EBC 1P 10A)
	RIIGDB1W-18SK	18W Populated Surface DB (Plastic Tray DB with 1PCS 2P E/L 63A, 1PCS EBC 2P 63A, 1PCS EBC 1P 32A, 4PCS EBC 1P 20A, 2PCS EBC 1P 10A)
	RIIGDB1(W)-8FK	8W Populated Flush DB (Steel Tray DB with 1PCS 2P E/L 63A, 1PCS EBC 2P 63A, 2PCS EBC 1P 20A, 1PCS EBC 1P 10A)
	RIIGDB1(W)-12FK	12W Populated Flush DB (Steel DB with 1PCS 2P E/L 63A, 1PCS EBC 2P 63A, 1PCS EBC 1P 32A, 3PCS EBC 1P 20A and 2PCS EBC 1P 10A)
	RIIGDB1(W)-18FK	18W Populated Flush DB (Steel DB with 1PCS 2P E/L 63A, 1PCS EBC 2P 63A, 1PCS EBC 1P 32A, 4PCS EBC 1P 20A and 2PCS EBC 1P 10A)
	RIIGDB1(W)-12FPK	12W Populated Flush DB (Plastic Tray DB with 1PCS 2P E/L 63A, 1PCS EBC 2P 63A, 1PCS EBC 1P 32A, 3PCS EBC 1P 20A and 2PCS EBC 1P 10A)

DB & Enclosures	Product Code	Item Description
	RIIGDB-SH4PN	Waterproof DB IP66 4 Way
	RIIGDB-SH6PN	Waterproof DB IP66 6 Way
	RIIGDB-SH9PN	Waterproof DB IP66 9 Way
	RIIGDB-SH12PN	Waterproof DB IP66 12 Way
	RIIGDB-SH18PN	Waterproof DB IP66 18 Way
	RIIGDB-SH24PN	Waterproof DB IP66 24 Way
	RIIGDB-SH36PN	Waterproof DB IP66 36 Way
	RIIGGWS-80/40	Weatherproof Box 80 x 40mm (With Knockouts)
	RIIGGWS-80/80/40	Weatherproof Box 80 x 80 x 40mm (With Knockouts)
	RIIGGWS-100/100/50	Weatherproof Box 100 x 100 x 50mm (With Knockouts)
	RIIGGWS-150/110/70	Weatherproof Box 150 x 110 x 70mm (With Knockouts)
	RIIGGWS-240/190/90	Weatherproof Box 240 x 190 x 90mm (With Knockouts)
	RIIGJB-80/80/40	Weatherproof Box 80 x 80 x 40mm
	RIIGJB-110/110/60	Weatherproof Box 110 x 110 x 60mm
	RIIGJB-155/115/110	Weatherproof Box 155 x 115 x 110mm
	RIIGJB-215/150/110	Weatherproof Box 215 x 150 x 110mm
	RIIGJB-255/200/160	Weatherproof Box 255 x 200 x 160mm
	RIIGJB-310/230/145	Weatherproof Box 310 x 230 x 145mm

PHOTOVOLTAIC DEVICES

PV DC Circuit Breakers	Product Code	Item Description
	RIIGEx9BP-JX 1P K10	PV DC Circuit Breaker 10A 1P 250V
	RIIGEx9BP-JX 1P K16	PV DC Circuit Breaker 16A 1P 250V
	RIIGEx9BP-JX 1P K20	PV DC Circuit Breaker 20A 1P 250V
	RIIGEx9BP-JX 1P K25	PV DC Circuit Breaker 25A 1P 250V
	RIIGEx9BP-JX 1P K32	PV DC Circuit Breaker 32A 1P 250V
	RIIGEx9BP-JX 1P K40	PV DC Circuit Breaker 40A 1P 250V
	RIIGEx9BP-JX 1P K50	PV DC Circuit Breaker 50A 1P 250V
	RIIGEx9BP-JX 1P K63	PV DC Circuit Breaker 63A 1P 250V
		RIIGEx9BP-JX 2P K10
RIIGEx9BP-JX 2P K16		PV DC Circuit Breaker 16A 2P 500V
RIIGEx9BP-JX 2P K20		PV DC Circuit Breaker 20A 2P 500V
RIIGEx9BP-JX 2P K25		PV DC Circuit Breaker 25A 2P 500V
RIIGEx9BP-JX 2P K32		PV DC Circuit Breaker 32A 2P 500V
RIIGEx9BP-JX 2P K40		PV DC Circuit Breaker 40A 2P 500V
RIIGEx9BP-JX 2P K50		PV DC Circuit Breaker 50A 2P 500V
RIIGEx9BP-JX 2P K63		PV DC Circuit Breaker 63A 2P 500V
		RIIGEx9BP-JX 4P K16
	RIIGEx9BP-JX 4P K20	PV DC Circuit Breaker 20A 4P 1000V
	RIIGEx9BP-JX 4P K25	PV DC Circuit Breaker 25A 4P 1000V
	RIIGEx9BP-JX 4P K32	PV DC Circuit Breaker 32A 4P 1000V
	RIIGEx9BP-JX 4P K40	PV DC Circuit Breaker 40A 4P 1000V
	RIIGEx9BP-JX 4P K50	PV DC Circuit Breaker 50A 4P 1000V
	RIIGEx9BP-JX 4P K63	PV DC Circuit Breaker 63A 4P 1000V

PV DC Circuit Breakers	Product Code	Item Description
	RIIGNB1-63DC-1P-C10	PV DC Circuit Breaker 10A 1P DC250V
	RIIGNB1-63DC-1P-C16	PV DC Circuit Breaker 16A 1P DC250V
	RIIGNB1-63DC-1P-C20	PV DC Circuit Breaker 20A 1P DC250V
	RIIGNB1-63DC-1P-C25	PV DC Circuit Breaker 25A 1P DC250V
	RIIGNB1-63DC-1P-C32	PV DC Circuit Breaker 32A 1P DC250V
	RIIGNB1-63DC-1P-C40	PV DC Circuit Breaker 40A 1P DC250V
	RIIGNB1-63DC-1P-C50	PV DC Circuit Breaker 50A 1P DC250V
	RIIGNB1-63DC-1P-C63	PV DC Circuit Breaker 63A 1P DC250V
	RIIGNB1-63DC-2P-C10	PV DC Circuit Breaker 10A 2P DC500V
	RIIGNB1-63DC-2P-C16	PV DC Circuit Breaker 16A 2P DC500V
	RIIGNB1-63DC-2P-C20	PV DC Circuit Breaker 20A 2P DC500V
	RIIGNB1-63DC-2P-C25	PV DC Circuit Breaker 25A 2P DC500V
	RIIGNB1-63DC-2P-C32	PV DC Circuit Breaker 32A 2P DC500V
	RIIGNB1-63DC-2P-C40	PV DC Circuit Breaker 40A 2P DC500V
	RIIGNB1-63DC-2P-C50	PV DC Circuit Breaker 50A 2P DC500V
	RIIGNB1-63DC-2P-C63	PV DC Circuit Breaker 63A 2P DC500V
	RIIGNB1-63DC-4P-C10	PV DC Circuit Breaker 10A 4P DC1000V
	RIIGNB1-63DC-4P-C16	PV DC Circuit Breaker 16A 4P DC1000V
	RIIGNB1-63DC-4P-C20	PV DC Circuit Breaker 20A 4P DC1000V
	RIIGNB1-63DC-4P-C25	PV DC Circuit Breaker 25A 4P DC1000V
	RIIGNB1-63DC-4P-C32	PV DC Circuit Breaker 32A 4P DC1000V
	RIIGNB1-63DC-4P-C40	PV DC Circuit Breaker 40A 4P DC1000V
	RIIGNB1-63DC-4P-C50	PV DC Circuit Breaker 50A 4P DC1000V
	RIIGNB1-63DC-4P-C63	PV DC Circuit Breaker 63A 4P DC1000V
		RIIGEx9UEP 20 2P 600
RIIGEx9UEP 20 2P 1000		PV DC Surge Arrestor 20KA 2P 1000V
RIIGEx9UEP 20 3P 1500		PV DC Surge Arrestor 20KA 3P 1500V

Connection diagram:



RIIGEx9UEP 20 2P 600



RIIGEx9UEP 20 2P 1000

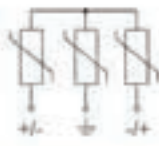



RIIGEx9UEP 20 3P 1500

PV DC Isolator	Product Code	Item Description
	RIIGEx9IP 2P 63A	PV DC Isolator 2P 500V
	RIIGEx9IP 4P 63A	PV DC Isolator 4P 1000V

Fuseholder	Product Code	Item Description
	RIIGEx9FP 1P	PV Fuse Holder 1P
	RIIGEx9FP 2P	PV Fuse Holder 2P

Fuse Switch Disconnecter	Product Code	Item Description
	RIIGNHR17-160/3	Fuse Switch Disconnecter 160A 3P
	RIIGNHR17-250/3	Fuse Switch Disconnecter 250A 3P
	RIIGRT36-00 63A	Fuse 63A AC500V/DC250V gG/gL(NHR17-160)
	RIIGRT36-00 80A	Fuse 80A AC500V/DC250V gG/gL(NHR17-160)
	RIIGRT36-00 100A	Fuse 100A AC500V/DC250V gG/gL(NHR17-160)
	RIIGRT36-00 125A	Fuse 125A AC500V/DC250V gG/gL(NHR17-160)
	RIIGRT36-00 160A	Fuse 160A AC500V/DC250V gG/gL(NHR17-160)
	RIIGRT36-1 200A	Fuse 200A AC500V/DC440V gG/gL(NHR17-160)
	RIIGRT36-1 250A	Fuse 250A AC500V/DC440V gG/gL(NHR17-160)

PV Fuses	Product Code	Item Description
	RIIGRT18-32/10A	PV Fuse 10A 1000VDC
	RIIGRT18-32/16A	PV Fuse 16A 1000VDC
	RIIGRT18-32/20A	PV Fuse 20A 1000VDC
	RIIGRT18-32/25A	PV Fuse 25A 1000VDC
	RIIGRT18-32/32A	PV Fuse 32A 1000VDC
	RIIGRT18-32 1P Fuse Holder	PV Fuse Holder with Indicator

DC Circuit Breakers	Product Code	Item Description
	RIIGNM8NDC-125S TM 100 2P	DC Circuit Breaker 100A 50KA DC500V Adjustable (0.7-1In)
	RIIGNM8NDC-125S TM 125 2P	DC Circuit Breaker 125A 50KA DC500V Adjustable (0.7-1In)
	RIIGNM8NDC-250S TM 160 2P	DC Circuit Breaker 160A 50KA DC500V Adjustable (0.7-1In)
	RIIGNM8NDC-250S TM 200 2P	DC Circuit Breaker 200A 50KA DC500V Adjustable (0.7-1In)
	RIIGNM8NDC-250S TM 250 2P	DC Circuit Breaker 250A 50KA DC500V Adjustable (0.7-1In)
	RIIGNM8NDC-125S TM 125 3P	DC Circuit Breaker 125A 50KA DC750V Adjustable (0.7-1In)
	RIIGNM8NDC-250S TM 160 3P	DC Circuit Breaker 160A 50KA DC750V Adjustable (0.7-1In)
	RIIGNM8NDC-250S TM 200 3P	DC Circuit Breaker 200A 50KA DC750V Adjustable (0.7-1In)
	RIIGNM8NDC-250S TM 250 3P	DC Circuit Breaker 250A 50KA DC750V Adjustable (0.7-1In)
	RIIGNM8NDC-400S TM 315 3P	DC Circuit Breaker 315A 50KA DC750V Adjustable (0.7-1In)
RIIGNM8NDC-400S TM 400 3P	DC Circuit Breaker 400A 50KA DC750V Adjustable (0.7-1In)	

DC Isolators	Product Code	Item Description
	RIIGEDSC100R-EL32R-4S	DC Isolator 32A 4P 1000V 1000V IP66

Din Rail DC Isolators	Product Code	Item Description
	RIIGEDS1DB/S32/4TR	DC Isolator 32A 4P 1200V Din Rail



LIGHTING

SOLAR FLOOD LIGHT EL-TJ SERIES



- Remote control and light control
- Charging time effective sunshine 4-6 hours
- Auto Mode Max. Working Hours 14 hours

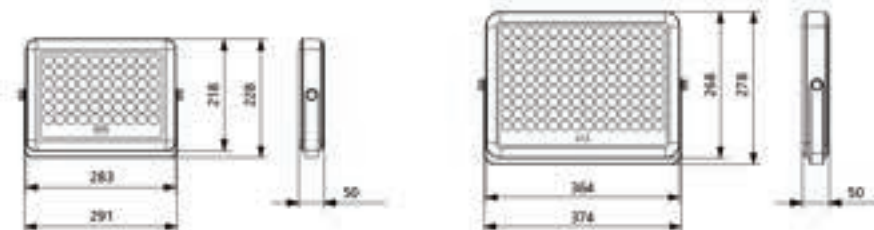

Product Code	LED Source Power	Lumen	Solar Panel	Battery	Lamp Body Size	Solar Panel Size
RIIGEL-TJ-100	100W	1200lm	12W6V	12AH	210*168*50mm	235*350*16mm
RIIGEL-TJ-150	150W	2000lm	15W6V	15AH	243*194*50mm	290*350*17mm
RIIGEL-TJ-200	200W	2600lm	20W6V	20AH	283*218*50mm	350*350*17mm
RIIGEL-TJ-250	250W	3200lm	25W6V	25AH	323*244*50mm	350*450*17mm
RIIGEL-TJ-300	300W	3800lm	30W6V	30AH	364*268*50mm	350*530*17mm

EL-YT2 SERIES

INTEGRATED SOLAR STREET LIGHT



Product Code	LED Source Power	Lumen	Solar Panel	Battery	Lamp Body Size	Solar Panel Size
RIIGEL-YT2-150/3	150W	600lm	6W6V	5AH	380*180*55mm	172*291mm
RIIGEL-YT2-200/4	200W	1200lm	10W6V	9AH	470*202*55mm	194*383mm
RIIGEL-YT2-250/5	250W	1800lm	14W6V	13AH	550*220*55mm	208*498mm
RIIGEL-YT2-300/6	300W	2400lm	18W6V	16.5AH	670*220*55mm	208*578mm

EL-YT4 SERIES

INTEGRATED SOLAR STREET LIGHT



Product Code	LED Source Power	Lumen	Solar Panel	Battery	Lamp Body Size	Solar Panel Size
RIIGEL-YT4-100/2	100W	600lm	6W6V	5AH	378*188*60mm	171*336mm
RIIGEL-YT4-150/3	150W	1200lm	10W6V	9AH	495*188*60mm	171*456mm
RIIGEL-YT4-200/4	200W	1800lm	14W6V	13AH	586*188*60mm	171*547mm
RIIGEL-YT4-250/5	250W	2400lm	18W6V	16.5AH	700*188*60mm	171*638mm

LED SOLAR CEILING LIGHT EL-XD SERIES

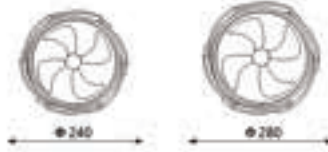

Product Code	LED Source Power	Lumen	Solar Panel	Battery	Lamp Body Size	Solar Panel Size
RIIGEL-XD-200	200W	600lm	8W/6V	5AH	Ø240*70mm	270*180*16mm
RIIGEL-XD-300	300W	800lm	10W/6V	6AH	Ø280*70mm	235*350*16mm



SOLAR GARDEN LIGHT EL-UFO SERIES

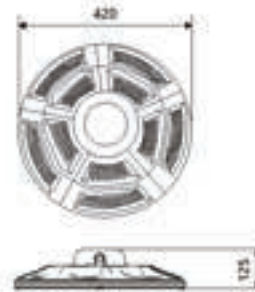

Product Code	LED Source Power	Lumen	Solar Panel	Battery	Lamp Body Size	Solar Panel Size
RIIGEL-UFO-180	180W	2000lm	15W/6V	15AH	Ø420*125mm	Ø420mm

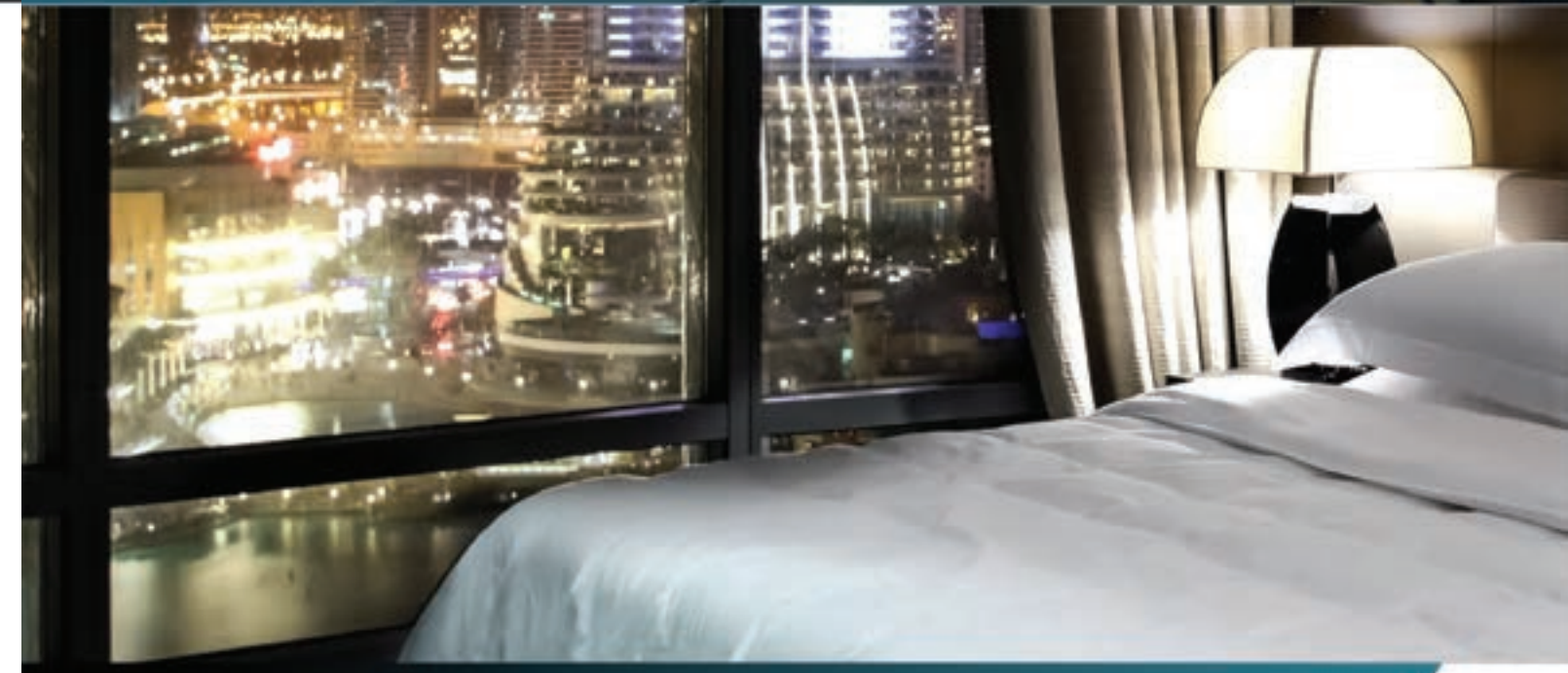

POWER SUPPLY

Power Supply	Product Code	Item Description
	RIIGNKY2-75W-DC12V	DIN Rail Power Supply 75W, Input AC 90V-264V, Output DC12V
	RIIGNKY2-75W-DC24V	DIN Rail Power Supply 75W, Input AC 90V-264V, Output DC24V
	RIIGNKY2-75W-DC48V	DIN Rail Power Supply 75W, Input AC 90V-264V, Output DC48V
	RIIGNKY2-120W-DC12V	DIN Rail Power Supply 120W, Input AC 90V-264V, Output DC12V
	RIIGNKY2-120W-DC24V	DIN Rail Power Supply 120W, Input AC 90V-264V, Output DC24V
	RIIGNKY2-120W-DC48V	DIN Rail Power Supply 120W, Input AC 90V-264V, Output DC48V
	RIIGNKY2-240W-DC12V	DIN Rail Power Supply 240W, Input AC 90V-264V, Output DC12V
	RIIGNKY2-240W-DC24V	DIN Rail Power Supply 240W, Input AC 90V-264V, Output DC24V
	RIIGNKY2-240W-DC48V	DIN Rail Power Supply 240W, Input AC 90V-264V, Output DC48V
	RIIGNKY2-480W-DC12V	DIN Rail Power Supply 480W, Input AC 90V-264V, Output DC12V
	RIIGNKY2-480W-DC24V	DIN Rail Power Supply 480W, Input AC 90V-264V, Output DC24V
	RIIGNKY2-480W-DC48V	DIN Rail Power Supply 480W, Input AC 90V-264V, Output DC48V





+27 11 568-7166



sales@bshockedelectrical.co.za



+27 11 568-7166

B | SHOCKED 