

ADONIS

Congratulations, you have chosen an unique in its kind machine.
Read carefully what is advised in the instruction manual for “setting-up” of your “ADONIS”.
You will see how easy it is to make delicious coffee and creamy cappuccinos.
With the passing of time, you will also realise how little maintenance is needed.

Victoria Arduino

ADONIS

ADONIS

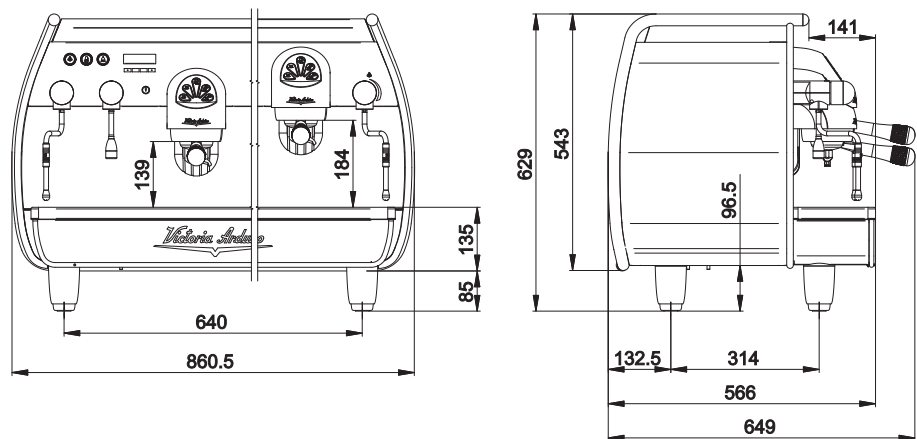

Model: ADONIS 2 groups - Net weight: 84 Kg - Gross weight: 90 Kg - Thermal power: 4500 W - Boiler capacity 14 lt - Volts 230-380V 50/60Hz

Model: ADONIS 3 groups - Net weight: 98 Kg - Gross weight: 108 Kg - Thermal power: 5000 W - Boiler capacity 17 lt - Volts 230-380V 50/60Hz

 The approval mark certifies that all machines have been subjected to accurate inspection tests and checks

INDEX

TECHNICAL CHARACTERISTICS	37	5.3	HOT WATER ECONOMISER ADJUSTMENT	48
1. GENERAL REMARKS ON THE CONSIGNMENT	39	5.4	CLOCK BATTERY REPLACEMENT	49
1.1 SAFETY REGULATIONS.....	39	6.	USE	50
2. DESCRIPTION	41	6.1	TURNING THE MACHINE ON	50
2.1 ACCESSORIES LIST	42	6.2	LED SWITCH ON	52
3. TRANSPORT AND HANDLING	43	6.3	BUTTONS KEY (<i>Selection Configuration</i>).....	52
3.1 APPLIANCE IDENTIFICATION.....	43	6.4	STEAM FLOW ADJUSTMENT.....	53
4. INSTALLATION AND PRELIMINARY OPERATIONS	44	6.4	ADJUSTING THE TURBOCREAM NOZZLE (<i>If Fitted</i>).....	53
5. ADJUSTMENTS TO BE MADE BY A QUALIFIED TECHNICIAN ONLY	46	6.4	ADJUSTING THE AUTOSTEAM NOZZLE (<i>If Fitted</i>).....	54
5.1 FILLING BOILER MANUALLY.....	46	7.	PROGRAMMING	55
5.2 PRESSOSTAT / PUMP ADJUSTMENT.....	47	7.1	KEY.....	55
5.2.1 PUMP ADJUSTMENT.....	47	7.2	PROGRAMMING.....	55
5.2.2 PRESSOSTAT ADJUSTMENT.....	47	8.	CLEANING AND MAINTENANCE.....	65
		8.1	SWITCHING OFF THE MACHINE	65
		8.2	CLEANING THE OUTSIDE OF THE MACHINE	65
		8.3	CLEANING THE STAINLESS COFFEE-HOLDERS.....	65
		8.4	CLEANING THE UNIT WITH THE AID OF THE BLIND FILTER.....	66
		8.5	CLEANING FILTERS AND FILTER-HOLDERS	66
		9.	MACHINE FUNCTION MESSAGES	67

1. GENERAL REMARKS ON THE CONSIGNMENT

1.1 SAFETY REGULATIONS

❶ The present manual is an integral and essential part of the product and will have to be handed over to the user. Read carefully the written warnings in the present manual as they give important suggestions concerning the safety of installation and set-up, use and maintenance. Keep this manual in a safe place for further information.

POLLUTION DANGER

❷ After removing the packaging, check the integral parts of the machine are intact. If in doubt, do not use the machine and contact the professionally qualified personnel. The elements of the packaging must be kept out of children's reach as they can be potential sources of danger and they mustn't be disposed of in the environment.

❸ Before connecting the machine, make sure that the data of the plate correspond to those of the electrical distribution network. The plate is located under the machine's base. The installation has to be carried out in compliance with the regulations of the Country where the machine is set-up, according to the instructions by the manufacturer and qualified personnel.

The manufacturer can't be considered responsible for possible damage caused by failure in earthing the plant. For the electrical safety of this machine it is obligatory to arrange the earthing plant, contact an electrician with proper and certified technical suitability, to check the electrical capacity of the plant is adequate to the maximum power of the machine, stated on the plate. In particular the electrician will have to make sure that the section of the plants' cables is suitable to the power absorbed by the machine.

The use of adaptors, multi-sockets and extensions is forbidden. If their use is necessary, it is compulsory to call a licensed electrician.

❹ The machine must be set-up according to the sanitary and health regulations valid for hydraulic plants. For the hydraulic plant contact an authorised technician.

❺ This machine will have to be used only for the purpose described in this manual.

The manufacturer can't be considered responsible for possible damage caused by improper, wrong, or unreasonable uses.

WARNING

Before using the machine read carefully and completely the instruction manual, safety regulations and the machine tuning/ directions.

❻ The use of any electrical device must comply with fundamental regulations. In particular:

- do not touch the machine with wet hands or feet;
- do not use the machine barefoot;

- do not use extensions in places used as a bath or shower;
- do not pull the supply cable, to disconnect the machine from the supplying net;
- do not leave the machine exposed to atmospheric agents (rain, sun, etc);
- do not allow the machine to be used by children or by non-authorized personnel that haven't read and understood this manual.

7 The authorised technician has to, before carrying out any maintenance operation, unplug the socket after having switched off the machine switch.

7 bis For the cleaning operations bring the machine to energetic state "O", that is to say "**machine is switched off and socket unplugged**" and keep exclusively to what is stated in the present manual.

8 In case of breakdown or wrong functioning of the machine, switch it off.
Any intervention is strictly forbidden.
Contact exclusively professionally authorised personnel.

The possible repair of the products will have to be made by the manufacturer only or by an authorised service using exclusively original spare parts.
Non-compliance with the above stated can compromise the safety of the machine.

9 When setting it up, the licensed electrician will have to check an omni-polar switch is provided by the actual safety regulations with opening distance from the contacts the same or bigger than 3 mm.

10 To avoid dangerous overheating, we do recommend you uncoil the supply cable to its full length.

11 The user mustn't replace the supply cable of this machine. In case of damage, switch the machine off and for its replacement contact exclusively professionally qualified personnel.

12 In the event that you decide not to use a machine of this kind anymore, we advise you make it ineffective by unplugging the socket, then cut the supply cable.

WARNING DANGER OF POLLUTION

Do not dispose of the machine in the environment: for waste disposal, contact a specialised authorised centre or contact the manufacturer that will give you information about this.

13 To help the aeration of the machine place it 15 cm from the walls or from other machines on the aeration side.

WARNING DANGER OF BURNING

14 When using the vapour spear, pay much attention and do not place hands under it and do not touch it immediately after its use.

15 Remember that before carrying out any set-up operation, maintenance, download, or tuning, the qualified operator has to wear working gloves and safety shoes.

2. DESCRIPTION ADONIS

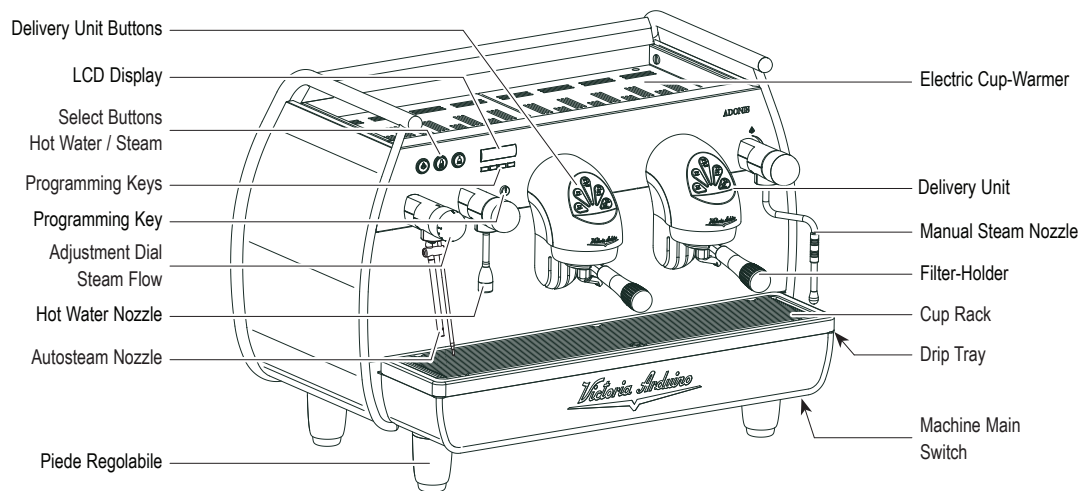

Fig. 1

2.1 ACCESSORIES LIST

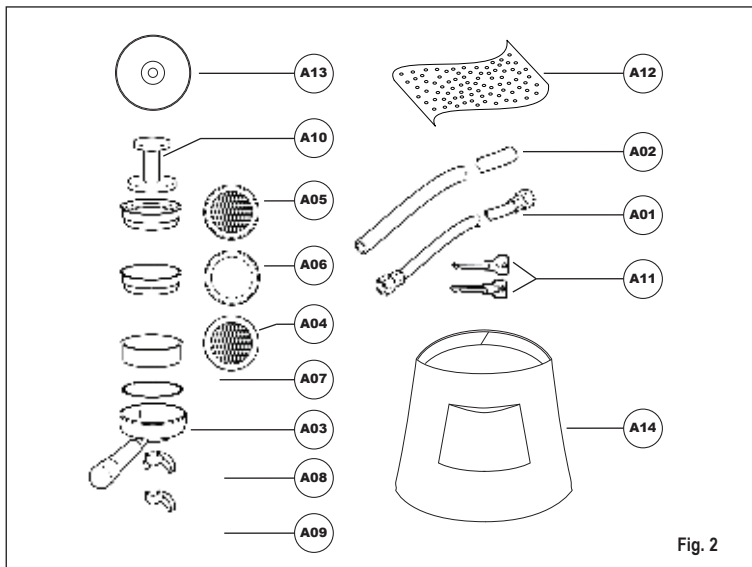

Fig. 2

CODE	DESCRIPTION	2 GROUPS	3 GROUPS
A01	Filling tube 3/8"	1	1
A02	Worktop draining tube Ø 25 mm - l. 150 cm	1	1
A03	Filter-holder	3	4
A04	Double filter	2	3
A05	Single filter	1	1
A06	Blind filter	1	1
A07	Spring	3	4
A08	Double delivery spout	2	3
A09	Single delivery spout	1	1
A10	Coffee presser	1	1
A11	'U' and 'T' keys	1	1
A12	Microfibre cloth	1	1
A13	DVD	1	1
A14	Overall	1	1

3. TRANSPORT AND HANDLING

3.1 APPLIANCE IDENTIFICATION

When contacting the manufacturer, Victoria Arduino for any reason, always quote the machine serial number.

The machine is transported on pallets containing several machines inside boxes secured to the pallet by straps.

Before performing any transport or handling operation, the operator must:

- wear safety gloves and footwear and overalls with elasticised ends.

Pallets must be transported using an adequate lifting mechanism (fork-lift truck type).

⚠ CAUTION: COLLISION OR CRUSHING HAZARD

During the entire handling operation, the operator must make sure no one or nothing is inside the operating area.

Slowly lift the pallet to about 30 cm from the ground and

move to the loading area. After making sure there are no obstacles, persons or things, proceed with loading.

Once at destination, always using an adequate lifting mechanism (eg. fork-lift), after making sure there is no one or nothing within the unloading area, lower the pallet to about 30 cm from the ground and transport it to the storage area.

⚠ CAUTION: COLLISION OR CRUSHING HAZARD

Before performing the following operation, make sure the load is in place and is not likely to fall when the straps are cut.

The operator, wearing safety gloves and footwear, must now cut the straps and store the product. To perform this operation, check the technical characteristics of the product to determine the weight of the machine to be stored and take consequent precautions.

⚠ CAUTION: POLLUTION HAZARD

Once the machine has been freed of the pallet or container, do not discard these in the environment - pollution hazard.

4. INSTALLATION AND PRELIMINARY OPERATIONS

After unpacking, assess that the machine and its accessories unit are complete, then proceed as follows:

- place the machine so that it is level on a flat surface;
- assemble its supporting feet by inserting the insert into the cylindrical unit (see Fig. 3);
- twist the rubber foot into the screw thread inside the unit (see Fig. 3);
- screw the whole assembled unit into the allotted setting for the machine's adjustable feet;
- level the machine by regulating the adjustable feet;

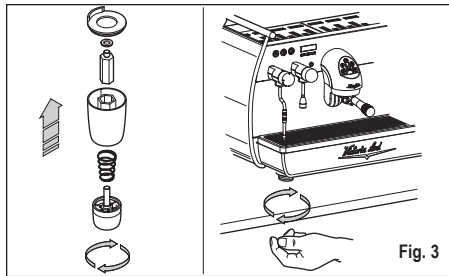

It is advisable to install a softener (1) and then a mesh filter (2) on the external part of the plumbing system, during preliminaries and after levelling the machine.

In this way impurities like sand, particles of calcium, rust etc will not damage the delicate graphite surfaces and durability will be guaranteed.

Following these operations, connect the plumbing systems as illustrated in the following figure.

⚠ WARNING

Avoid throttling in the connecting tubes.

Assess that the drain pipe (3) is able to eliminate waste.

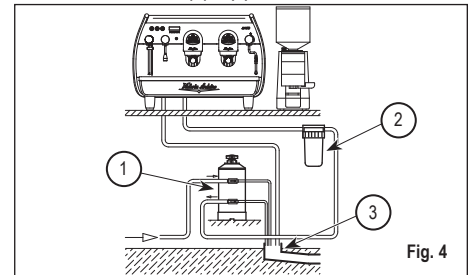

KEY

- ① Softener
- ② Mesh filter
- ③ Drain Ø 50 mm

⚠ NOTE

The unit grooves have to face upwards, as shown in the following illustration.

⚠ NOTE

For a correct functioning of the machine the water works pressure must not exceed 4 bars. Otherwise install a pressure reducer upstream of the softener; the internal diameter of water entrance tube must not be less than 6mm (3/8").

⚠ CAUTION RISK OF SHORT CIRCUITS

The machine must always be protected by an automatic omnipolar switch of suitable power with contact openings of equal distance or more than 3mm. Nuova Simonelli is not liable for any damage to people or objects due to not observing current security measures.

Prior to connecting the machine to the electrical mains, assess that the voltage shown on the machine's data plate corresponds with that of the mains. If it does not, carry out the connections on the basis of the available electrical line, as follows:

- for **V 380** / 3 phases voltage + Neutral:

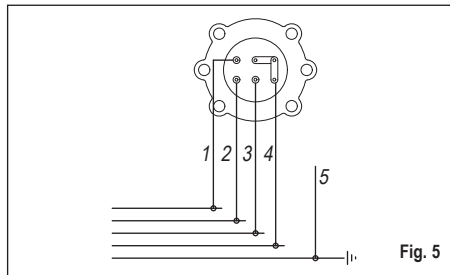

Fig. 5

- for **V 230** / monophase voltage:

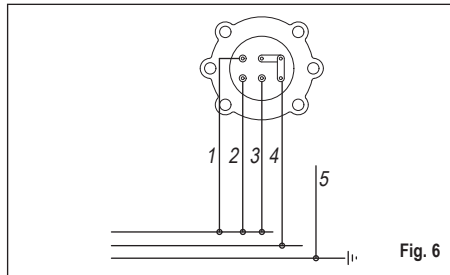

Fig. 6

KEY

- ① Black
- ② Grey
- ③ Brown
- ④ Blue
- ⑤ Yellow-green

5. ADJUSTMENTS TO BE MADE BY A QUALIFIED TECHNICIAN ONLY

5.1 FILLING BOILER MANUALLY

⚠ NOTE

This operation must be carried out with the machine turned off.

All models **ADONIS** are equipped with a level gauge to keep the water level inside the boiler constant.

When using the machine for the first time, it is advisable to fill the boiler by hand to avoid damaging the electrical resistor and turning on the electronic protection.

If this should happen, just turn the machine off and then start it up again to complete its loading procedure (see chapter **"MACHINE FUNCTIONS MESSAGE – LEVEL ERROR"**).

To fill the boiler manually for the first time, proceed as follows:

- remove the grid and the drip tray;
- remove the protective metal sheet by unscrewing the two side screws "A" as shown in the following illustration;

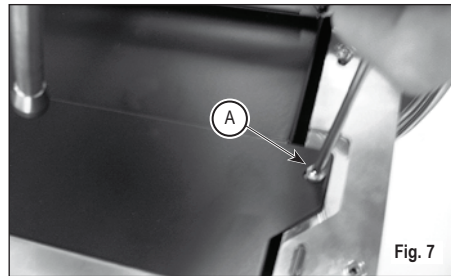

- turn the manual "A" level tap so that water will enter the boiler;
- after about 45 seconds, shut off the valve "A" as illustrated in the following figure;

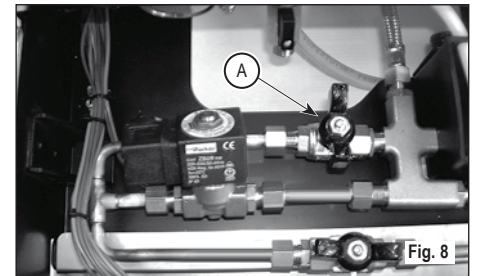

- switch on the machine (see the chapter **"SWITCHING ON THE MACHINE"**).

5.2 PRESSOSTAT / PUMP ADJUSTMENT

NOTE

This operation can be carried out while the machine is turned on.

To adjust the service pressure of the boiler, thus regulating the water temperature, according to the various functions and needs of the coffee desired, proceed as follows:

- remove the grid and the drip tray;
- remove the protective metal sheet by unscrewing the two side screws "A" as shown in the following illustration;

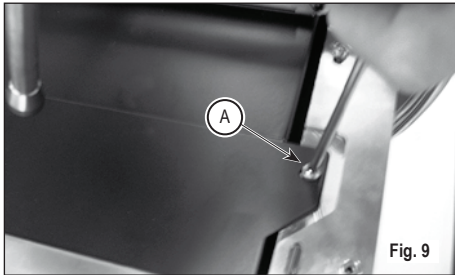

5.2.1 PUMP ADJUSTMENT

- Turn the pump registration screw, turning it clockwise to INCREASE and counter clock wise to DECREASE the pressure;

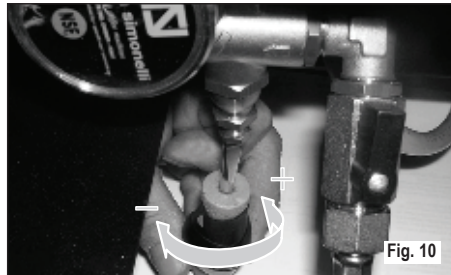

Advisable pressure: 9 bar

5.2.2 PRESSOSTAT ADJUSTMENT

- Use the adjustment screw for the pressure switch to INCREASE (anticlockwise) or REDUCE (clockwise) the pressure in the boiler tank;

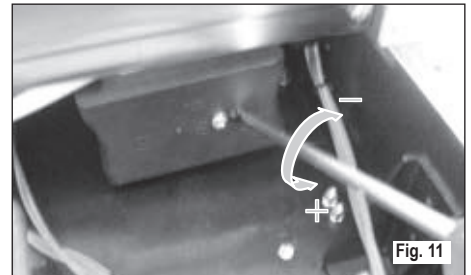

Advisable pressure: 1 - 1,4 bar
(according to the kind of coffee)

- The set pump pressure is displayed in the bottom section "B" of the pressure gauge, inside the machine (see Fig. 12);
- The pressure set on the pressure switch is displayed in the top section "C" of the pressure gauge, inside the machine (see Fig. 12);

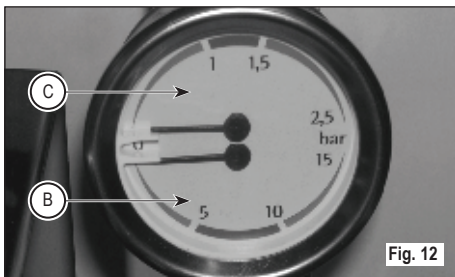

Fig. 12

At the end of the adjustment process, refit the sheet metal guard on the relevant housing and secure it in place with the two side screws. Refit the drip tray and the work surface grid.

- To access the pressure gauge, remove the cup warmer section on the left by loosening the two screws "D" as illustrated in the following figure.

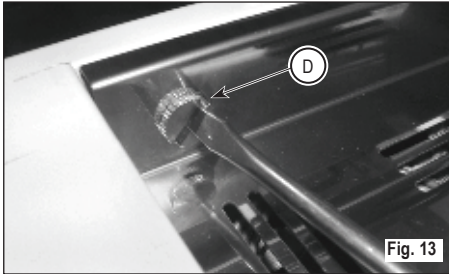

Fig. 13

5.3 HOT WATER ECONOMISER ADJUSTMENT

⚠ NOTE

This operation can be carried out while the machine is turned on.

All models **ADONIS** are equipped with a hot water mixer tap which adjusts the water temperature and optimises the system's performance.

To adjust the hot water economiser, turn the registration knob.

- The hot water economiser is located inside the machine.

- To access the economiser, remove the cup warmer section on the left by loosening the two screws "D" as illustrated in the following figure.

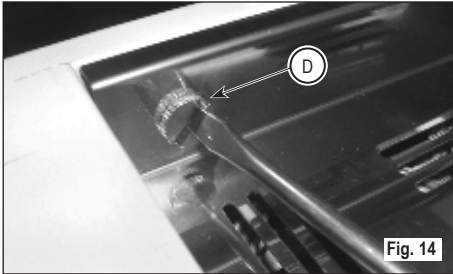

- Turn the adjustment knob ANTICLOCKWISE / CLOCKWISE to INCREASE / REDUCE the temperature of the hot water;

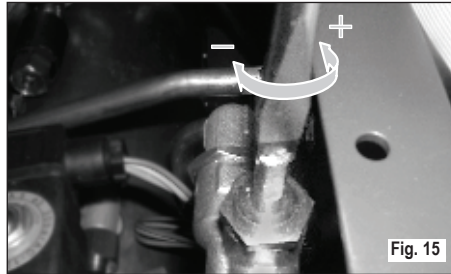

- when the operation has been completed, screw the protective panel back on.

5.4 CLOCK BATTERY REPLACEMENT

The electronic control unit is equipped with a lithium battery to provide the clock with an approximately three-year autonomy period, after which replacing the battery may prove necessary.

In case the machine has remained unutilised for a long time, the clock can be blocked by proceeding as follows:

- with the machine off the display will read:



- press the **ENTER** key for 5 seconds; the display will read:



The clock will start up again as soon as the machine is plugged in once more.

⚠ WARNING

Replacement of the lithium battery must be carried out EXCLUSIVELY by Qualified Technician.

Nuova Simonelli cannot be held liable for any damage to people or things due to non observance of the safety prescriptions described in this booklet.

6. USE

Before starting to use the appliance, the operator must be sure to have read and understood the safety prescriptions contained in this booklet.

The **ADONIS** model is equipped with a display key **T** and a technical key **U**. With the display key **T** it is possible to access the normal operating functions, while programming menus can be seen but not modified (**Chapter 7**).

The technician **U** key allows you to access all the functions and to modify the parameters of the programming menu.

6.1 TURNING THE MACHINE ON

- Plug the machine in and position the main switch "A" on "I".

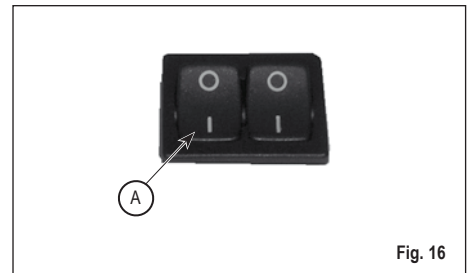

Fig. 16

- The unlit display will read:



⚠ NOTE

The machine is not operative in that the main switch only supplies the electronic card.

⚠ WARNING

For electronic card maintenance, turn the machine off by means of the external main switch or disconnect the plug.

MANUAL SWITCHING ON / OFF

Automatic On / Off NOT PROGRAMMED

SWITCH ON

press the **RESET** key for 2 seconds, the buzzer will beep, the display will light up to indicate the release of the EPROM for about 1 second.

The control unit will start up an auto diagnosis cycle to check the functions, all the selection keys will light up. Once the check is completed the display will read:

[REDACTED]
with the day and time. When 110°C has been reached, the heating message will disappear and will be replaced by the words:

⚠ NOTE

On completion of the check up all the selection keys are activated.

⚠ WARNING

In case the auto diagnosis indicates error or malfunction, call an assistance centre; the operator **MUST NOT** intervene.

POWER OFF

press the **RESET** key for 2 seconds; the machine will turn off and the display will read:

Automatic On / Off PROGRAMMED

The machine will SWITCH ON at the first programmed switch-on time (see the section entitled **PROGRAMMING** at the paragraph **PROGRAMMING ON - OFF**).

The control unit will perform an auto diagnosis of all functions and all of the selection keys will light up. Once the diagnosis is complete, the display will read as follows:

with the date and time. Once the temperature of 110°C has been the word "Heating" will disappear to be replaced by:



⚠ NOTE

Once the auto diagnosis has been completed all the keys are activated.

⚠ WARNING

In case the auto diagnosis indicates error or malfunction, call the assistance centre; the operator **MUST NOT** intervene.

The machine will **SWITCH OFF** at the first time set for stopping the coffee maker (see chapter on **PROGRAMMING** and paragraph on **PROGRAMMING ON – OFF**).

⚠ NOTE

the machine can be switched on or off manually as indicated in the previous paragraph.

6.2 LED SWITCH ON

- Plug the machine in and position the main switch "B" on "1".



Fig. 17

6.3 BUTTONS KEY

Selection Configuration

	
1 Small coffee	2 Small coffees
	
1 Long coffee	2 Long coffees
	
Continuous	Hot Water
	
Steam	Cup Warmer

6.4 STEAM FLOW ADJUSTMENT

Use the dial to increase/reduce the flow of steam injected into the milk, as illustrated in the following figure.

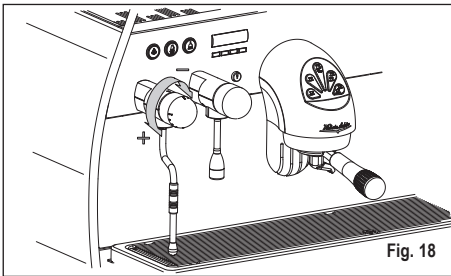

6.5 ADJUSTING THE TURBOCREAM NOZZLE (If Fitted)

To increase/reduce the amount of air injected into the milk from the TurboCream nozzle (and therefore to increase/reduce the amount of foam in the heated milk) proceed as illustrated in **Fig. 19**:

- ① Loosen the stainless steel tube (1) as illustrated in **Fig. 19.A**.
- ② To increase/reduce the amount of air, tighten (turning clockwise) or loosen (turning anticlockwise) the Teflon tube (2) as illustrated in **Fig. 19.B**.
- ③ Tighten the stainless steel tube again.

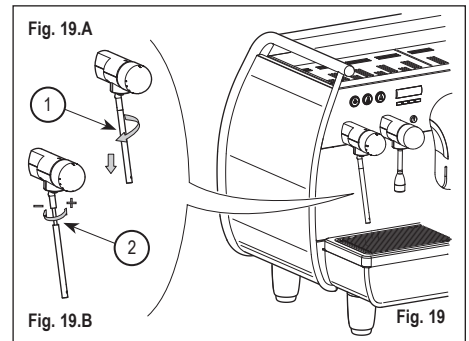

⚠ NOTE

By reducing or increasing the length (tightening or loosening) the tube/Teflon tube by a few fractions of a mm/mm, there is a significant difference in the amount of foam in the heated milk.

6.6 ADJUSTING THE AUTOSTEAM NOZZLE (If Fitted)

To increase/reduce the amount of air injected into the milk from the TurboCream nozzle (and therefore to increase/reduce the amount of foam in the heated milk) proceed as illustrated in Fig. 20:

- ① Loosen the stainless steel tube (1) as illustrated in Fig. 20.A.
- ② To increase/reduce the amount of air, tighten (turning clockwise) or loosen (turning anticlockwise) the Teflon tube (2) as illustrated in Fig. 20.B.
- ③ Tighten the stainless steel tube again.

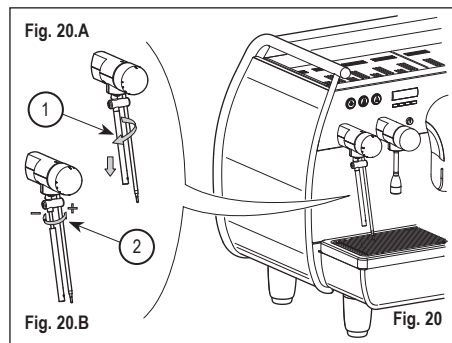

⚠ NOTE

By reducing or increasing the length (tightening or loosening) the tube/Teflon tube by a few fractions of a mm/mm, there is a significant difference in the amount of foam in the heated milk.

- ④ As far as concerns temperature settings, see the relevant programming section.

7. PROGRAMMING

7.1 KEY

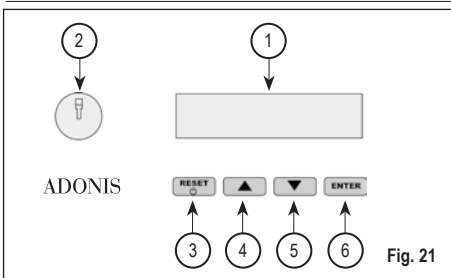





Fig. 21

- ① LCD Display.
- ② Technician/waiter key lock.
- ③ **RESET** Key: to turn the machine on and off and to exit menu.
- ④ **CURSOR** Key: to scroll the menu and to increase and decrease values.
- ⑤
- ⑥ **ENTER** Key: to access the menu.

LIST OF PROGRAMMABLE FUNCTIONS

AUTO.CLEAN.CYCLE 
 DOSE PROGRAM. 
 DELIVERY COUNT 
 ON-OFF PROGRAM. 
 CUP-WARMER PRO. 
 DATE/TIME 
 GRINDING 
 HISTORICAL ALARM 
 MAINTENANCE 
 LANGUAGE 
 TEMPERATURE 
 LIGHT ADJUST 



Operation to be carried out **EXCLUSIVELY** by a Qualified Technician. Adjustment by NON qualified technicians can invalidate the guarantee.

7.2 PROGRAMMING

To access the programming units, proceed as follows:

NOTE

The procedure can be carried out with the machine on.

- Insert the key marked **U** (see chapter "USE") in the provided keyhole.

AUTOMATIC CLEANING CYCLE



(function also available with T visualization key)

- Press the **▼** key to access program; the display will read:



- Press **ENTER** and the display will read:





- The central key in each unit  will begin to flash on and off. Insert the blind filter (**Fig 2 A06**) into the filter-holder, add half a dose of PULICAFF and attach the filter-holder into the unit where you intend to carry out the automatic cleaning cycle. Carrying out a cleaning cycle in more than one unit at a time is possible.
- Press the  key to start the unit automatic cleaning cycle. The display will read:



where 1L indicates that the cleaning cycle has been activated within the 1st unit. Once the cycle of 15 deliveries of 5 seconds each, with a 10-

second pause between each delivery, has been completed the selected unit  key will begin to flash on and off again and the display will read.



- Eliminate any residues of PULICAFF from the blind filter and press  the rinsing cycle starting up key of the unit or units where the cleaning cycle has been effected. The letter R will remain on the display like the key . Once the rinsing cycle of the selected unit or units has been completed, the display will read.



PROGRAMMING DOSES

- Press the **▼** key to access the programming; the display will read:



- Press **ENTER** and the display will read:



- All the programmable keys will start to flash on and off.
- Press the coffee key you wish to program; the display will read:



Followed by the dose amount already set by the manufacturers.

- Vary the dose, by pressing the buttons **▼ ▲**.
- By pressing the coffee key you want to program, delivery will be started up (in the meantime all the other keys will turn off).
- Select the dose of delivered coffee and then press the coffee key you want to program again.
- The display will show the new dose amount which can still be changed by means of the keys **▼ ▲**.

- Going on to another selection or pressing the **ENTER** key.
The set coffee key will turn off.

HOT WATER

- Press the  button and make sure that it lights up.
The display will read:



followed by the value already set by the manufacturers.
Press the ▼ ▲ keys to vary the hot water delivery time.

- If a new sampling is desired press the  button again.

Delivery starts. When the desired dose has been reached press the button again  .

- The display will show the new dose value set which can still be changed by pressing the ▼ ▲ keys.
- Press the **ENTER** key or go on to a further selection to terminate the operation.
The  button will turn off.

TIMED STEAM

- Press the  button and make sure it lights up. In those models provided with a temperature probe (optional) the control unit automatically recognizes the presence of the probe and the display will read:



followed by the temperature set previously by the manufacturer.

Press the ▼ ▲ keys to vary the temperature of the beverage you want to heat. When the desired temperature has been reached, the steam delivery will automatically stop.

- In the standard version (without temperature probe), on pressing the  the display will read:



followed by the amount already set by the manufacturers.
Press the ▼ ▲ keys to vary the steam delivery time.

- If a new sampling is desired press the  button again.

Delivery starts. When the desired dose has been reached press the button again  .

- The display will show the new value set which can still be changed by pressing the ▼ ▲.
- Press the **ENTER** key or go on to a further selection to terminate the operation.
The  button will turn off.

TRANSFERRING DOSES

- When the display reads:



transferring the set dose to other units is possible by pressing the ▼ key.
The display will read:



at this point all the delivery buttons belonging to each individual unit will flash as illustrated in **Fig. 22**.

- By selecting the  continue key once on the first unit (the key will stop flashing but remain lit up), the set values will be transferred from the first unit to the other units.

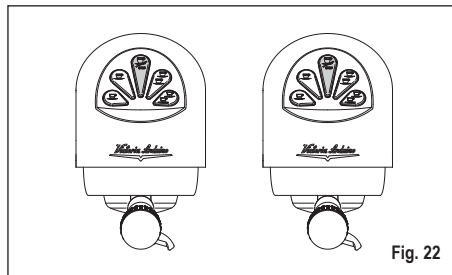

Fig. 22

- Press the **ENTER** key to confirm.
At this point the display will read:



- Press the **RESET** or the ▲ key to exit without confirmation.

STANDARD DOSES

- When the display reads:



we mean to recall the standard dose values.

- Press the ▼ key.
The display will read:



Once again the delivery buttons will begin to flash (**see. Fig. 31**) on and off.

- Select one or more continue keys (the key or keys selected will remain lit up).
The key or keys will recall the selected unit's standard doses.
- Press the **ENTER** key to confirm.
The display will read:



NOTE

all the selections can be programmed for a maximum of two minutes; after that time a flashing message will appear on the display saying:



DELIVERY COUNT

- The display will read:



- By pressing the **ENTER** key the display will read:

- All the delivery keys will start to flash on and off. By pressing one of the delivery keys the amount of the deliveries made will be visualised.
- To set the counter back to zero, press the **RESET** key.

NOTE

The continuous coffee equals one delivery.

- Press **ENTER** to access waiter counts (if provided).
- Press the **▼** key and the display will read:



All the units' small coffee keys  will begin to flash on and off.

Example:

By selecting one of the first unit's keys (the selected key will remain lit up) the display will read:



which means the total amount of deliveries for that unit.

- To set the counter back to zero press **RESET**.
- To access the waiter counter press **ENTER**.
- When the display reads:



press **▼** and the display will read:





This indicates the total amount of deliveries made.

- To set the counter back to zero press **RESET**.
- To access total counts per waiter press **ENTER**.
- By pressing the ▼ key the display will read:

[Redacted display]

To access the automatic cleaning counter press **ENTER**.

- The  keys will flash on and off; by pressing the unit key the number of cleaning cycles effected will appear. By pressing the  key (reset) for 5 seconds the counter will be set back to zero.

ON / OFF PROGRAM.

- The display reads:
- By pressing the **ENTER** key, the display will read:

[Redacted display]

ON 07:30 OFF 23:30

where the ON and OFF values indicate when the machine will turn on and off.

- Press ▼ ▲ to change the day forward and backward.
- Press **ENTER** to vary the programmed starting up time (the message ON 07:30 will start to flash on and off).
- Use the ▼ ▲ keys to vary the starting up time.

- Press **ENTER** to confirm and to go on to the programmed switching off time (the message OFF 23:30 will start to flash on and off).
- Use the ▼ ▲ keys to vary the switching off time.
- Confirm by pressing **ENTER**.
- To de-activate the on/off function on weekly day-off, press **RESET**.

The display will read:

[Redacted display]

(to reinstate, press **RESET**)

After the word SUNDAY, by pressing ▼ again, a beep will signal that you have come to the following page.

CUP-WARMER PROGRAMMING

- The display will read:



- By pressing the **ENTER** key, the display will read (for example):



The words ON05 will begin to flash on and off; use the ▼ ▲ keys to vary the opened cup-warming time (anywhere between 0 and 60 minutes).

- Press **ENTER** to confirm and to set the cup-warmer at OFF, which includes from 0 to 60 minutes.

⚠ NOTE

By programming one of the two ON/OFF values at 0, will automatically exclude the function.

When the cup-warmer has been set, the button  will start to slowly flash.

- Press the **ENTER** key to go on to the next page.

DATE/TIME PROGRAMMING

- The display will read:



- By pressing the **ENTER** key, the display will read for example:



The times will start to flash on and off.

- Vary the hours and the minutes by using the keys ▼ ▲.
- Confirm by pressing the **ENTER** key.

Once the hours and the minutes have been varied press **ENTER** again and vary the day, the month and the year by using the same procedure as

described above.

On completion press **ENTER** to go on to the next page.

GRINDING CONTROL PROGRAMMING

The Program Vip Plus model is provided with an electronic system able to detect delivery parameter variations dependent on how coarse or fine the coffee powder is.

- The display will read:



- By pressing the **ENTER** key the display will read:



and in the line below, the current setting





Use the ▼ ▲ keys to change the settings; use the **RESET** key to quit the function without confirming, or press the key **ENTER** to confirm.

If the delivery time display reads:



then the sub-page for grinding control values is skipped, to pass directly to the following page:



If the delivery time display is on when a delivery is started - unless with the Continuous function - the bottom line of the display will show the delivery time (or times if more than one unit is delivering).

Each group has an area of the bottom line: the area on the left is for unit 1; the area alongside it is for unit 2 and so on, until the area on the far right, which is for unit 4.

The different areas are separated by vertical bars; if a group is not delivering, the area is empty.

Here below is an example: unit 1 is delivering (it has just started and 0 seconds have passed); unit 2 has been delivering for 12 seconds and unit 4 is delivering (it has been delivering for 21 seconds).

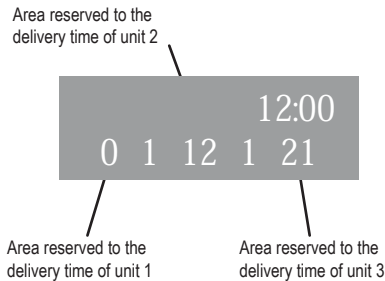

If the time is confirmed:



the machine passes to the grinding control value settings.

- By pressing the **ENTER** key the display will read:



where 00-40 indicates the maximum time (in seconds) allotted for the delivery of a sample amount of coffee, equal to 10cc for a single coffee and 30cc for a double coffee.

The first value will begin to flash on and off; modify by using the ▼ ▲ keys.

To confirm press the **ENTER** key.

- Press the **ENTER** key again to go on to the next value.
To modify the previous value, proceed as described above.

⚠ NOTE

If the system detects a delivery time (of the sampled amount) inferior to the programmed minimum, the display will read:



(See chapter called "MACHINE FUNCTION MESSAGES") which means you have to adjust the coffee grinder to reduce the grain.

If the system detects a delivery time (of the sampled amount) superior to the programmed maximum, the display will read:



(See chapter called "MACHINE FUNCTION MESSAGES") which means you have to adjust the coffee grinder to increase the grain. By setting the values at 00-40, the function is excluded.

- On completion press **ENTER** to go on to the next page.

HISTORICAL ALARM VISUALISATION

- The display will read:

- By pressing the **ENTER**, key, the display will read:



- Pressing the **▼** key, allows you to scroll down the ten previous alarms saved in the memory. After the tenth alarm, by pressing the **▼** key again you can go on to the next page.

MAINTENANCE PROGRAMMING

- The display will read:



By pressing the **ENTER** key, the display will read:



- Use the **▼ ▲** keys to set both values.
- Use the **ENTER** key to confirm.
Once the set delivery limit or the set maintenance date have been reached, the display will visualize the message:





Insert the "U" key (see chapter "USE") and set the display back to zero by pressing the **RESET** key. To go on to the next page, press the **▼** key.

SELECTING THE DESIRED LANGUAGE



- The display will read:

- Press the **ENTER**, key to visualise the language already set. Choose the desired language by using the ▼ ▲ keys.
- To confirm press **ENTER**.

TEMPERATURE UNITY MEASURE SELECTION

- The display reads:

- By pressing **ENTER**, the display will read:

CELSIUS
or
FAHRENEIT

- Press ▼ ▲ to modify the measures unit setted.
- Press **ENTER** to confirm.

KEYBOARD LIGHTING ADJUSTMENT

- The display reads:

- By pressing **ENTER**, key, the display will read:

DISPLAY X
Y
- With the KEYS light X blinking. Select the value of desired brightness choosing from a minimum value of 1 to a maximum of 6 by using ▼ ▲ keys.
- Confirm by pressing **ENTER**.

- The temperature DISPLAY value Y blinks and ▼ ▲ keys it is possible to set the display lighting Y from a minimum value of 1 to a maximum of 3.
- Confirm by pressing **ENTER**.
- The display will visualize the message:

8. CLEANING AND MAINTENANCE

8.1 SWITCHING OFF THE MACHINE

To switch the machine off press the main switch and set the machine to the "O" energy position.

8.2 CLEANING THE OUTSIDE OF THE MACHINE

Before carrying out any cleaning operations, set the machine to the "O" energy level, (machine switched off and plug removed from the mains).

⚠ WARNING

Do not use solvents, chlorine-based products or abrasives.

Cleaning the work area: remove the worktop, lifting it up from the front and sliding it out. Remove the water

collection dish underneath and clean everything with hot water and cleansers.

Cleaning the bottom: To clean all the chromium-plated areas, use a soft, damp cloth.

8.3 CLEANING THE STAINLESS COFFEE-HOLDERS

The stainless coffee-holders are situated under the delivery units, as shown in **Fig. 23**.

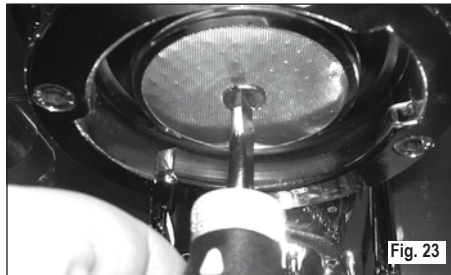

⚠ NOTE

To clean proceed as follows:

- Turn the screw placed in the centre of the coffee-holder.
- Slide the coffee-holder out and check that its holes are not obstructed but clean.
- If obstructed, clean as described (Paragraph "CLEANING FILTERS AND FILTER-HOLDERS"). We recommend cleaning the coffee-holder once a week.

8.4 CLEANING THE UNIT WITH THE AID OF THE BLIND FILTER

The machine is pre-set for cleaning the delivery unit with a specific washing powder.

The machine will initiate washing cycle which consists in the circulation of hot water followed by regular breaks.

We recommend carrying out a washing cycle at least once a day with special cleansers.

⚠ CAUTION RISK OF INTOXICATION

Once the filter-holder has been removed, repeat delivery operations a few times to eliminate any cleanser residues.

To carry out the washing procedure, proceed as follows:

- ① Substitute the filter with the delivery unit blind filter.
- ② Fill it with two spoonfuls of special cleanser powder and insert it into the unit filter-holder.

- ③ Press one of the coffee keys and halt it after 10 seconds.
- ④ Repeat the procedure several times.
- ⑤ Remove the filter-holder and carry out a few deliveries.

8.5 CLEANING FILTERS AND FILTER-HOLDERS

Place two spoonfuls of special cleanser in half a litre of hot water and immerse filter and filter-holder (without its handle) in it leaving them to soak for at least half an hour. Then rinse abundantly with running water.

9. ADONIS MACHINE FUNCTION MESSAGES

DISPLAY AND KEY INDICATIONS	CAUSE	EFFECT	SOLUTION	NOTES
DIAGNOSIS OF ERROR	At the time of the diagnosis the system presents faults within the control unit EPROM.	If after 90 sec of machine functioning the water level is not re-established.		
DELIVERY ERROR	On reaching delivery time limit (120 seconds) the doser doesn't send out its set commands.	The display indicator and the 'continuous' key belonging to the relative unit will flash on and off.	Press the RESET key or one of the keys ▼ ▲.	
DOSER ERROR	If the doser doesn't send out its set commands within the first three seconds from delivery onset.	If the delivery isn't manually halted, the maximum time limit (120 sec) will be blocked.	Press the RESET key or one of the keys ▼ ▲.	
LEVEL ERROR	If after 90 sec of machine functioning the water level is not re-established.	The display indicator will flash on and off. The pump is de-activated. The resistor and all the functions are halted.	Turn the machine off and then turn it on again. All its functions will be re-activated.	

DISPLAY AND KEY INDICATIONS	CAUSE	EFFECT	SOLUTION	NOTES
PRESSURE ERROR	When the machine's temperature is higher than 130°C.	The display indicator will flash on and off and the resistor is de-activated.	The system will be re-established as soon as the temperature goes below 130°C.	The boiler is provided with a manual refitting safety thermostat; if the resistor is not re-established, call a qualified technician.
OVERCURRENT ERR.	Incorrect electrical input caused by a malfunction in one of the machine charges.	The display reading will flash. The pump will switch off. The heating element and all other functions will be disabled.	Switch off the machine and send for a specialist technical engineer.	
FINE GRINDING	The machine registers values different from the set values.	A much longer delivery time.	Modify grinding degree and press the key RESET or one of the keys ▼ ▲.	By leaving the machine in the programming state, within 10 minutes from the last selection, the system will return to the previous configuration and the display will indicate its reestablishment of normal functioning.
COARSE GRINDING	The machine registers values different from the set values.	A much shorter delivery time.	Press the RESET key or one of the keys ▼ ▲.	

Victoria Arduino

The logo features the brand name "Victoria Arduino" in a white, elegant script font. Below the text is a white decorative flourish consisting of a central downward-pointing chevron shape with two long, thin, upward-pointing wings extending outwards.

Victoria Arduino Via Madonna d'Antegiano, 6 • 62020 Belforte del Chienti (MC) • Italy
T +39-0733-950243 • F +39-0733-950247 • Videoconf +39-0733-950201 • info@victoriaarduino.com • www.victoriaarduino.com