



**CANADA  
2023**

# Manhole Covers



# VODALAND today

Established in 2000, Vodaland is an international manufacturer and supplier specializing in the fields of water collection and removal, custom project engineering, and terrain development.

**7** countries  
USA, Canada, France, Spain, Poland, Romania, Ukraine



|                               |                            |   |                                   |                             |   |
|-------------------------------|----------------------------|---|-----------------------------------|-----------------------------|---|
| <b>4</b><br>Production Plants | <b>11</b><br>Sales offices | <b>ISO</b><br>certified according to ISO 9001 | <b>R&amp;D</b><br>own service R&D | <b>i</b><br>Project Service | <b>350</b><br>international team of workers |
|-------------------------------|----------------------------|---|-----------------------------------|-----------------------------|---|

## Categories



- ✓ Trench Drains
- ✓ Slot drains
- ✓ Industrial Drains
- ✓ Catch Basins



- ✓ Oil/water separators



- ✓ Erosion Control Grids
- ✓ Plastic Paving Grids



- ✓ Manhole Covers
- ✓ Garden Border/Edging

# Product Title Terminology

| Series                  |  |
|-------------------------|--|
| <b>BASE</b>             | Classified as load classes A-C                       |
| <b>PRO</b>              | Classified as load classes D-E                       |
| <b>MEGA</b>             | Classified as load classes D-F                       |
| Product Lines           |  |
| <b>Concrete</b>         | Product made of Fiber Concrete material              |
| <b>Polymer concrete</b> | Product made of Polymer Concrete material            |
| <b>Plastic</b>          | Product made of PPE Plastic material                 |
| <b>STAINLESS</b>        | Fully Stainless Steel system                         |
| Width                   |  |
| <b>Inches</b>           | The inches in product title refers to internal width |

## Series explanation



**BASE series:**  
**Load Class A15-C250**  
Small & medium loads, being ideal for residential areas and light commercial application.



**PRO series:**  
**Load Class D400-E600**  
Medium & heavy-duty loads such as gas stations, parking garages, warehouses & forklifts, and curbsides.









**MEGA series:**  
**Load Class D400-F900**  
Used for heavy duty & extreme loads such as heavy traffic roads & highways, industrial zones, and airports.

URBAN

# Load Classifications

Load classifications have been done according to EN 1433; the only standard written specifically for grated trench drains, and internationally recognized.

Each item is designed for a specific load class. The load classes will aid you in choosing the right channels and Grates in accordance with the requirements of your construction project.

|             |   |                         |  |
|-------------|---|-------------------------|--|
| EASY Series |    | A 15<br>(3,300 lbs.)    | Pedestrians, bicycles and wheel chair traffic. Pedestrian zones, parks, recreation areas, stadiums etc.                        |
|             |    | B 125<br>(27,500 lbs.)  | Medium-duty pneumatic tire traffic, autos and light trucks at speeds less than 20 m.p.h. Residential areas, parking lots, etc. |
|             |   | C 250<br>(55,000 lbs.)  | Heavy-duty pneumatic tire forklifts, tractor-trailers, buses. Road shoulders, auto services, garages, etc.                     |
| PRO Series  |  | D 400<br>(88,000 lbs.)  | Heavy-duty hard tire forklifts, trucks. Gas stations, car washes, industrial areas, warehouses, etc.                           |
|             |  | E 600<br>(132,000 lbs.) | General dock and aircraft pavements.   |
|             |  | F 900<br>(198,000 lbs.) | General docks and aircraft pavements subject to high wheel loads.  |

# Type of Surface Drainage

**Linear Drainage Systems** are used to collect storm-water and melted snow from a large area.



Linear and Point Drainage Systems are both used in storm-water removal and distribution, each with their own function and purpose. The linear channels collect and drain water from the surface, providing safety for road surfaces and pedestrian traffic.

**Point Drainage Systems** are used for local collection of storm-water and snowmelt.



Point drainage systems perform the function of collecting water at a center point. Our catch basins and inline inline catch basins are equipped with a basket to catch debris and sand, preventing excess sediments going into the system.

## CONTENTS

### URBAN

#### Manhole Covers

Plastic Manholes .....6  
 Polymer-sand manholes.....8



# Manholes

## Plastic Manholes

Our Plastic Manhole Covers have a very aesthetic and unique design. They are color stable, they do not corrode, and have a UV protection made from sustainable polypropylene. These Manhole Covers are not heavy like the traditional ones, and have a fastening system that prevents theft and trespassing. This manhole cover is the clear choice of the future.



### KEY BENEFITS

- The ideal ratio of aesthetic and durability for manholes
- The lid will lock at the open position when at an angle of 105° (lid does not have to be taken off)
- If necessary, the manhole lid is also fully removable
- Manhole can be locked shut by bold and nutGrass Installs



## Manhole Cover - Square

| Square Manhole plastic with lock |                   |
|----------------------------------|-------------------|
| Dimensions (external)            | 27.6" (700mm)     |
| Dimensions (internal)            | 22" (560mm)       |
| Height                           | 3.2" (80mm)       |
| Load Class                       | A15 - 3,300 LBS   |
| Weight                           | 17.3 LBS          |
| Article                          | 35487-247 (grey)  |
| Article                          | 35487-207 (black) |
| Article                          | 35487-227 (green) |

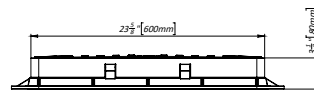
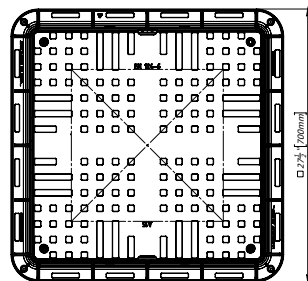

## Manhole Covers - Round

Our manhole covers are fantastic looking and fully reliable. Made from a high composite PPE Plastic, they are A load class rated. This is due to the steel bar reinforcement found within the manhole that are also removable to allow access into the covered space. The bolted lock mechanism prevents unwanted visitors and provides additionally security against harsh weather. This continues to be one of our top sellers as it is a one-of-a-kind product only made here at Vodaland.



### KEY BENEFITS

- Angle 5°-15° - allows you to remove the manhole cover
- Angle 90° - fixing the lid in the open position, prevents the manhole from being closed involuntarily
- Angle 110° - open position
- Angle 90° - fixing the lid in the open position, prevents the manhole from being closed involuntarily, to close the lid it should be lifted
- Angle 0° - closed position, can be further fixed with a bolt

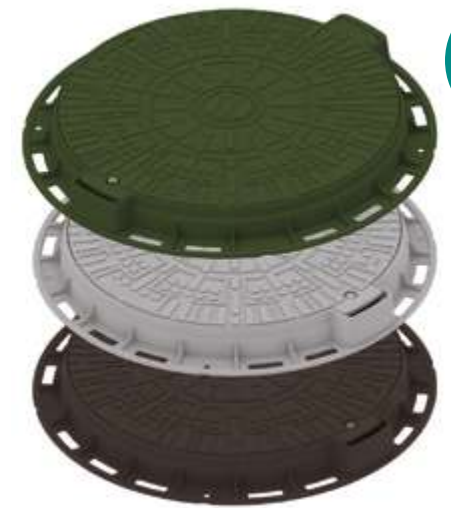

| Round manhole plastic with lock |                   |
|---------------------------------|-------------------|
| Dimensions (external)           | 31.5" (800mm)     |
| Dimensions (internal)           | 23.8" (605mm)     |
| Height                          | 3.2" (82mm)       |
| Load Class                      | A15 - 3,300 LBS   |
| Weight                          | 17 LBS            |
| Article                         | 35288-207 (black) |
| Article                         | 35288-227 (green) |
| Article                         | 35288-247 (grey)  |

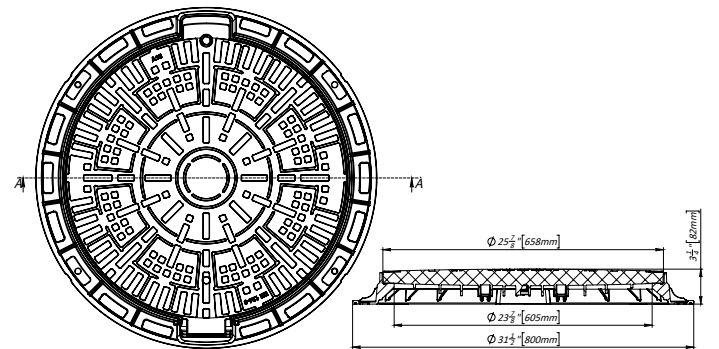

### Polymer-sand manholes

We also create manholes of polymer-sand composition - it is the latest development, created as an alternative to cast-iron manholes. These products are manufactured to take into account safety and environmental standards, meeting all the requirements of the modern industry.



#### KEY BENEFITS

- Resistance to Temperature**  
 Can retain all of its properties within the range of -60deg to +60deg C
- Low Cost**  
 Much lower pricewise in comparison to the cast iron and concrete counterparts
- Aesthetic Look**  
 Visually appealing patterns and blends well with the surrounding environment
- Color Options**  
 Due to the many different color choices, you can find a manhole cover to best match your situation
- Lightweight**  
 The weight of these manholes means it does not require more than one person for both installation and opening/closing.
- Color-loss Prevention.**  
 The manhole is painted in a uniform thickness with heat-resistant paints resulting in no risk of color-loss over time.



A 15

Our new Polymer sand manhole is perfect for pedestrian only traffic and blends in with the rest of your landscape. It's made of composite sand/polymer plastic. Lifts up and seals easily. Will withstand long lasting UV rays and looks great.

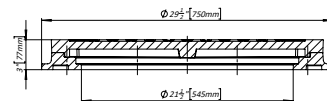
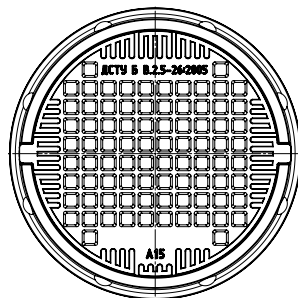

| Polymer sand manhole  |                  |
|-----------------------|------------------|
| Dimensions (external) | 29.5" (750mm)    |
| Dimensions (internal) | 21.5" (545mm)    |
| Cover thickness       | 1.8" (45mm)      |
| Height                | 3" (77mm)        |
| Load Class            | A15 - 3,300 LBS  |
| Weight                | 55.1 LBS         |
| Article               | 30298-30 (black) |



B 125

| Polymer sand manhole (medium duty) |                   |
|------------------------------------|-------------------|
| Dimensions (external)              | 30.3" (770mm)     |
| Dimensions (internal)              | 22" (561mm)       |
| Cover thickness                    | 1.6" (40mm)       |
| Height                             | 3.6" (91mm)       |
| Load Class                         | B125 - 28,100 LBS |
| Weight                             | 79.4 LBS          |
| Article                            | 30298-40 (black)  |

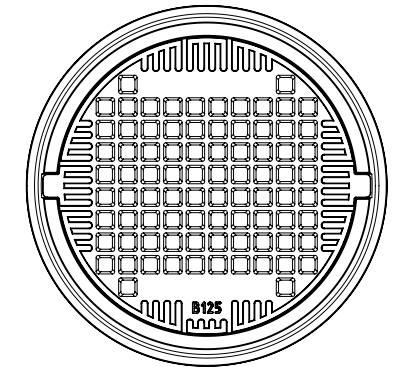
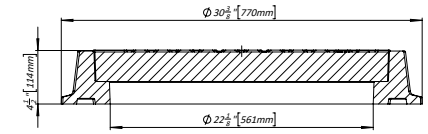

C 250

| Polymer sand manhole (heavy duty) |                   |
|-----------------------------------|-------------------|
| Dimensions (external)             | 30.3" (770mm)     |
| Dimensions (internal)             | 22.4" (570mm)     |
| Cover thickness                   | 2.6" (67mm)       |
| Height                            | 4.6" (117mm)      |
| Load Class                        | C250 - 56,200 LBS |
| Weight                            | 110.2 LBS         |
| Article                           | 30298-50 (black)  |

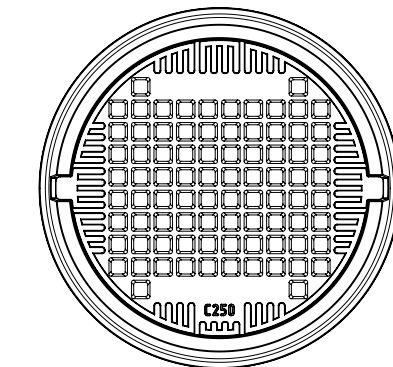
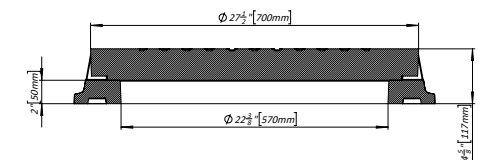



Vodaland Canada Inc.  
5900 Ambler Drive, Unit 1 & 2, Mississauga, ON L4W 2N3  
+1 (905) 238 1771

[VODALAND.CA](http://VODALAND.CA)

