

8" Plastic Channel

Primary Usage

Reference No.

Sign. and date

Copy inv. No.

Repl. Inv. No.

Sign. and date

Orig. Inv. No.

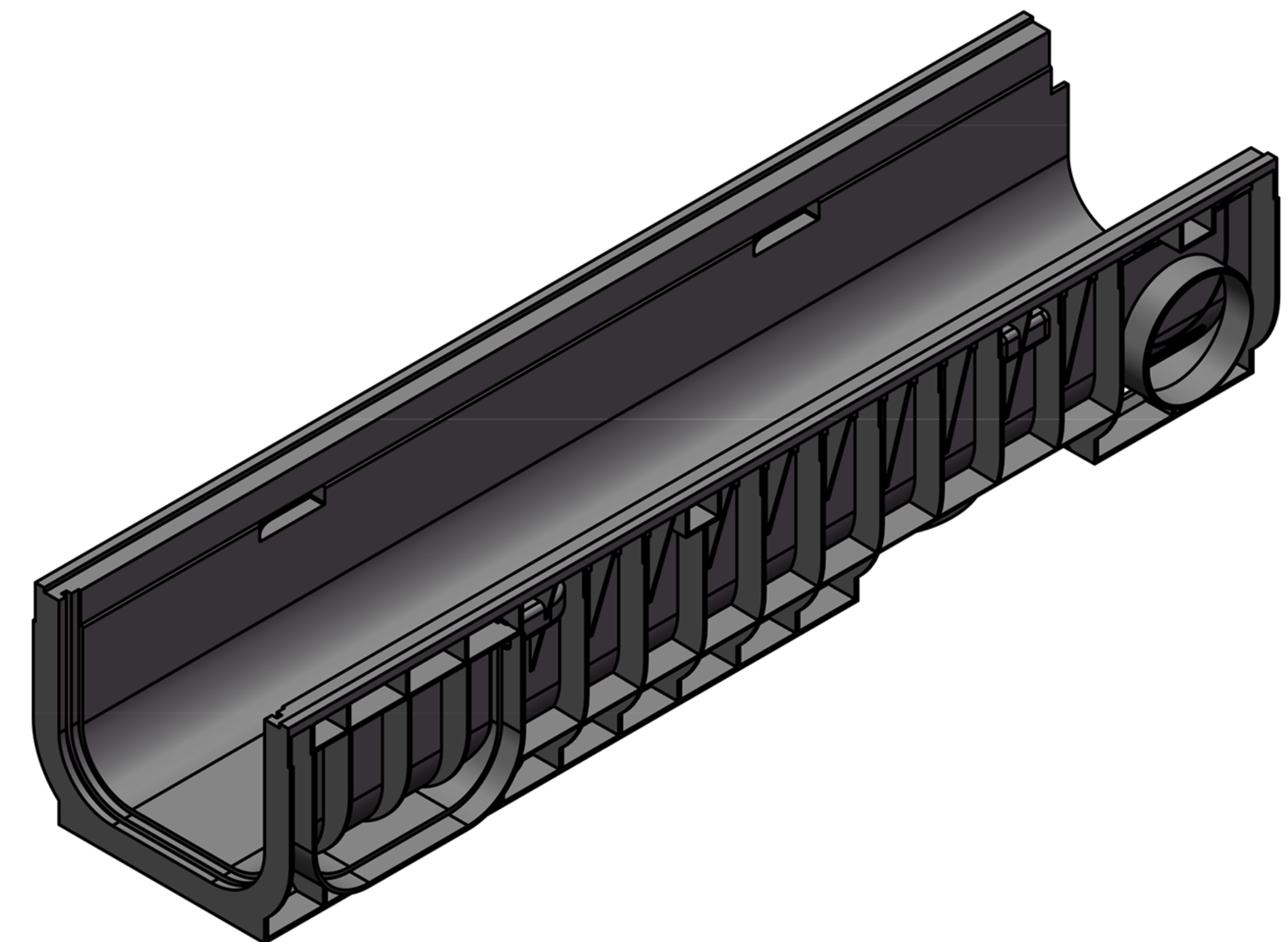
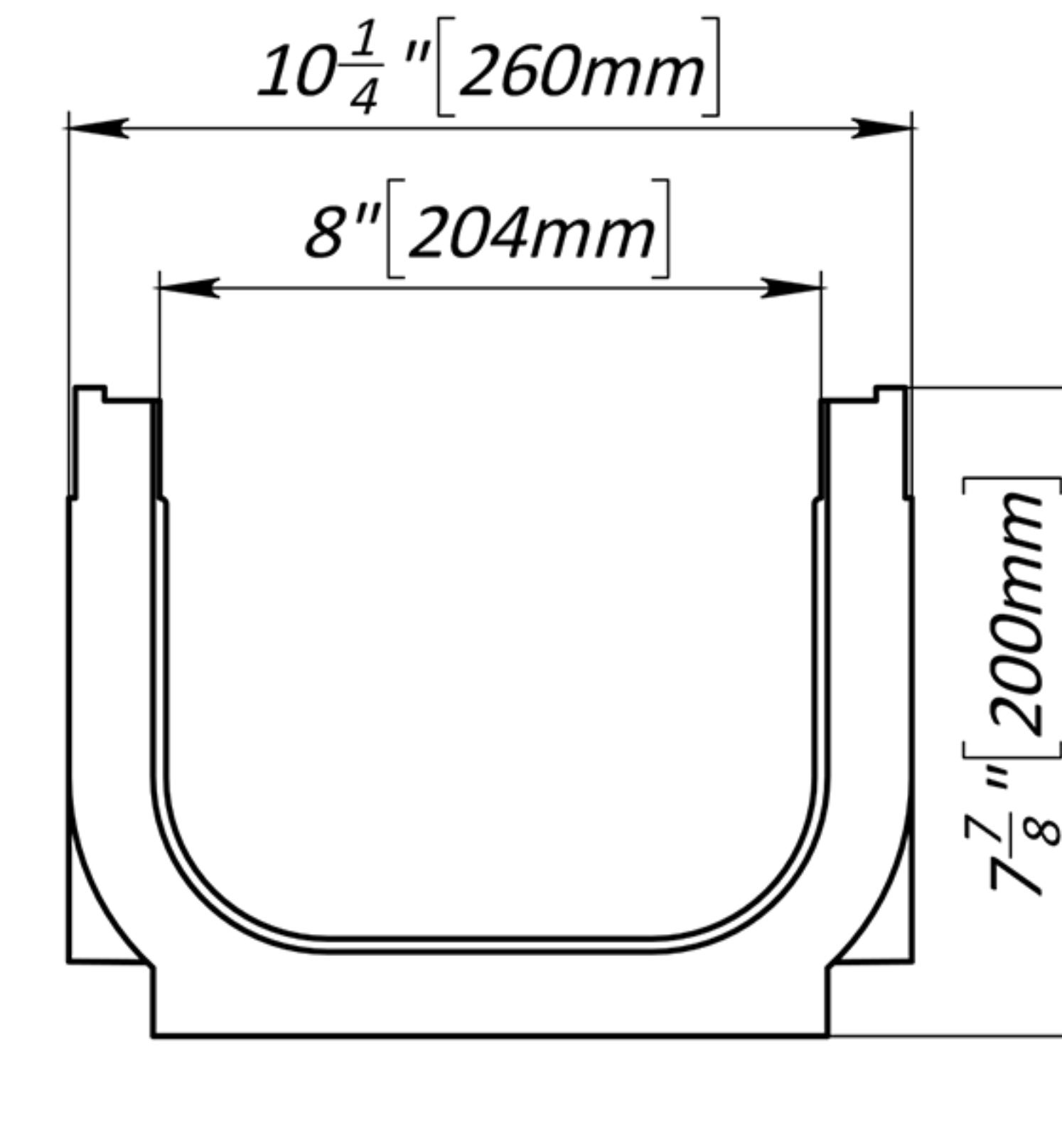
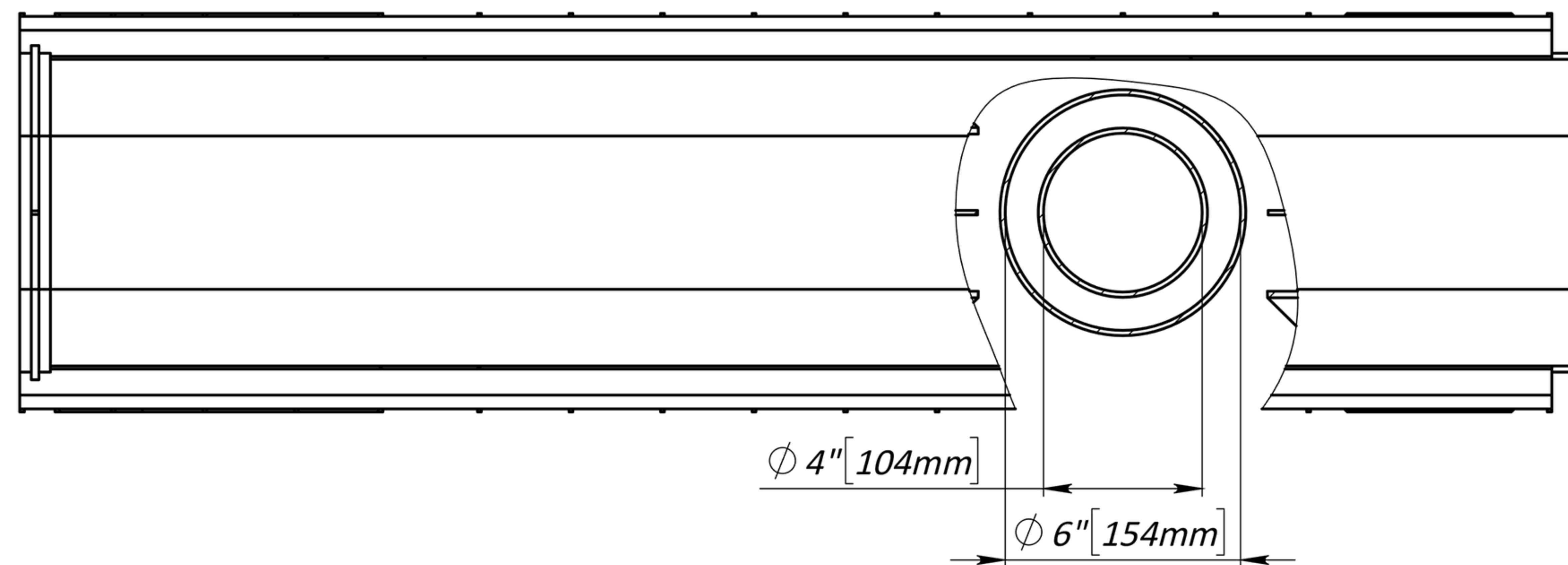
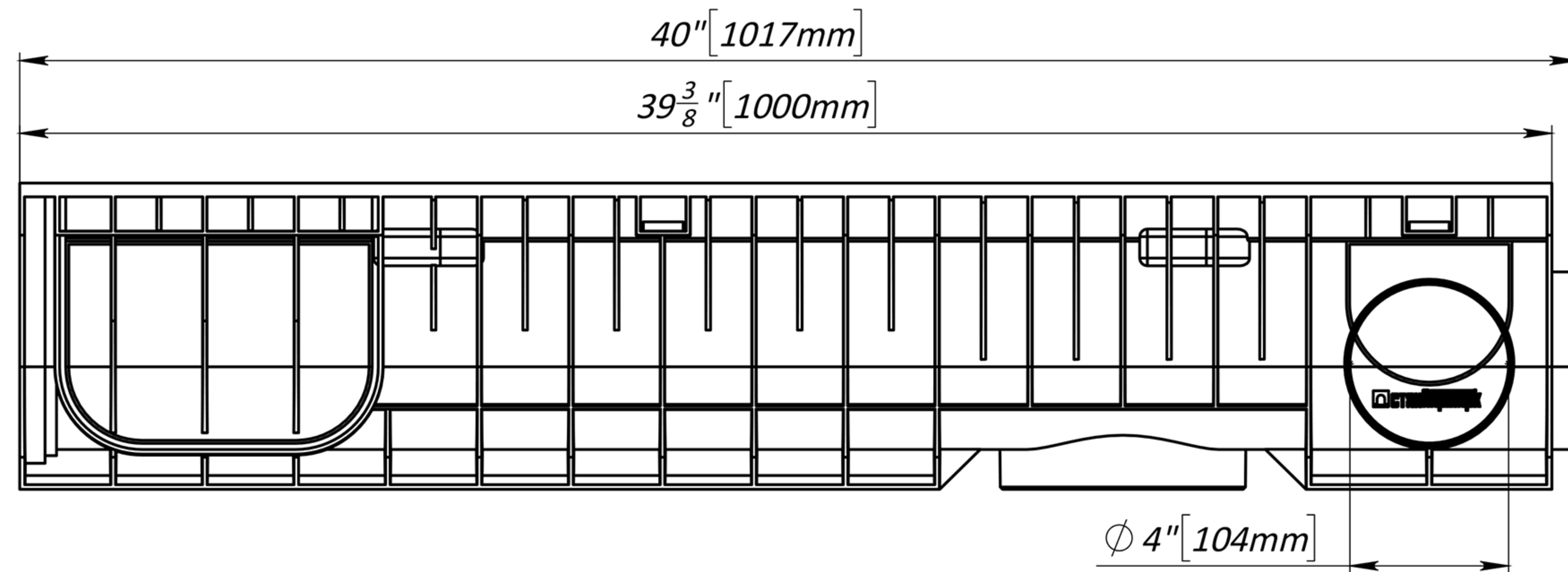

Deviation of the actual weight of the nominal can be up to 10%

				Art. 8540			
				8" Plastic Channel			
Rev.	Sheet	Doc. No.	Sign.	Data	Let.	Weight (lb)	Scale
				11.09.18		7.24	1:5
					Sheet		Sheets 1
					Plastic		STANDARTPARK®