

MAGNUSON

SUPERCHARGERS

Installation Instructions for: 2021-2023 Jeep Rubicon 392



PREMIUM 91 OCTANE GASOLINE FUEL REQUIRED



ATTENTION!
Your **MAGNUSON SUPERCHARGER** kit
is sensitive to corrosion!
Use **only** the vehicle manufacturer
recommended coolant for your engine in
the intercooler system as well.

Magnuson Superchargers
1990 Knoll Drive, Bldg A, Ventura, CA 93003
(805) 642-8833 phone
magnusonsuperchargers.com

INSTALLATION MANUAL

Magnuson Supercharger Kit: 2021-2023 Jeep Rubicon 392

Please take a few moments to review this manual thoroughly before you begin work: Make a quick parts check to be certain your kit is complete (see Bill of Material (BOM) parts list inside the accessory box). If you discover shipping damage or shortage, please call our office immediately. Take a look at exactly what you are going to need in terms of tools, time, and experience. Review our limited warranty with care.

Use only premium gasoline fuel, 91 octane or better. The use of non-premium fuel can cause engine failure and will void your warranty.

Magnuson Products recommend that you run a minimum of one tank of premium 91 octane or better fuel through your vehicle prior to installation of the system to prevent any possible damage that may occur due to running the supercharged engine on lower octane fuel.

DO NOT RUN E85 FUEL WITH THE SUPERCHARGER.

DO NOT USE OCTANE BOOSTERS. If you have used octane boosters in the past you will have to replace your spark plugs and the O2 sensors.

Magnuson Superchargers systems are designed for engines and vehicles in “GOOD” mechanical condition. Magnuson Superchargers recommend that a basic engine system “Health Check” be performed prior to the installation of this supercharger system. Be sure to check for any pending or actual OBDII codes and fix/repair any of the stock systems/components causing these codes. If there are codes prior to the installation they will be there after the installation.

Magnuson Superchargers also recommend the following services to be performed on your vehicle while installing the supercharger system:

- Fuel Filter change
- Engine oil and filter change using brand name oil (organic or synthetic) and filter
Note: It is VERY IMPORTANT to use the factory specified oil viscosity. The original equipment manufacturer has selected this grade of oil to work with your other engine systems such as hydraulic chain tensioner and variable cam controls. Deviation from this specification may cause these systems to fail or not function properly. Please refer to your owner’s manual for the recommended oil viscosity or your engine and application.

On older vehicles Magnuson Superchargers recommend these additional services to be performed:

- Coolant system pressure test and flush.
NOTE: YOU MUST USE JEEP SPECIFIED COOLANT MIXTURE!

Non “Magnuson Superchargers Approved” calibrations or “tuning” will Void ALL warranties and CARB certification.

Our supplied calibration is designed for use with the components provided in this kit. Any adjustment to the intake, or exhaust systems or other engine components may adversely affect engine performance and may trigger your check engine light.

Tools Required

- Metric wrench set**
- Metric 3/8" and 1/2" drive metric socket set (standard & deep)**
- 3/8" and 1/2" drive ft-lbs. and in-lbs. torque wrenches**
- Metric Allen socket set 3/8 drive**
- Metric Allen wrenches**
- Phillips and flat head screwdrivers**
- Serpentine belt tool**
- Funnel**
- Drain pan**
- Hose cutters**
- Hose clamp pliers**
- Safety glasses**
- Nut driver**
- Compressed air**
- Air gun**
- Heat gun**
- Torx socket set 3/8 drive**

Contact Information:

Magnuson Superchargers
1990 Knoll Drive, Bldg A
Ventura, CA 93003

Sales/Technical Support Line: (805) 642-8833
Websites: www.magnusonsuperchargers.com
Email: sales@magnusonsuperchargers.com

Table of Contents

Section 1: Initial Preparation	5
Section 2: Disassembly	7
Section 3: Crank Pinning	17
Section 4: Low Temperature Radiator (LTR) Install	20
Section 5: Intercooler Pump Install	25
Section 6: PCV Oil Separator Install	30
Section 7: Intercooler Pump Relay Wiring	30
Section 8: Coolant Reservoir Relocation	34
Section 9: FEAD Bracket Sub-Assembly	36
Section 10: Supercharger Preparation	39
Section 11: Coolant Reservoir Bracket Modification	44
Section 12: Hose Routing	51
Section 13: Oil Separator Hose Routing	52
Section 14: Intercooler System Hoses	55
Section 15: Engine Radiator and Intercooler System Filling	62
Section 16: Final Testing	64
Section 17: Hydro Guide Modification	65

Any reference to the left or right side of the vehicle is given from the driver's seat perspective.

Section 1: Initial Preparation

1. Before beginning the installation run a full tank of premium 91 octane or higher fuel through your engine. **DO NOT USE E85 FUEL OR OCTANE BOOSTER!** The vehicle must have premium fuel prior to starting the install.
2. If your kit has a provided handheld tuner follow the instructions in the provided pamphlet to install your tune. **WARNING: DO NOT BEGIN THE INSTALLATION BEFORE OBTAINING YOUR NEW CALIBRATION FILE. IN SOME CASES, ESPECIALLY WITH NEWER VEHICLES, THIS STEP CAN TAKE SEVERAL DAYS AND YOUR VEHICLE WILL BE IMMOBILIZED WHILE YOU WAIT FOR THE NEW CALIBRATION FILE.** The pictures shown may be slightly different from the items you receive.
3. **Do Not** remove your PCM until you are instructed to in a later step. If you purchased the kit without calibration you can disregard this step. If your kit has a PCM shipper box and HP Tuners RTD device you will mail in your PCM for unlock to the address shown in the RTD Flash Tool Instructions. Detailed instructions will be provided in a later step for removing the PCM from your vehicle.
4. Remove the fuel pump relay from the under hood fuse panel shown here with the green arrow. Start the vehicle to release pressure from the fuel rail/line prior to disassembly. Once you have purged the fuel pressure you can replace the fuel pump relay. (Fuel pump relay location: K02)

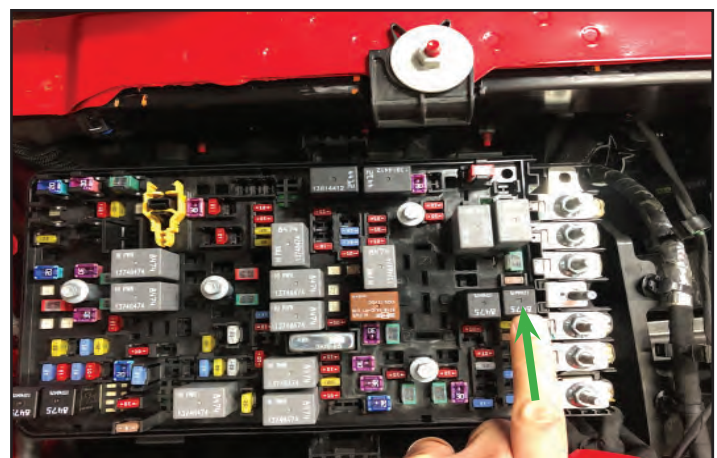

5. Disconnect the ground post on the battery (10mm socket) Cover the terminal end with tape or a rag.



6. **If you are not providing your own calibration you will need to send in your PCM for unlock. There is a box provided for sending in your PCM with instructions included.**

Using a 10mm socket, loosen and remove the 3 nuts at the arrow locations holding the PCM in place. Note that there is a ground strap attached at the upper LH corner. Remove it from the stud.



7. Loosen and remove the two circled fasteners that secure the PCM bracket to the vehicle.

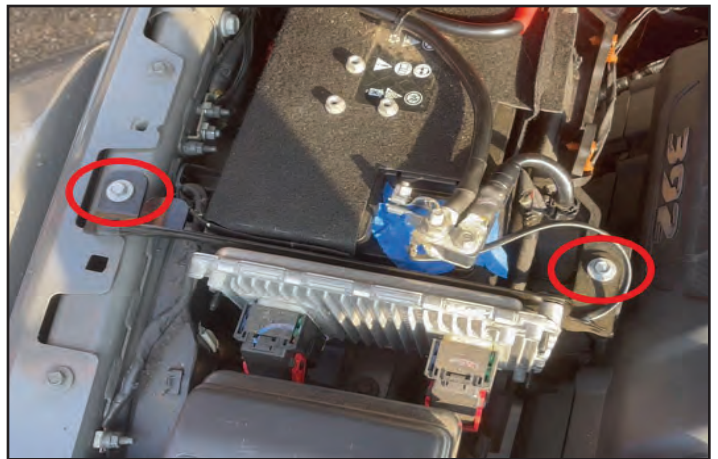

8. The front of the PCM bracket is secured at the base by a round stud. Lift the PCM up then remove the bracket from it and set it aside.



9. Hold the PCM up to gain access to the (2) electrical connectors on the front vertical face. Push in on the black locking tab (shown in the inset photo) with a finger then use your thumb to rotate the large red tab 90 degrees and release the connector from the PCM. Repeat the process for the second connector. The PCM can now be removed from the vehicle.



10. Remove the three nuts holding the PCM to its bracket and remove the bracket.

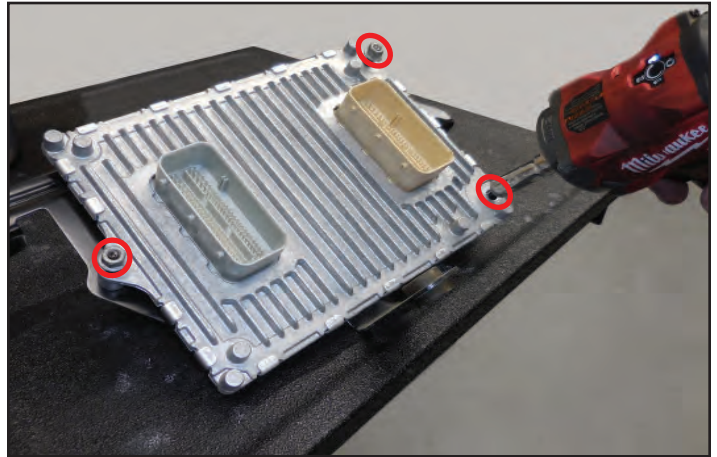

11. Place the PCM in the provided shipping box and follow the directions given in the RTD Flash Tool Instructions.



Section 2: Disassembly

12. Using proper push pin removal tools, carefully remove 6 push pins along the top core support/horse collar.

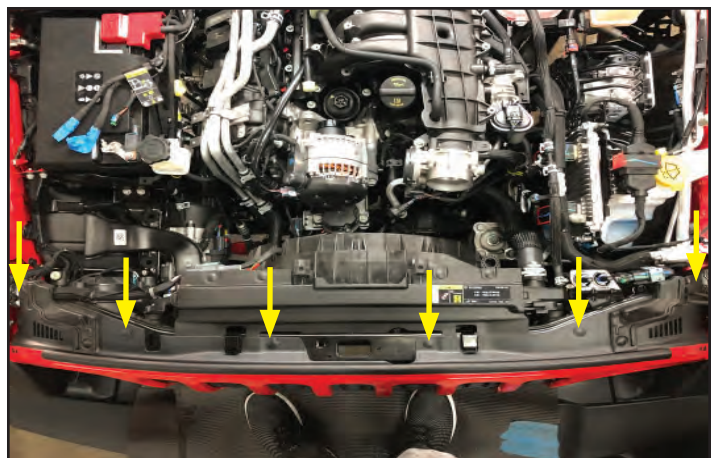

13. Use push pin pliers to remove the 6 push pins.



14. Pry the top core support/horse collars out with a trim removal tool.



15. Pry up on both ends to release the front grille locating pins.



16. Pull the top portion of the grill slightly away as shown here to access the lower retainer clips.

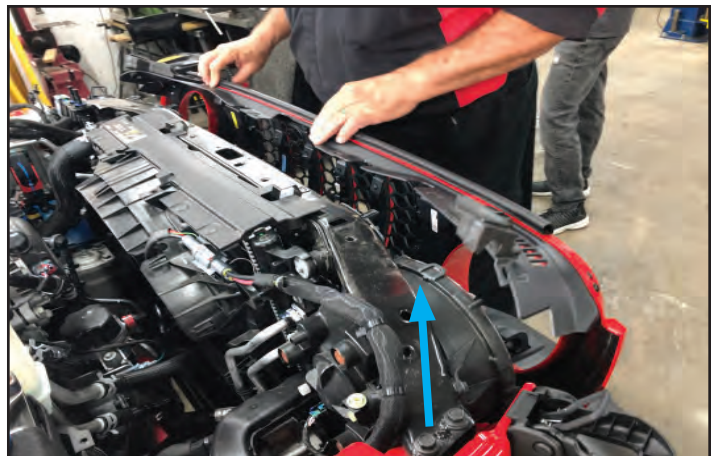

17. Once all push pins have been removed, use an 18" pry bar to carefully release 6 lower retainer clips. This pry bar has been highlighted in green here. The location of one lower clip is shown with an arrow.

Note: Front camera equipped Jeeps will have an added harness that disconnects near the driver's side headlight.



18. The arrows show 4 of the lower grill retainer clips, and once again the pry bar is highlighted in green.

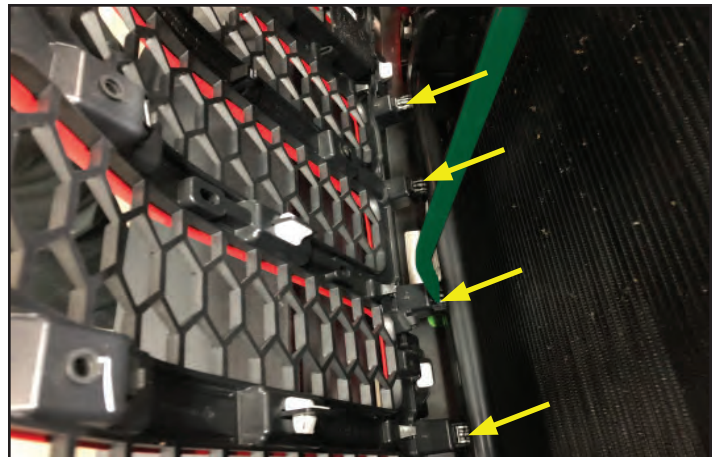

19. Remove front grille from vehicle to prevent damage during install and allow for installation of front radiator in a later step.



20. Remove the two engine covers shown if you have a 6.4L engine.

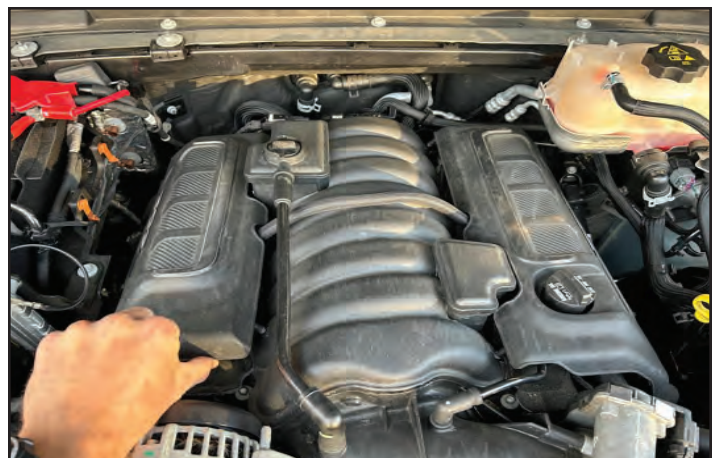

21. Using an 8 mm socket loosen the clamps on the clean air tube to the throttle body and airbox. Disconnect the IAT sensor from the clean air tube. Remove (3) wiring harness fir tree connectors from the tube and throttle body then remove the clean air tube from the vehicle.

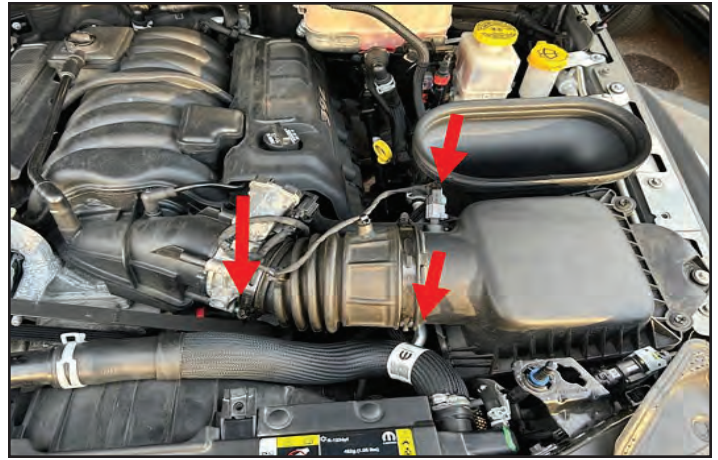

22. Using a 10mm socket remove the bolt holding the airbox in place. Disconnect the PCV fresh air tube from the intake by the oil fill, then lift up on the airbox and remove it from the vehicle.



23. Unplug the Electronic Throttle Control (ETC) from the throttle body. Pull back on the white locking tab first before you unplug this connector.



24. Unplug the eight fuel injector connections. You will need to pull out on the red locking tab to disengage it first. Then you can push on the black side button as you pull it out.



25. On the very back of the OEM intake manifold on the passenger side is the MAP sensor. Pull the lock and disconnect this plug and the mounting push pin clip as well.



26. Disconnect the EVAP hose from the front of the driver side of the intake manifold behind the throttle body. Pull the EVAP hose clips off from along the manifold.



Wear safety glasses while working with the fuel line. Place rags under the fuel connection to catch any fuel spills.

27. Remove the lock securing the fuel line by pulling up on the end as shown.



28. Use a fuel line disconnect tool to cycle the internal lock and allow the connector to release. Have paper towels or a rag ready to catch any fuel that drains out.



29. Remove the ten bolts holding the intake manifold to the heads with an 8mm socket wrench.



30. Pull the OEM intake manifold forward a bit to gain access to the brake booster hose plugged into the back of the manifold. Disconnect this hose from the rear of the intake manifold. There is also a wire loom clamp located at the back of the intake manifold that needs to be pulled free or cut off.



31. Cycle the red lock then squeeze the tab and pull on the connector to disconnect the IMRC valve wiring harness.

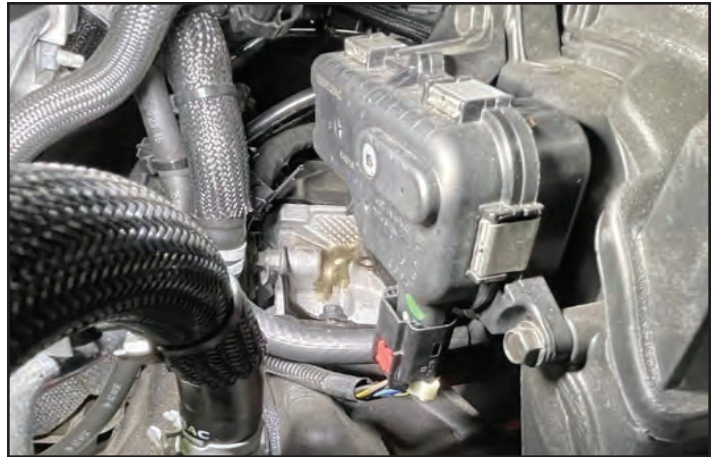

32. Carefully lift the OEM intake assembly from the vehicle.



33. Use a vacuum to remove any debris from the heads and adjacent surfaces. Be careful to not allow any debris into the open ports.



34. Wipe the port surfaces clean using a shop rag and alcohol (lacquer thinner, acetone or some other non-petroleum based solvent).

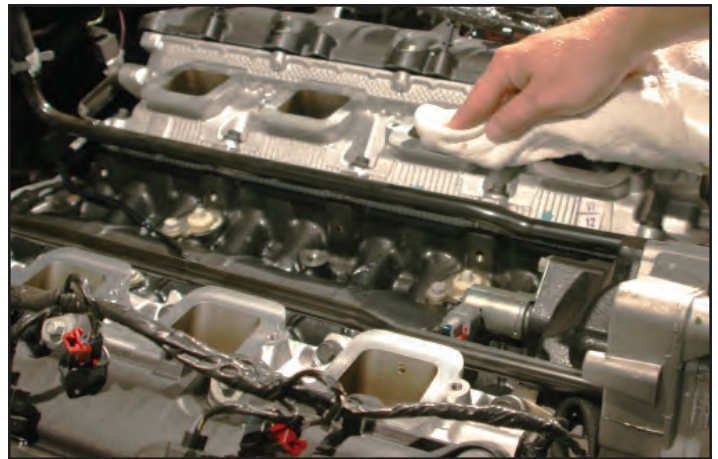

35. Use tape or shop rags to cover the exposed ports and prevent debris from entering the ports.



36. Remove the plastic wiring harness covers on the LH and RH sides of the engine (RH side shown highlighted in green). 4 zip ties per side secure the upper and lower halves of the covers. Cut the zip ties and remove the covers upper covers. You will need to remove the lower hard plastic cover as well. You will have to pull some fir tree connections and remove more cable ties to remove the lower covers.



37. Here are the upper and lower covers that were removed in the last step. They will not be reused.

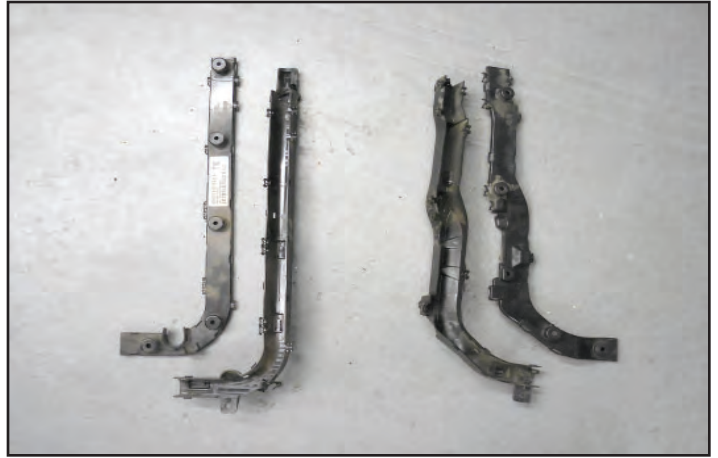

38. Use electrical tape to cover up the factory CMCV connector which was removed from the back of the OE intake manifold (red oval). This connector has four wires on it, and will not be re-used. The connector can be zip tied to any adjacent wire to keep it secure.

At this time you can also remove the 90 degree hose from the tee fitting (green oval). This will not be reused.

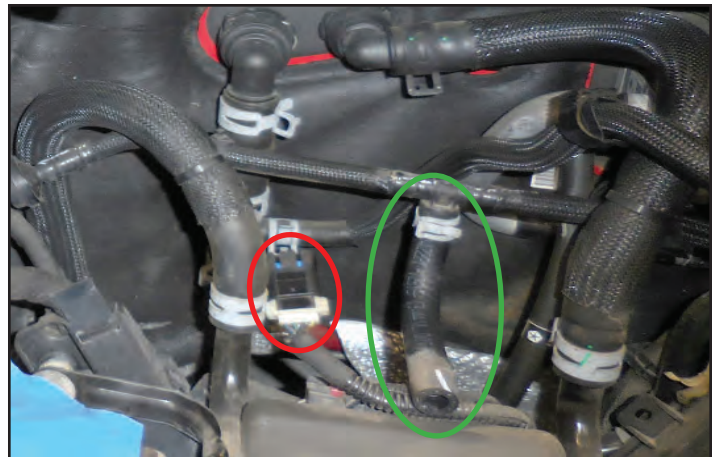

39. To facilitate the hose install, use a long 3/8" drive ratchet to spring the tensioner and remove the OEM fan belt. This belt will not be reused.



40. Remove the electrical connector on the back of the alternator. Using a 13mm socket remove the power cable from the alternator. Cover the wire end with tape.



41. Remove (3) 13mm fasteners securing the alternator to the bracket. Remove the alternator from the vehicle and set it aside.

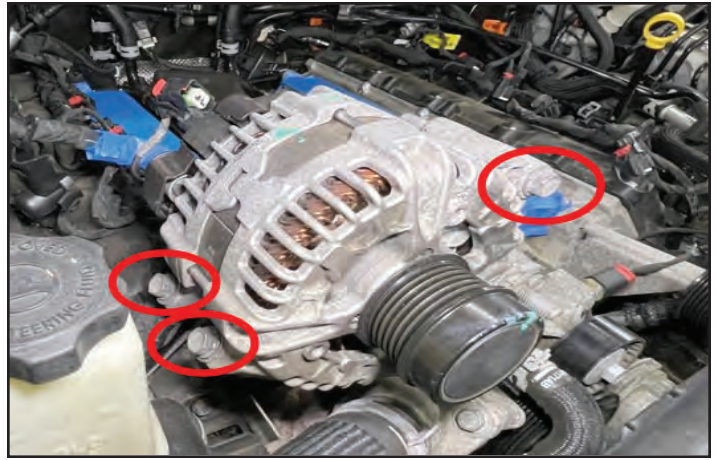

42. Remove the stud from the alternator bracket in the location shown with a 15mm socket. It will not be reused.



43. Remove the 4 bolts holding the alternator bracket to the front cover assembly. Remove the bracket from the vehicle and set it aside.

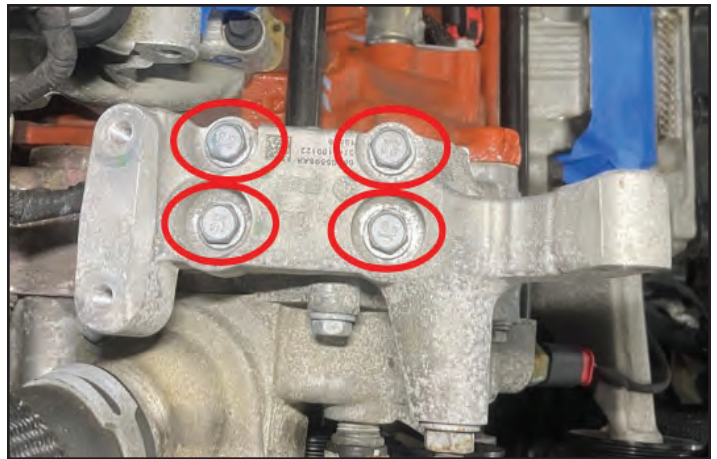

44. Slide the cooling fan connector toward the RH side of the vehicle to disengage it from the fan shroud. Push in on the lock and disconnect the fan hard-shell connector.



45. Remove the 2 bolts holding the fan shroud in place.

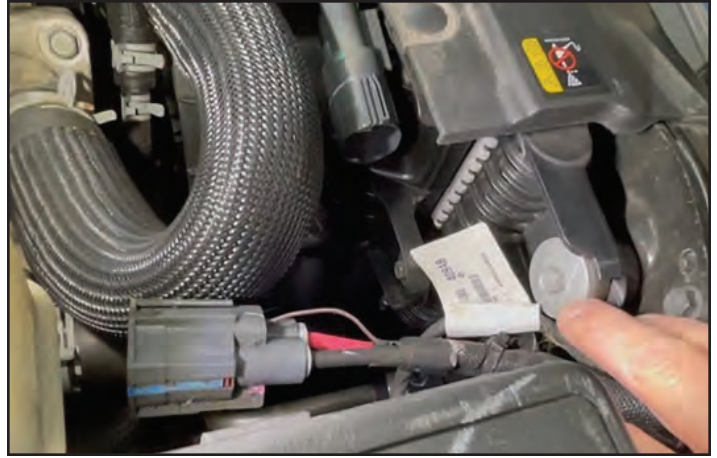

46. Hold the upper radiator hose back then lift the fan shroud out of the vehicle and set it aside.

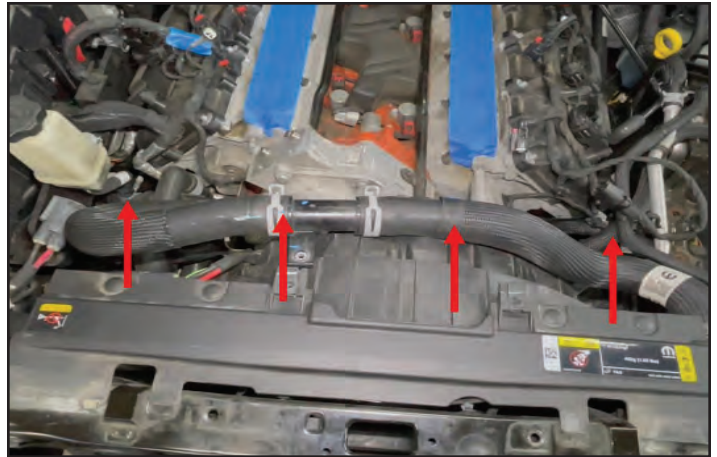

47. Here you can see the fan shroud removed from the vehicle.

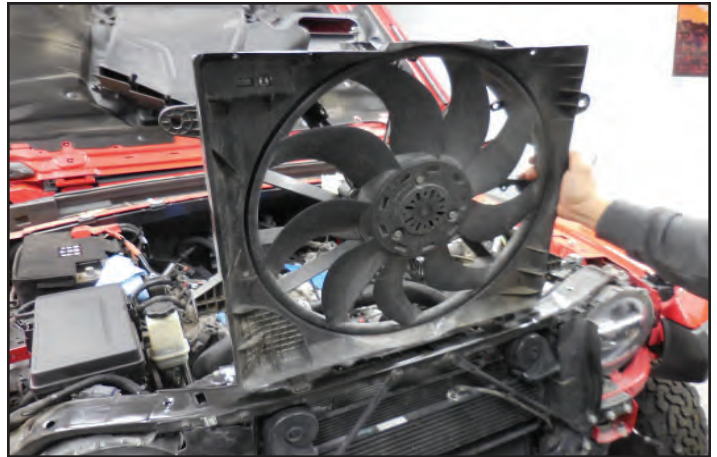

48. Locate the hose clamp adjacent to the thermostat housing in the location shown.



49. Using hose clamp pliers or needle nose pliers, spread the clamp and re-orient it counter-clockwise so that the tabs are located off to one side, and do not protrude above the top surface of the hose. This must be done to allow for serpentine belt clearance.

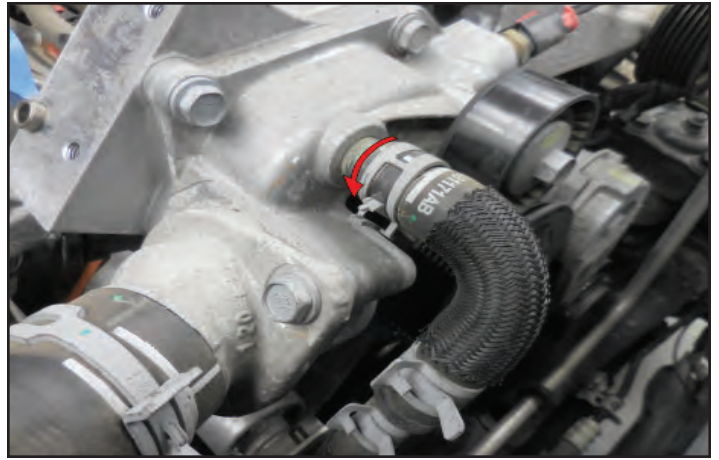

Section 3: Crank Pinning

50. Select the crank balancer pin installation kit PN 31-23-61-100. Follow the addendum instructions contained in the kit to pin the crankshaft.



51. Use a pry-bar or long heavy duty screwdriver to anchor the pulley using alternate sides of the dowels you push into the pulley holes as shown. This will give you a lever to stop the pulley from turning. Now, use a 21mm wrench to remove the crank harmonic balancer pulley bolt. Set aside for later use along with the two provided dowels.



52. Gather the provided crank pin drill guide and bolt. Install the bolt as shown with the stepped end of the drill guide towards the back.



53. Install the crank pin drill guide with the provided bolt and a 22mm wrench. It's convenient to align the two holes for the crank pins in the drill guide horizontally for ease of access. **Torque the temporary bolt holding the drill guide to 40 ft-lbs.**



Wear safety glasses for the drilling, reaming and compressed air steps.

54. Use the provided drill bit to drill the two holes using the pin guide holes. Before beginning, inspect the drill bit: You will notice there are two small 'steps' in the diameter of the bit. The second step, closest to the shank is your stopping point at the drill guide. If you put a piece of tape around the high point of that step you will have a visible stopping point as it touches the drill guide. Be sure to drill the holes completely to the second step of the drill bit.



55. Blow out the holes using compressed air. Use safety glasses and be careful of your eyes!



56. Install the provided reaming bit into the drill motor and ream the holes you just made.



57. When you're finished with the ream bit, blow the holes out again with compressed air watching out for your eyes.



58. Remove the drill guide kit using a 22mm wrench.



59. Gather the two provided crank pins.



60. **Put a generous bead of green Loctite 680 on the pins** and press one into each of the two holes you just prepared.



61. Use a hammer and drift-pin or nail-set to tap the crank pins in completely.



62. Ensure that they are in completely, and will not touch the surface of the crank bolt directly when installed.



63. **Re-install the removed OEM crank bolt and torque to 129 ft-lbs.** Verify your torque wrench settings. Use the two supplied dowels in two of the pulley face holes again as an anchor, and a 22mm wrench to tighten the pulley bolt.



Section 4: Low Temperature Radiator (LTR) Install

64. Remove 2 front pencil braces highlighted in green with T-30 torx socket (4 bolts).

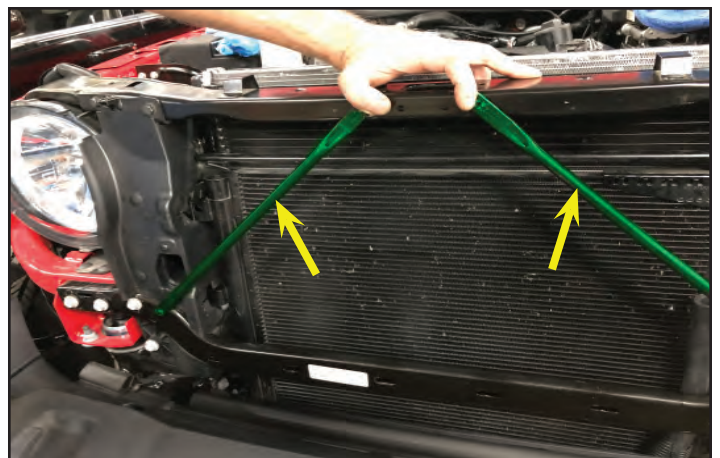

65. Remove both side front closeout panels highlighted in green. Remove the LH and RH close out panels by removing the fir tree connectors securing them to the radiator cradle.

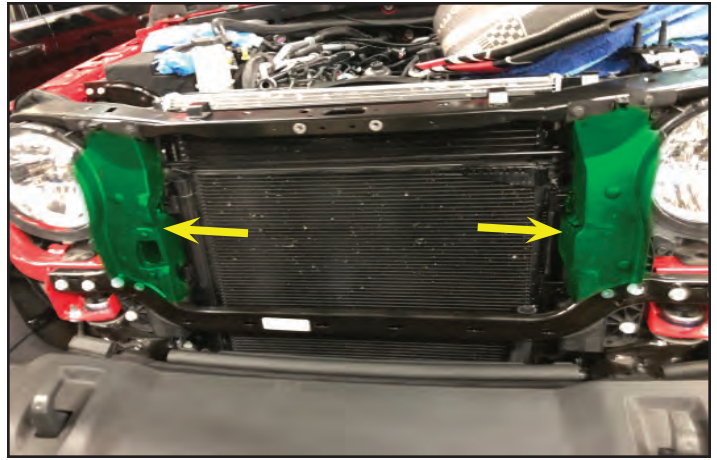

66. Remove horns and brackets, and electrical connections from the vehicle at yellow arrow locations. The location for the horn bracket removal is shown in the next photo. The removal of the ambient air temp (AAT) sensor (green arrow) will be shown later.

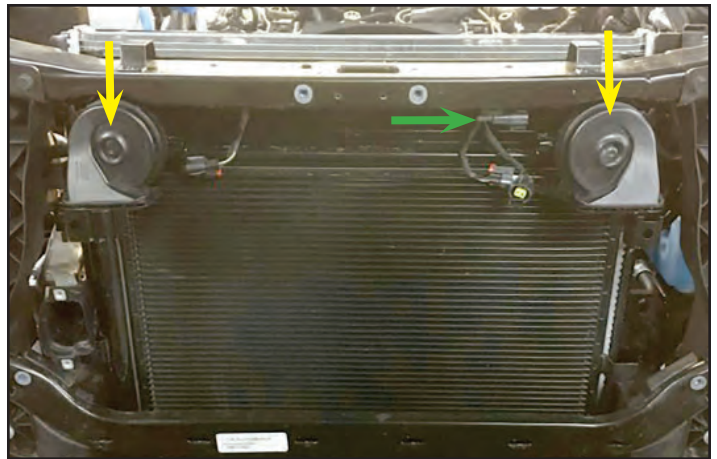

67. Remove the bolt shown near the radiator on the cross frame to remove the horn bracket. Repeat this process on the other side of the vehicle.

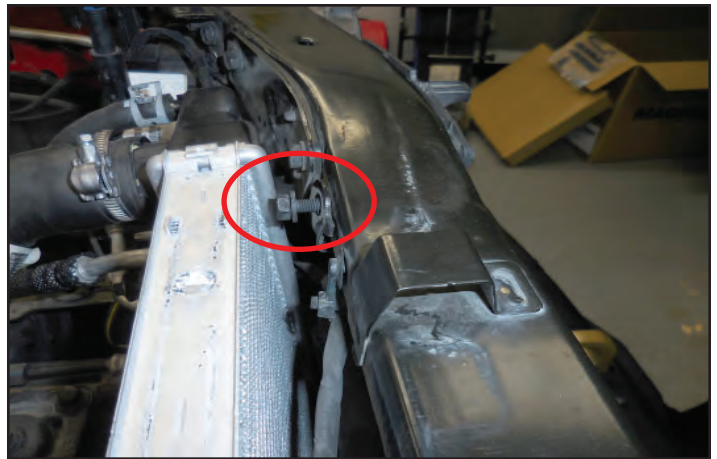

68. Remove ambient air temp (AAT) sensor as well by prying the connector shown at the yellow arrow.



69. Route intercooler hose: 392 Jeep Hose **31-26-64-023A** (highlighted in green) around the back of the engine and over toward the driver's side as shown.



70. Route the other end of the -023A hose from the last step through the opening created by removal of the tab in a previous step. Gently push the hose (highlighted in green) from inside the engine compartment. You may need to push the hose further through to help make the clamp connection at a later step.

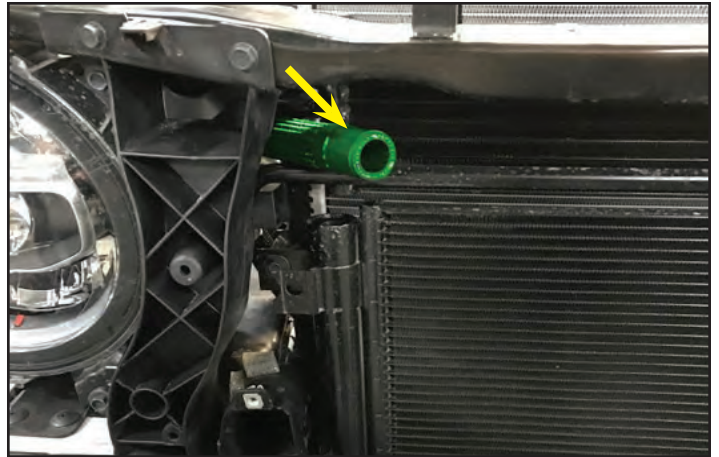

71. Three 10mm bolts secure the drivers' side headlight to the vehicle. Remove the bolts and carefully pull the headlight out.



72. Disconnect the wiring harness at the back of the headlight then set the headlight aside.



73. Gather the horn relocate brackets PN 65-26-61-045. Install (4) U-nuts PN 77-01-06-003 in the orientation and locations shown.



74. Install the horn relocation brackets around the factory cross-brace in the locations shown. **Ensure they do not block the slotted holes for the front fascia.**



75. Select (2) M6 X 35mm long fasteners from the kit. Install the fasteners in the locations shown and tighten until the brackets just start to interfere with the cross member. Do not overtighten the fasteners as they will interfere with the AC condenser.



76. Select (2) ½" P-clips and (2) M6 X 16mm fasteners from the kit. Install the P-clips over the power steering cooler line in the orientation shown. Install the M6 fasteners through the P-clip into the U-nut and tighten securely.



77. Remove the nut securing the factory horn brackets to the back of the horns. Discard the factory horn brackets.



78. Install the horns onto the bottom of the horn relocation brackets in the orientation shown. Secure the horns using the factory nuts removed in the previous step.



79. The horn wiring harness (highlighted in green) is secured to the upper radiator cradle by two fir tree connectors. Carefully remove both from the harness in the locations shown.



80. Re-route the horn harness down along the LH side of the radiator.(highlighted in green).

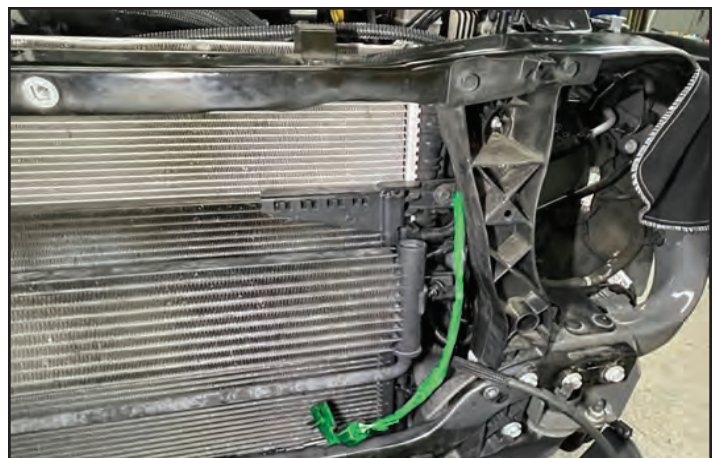

81. Install the longer factory horn wiring harness takeout to the LH horn.

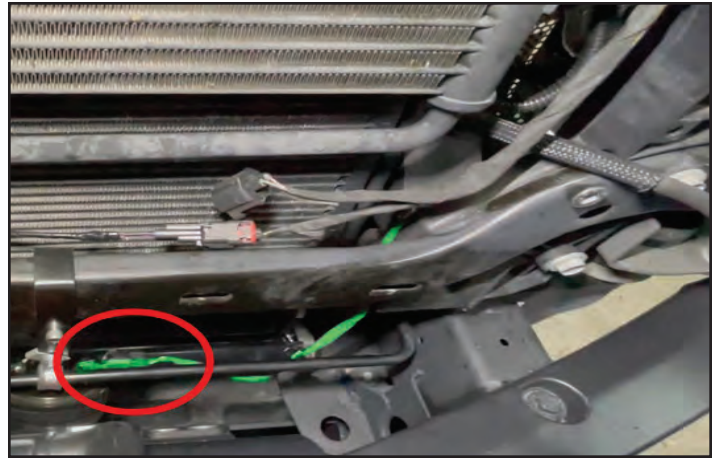

82. Install the horn extension harness PN 82-55-80-122 (highlighted in green) to the shorter factory horn harness takeout, then route the extension to the passenger side horn. Connect the harness to the horn.



83. Use zip ties to secure the horn harnesses to the radiator cradle and cross brace as required.

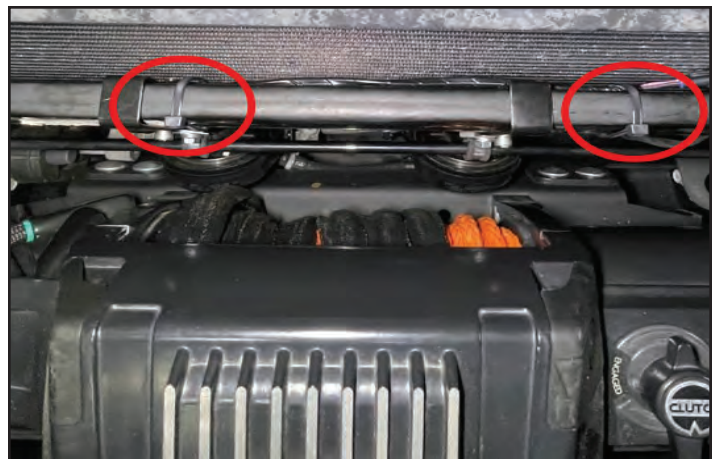

Section 5: Intercooler Pump Install

84. Remove the black fastener used to secure the A/C lines at the LH side of the radiator.



85. Drill a ¼" diameter hole through the LH plastic radiator cradle support at the location shown.



86. Select the intercooler pump mounting bracket PN 65-26-61-037. Install an M6 panel nut PN 77-01-06-003 into the circled location shown.



87. Install the intercooler bracket in the orientation shown. Re-install the factory screw through the bracket into the A/C block and run it down until it just contacts the bracket.



88. Select (1) M6 X 16mm long bolt PN 71-06-10-035 from the kit. Install it through the front of the radiator cradle support and into the U-nut in the bracket.

Now tighten both fasteners to secure the bracket in place.



**M6 x 16mm Long
Fastener installs here**

89. Select the intercooler pump. If it has the following rubber grommet (arrow location) installed as received, it must be cut off and removed from the pump body. A revised rubber grommet will need to be installed as shown in the next step.

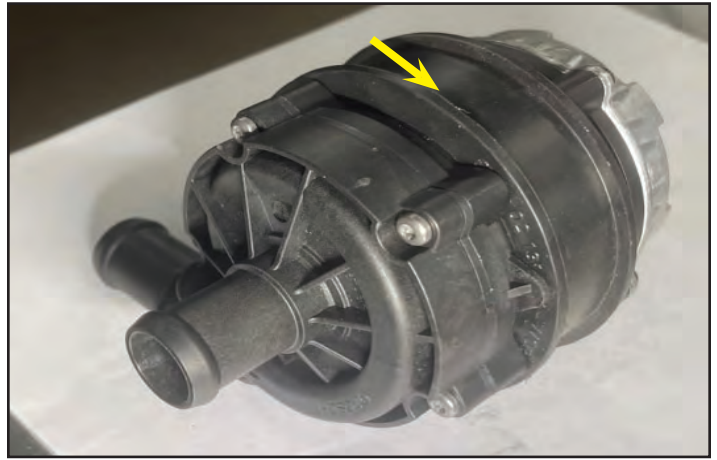

90. Apply a small amount of lubricant from the kit to the grommet (PN 68-01-00-042) and pump body. Install the grommet over the pump with the M-shaped slot facing TOWARD the aluminum end plate on the pump. The slot should orient so it is opposite the electrical connector as shown. This will ensure the pump inlet and outlet ports face in the correct locations to allow the intercooler hoses to connect to the pump. The edge of the M-shape will line up with the edge of bolt boss (arrow location).

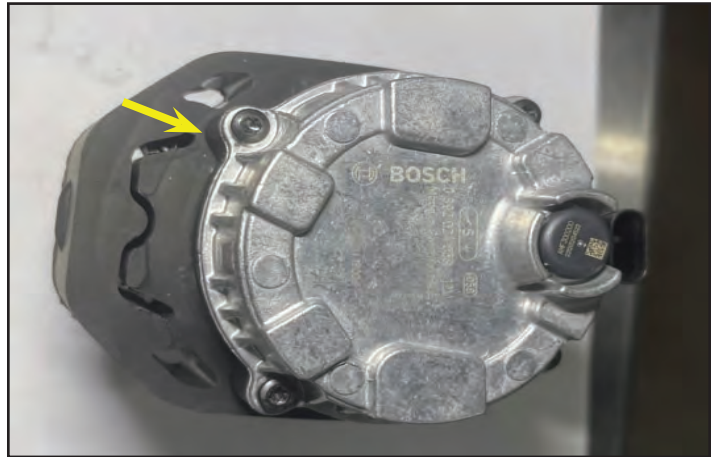

91. Install the pump onto the bracket in the orientation shown, ensuring the rubber grommet is fully seated.

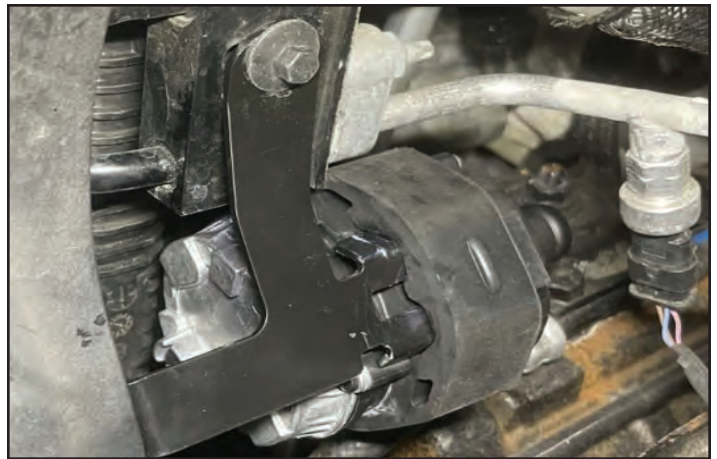

92. Select the low temp radiator (LTR) PN 68-01-00-166 from the kit.

Apply a one inch-piece of self-adhesive foam tape to the bottom of each locator (LH side shown, RH side similar).

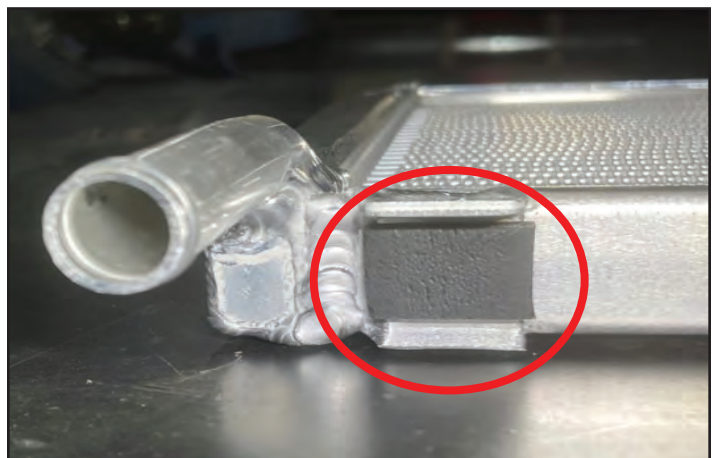

93. Apply a 6 inch long piece of foam tape (highlighted in green) to the back of each tank on the LTR, starting 3 inches from the top.

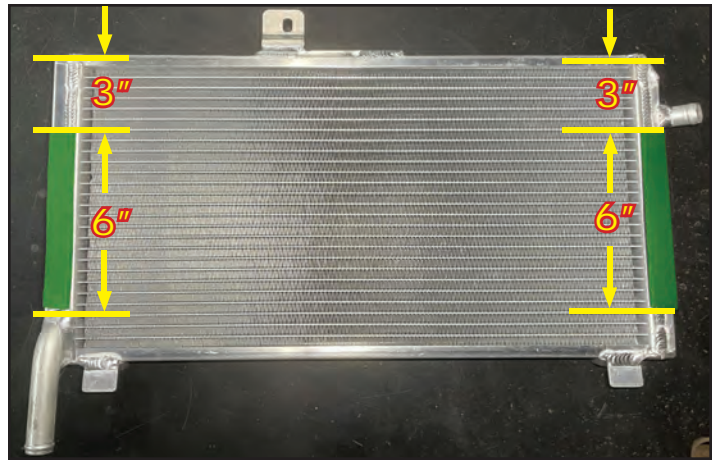

94. Measure up 1 inch from the end of the bottom tube on the LTR. Mark the tube at this location using a sharpie marker.

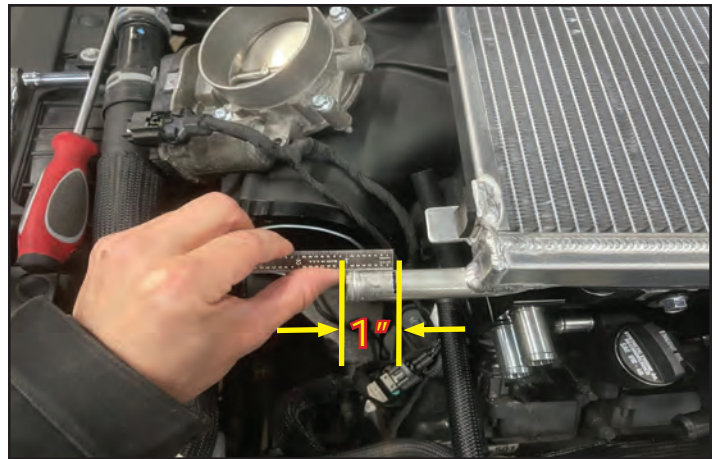

95. Select the 023D (U-shaped hose) and a Powergrip heat shrink clamp from the kit.

Install the Powergrip clamp from the kit to the SHORT end of the 023D hose then install and orient the hose onto the lower LTR tube up to the line that was made previously.

Using a heat gun, heat up the Powergrip clamp to secure the hose to the LTR at the arrow location.



96. Prepare to install the LTR sub-assembly into the vehicle.

Route the 023D hose (highlighted in green) down between the core support and factory radiator, then around and up toward the intercooler pump in the left front corner of the engine bay.

Position the LTR so that the bottom mounting tabs rest on the top of the core support.



97. Here is a closeup photo of the 023D hose (highlighted in green) being routed between the core support and factory radiator.



98. Install a 4-inch piece of supplied convolute tubing (highlighted in green) with the slot facing down, onto the 023D hose at the location shown. This will protect the hose from abrasion against the bottom of the radiator.

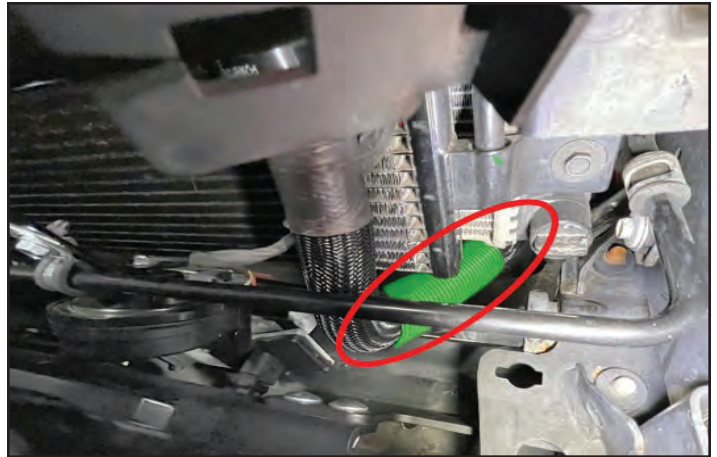

99. Working from the left front corner of the engine bay where the intercooler pump is mounted, route the 023D coolant line upward toward the pump.

Select a $\frac{3}{4}$ " constant tension clamp from the kit and pre-install it over the end of the 023D hose.

Install the hose onto the intercooler pump as shown. Secure it with the clamp.



100. Install the 023A coolant hose onto the upper port of the LTR. Secure it using a $\frac{3}{4}$ " constant tension clamp from the kit. (Blue encircled area).

Position the LTR so that the hole in the upper bracket is centered over the factory installed nut at the arrow location shown. Harvest a bolt from the takeoff pencil braces and fasten the LTR into position using the bolt. (Red arrow).



Section 6: PCV Oil Separator Install

101. Remove the nut located in the center of the firewall at the location shown.



102. Select bracket PN 65-26-61-047 and (2) self-tapping screws PN 74-74-08-038 from the kit. Install the bracket to the oil separator as shown.



103. Install the oil separator sub-assembly over the stud on the fire wall then secure it using the factory nut.

The hoses will be plumbed and routed after the supercharger is installed.



Section 7: Intercooler Pump Relay Wiring

104. Remove the ground nut at the location shown.

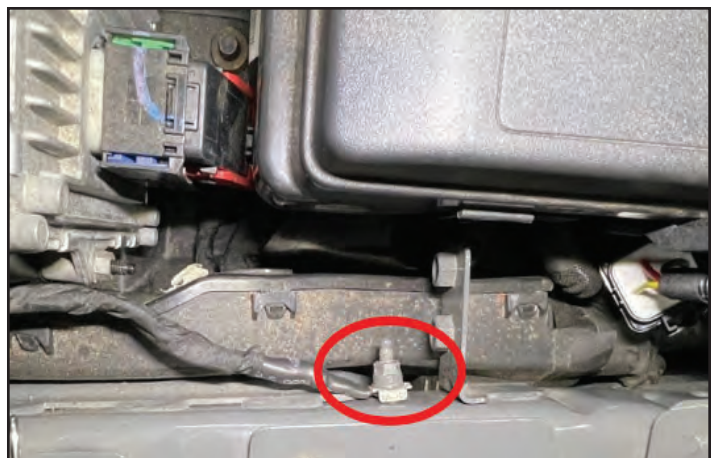

105. Install the BLACK ground wire with the ring terminal attached (highlighted in green) onto the factory ground location then re-install the nut and tighten it securely.

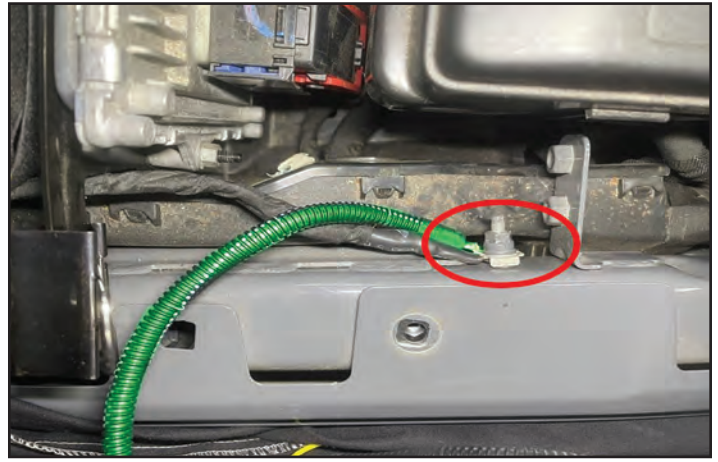

106. Fasten the relay and fuse holder in the orientation shown to the body bolt at the arrow location.

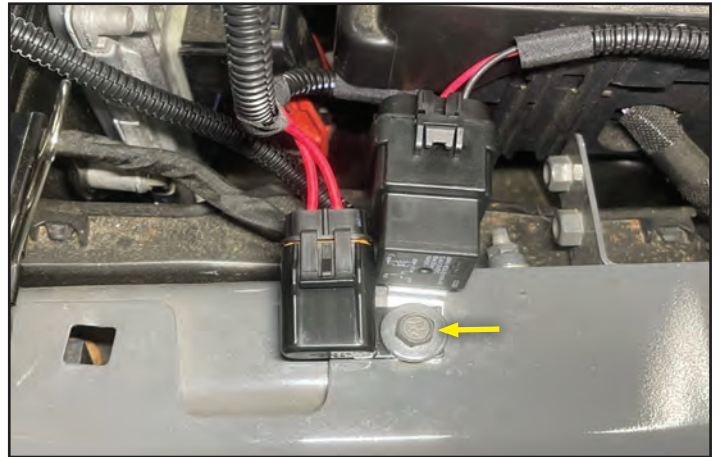

107. Install the blue 15 amp fuse into the fuse holder then secure it back into the cover.



108. Remove the factory-installed nut at location N2 in the fuse box. Fasten the RED wire with the ring terminal attached (highlighted in green) to the positive terminal and re-secure it using the factory nut.



109. Using a small round file or die grinder, carefully grind a small recess in the fuse box to allow the yellow intercooler pump trigger wire to pass through.

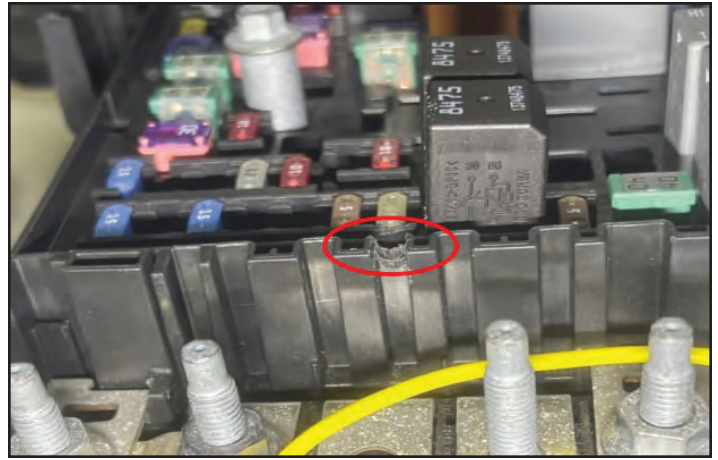

110. Pass the yellow trigger wire through the recess and route it into the fuse box.

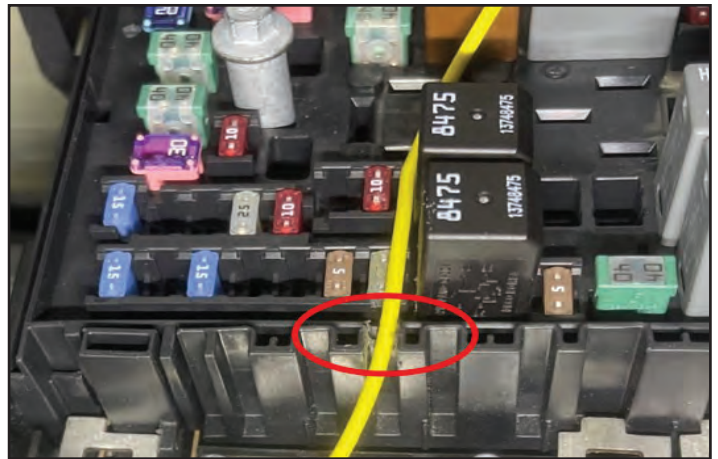

111. Remove the 25A fuse at location F04 (green arrow).

The end of the yellow wire has a fuse tap pre-installed.

Slip the fuse tap onto one side of the 25A fuse (shown below) then re-install the fuse back into the fuse box in location F04 again.

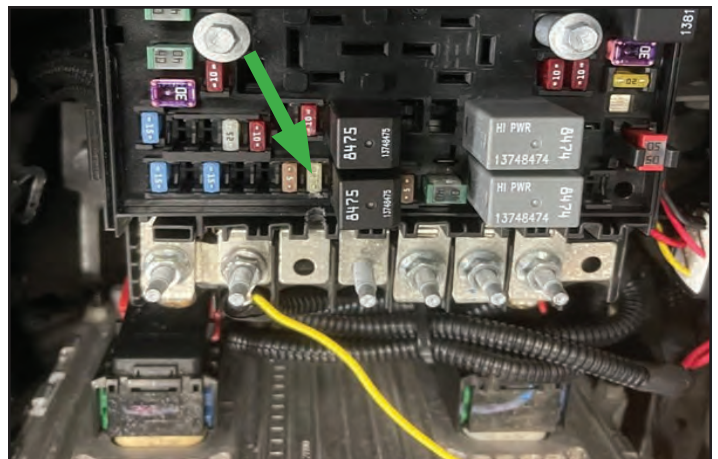

112. Route the yellow wire within the fuse panel so it does not protrude through the cover.



113. Loop the extra wire neatly in behind the fuse box. Use a zip tie to secure the bundle together then tuck it behind the box.

Re-install the fuse box cover.

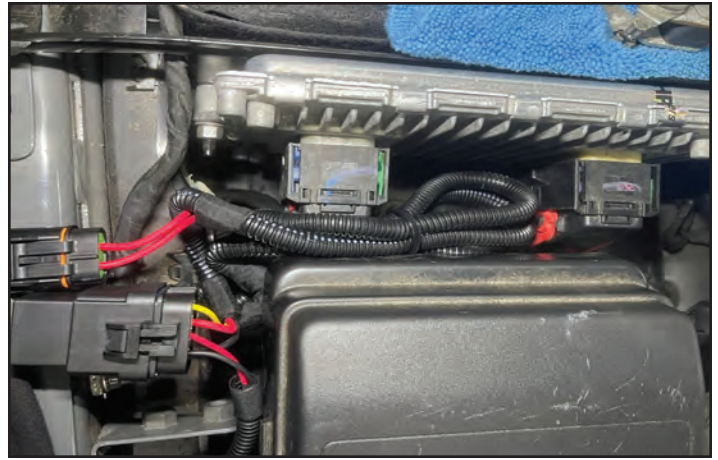

114. Route the opposite end of the wiring harness containing the intercooler pump hardshell connector (highlighted in green) around the back of the passenger side headlight, across the front of the radiator cradle and over toward the intercooler pump. Use zip ties as needed to secure it in place (arrow locations).



115. Continue routing the wiring harness (highlighted in green) over toward the intercooler pump (yellow arrow). Use zip ties as needed to secure it in place along the route as needed.

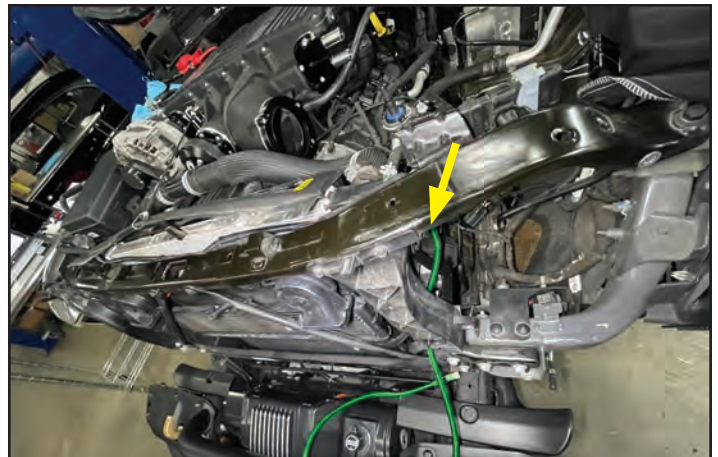

116. Plug the intercooler pump hardshell connector into the pump (red arrow).



117. Loop any extra length of wire neatly and zip tie it to the pump bracket.

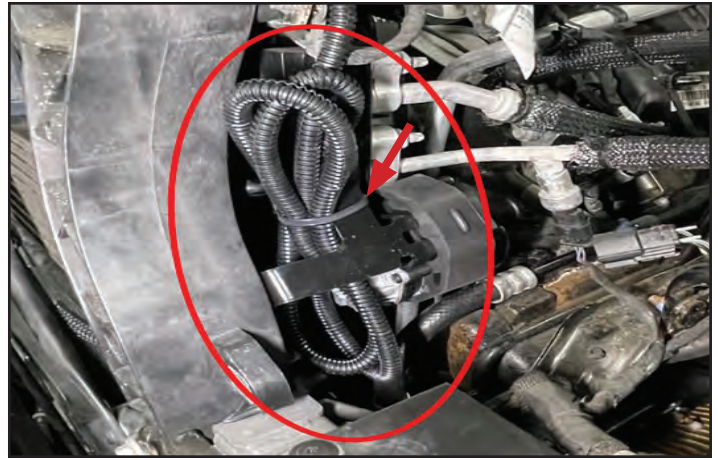

Section 8: Coolant Reservoir Relocation

118. Remove the 2 nuts securing the factory coolant reservoir to the fire wall. Save this hardware, it will be re-used later.

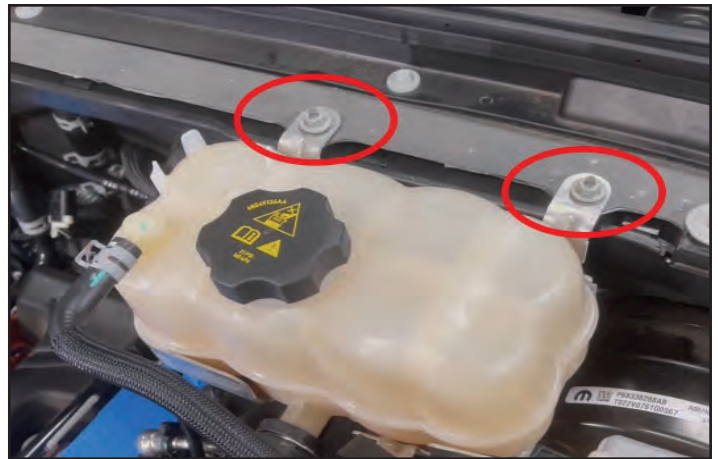

119. Remove (2) fir tree connectors securing the hoses to the bracket.



120. Here are the two fir tree connectors after removal.

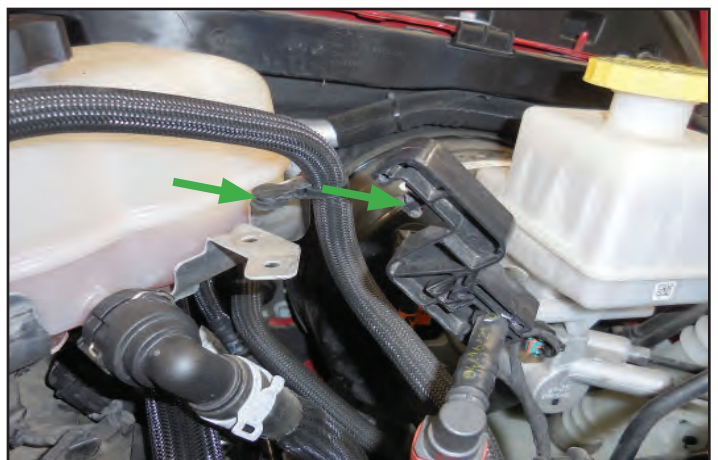

121. Lift the coolant reservoir up and out of the way of the factory studs then remove the fastener that secures the reservoir bracket to the reservoir in the location shown.

Separate the reservoir and bracket. Set the reservoir off to the side for now.

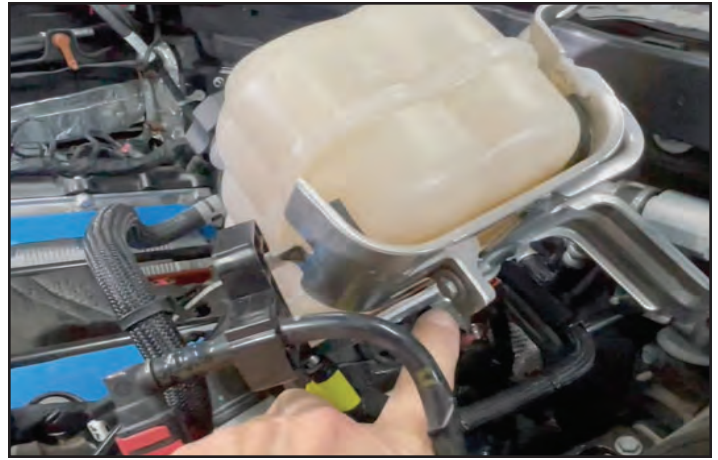

122. Remove the tensioner from the front of the engine using a 16mm socket.

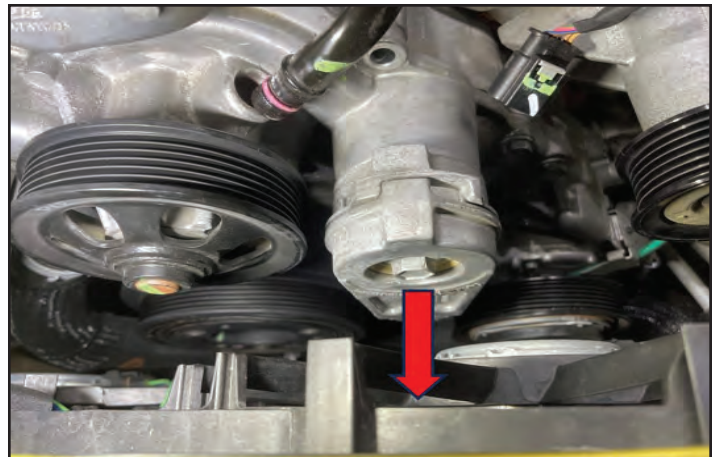

123. Use a thin-wall 13mm socket to remove the 2 fasteners in the locations shown on either side of the heater tube.

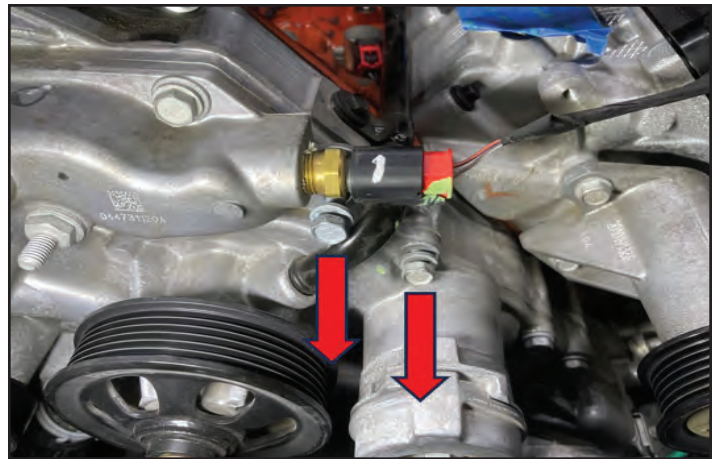

124. Select the following parts: Bracket (PN 65-26-61-025), M8X1.25X110mm long fastener (PN 71-08-12-110), and M8X1.25X40mm long fastener (PN 71-08-12-040). **Apply Loctite 242 to the threads** on each bolt and install them in the bracket as shown.

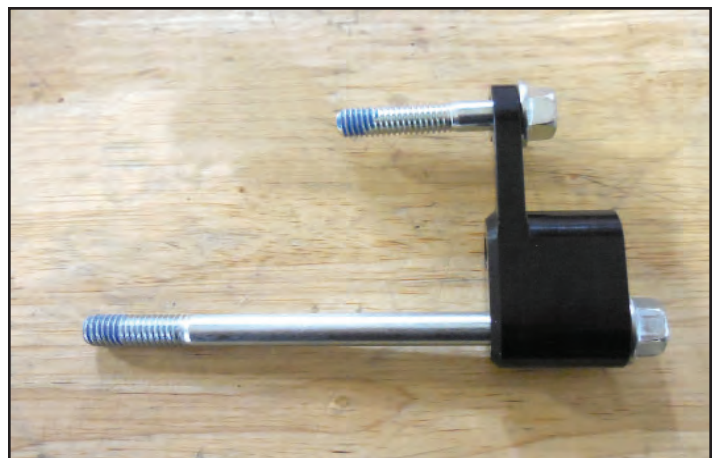

125. Install the bracket assembly into the location shown on the water pump housing with a 12mm socket wrench. **Torque the fasteners to 18 ft-lbs.**

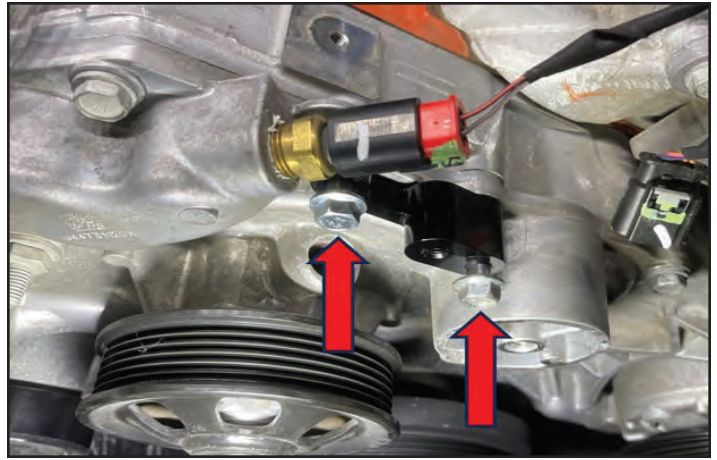

126. **Apply Loctite 242 to the OEM fastener** and re-install the factory tensioner using a 16mm socket. **Torque the tensioner to 33 ft-lbs.**

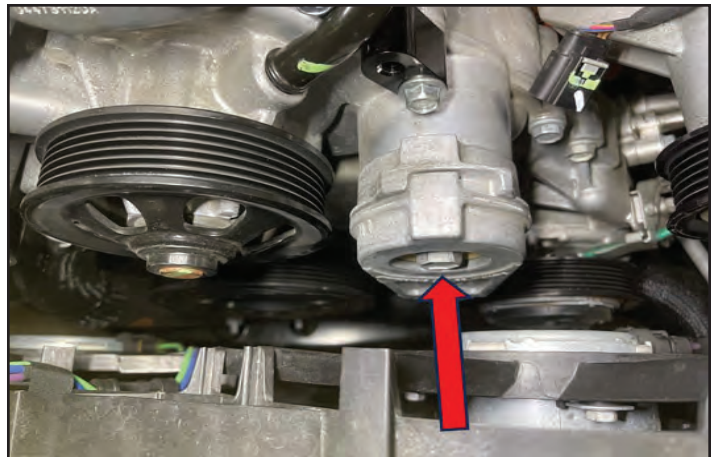

Section 9: FEAD Bracket Sub-Assembly

127. The FEAD bracket is assembled per the diagram shown. A full-size version is also available in Appendix 3 at the back of the manual.

The following steps will detail the assembly and installation sequence.

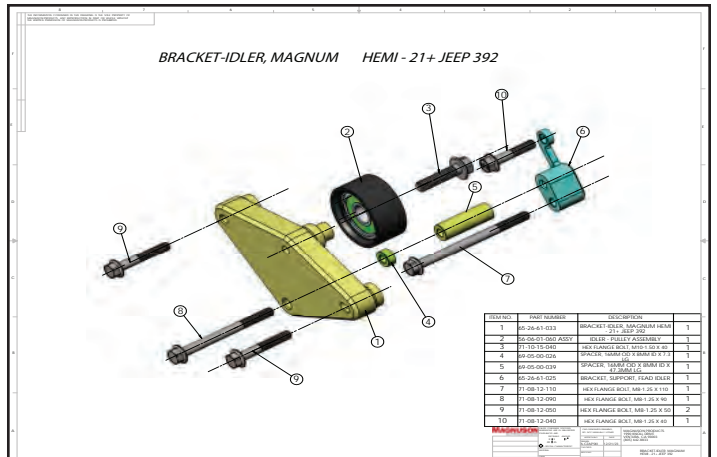

128. Select the parts shown in the photo.



129. **Apply Loctite 242 to all bolts prior to installation.** Sub-assemble the idler and the two M8x50mm long bolts (yellow arrows) and the M10x40mm long bolt (green arrow). **Torque the M10 bolt to 40 ft-lbs.** to secure the idler pulley to the bracket.

The M8 X 90mm long bolt and (2) spacers (highlighted in red) are shown installed to the bracket for assembly clarity, however these should NOT be installed until after the bracket has been installed onto the engine, to allow for serpentine belt routing.

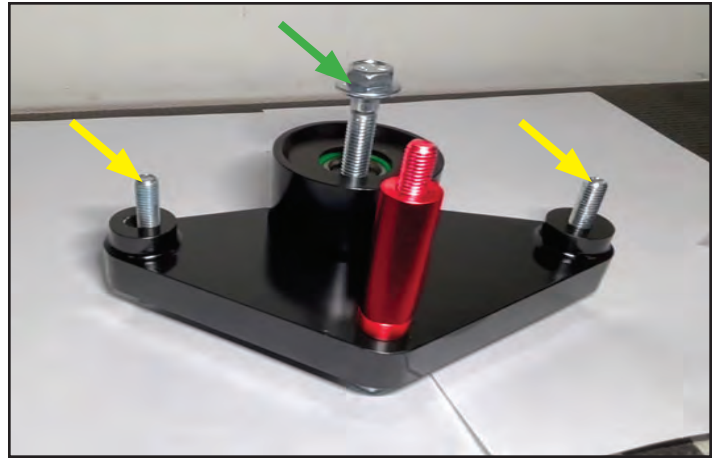

130. Moving over to the vehicle, remove the (2) fasteners in the location shown. Leave the factory idler pulleys in place.



131. Pre-install the idler bracket sub-assembly onto the front of the engine in the location shown. Hand-start the 2 fasteners through the factory pulleys a few turns but do not tighten them.



132. Pre-install the new belt PN: 79-06-09-080 (Gates K060980) around the pulleys and through the idler bracket as shown in the photo.

Tip: Use a bungee cord or long zip tie to temporarily hold the belt over to the RH side of the vehicle. This will keep it in place on the pulleys until remaining FEAD components have been installed.

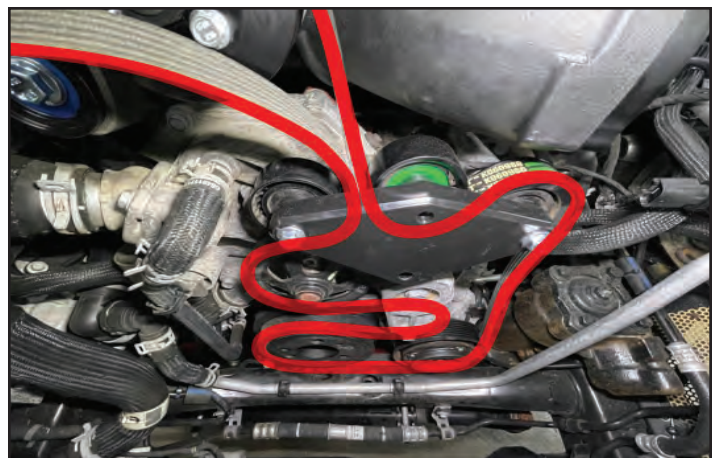

133. Once the belt has been routed correctly through the idler bracket, you can now install the lower bolt PN 71-08-12-090 and the (2) spacers (1 short PN 69-05-00-026 and 1 long PN 69-05-00-039) that were highlighted in red back in the idler bracket sub-assembly step. Tip: use tape around the 2 spacers to hold them together while you slip them in place behind the bracket and install the lower bolt.

Zero torque all (3) bracket fasteners, ensuring the bracket sits flush at all its' mounting points. Torque all (3) M8 bracket bolts to 20 ft-lbs.

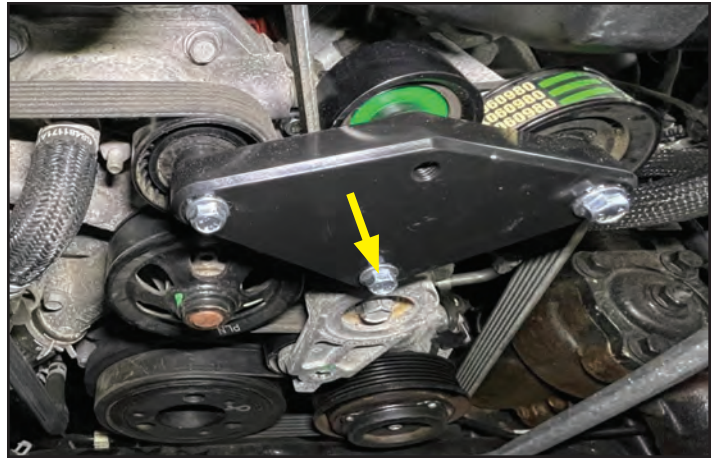

134. The supercharger must be partially disassembled prior to installation in the vehicle. Remove all the fasteners securing the upper lid to the base.



135. Remove (6) internal fasteners securing the CAC's to the base.

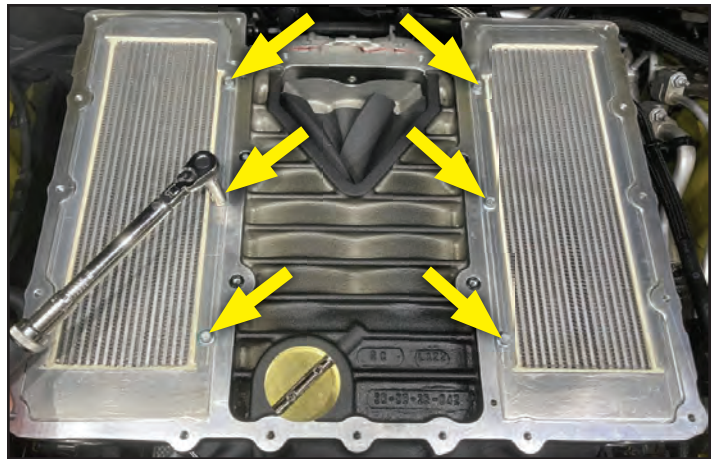

136. Remove (6) turret fasteners from the front securing the turrets to the base. Three fastener locations are shown here. (RH side shown, LH side similar)

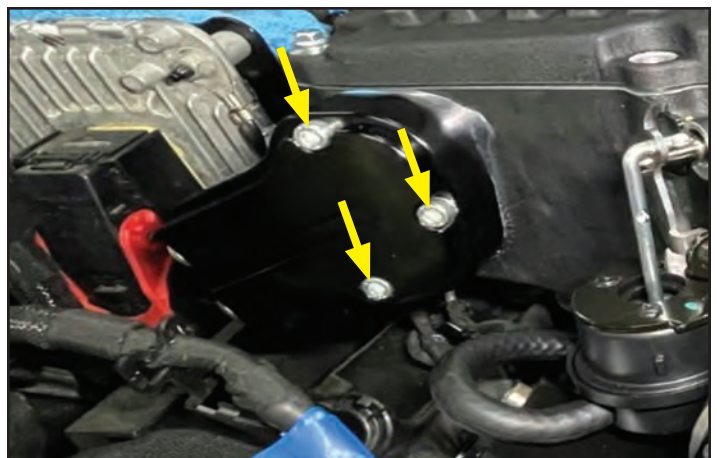

137. Carefully remove the LH and RH CAC's out of the intake and set them aside.

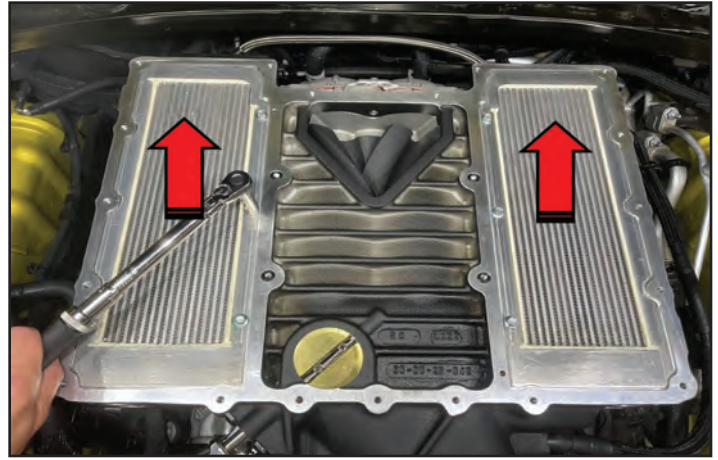

Section 10: Supercharger Preparation

138. Gather the provided MAP sensor PN 82-55-57-00 and (2) M5 X 0.8 X 20mm long bolts PN 72-05-08-020. Apply **Loctite 242 to the two M5 bolts.**

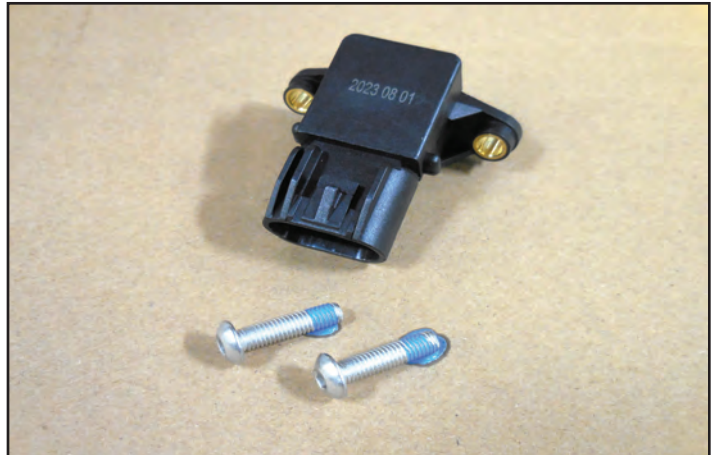

139. Install the map sensor to the LH side rear of the supercharger with the M5x20mm bolts as shown. **Torque to 70 in-lbs.**

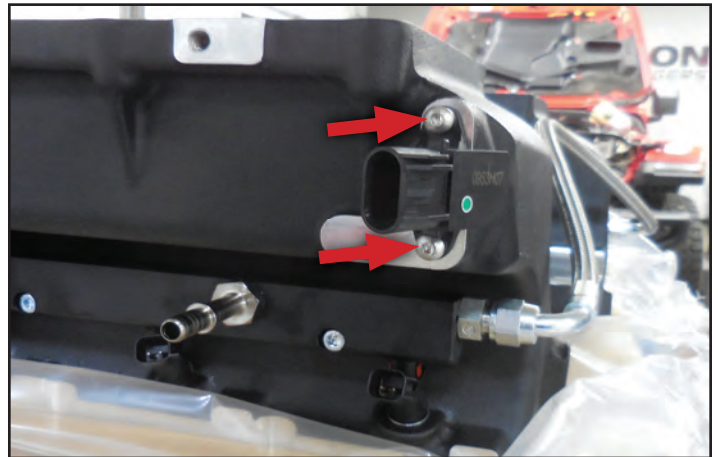

140. Orient and install (2) supercharger to intake gaskets, ensuring the ports for the PCV and oil fill align with the holes in the casting. Secure the gaskets to the supercharger using (4) nylon push pins PN 69-99-05-004 at the 4 green circles.



141. If you are installing a boost gauge, there is a spare 1/8" NPT plug on the RH rear corner of the supercharger for this provision.

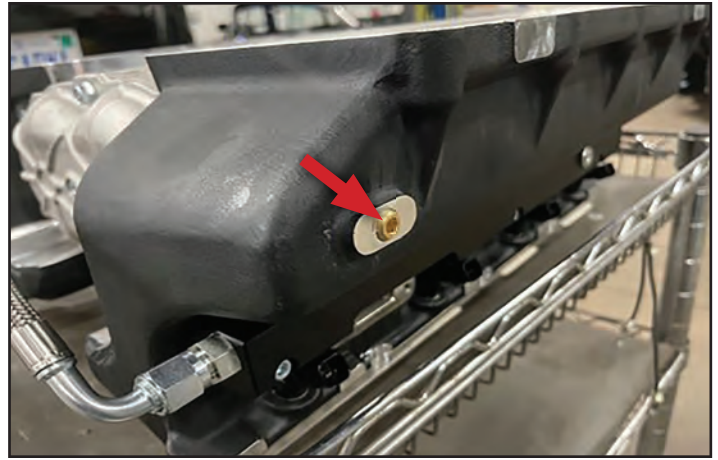

142. Remove the stock throttle body from the factory intake. Harvest the factory throttle body gasket from the intake and install it onto the inlet adaptor on the supercharger.

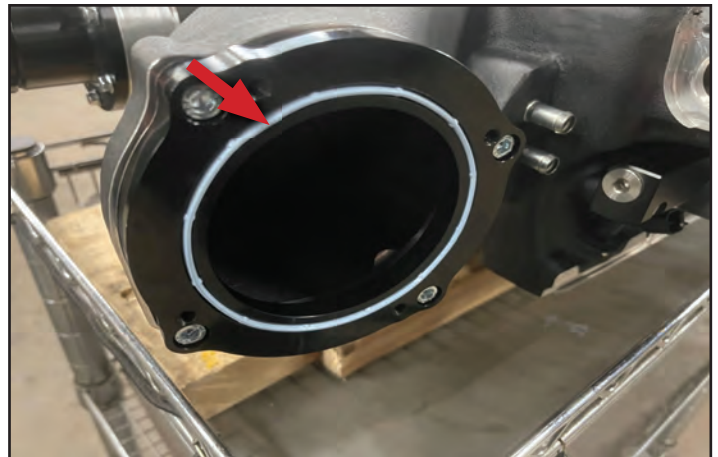

143. Prior to installing the supercharger, install the IAT sensor extension harness (PN 82-55-53-009)(highlighted in green) to the sensor located at the RH front corner of the supercharger (red circle location). Route it under the inlet and over to the LH side. Stow it so it will not get in the way of the mounting flange surface as the supercharger is installed to the engine.



144. Select the 023G PCV hose from the kit (highlighted in green). Install the 90-degree end to the PCV fitting located at the RH rear corner of the supercharger. Route it over the top of the housing temporarily.



145. Install the ½” bulk hose (highlighted in green) to the tube fitting at the RH front corner of the supercharger (under the bypass valve). Route it over the top of the supercharger temporarily.



146. Flip the supercharger over and route the 1/2” bulk hose from the last step as shown (highlighted in green). This will keep the hose out of the way during installation.



147. Remove any material covering the intake ports. Ensure they are wiped clean and no foreign material has entered the engine.



148. Ensure that all items are clear from around the intake ports prior to installing the supercharger.



149. With the aid of a helper, install the supercharger onto the engine.



150. Gather the (10) provided M6X1.0X40mm long fasteners and apply **Loctite 242 to the threads as shown.**



151. Install the (10) M6x1.0x40mm fasteners from the last step into the supercharger mounting locations. Hand-start and zero-torque all fasteners following the torque sequence at the back of this manual. **Pre-torque all 10 fasteners to 53 in-lbs in sequence. Final torque all 10 fasteners to 106 in-lbs in sequence.** Once you have torqued these fasteners you should spin the supercharger pulley by hand to ensure that the rotors are spinning freely.



152. Re-install the charge air coolers into the supercharger ensuring the coolant ports line up with the holes in the front of the housing. **Apply blue Loctite 242 to (6) inboard CAC fasteners** and re-install them. **Torque them to 84 in-lbs.** Ensure the (4) black O-rings are in place as shown in the photo.

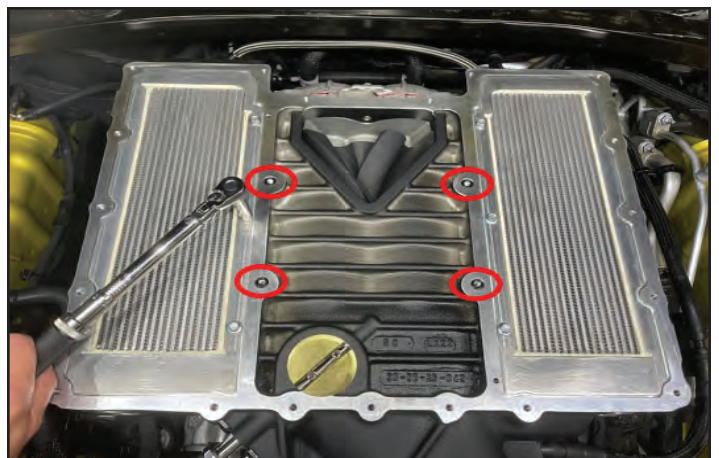

153. Re-install the supercharger lid onto the housing. Re-install all the lid fasteners. Make sure to remove the Magnuson badges to allow access to the four center bolt (M6x30mm) locations circled in red here. These M6x30mm bolts are located in a supplied bag. Follow the sequence for the lid bolts shown at the back of this manual. **Final torque the lid fasteners to 106 in-lbs.**

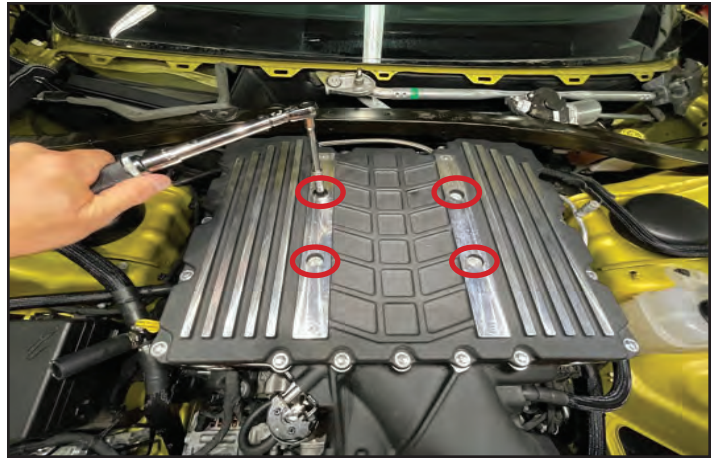

154. Select the charge air cooler turrets. Apply Lubriplate to the O-rings as shown below then re-install them to the appropriate sides of the supercharger. **Apply Loctite 242 to the original turret fasteners, run them down then final torque them to 106 in-lbs.**



155. Re-connect the wiring harness take-outs for all 8 fuel injectors. Ensure the locks are engaged on all 8 connectors. RH shown, LH side is similar.



156. Select the coolant reservoir relocation bracket PN 65-26-61-041 from the kit.

Install the bracket in the location and orientation shown.



157. Select (2) M6 nuts from the kit and install them onto the factory studs to secure the relocation bracket to the vehicle. **Torque to 106 in-lbs.**

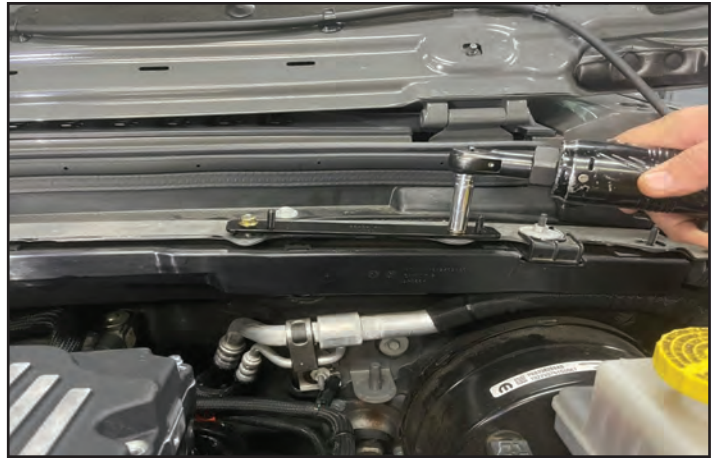

158. Temporarily install the reservoir bracket over the studs on the relocation bracket. Note that the reservoir bracket mounting tabs need to be notched to provide clearance to nuts that secure the relocation bracket to the vehicle.

Use a sharpie marker to identify the amount of material that needs to be removed. This operation will be completed in a subsequent step.



159. While the reservoir bracket is temporarily installed, check the clearance adjacent to the side of the supercharger in the location shown. Due to variation in body to engine position on each vehicle, the coolant reservoir bracket may need to have a window cut in it as detailed in the following slides if there is insufficient clearance. If you cannot put a finger between the reservoir bracket and the side of the supercharger housing, it is recommended to notch the bracket as detailed in the following steps.



Section 11: Coolant Reservoir Bracket Modification

160. If the clearance between the coolant reservoir bracket and the side of the supercharger is not sufficient you will need to cut a 3 inch wide X 1 inch tall window in the reservoir bracket as shown here.

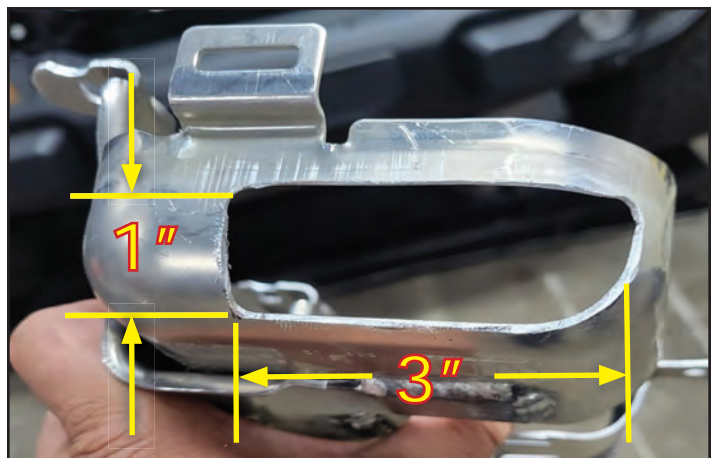

161. Bend the lower mounting tab on the reservoir bracket to the right approximately 1 inch so that it installs properly over the (2) upper studs and (1) lower stud as it is lowered into place.

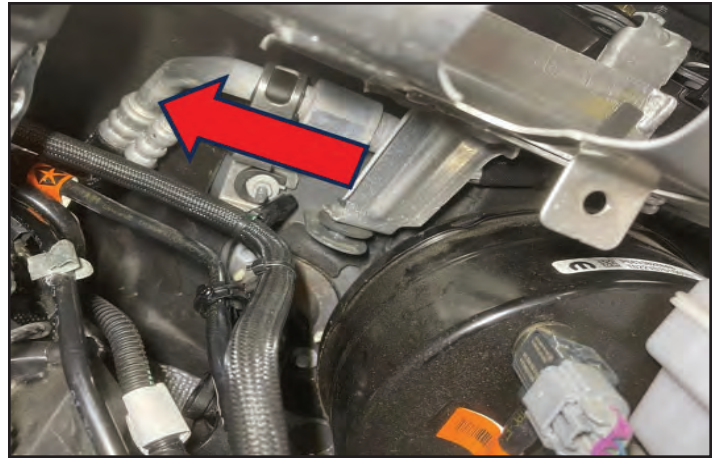

162. Using a die grinder, notch the bracket mounting tabs as identified in the previous slides while the bracket was trial fit.

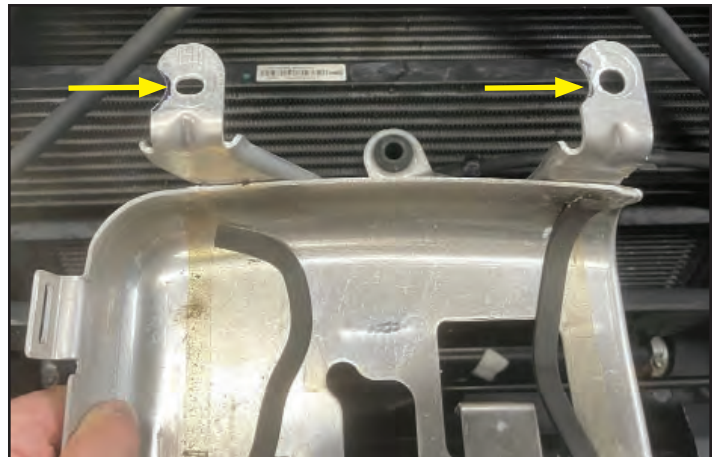

163. You can now install the modified reservoir bracket permanently onto the studs of the relocation bracket and over the locating pin at the base.

Secure the reservoir bracket using the (2) factory nuts that originally secured it to the vehicle. **Tighten to 106 in-lbs.**

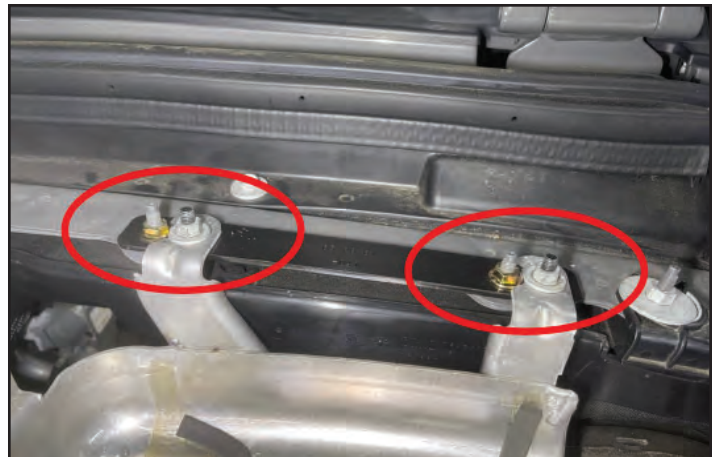

164. Re-install the factory reservoir into the bracket ensuring the locating tab on the RH side engages into the slot in the bracket. Secure the reservoir into the bracket using the factory bolt. **Tighten to 106 in-lbs.**



165. Re-install the (2) fir tree connectors that secure the coolant line and brake booster hose to the reservoir bracket.



166. Remove the fastener securing the power steering reservoir to the factory bracket in the location shown.



167. Install an M6 panel nut from the kit PN 77-01-06-003 to one end of the power steering relocation bracket. Install the power steering reservoir relocation bracket to the vehicle using the factory bolt back in its' factory location. Use an M6 X 20mm long bolt PN 71-06-10-020 from the kit to secure the reservoir to the relocation bracket. Install the bolt through the reservoir and thread it into the panel nut. Tighten both bolts to secure the reservoir and bracket.



168. The factory alternator bracket mounting flange has (2) hollow dowels installed. Use vice grips to clamp them and carefully twist them out of the bracket, ensuring you do not make them oval.



169. Select the alternator spacer bracket PN 65-26-61-035. Install the (2) hollow dowels into the spacer in the locations shown. Note: Your bracket may be silver.

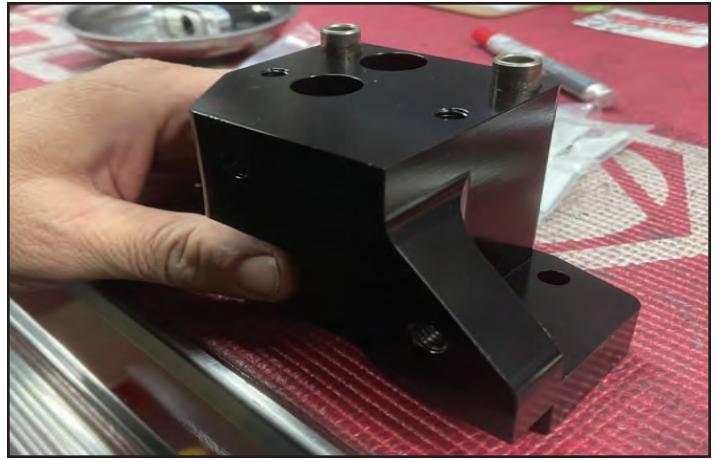

170. Install the alternator spacer bracket onto the top of the engine in the location and orientation shown.



171. **Apply Loctite 242 to the (4) supplied M8 X 35mm long bolts** from the kit PN 71-08-12-035 as shown below. Secure the spacer from the last step in the locations shown with these bolts. **Torque bolts to 20 ft-lbs.**

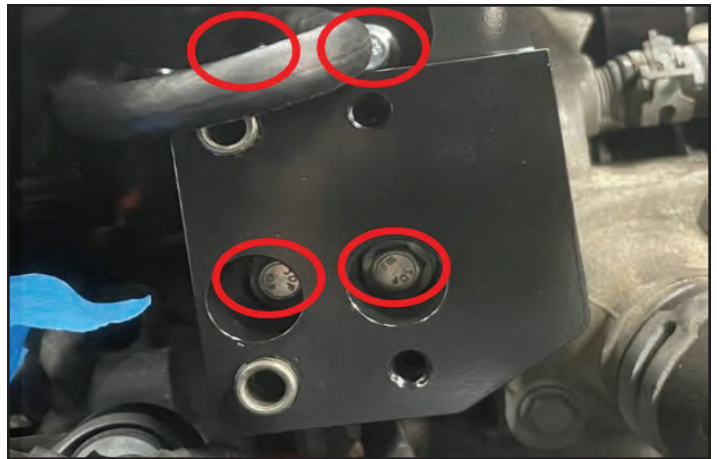

172. Select the factory alternator mounting bracket. Radius the corner shown in the photo to provide additional clearance to the bypass actuator.

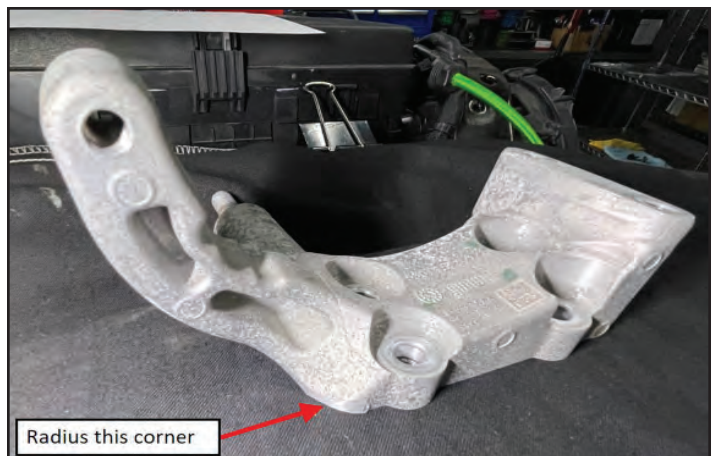

173. Install the alternator mounting bracket to the spacer, ensuring the dowels seat into the counterbored holes. Install the factory bolts.

Torque the bolts to 20 ft-lbs. in a criss-cross pattern. Ensure the bracket has fully seated against the spacer.

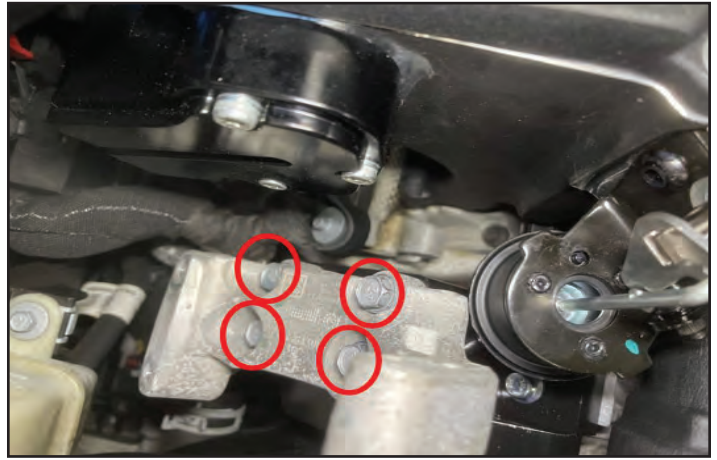

174. Select the following parts:

- Grooved idler PN 56-50-47-009 (Dayco 89085)
- Spacer PN 69-90-57-025
- M10 X 80mm long bolt PN 71-10-15-080.

Apply Loctite 242 to the M10 X 80mm long bolt then install through the bearing and spacer.



175. Install the grooved idler sub-assembly into the passenger side threaded hole in the alternator spacer bracket. **Torque the bolt to 40 ft-lbs.**

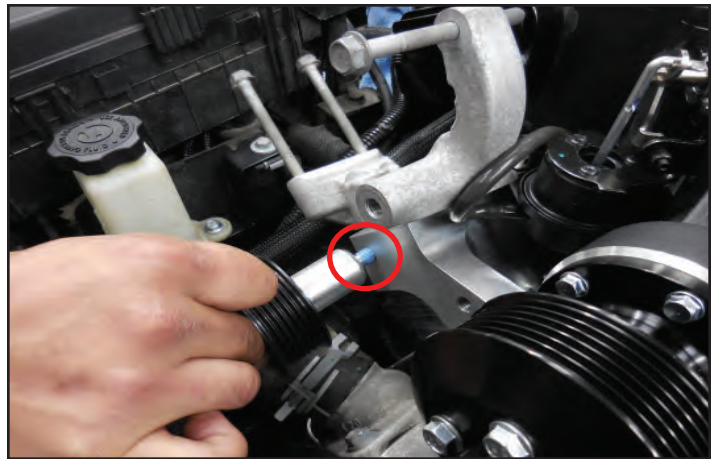

176. Select the following parts:

- Smooth idler PN 56-06-01-054-BL
- Spacer PN 69-90-57-025
- Bolt PN 71-10-15-080.

Apply Loctite 242 to the M10 X 80mm long bolt through the bearing and spacer as shown.



177. Install the smooth idler sub-assembly into the inboard position of the alternator spacer.

Torque the M10 bolt to 40 ft.-lbs.



178. Re-install the alternator to the factory bracket using the factory bolts.

Torque the bolts to 20 ft.-lbs.

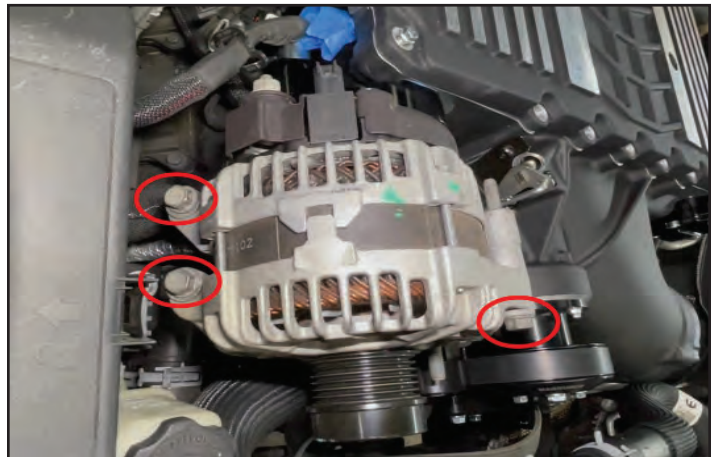

179. Re-connect the B+ terminal to the back of the alternator. Re-install the factory nut and tighten securely.

Select the 5-inch alternator extension harness PN 82-55-80-121 from the kit. Install it between the factory 2-pin harness connector.

Connect the opposite end to the back of the alternator. Ensure both connectors are fully seated.



180. Re-install the B+ cover onto the terminal



181. Route the serpentine belt around the pulleys as per the belt routing diagram in Appendix 1 at the back of this manual. The smooth idler pulley with the yellow arrow shown here should be the last pulley that you place the belt over once you are done routing the belt over all the other pulleys.

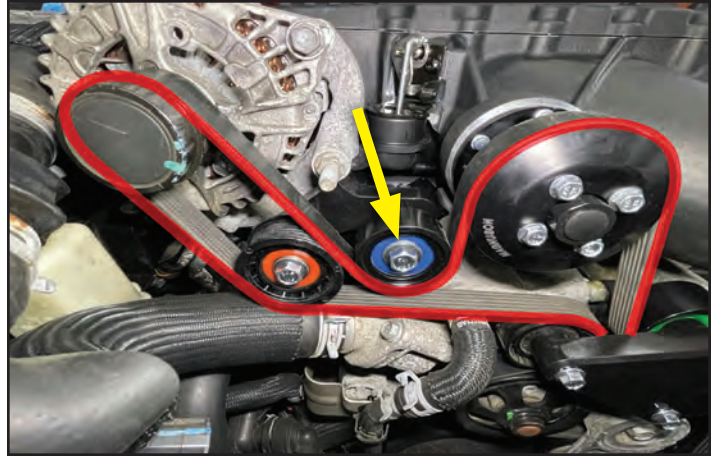

182. Using a long breaker bar, cycle the tensioner and install the belt over the upper smooth idler shown in the last photo with the arrow.

Verify the belt is properly seated around all the pulleys.

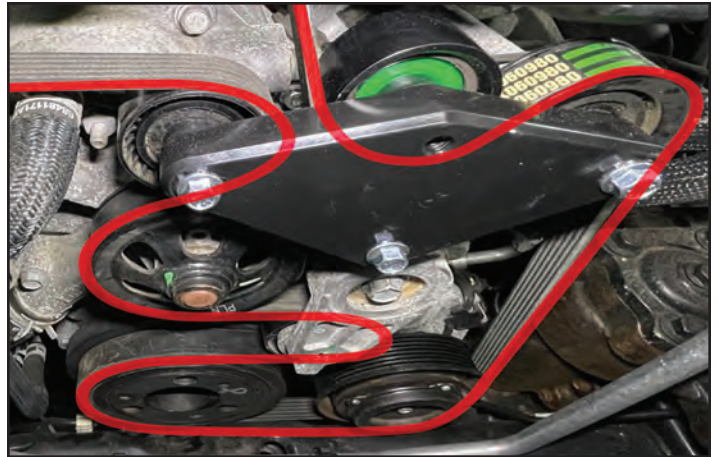

183. Re-install the factory coolant fan shroud assembly behind the radiator and secure it using the original bolts.

Re-connect the fan wiring harness at the RH front corner of the shroud.

Clip the hardshell connector back into the shroud to secure it.

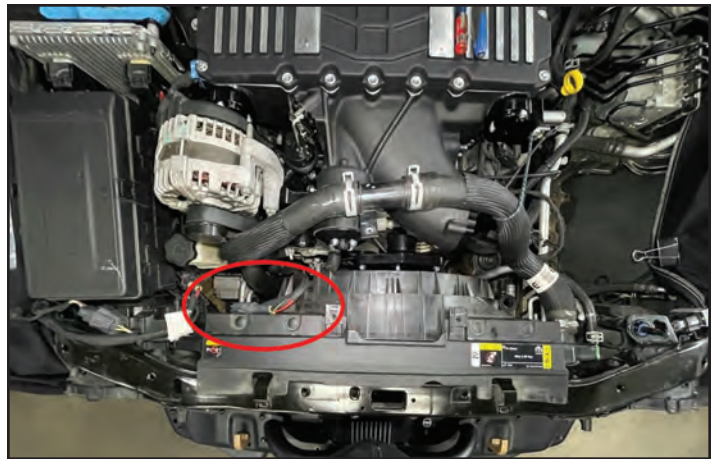

184. Re-install the factory bolt through the upper radiator hose bracket into the middle of the fan shroud to secure the hose in place.



185. Remove the 90 degree rubber end from the factory fuel vapor line as shown.



186. Install the 023F hose onto the end of the fuel vapor line.



Section 12: Hose Routing

187. Route the factory fuel vapor line (highlighted in green) along the LH side of the supercharger, under the oil fill adaptor as shown. The hose can be trimmed to length as required so that it routes neatly toward the upper port at the LH front corner of the inlet as shown.

Install and fully seat the 023F hose onto the upper port.



188. Select the 023E brake booster hose from the kit (highlighted in green) and pre-install a MU17 constant tension clamp (shown below) onto each end of the hose. Install the end with the 90 degree pre-formed bend onto the T-fitting at the back of the supercharger then route the opposite end around the LH side of the supercharger.



189. Connect the opposite end of the 023E hose (highlighted in green) to the 3/8" fitting at the left front corner of the supercharger.

Secure the hose to the fitting using the constant tension clamp.



190. Reconnect the factory fuel line to the connector on the LH side of the supercharger. Ensure it is fully seated and will not pull back out.



191. Fasten the lock back over the fuel line connector ensuring it snaps into place against the connector.



Section 13: Oil Separator Hose Routing

192. Select the length of bulk 3/8" hose from the kit (highlighted in green).

Install one end onto the bottom of the oil separator, ensuring it is fully seated.

Route the hose along the LH side of the supercharger, toward the oil fill adaptor.



193. Cut the hose (highlighted in green) to the appropriate length then install it onto the 45 degree barbed fitting at the back of the oil fill adaptor.



194. Use this photo as a reference for the location of the hoses shown in the next two photos.

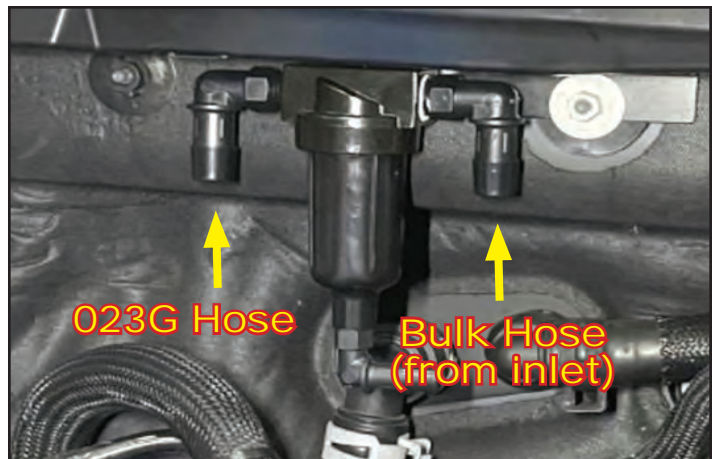

195. Route the length of bulk PCV return hose that was pre-installed to the inlet at the front of the supercharger in a previous step, around the RH side of the supercharger and over to the oil separator that is mounted on the fire wall. Install the hose onto the driver's side fitting of the oil separator ensuring it is fully seated.



196. Route the 023G pre-formed hose that was also previously installed from the PCV valve on the RH side of the supercharger, over to the passenger side fitting on the oil separator. Install the 023G hose to the passenger side fitting ensuring it is fully seated.



197. Here you can see all the connections at the oil separator.



198. Select the intercooler reservoir bracket PN 65-26-61-039 and secure it onto the LH side of the supercharger housing using (2) M8 X 16mm long bolts PN 71-08-12-016.



199. Select the intercooler reservoir PN 68-01-03-019 and secure it onto the bracket using (3) M6 X 16mm long bolts PN 71-06-10-016 (highlighted in green).

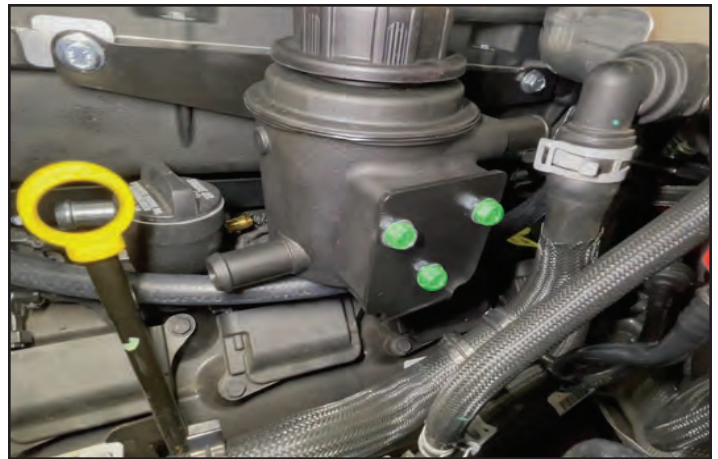

Temporarily install the reservoir cap PN 68-01-03-007.

200. Bend the dipstick tube slightly toward the drivers side of the vehicle. This will allow for additional hose clearance to the reservoir.



Section 14: Intercooler System Hoses

201. We will now begin routing and installing the 023A, 023B and 023C intercooler system hoses as per the diagrams shown here (full page versions are contained in Appendix 2 at the back of this manual).

Once each hose has been set in place, pre-install a $\frac{3}{4}$ " constant tension clamp on each end (see the following slides). A small amount of lubricant (supplied in the kit) can be applied to the hose I.D. to reduce installation effort.

202. Here is the second intercooler system diagram. A larger version of this is included at the back of this manual.

203. Install the 023A coolant hose (highlighted in green) to the lower port on the RH side of the supercharger as shown.

Ensure it is fully seated then secure it with the $\frac{3}{4}$ " constant tension clamp.

204. Working from the LH side of the vehicle, carefully route and install the opposite end of the 023A coolant hose (highlighted in green) to the lower port charge air cooler on the supercharger as shown.

Ensure it is fully seated then secure it with the $\frac{3}{4}$ " constant tension clamp.

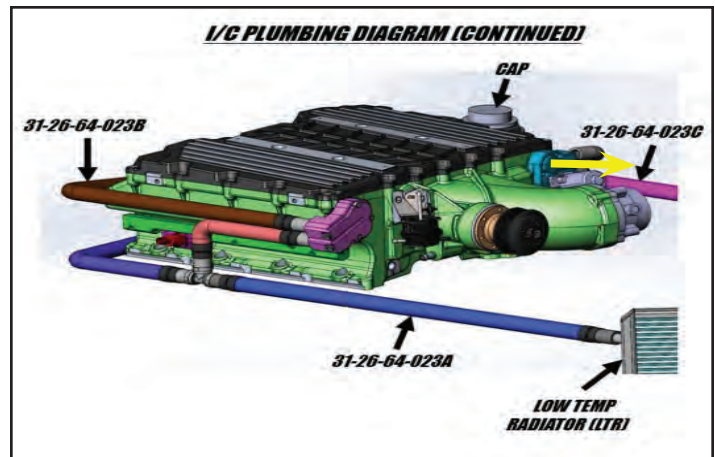
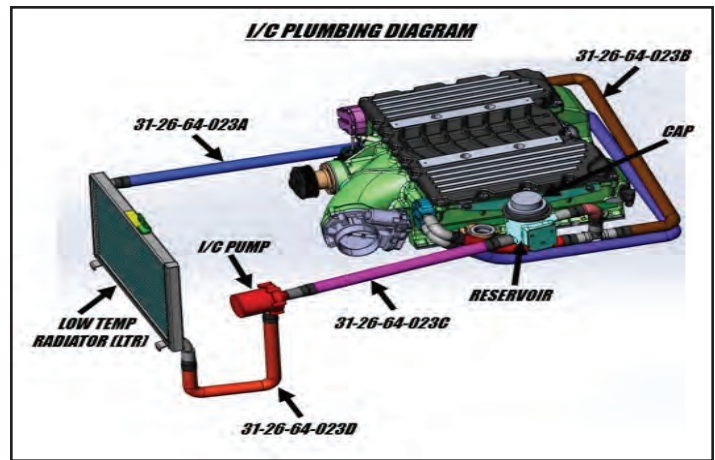

205. Set the 023B hose (highlighted in green) into place, routing it around the back of the supercharger and along each side as shown.



206. Pre-install 3/4" clamps at all 3 ends of the 023B hose. Working from the RH side of the vehicle, install the hose onto the upper fitting and secure it with the clamp as shown.



207. Working from the LH side of the vehicle, finish routing the 023B hose (highlighted in green) under the coolant reservoir and toward the fitting at the front corner of the supercharger.

Connect the short 90-degree hose to the rear of the coolant reservoir, securing it with a constant tension clamp.



208. Install the remaining section of the 023B hose to the upper fitting at the LH front of the supercharger and secure it with the constant tension clamp.



209. Select the 023C hose (highlighted in green).

Pre-install a $\frac{3}{4}$ " constant tension clamp onto each end then route and install the 023C hose onto the front of the coolant reservoir and the intercooler pump as shown.

Secure the hose at both ends using the clamps.



210. Connect the previously installed IAT jumper harness to the factory connector at the LH front of the engine.

Bundle up any extra wire and zip tie it in place by the front of the LH valve cover.

Secure the bundle to the front of the valve cover using the original fir tree connector on the factory harness.



211. Re-install the LH headlight, secure it with the (3) factory bolts then plug the wiring harness in at the back of the housing.

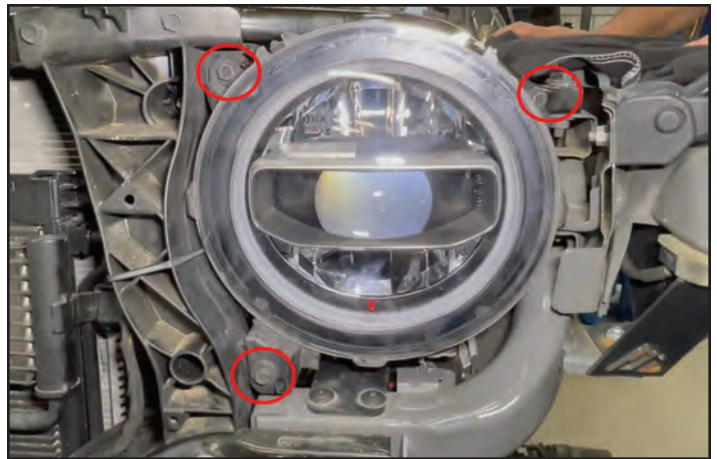

212. Drill a $\frac{1}{4}$ " hole in the LH factory closeout panel at the green "+" location shown.

Re-install the closeout panel back into place on the vehicle.

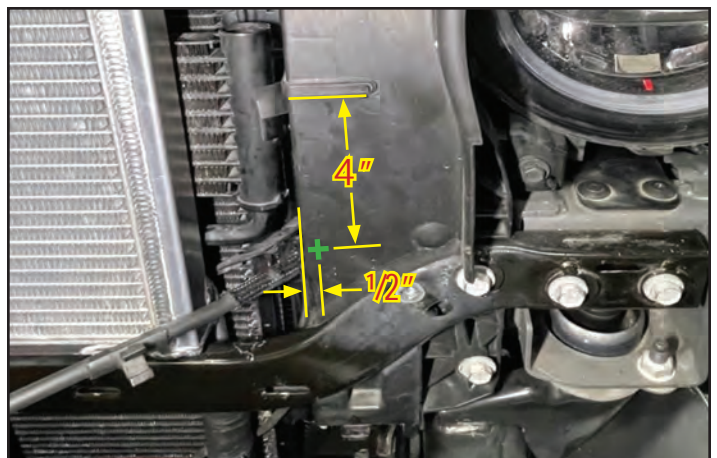

213. Using a ¼" push pin (PN: 69-99-05-019) from the kit, secure the factory ambient air temp sensor into place in the hole that was made in the closeout panel.

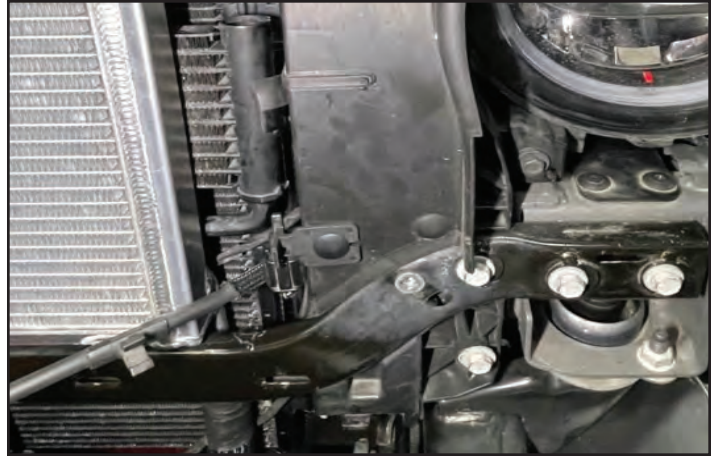

214. A section of the RH factory closeout panel must be trimmed in the area shown to allow for clearance to the coolant hose in the top corner.

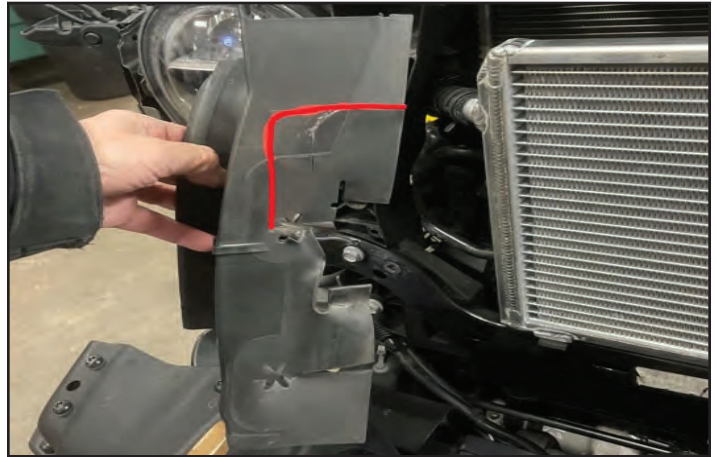

215. Carefully trim the closeout panel as shown using scissors or a knife. Trial fit it back into the vehicle verifying it does not contact the coolant line.

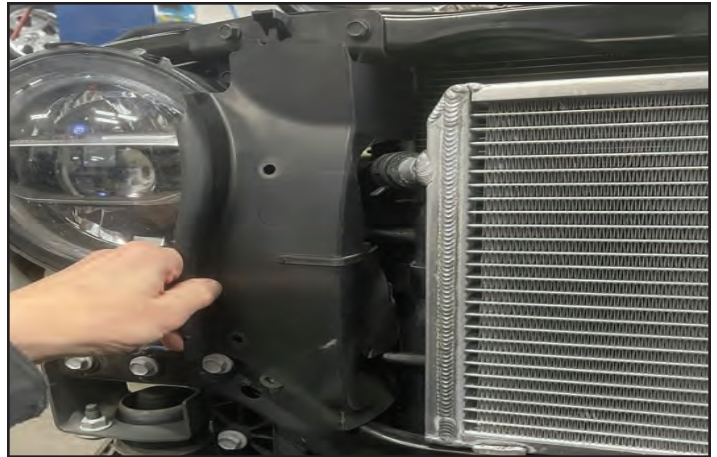

216. Re-install the closeout panel back into place on the vehicle, ensuring the tab on the top locates back into the slot.

Secure the panel using the factory push pins in the original holes.

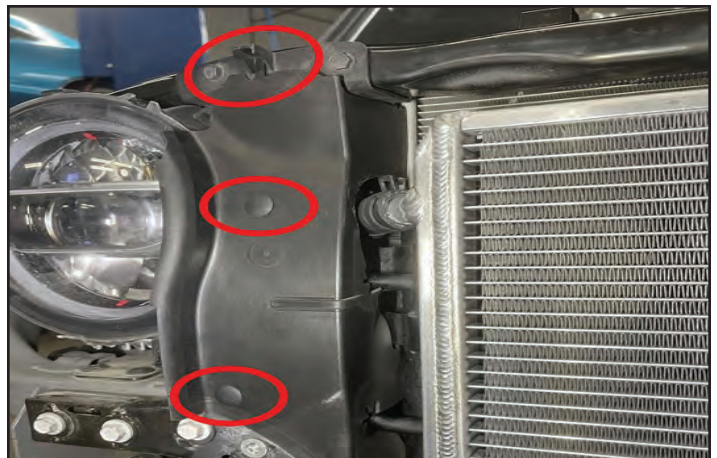

217. Gather the (4) M6 X 40mm long bolts PN 71-06-10-040 and **apply Loctite 242 to them as shown.**



218. Ensure that the OEM gasket has been transferred to the adapter plate as shown.



219. Install the throttle body onto the adapter plate on the supercharger inlet with the M6x40mm bolts from two steps ago. **Zero torque the bolts in a criss-cross pattern then final torque the bolts 106 in-lbs.**



220. Route the factory ETB wiring harness around the back of the throttle body and up toward the connector. Install the connector ensuring it is fully seated.



221. Install the factory air box ensuring it is fully seated back into the rubber grommets.

Secure the airbox by tightening the fastener in the location shown



222. Select the 023H hose from the kit (highlighted in green). Note that one end of it has a smaller I.D. than the other. Harvest (1) constant tension clamp from the factory hose and pre-install it over the larger end of the 023H hose.

Install the large end of the 023H hose to the port on the airbox and secure it with the clamp.

Install the opposite end of the 023H hose onto the tube at the oil fill adaptor (no clamp is required at this location).



223. Harvest the gear clamps from the factory clean air tube. Install them onto the new clean air tube PN 31-26-64-023J then install the clean air tube in between the airbox and throttle body. Note the orientation tab on the airbox. Index the molded notch in the clean air tube into the tab. Tighten the gear clamps at each end of the clean air tube securely.

Note: the factory intake air temperature sensor remains installed in the airbox but will not be connected.



224. Select the MAP sensor jumper harness PN 82-55-80-042.

Install it into the factory connector located at the back of the engine compartment.



225. Route the jumper harness to the new MAP sensor located at the LH rear corner of the supercharger housing.

Install the jumper harness into the MAP sensor, ensuring it is fully seated.

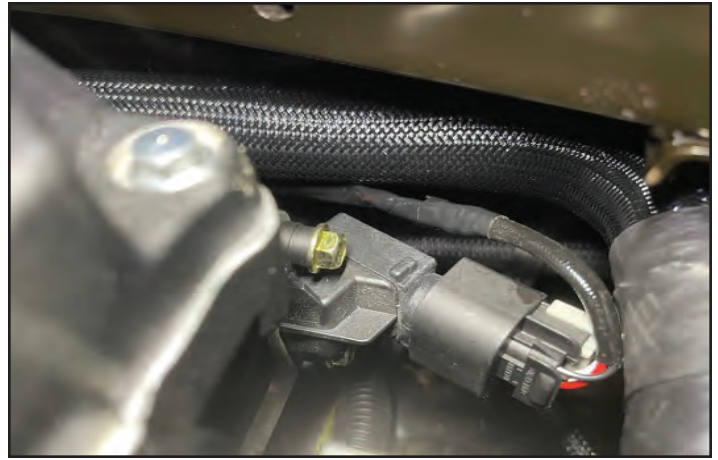

226. Re-connect the LH headlight harness and front camera harness (if equipped) then reinstall the front grill assembly with/push pins at the 6 arrow locations.



227. Re-install the LH and RH foam seals in each corner of the engine compartment above the headlights (LH side shown, RH side similar).

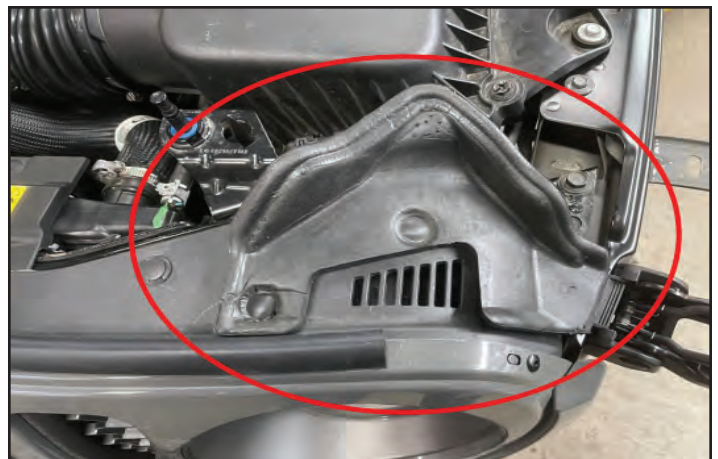

228. Reconnect the wires to your battery terminals. Ensure that all three connections are tight.



Make sure that you have followed the steps at the beginning of this manual and in the addendum manual to load the proper Supercharger calibration to your vehicle's ECM.



Section 15: Engine Radiator and Intercooler System Filling

229. **If air is present in the system, the intercooler pump will automatically shut off leading to excessively high intake air temperatures which can cause engine damage. Therefore we highly recommend using a cooling system vacuum purge and refill kit as shown here to properly fill the system.**

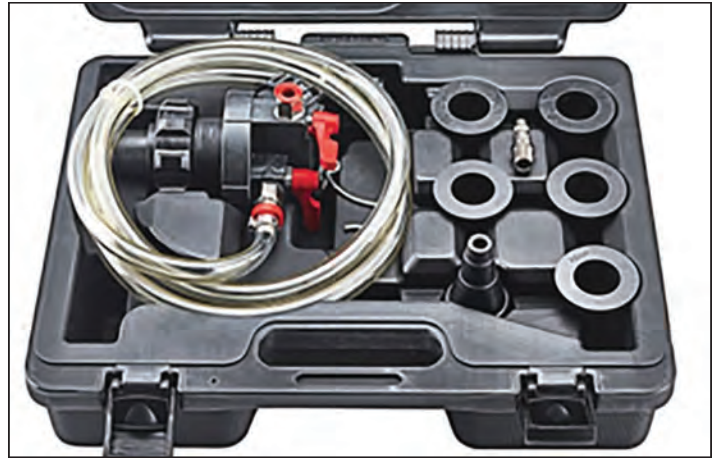

230. **Note: The photos shown are of a different supercharger kit but the process is the same.** Remove the cap from the degas bottle and using the correct adapter, connect the “Evac” tool to the filler neck.



231. **Consult your owner's manual and select the correct coolant for your vehicle. Failure to select a compatible coolant may cause contamination of the coolant system and potentially lead to overheating issues.** Connect the shop air to the tool, and submerge the fill hose into the fill coolant container.



232. Pull a partial vacuum on the system and close the vacuum line.



233. **Refill BOTH the intercooler AND engine coolant systems.** Slowly open the fill valve and purge all the air out of the fill hose to avoid any air being introduced during the fill process, and once the coolant gets to the valve close it.



234. Pull a vacuum until all of the air is out of the system. All of the intercooler system hoses will be fully collapsed and the needle will stop rising. Close the vacuum valve and let the system sit for a few minutes and make sure the vacuum holds. This will help insure that the system has no leaks. **If the gauge loses vacuum, YOU HAVE A LEAK somewhere in the system.** This leak must be found and repaired as it could be a rolled O-Ring on the extension tubes from the coolant manifold to the CAC (Charge Air Cooler). If an O-Ring is leaking then the coolant from this system can leak into the engine and cause damage.



235. Once all the vacuum is gone, remove the tool from the tank, but do not install the cap yet. At this point start the engine and make sure the coolant is flowing vigorously through the bottle. (The pump takes a few seconds to ramp up so be patient). Once the coolant is flowing, shut the engine off and let the coolant settle. Once the coolant has settled, fill the bottle so that the level is just above the inlet to the tank.



236. If you are unable to use a vacuum purge and refill kit you can follow the directions in the next step to fill your system manually.

Continued on next page.

237. Option #2: Manual filling.

- a. Using a coolant funnel attach the correct adaptor to the intercooler reservoir.
- b. Connect the funnel to the adaptor.
- c. Fill the funnel to the $\frac{1}{2}$ way mark with a 50/50 mixture of the same coolant approved by the OEM. If you don't have the funnel shown make sure the reservoir tank is full.
- d. Remove the trigger wire from the fuse in the fuse box and touch it directly to a 12 volt source. While the pump runs you need to massage the 31-19-36-011C hose to try and force the air up out of the system. Repeat touching the trigger wire to the 12v source for the duration of the pump running.
- e. As the level drops in the tank, make sure that you pause and refill the tank to prevent any air from getting back into the system.
- f. Once coolant starts flowing keep the trigger wire to the 12V supply, add coolant as needed until the coolant flows consistently.
- g. Remove the trigger wire from the 12v source. Fill the tank back up to above the inlet port to the tank, put the cap on, and re-connect the trigger wire to the fuse in the fuse box.
- h. Start the vehicle and verify the intercooler system is running.



238. Start the vehicle for 5 seconds and shut it off. Check for fuel leaks and supercharger belt alignment. Check the intercooler reservoir level. Now start your engine and let it run for a few minutes to let it get to operating conditions. Let the engine cool down, and check all your levels again.



Section 16: Final Testing

239. Test drive vehicle for the first few miles under normal driving conditions. **Do not perform any wide open throttle runs.** Listen for any noises, vibrations, engine misfire or anything that does not seem normal. The supercharger does have a slight whining noise under boost conditions, which is normal. Check and top off the intercooler reservoir as needed.

**TURN OFF Traction Control
For Off Road/Racing use.**



240. After the initial test drive gradually work the vehicle to wide open throttle runs, listen for any engine detonation (pinging). If engine detonation is present let up on the throttle immediately. Most detonation causes are low octane gasoline still in the tank.

If you have questions about your vehicles performance, please check with your installation facility.

After you finish your installation and road test your vehicle, please fill out the warranty registration. This can be found on our website.



241. Clean the surface at the arrow location and apply the provided "Use Premium Fuel Only" label as shown.

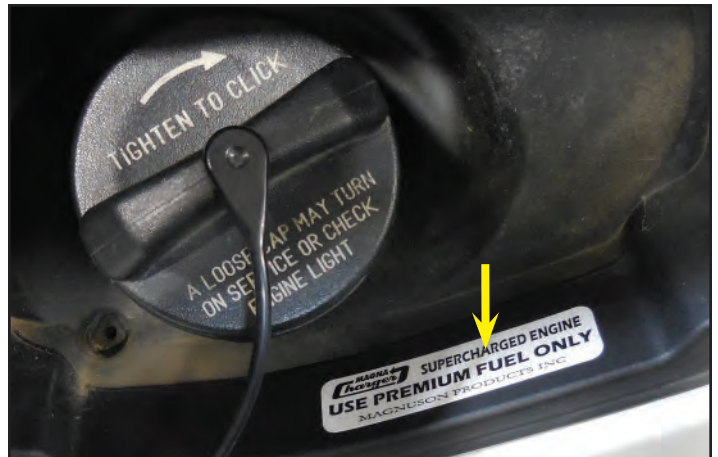

Section 17: Hydro Guide Modification

242. Loosen (6) 8mm captive fasteners securing the hydro guide to the underside of the hood in the locations shown.

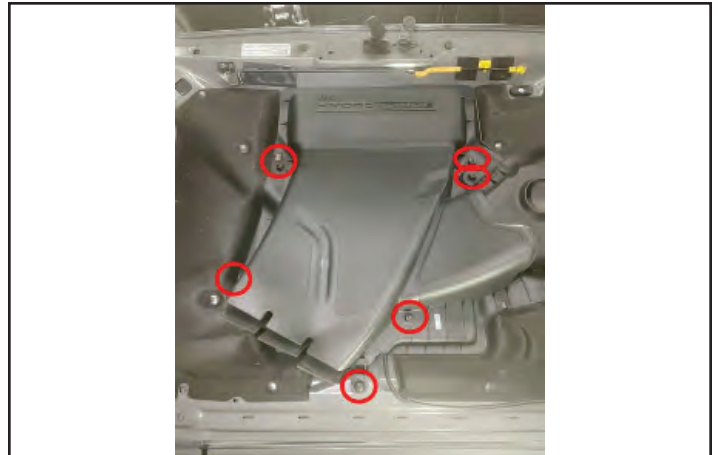

243. Angle the driver's side of the hydro guide downward then slide it out of the retaining tab at the location shown.



244. Loosen (1) 8mm captive fastener at the location shown then slide the second half of the hydro guide upward to release it from the 3 retention clips located at the bottom.

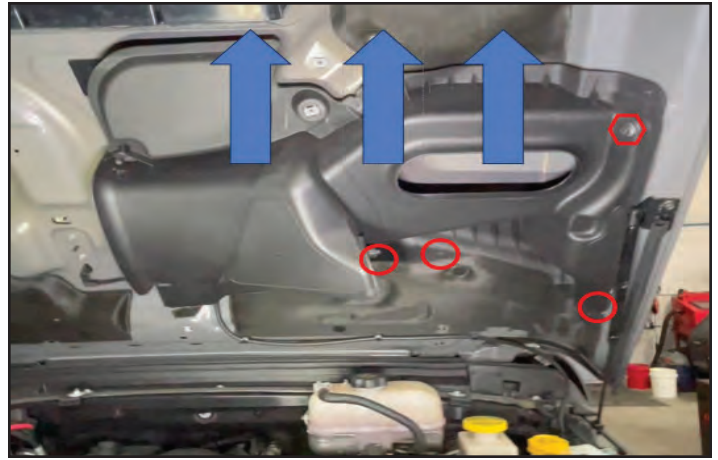

245. Take the section of factory hydro guide shown over to a suitable work area. Using a grease pencil or crayon, outline the green highlighted area.



246. Using a small pneumatic saw or Dremel cut-off wheel, cut the hydro guide in the highlighted area.



247. Drill out (4) plastic rivets in the locations shown then remove the plastic insert that is secured by the rivets.



248. Trim or grind off the remainder of the plastic rivets in all (4) places.

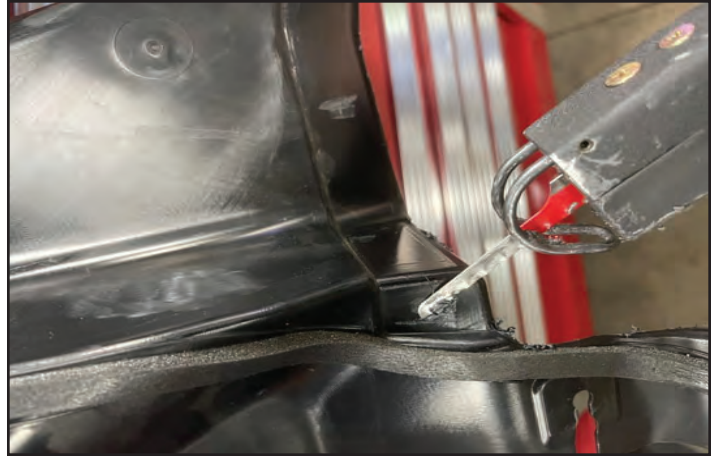

249. Make an additional cut in the location shown.

Trim off any excess plastic material and radius all corners to clean up sharp edges.



250. Re-install the modified hydro-guide, ensuring it engages into the plastic clips at the bottom. Secure it with the original fastener.



251. Assemble the supplied M6 panel nut, star washer, M8 nut and M6x30mm flange head bolt as shown. (The M6x30mm flange head bolt will be black). Apply a light coat of grease to the panel nut in the arrow area.



252. Insert the assembly from the last step into the location circled on the hood below and the closeup photo to the right.

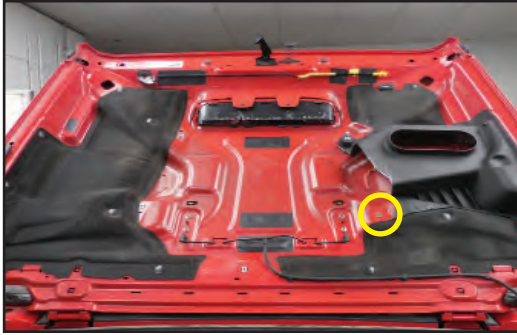

253. Insert the assembly into the hood with a small hammer..



254. Hold the M8 flange nut with a wrench and tighten the M6x30mm flange nut to allow the M6 panel nut to flare out behind the panel and secure itself.



255. Remove the M6 x30mm flange head bolt, M8 flange nut, and star washer after the panel nut is fully secured, and does not spin.



256. Gather the (6) M6x30mm bolts (PN 71-06-10-030-BL) shown here and install the supplied washers (PN 75-00-06-020-BL).
Apply Loctite 242 to the fasteners.

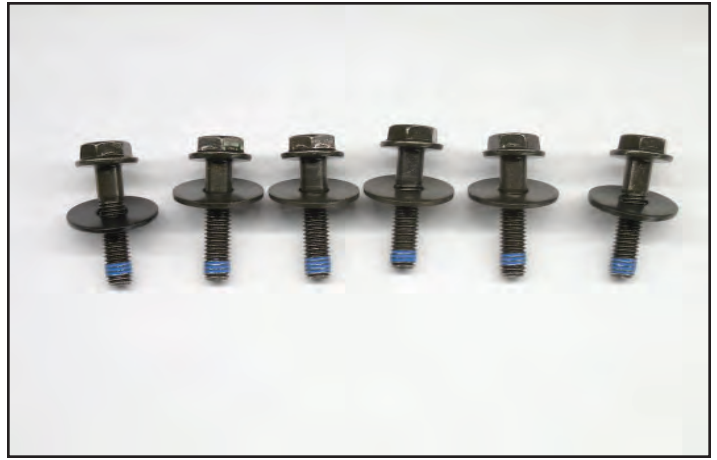

257. Install the new Magnuson hydro guide into place under the hood with the fasteners from the last step. The bolts and washers are shown with arrows in this image, and are silver to allow better visibility in the photo.



Appendix

392 Jeep Supercharger Torque Sequence

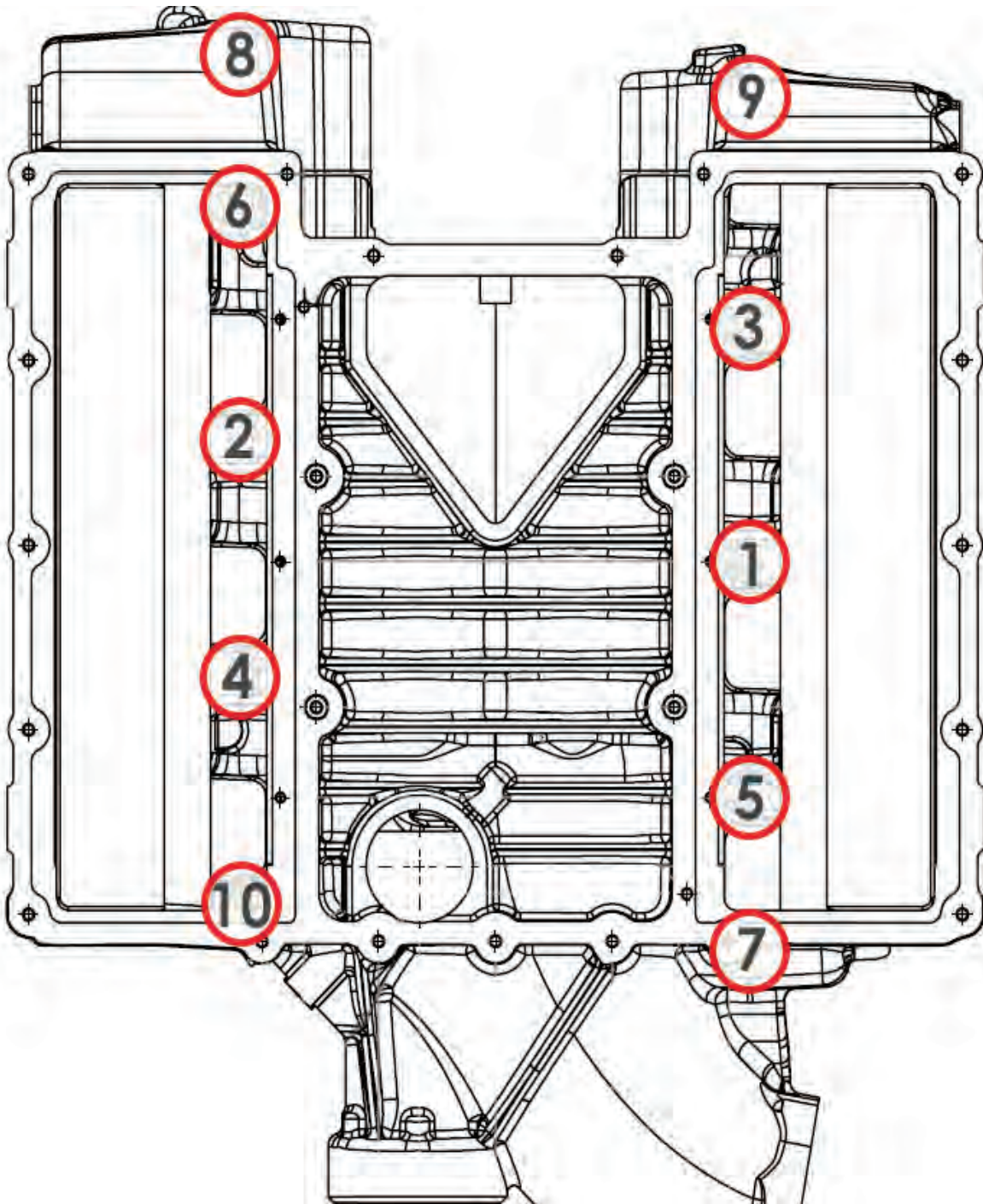

Supercharger Housing To Engine:

- Zero Torque all 10 fasteners
- Pre-torque all 10 fasteners to 53 in-lbs in sequence.
- Final torque all 10 fasteners to 106 in-lbs in sequence.

Appendix

392 Jeep Supercharger Lid Torque Sequence

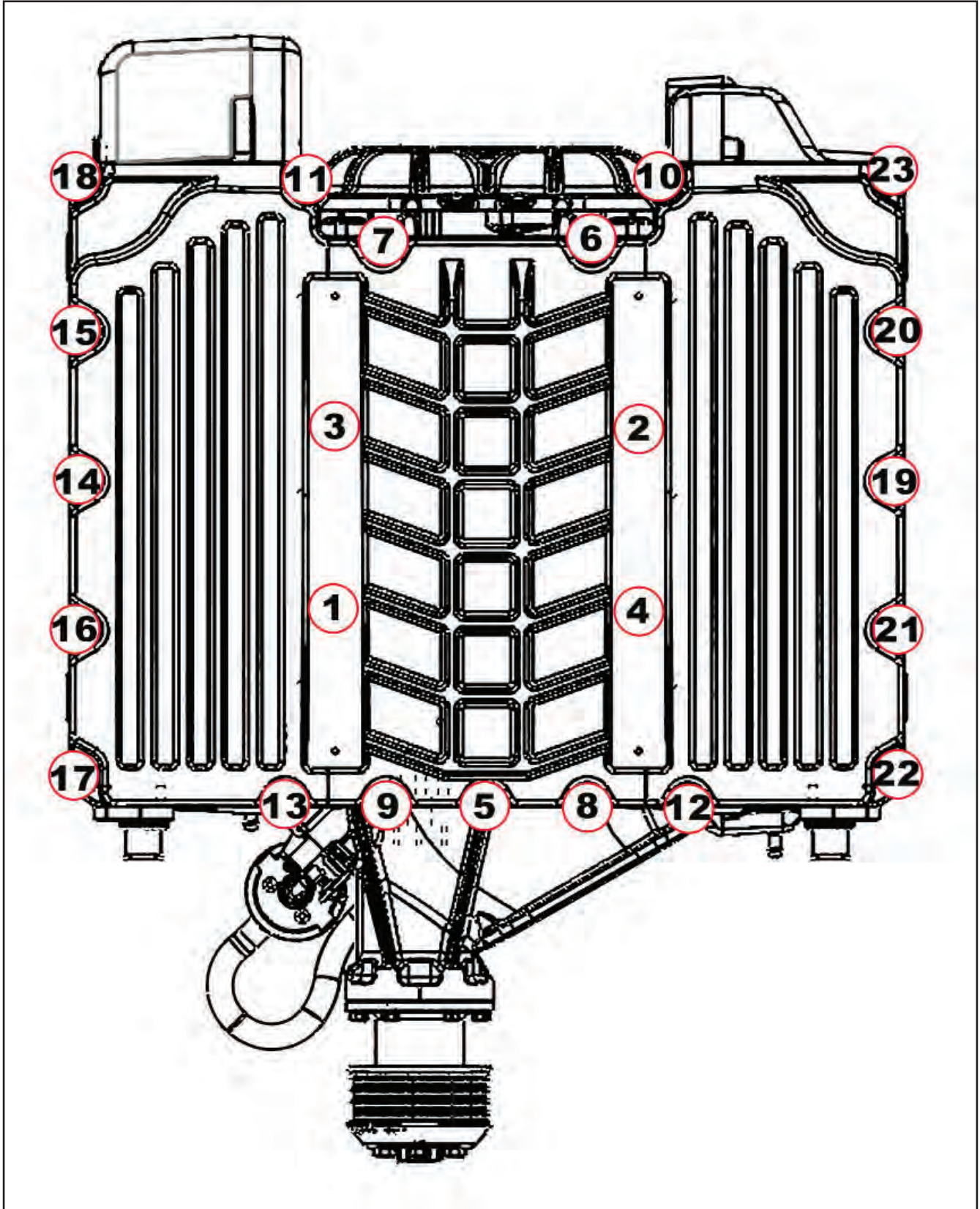

Lid to Supercharger Housing: 106in-lbs
(This image is from our LT1 kit but the sequence is the same)

Appendix

392 Jeep Serpentine Belt Routing Diagram

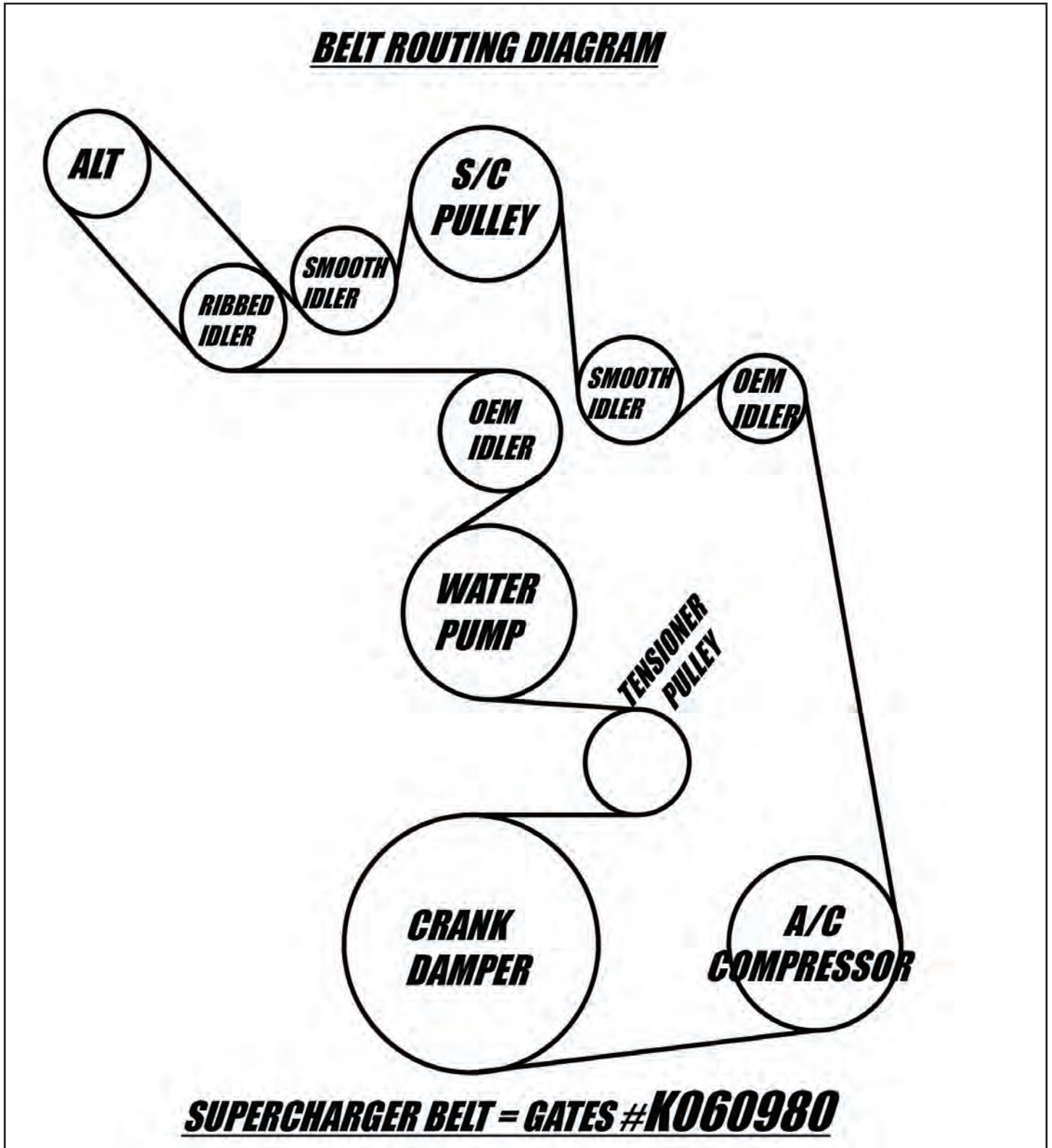

Appendix

392 Jeep FEAD Bracket Assembly

THE INFORMATION CONTAINED IN THIS DRAWING IS THE SOLE PROPERTY OF MAGNUSON PRODUCTS. ANY REPRODUCTION IN PART OR WHOLE WITHOUT THE WRITTEN PERMISSION OF MAGNUSON PRODUCTS IS PROHIBITED.

BRACKET-IDLER, MAGNUM HEMI - 21+ JEEP 392

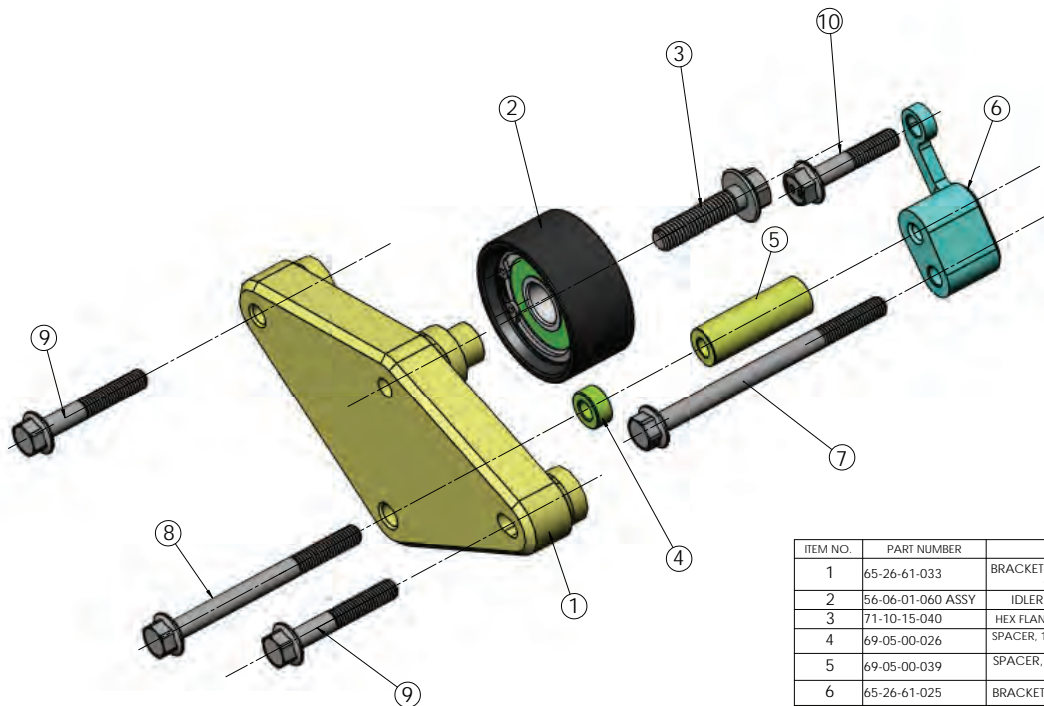

ITEM NO.	PART NUMBER	DESCRIPTION	QTY
1	65-26-61-033	BRACKET-IDLER, MAGNUM HEMI - 21+ JEEP 392	1
2	56-06-01-060 ASSY	IDLER - PULLEY ASSEMBLY	1
3	71-10-15-040	HEX FLANGE BOLT, M10-1.50 X 40	1
4	69-05-00-026	SPACER, 16MM OD X 8MM ID X 7.3 LG	1
5	69-05-00-039	SPACER, 16MM OD X 8MM ID X 47.3MM LG	1
6	65-26-61-025	BRACKET, SUPPORT, FEAD IDLER	1
7	71-08-12-110	HEX FLANGE BOLT, M8-1.25 X 110	1
8	71-08-12-090	HEX FLANGE BOLT, M8-1.25 X 90	1
9	71-08-12-050	HEX FLANGE BOLT, M8-1.25 X 50	2
10	71-08-12-040	HEX FLANGE BOLT, M8-1.25 X 40	1

MAGNUSON SPECIAL CHAMBERLAIN DIVISION 1500 KINCAID DRIVE VENTURA, CA 95003 (805) 642-8833	DATE: 12/21/23 DRAWN: ALJ/MSK CHECKED:	MAGNUSON PRODUCTS 1500 KINCAID DRIVE VENTURA, CA 95003 (805) 642-8833
	PART NO: 65-26-61-033 DATE ENG: 12/21/23 SCALE: 1:1 SHEET NO: 1 TOTAL SHEETS: 1	BRACKET-IDLER, MAGNUM HEMI - 21+ JEEP 392

Appendix

392 Jeep Intercooler Hose Routing Diagrams

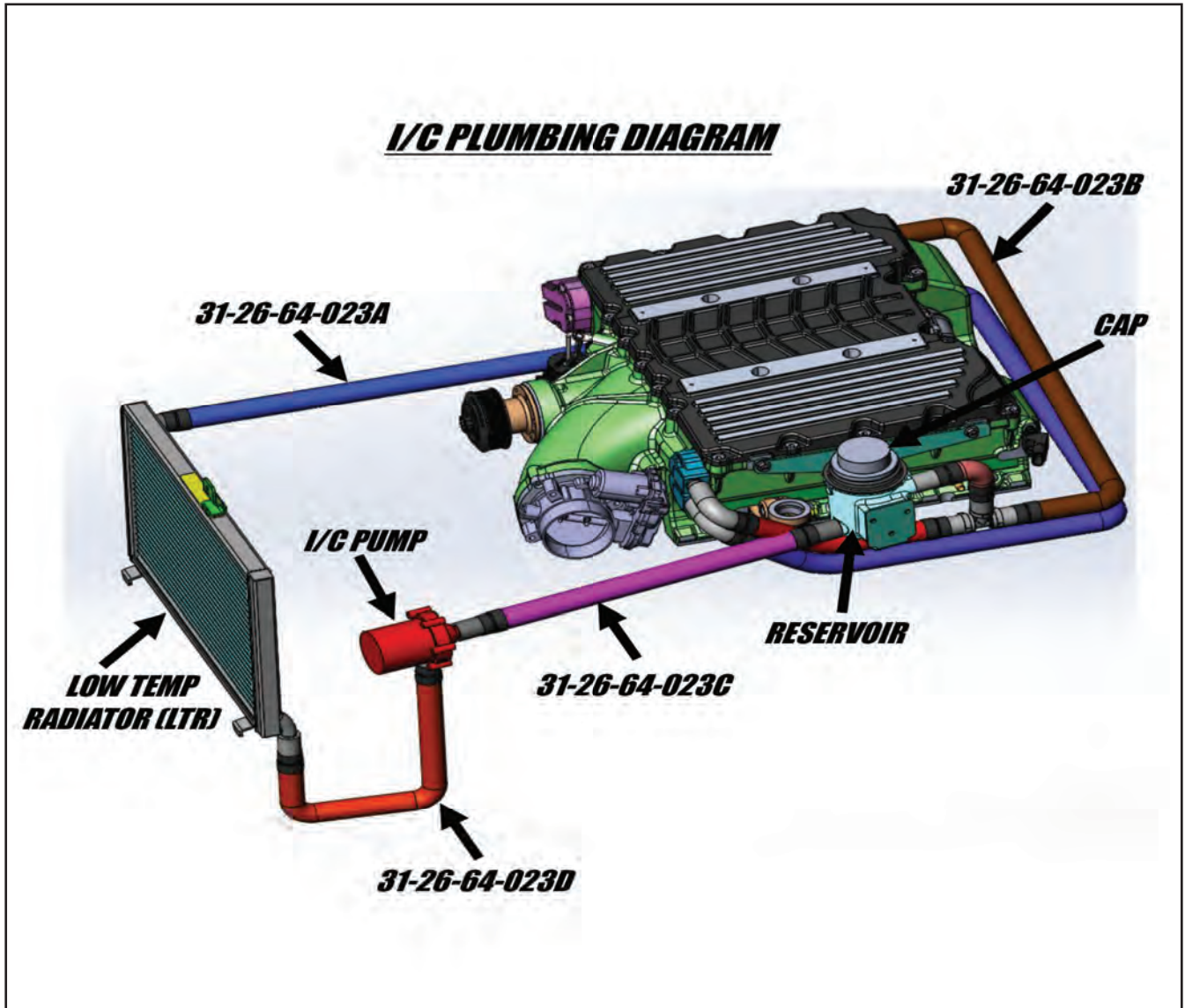

Appendix

392 Jeep Intercooler Hose Routing Diagrams

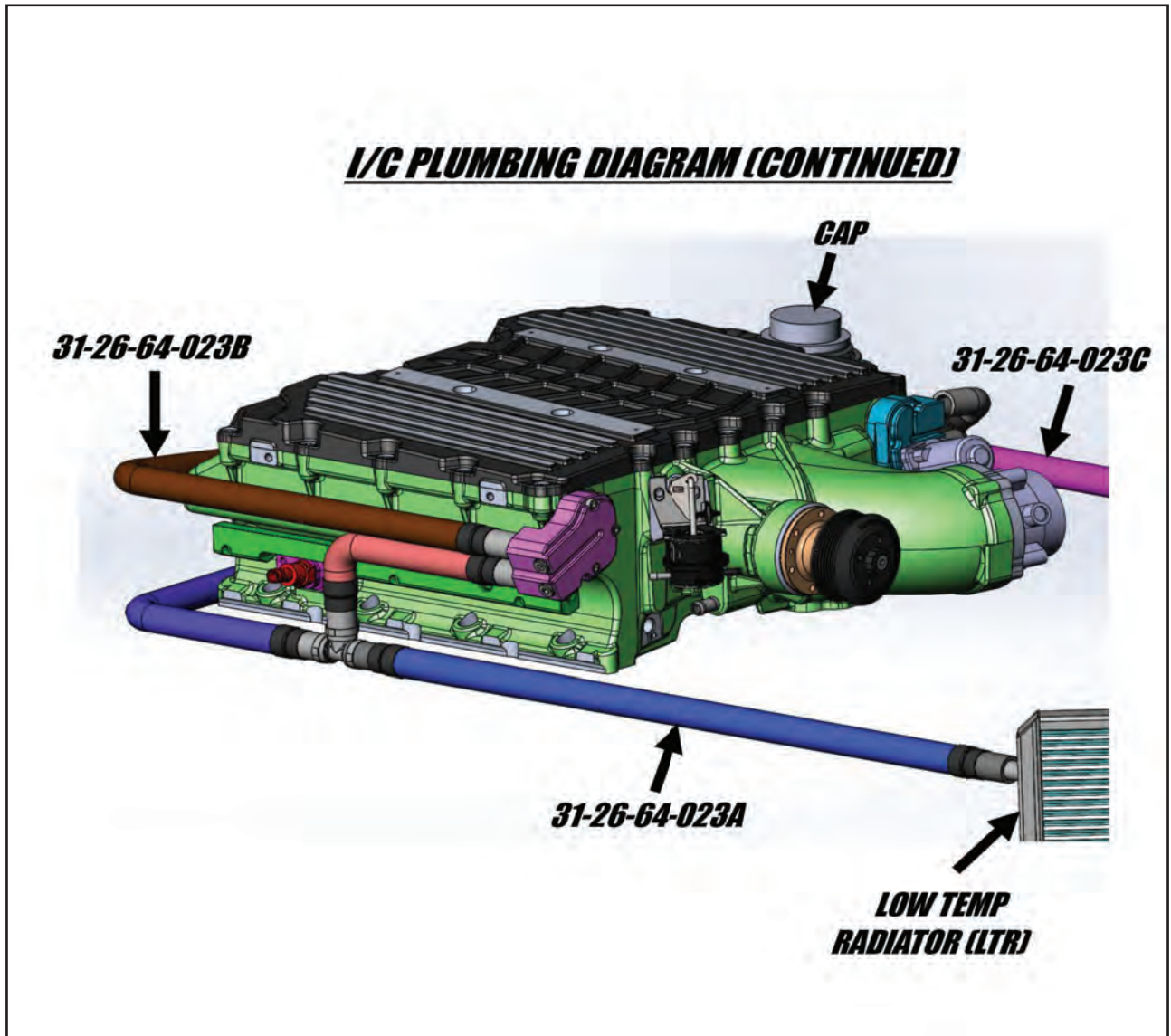



Please enjoy your "Magnuson SuperCharged" performance responsibly.

*** PREMIUM 91 OCTANE GASOLINE FUEL REQUIRED ***

**TURN OFF Traction Control
For Off Road/Racing use.**

MAGNUSON
SUPERCHARGERS