

MAGNUSON

SUPERCHARGERS

Installation Instructions for:
Magnum DI Supercharger System
2017-2024 LT4 ZL1 Camaro
2016-2019 Cadillac CTS-V



Step-by-step instructions for installing the best in
supercharger systems.

*** PREMIUM GASOLINE FUEL REQUIRED ***

ATTENTION!

Your **MAGNUSON SUPERCHARGER** kit
is sensitive to corrosion!

Use only the vehicle manufacturer
recommended coolant for your engine in
the intercooler system as well.



Magnuson Products LLC
1990 Knoll Drive, Bldg A, Ventura, CA 93003

(805) 642-8833

magnusonsuperchargers.com

INSTALLATION MANUAL

Magnuson Supercharger Magnum DI Kit

GM 6.2 Liter Engine

2017-2024 Chevrolet Camaro LT4 ZL1 and 2016-2019 Cadillac CTS-V

Please take a few moments to review this manual thoroughly before you begin work: Make a quick parts check to be certain your kit is complete (see Bill of Material (BOM) parts list inside the accessory box). If you discover shipping damage or shortage, please call our office immediately. Take a look at exactly what you are going to need in terms of tools, time, and experience. Review our limited warranty with care. When unpacking the supercharger kit DO NOT lift the supercharger assembly by the black plastic bypass actuator. This is pre-set from the factory and can be altered if used as a lifting point!

Caution: Relieve the fuel system pressure before servicing fuel system components in order to reduce the risk of fire and personal injury. After relieving the system pressure, a small amount of fuel may be released when servicing the fuel lines or connections. In order to reduce the risk of personal injury, cover the regulator and fuel line fittings with a shop towel before disconnecting. This will catch any fuel that may leak out. Place the towel in an approved container when the job is complete.

Use only premium gasoline fuel, 91 octane or better.

Magnuson Superchargers recommend that you run a minimum of one (1) tank of premium fuel through your vehicle prior to installation of the system to prevent any possible damage that may occur due to running the supercharged engine on lower octane fuel.

Magnuson Superchargers systems are designed for engines and vehicles in “GOOD” mechanical condition. Magnuson Superchargers recommend that a basic engine system “Health Check” be performed prior to the installation of this supercharger system. Be sure to check for any pending or actual OBDII codes and fix/repair any of the stock systems/components causing these codes. If there are codes prior to the installation they will be there after the installation.

Magnuson Superchargers also recommends the following services to be performed on your vehicle before starting and running the vehicle post supercharger system installation:

- Fuel Filter change
- Engine oil and filter change using brand name oil (organic or synthetic) and filter

Note: It is VERY IMPORTANT to use the factory specified oil viscosity. The original equipment manufacturer has selected this grade of oil to work with your other engine systems such as hydraulic chain tensioners and variable cam controls. Deviation from this specification may cause these systems to fail or not function properly. Please refer to your owner’s manual for the recommended oil viscosity for your engine and application.

- On newer vehicles not requiring new spark plugs it is important to verify the spark plug air gap.

On older vehicles Magnuson Superchargers recommend these additional services to be performed:

- New spark plugs with the air gap set at the factory specifications OR new specifications if required by the installation manual.
- Coolant system pressure test and flush. **NOTE: YOU MUST USE GM SPECIFIED COOLANT MIXTURE.**

Non “Magnuson Approved” calibrations or “tuning” will Void ALL warranties and CARB certification.

Tools Required

Metric wrench set
1/4" - 3/8" and 1/2" drive metric socket set (standard & deep)
3/8" and 1/2" drive ft-lbs and in-lbs torque wrenches
Phillips and flat head screwdrivers
1/2" breaker bar
Serpentine belt wrench
Fuel line quick disconnect tools (included in kit)
Funnel
Hose cutters
Hose clamp pliers
Safety glasses
Hammer
Nut driver
Compressed air
Heat gun
Metric Allen socket set 3/8 drive
Metric Allen wrenches
Torx socket set 3/8 drive
Plastic pry bar
Oetiker clamp pliers
Rotary Cutting Tool or Hacksaw
Band Saw

Contact Information:

Magnuson Superchargers
1990 Knoll Drive, Bldg A
Ventura, CA 93003

Sales/Technical Support Line (805) 642-8833
Websites www.magnusonsuperchargers.com
Email sales@magnusonsuperchargers.com

Table of Contents

Section 1:	Tuning your Vehicle Computer and Initial Steps	5
Section 2:	Removal of Factory Supercharger and Accessories	6
Section 3:	Fuel Line Replacement and Valve Cover Modification	19
Section 4:	Preparing the Supercharger for Installation	25
Section 5:	Coolant Line and Air Duct Installation	38
Section 6:	Coolant Fill and Final Testing	44

Section 1: Tuning your Vehicle Computer and Initial Steps

Any reference to left or right side of vehicle is given from driver's seat perspective.

1. If your kit has a provided handheld tuner follow the instructions in the provided pamphlet to install your tune. **WARNING: DO NOT BEGIN THE INSTALLATION BEFORE OBTAINING YOUR NEW CALIBRATION FILE. IN SOME CASES, ESPECIALLY WITH NEWER VEHICLES, THIS STEP CAN TAKE SEVERAL DAYS AND YOUR VEHICLE WILL BE IMMOBILIZED WHILE YOU WAIT FOR THE NEW CALIBRATION FILE.** Your handheld tuner may not match the one shown.
2. Your Intercooler system is sensitive to corrosion. It's very important to use the OEM recommended coolant mixture in your supercharger system as well.
3. Your system requires the use of minimum 91 Octane gasoline fuel. This system is **not** compatible with E85 fuel.
4. Remove the negative cable from the battery with a 10mm wrench. The battery is located in the right rear of the cargo compartment behind a small door.

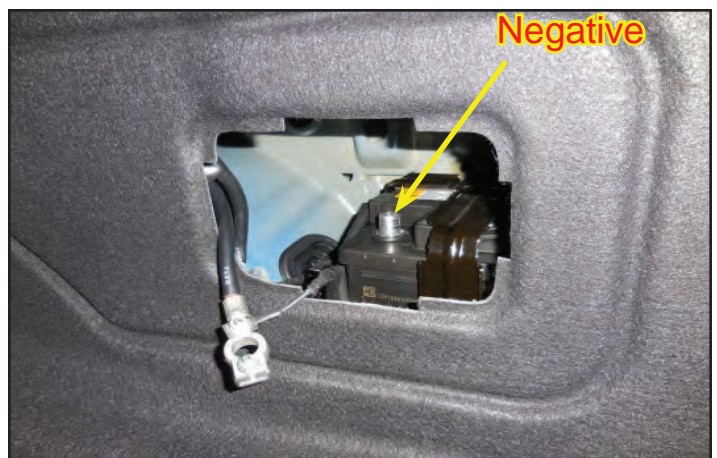

5. Place a rag, or other appropriate insulator over the negative terminal to prevent accidental connection.



6. Place a rag over the rear hatch latch to prevent locking.



Section 2: Removal of Factory Supercharger and Accessories

7. Remove the 5 screws shown with arrows that secure the airbox lid.

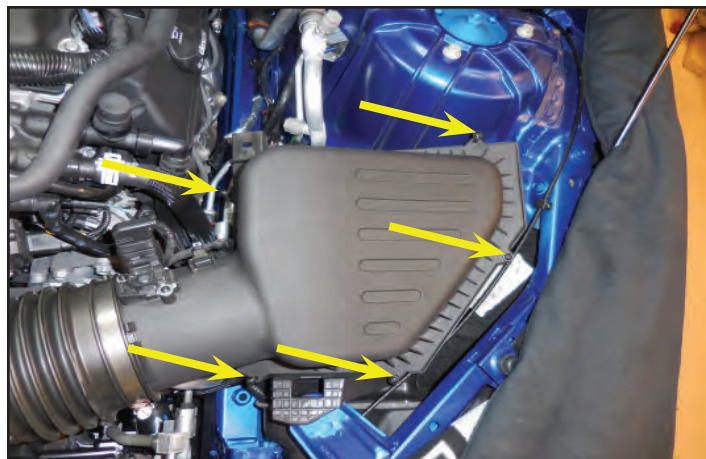

8. Loosen the two hose clamps for the intake duct using an 8mm nut driver or standard screwdriver. Also at this time remove the PCV hose shown at the green arrow location by pressing inwards on the gray buttons and pulling it out.



9. Here is a close-up of the PCV hose connector that was removed in the last step so you can see the gray buttons on the sides that need to be squeezed to allow removal. Many of the future hoses that need to be removed will have this same release button.



10. Pull out on the red locking mechanism from the MAF sensor connector. Then remove the connector. You can see the locking mechanism in this photo.

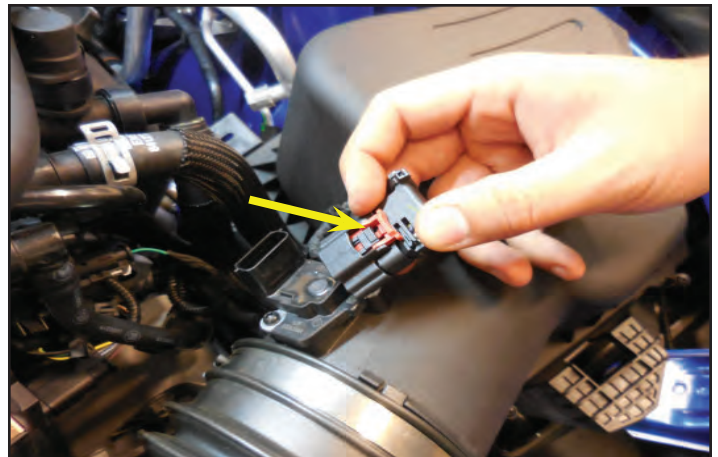

11. Use a paper clip to release the cable tie from the backside to remove the MAF sensor cable. Now you should be able to remove the airbox lid from the vehicle.



12. Remove the intake duct from the throttle body and the air filter box. This will not be reused. Inspect the air filter and replace if necessary.

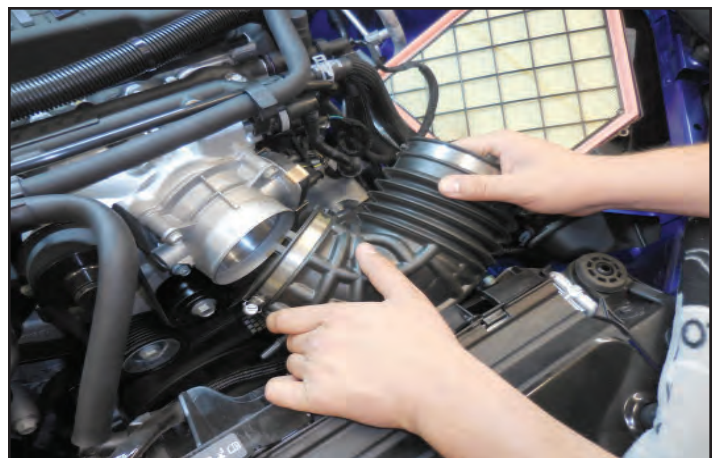

13. Remove the lower part of the airbox by pulling up on it. It has three barbed pins that connect to rubber grommets.



14. Unplug the electronic throttle control connection by first pulling back on the locking tab and then pulling on the connection.



15. Here is a photo of the connection from the last step shown from the underside so you can see the locking tab.

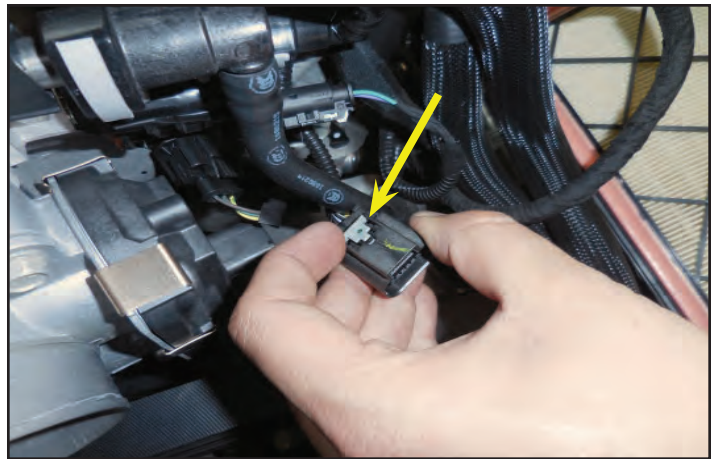

16. Disconnect the brake booster hose connection shown with an arrow. There is a gray release button that must be pressed first prior to removal.



17. Pull up on the connection shown with the hose assembly to release it from the PCV air fitting.



18. Disconnect the hose fitting and electrical connection from the EVAP solenoid. You will have to pull out on the locking tab for the electrical connection before you can release it.



19. Here is a close-up of the electrical connection on the EVAP solenoid with the locking tab.

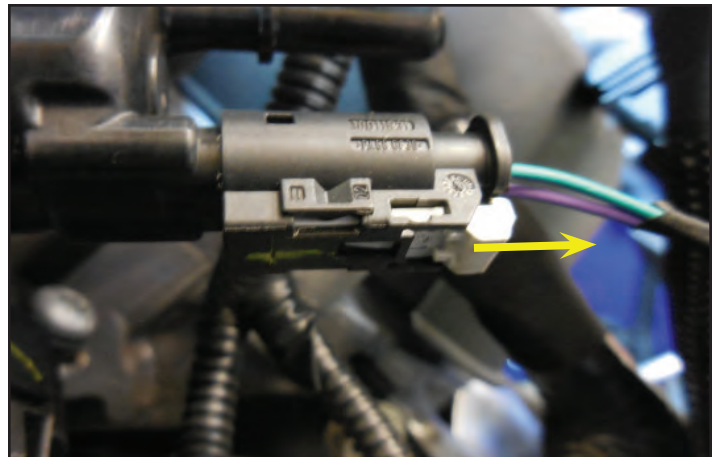

20. Use a 10 mm socket to remove the bolt holding the EVAP solenoid in place. Remove the EVAP solenoid and set it aside for later use.



21. Unplug the MAP sensor by first releasing the locking tab, and then pull it loose.

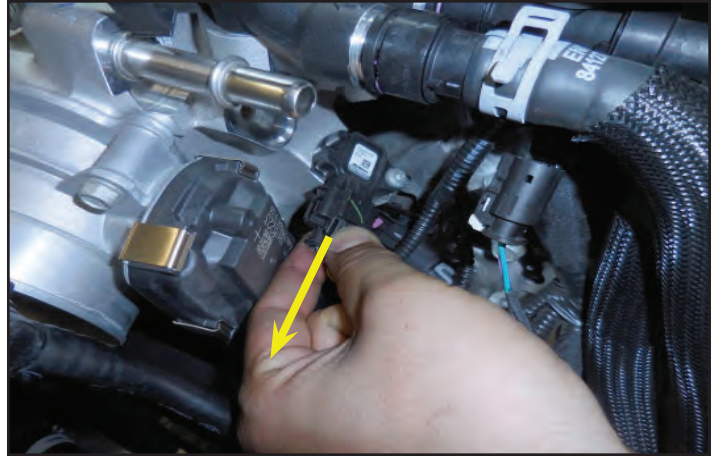

22. Disconnect the EVAP hose shown at the right rear of the OEM supercharger.



23. Disconnect the opposite side of the EVAP hose that was shown in the last photo and remove this hose from the vehicle. It will not be reused.



24. Disconnect the PCV hoses shown with arrows at the right front of the engine.

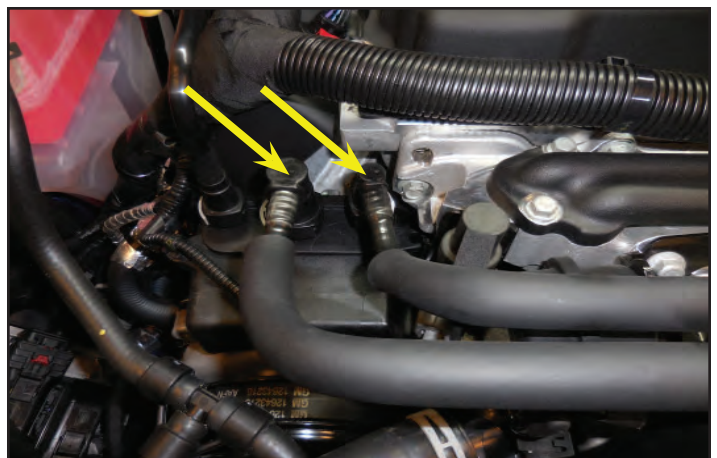

25. Use a screwdriver to release the locking button on the PCV connection shown here on the left coil pack cover.



26. Now you can remove the PCV hose assembly shown. The smaller hose will be replaced with a provided one in a future step. The larger hose will be reused.



27. Remove the two cable tie connections from the front of the supercharger using a pry tool. The second connection is hidden behind the hand in this photo.

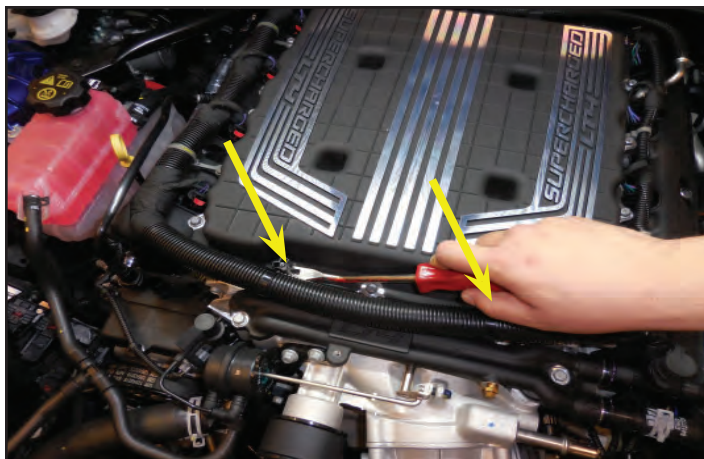

28. Remove the four cable tie connections shown with arrows using a pry tool.



29. Disconnect the 8 coil connections by first pulling back on the red tab, and then unplugging them. You can see one of these connections here shown with an arrow.



30. Remove the supercharger belt by rotating the tensioner shown with the arrow in a counter-clockwise direction using a short 15mm socket and a serpentine belt wrench. This belt will not be reused.



31. Here you can see the serpentine belt wrench attached to the tensioner. Rotate it counterclockwise to release the belt tension and pull the belt off the pulleys. The belt will not be reused.



32. Remove the connection shown with the arrow by first releasing the white tab, and then unplugging the connector.



33. Use a pry bar to remove the cable tie connection shown with the arrow.

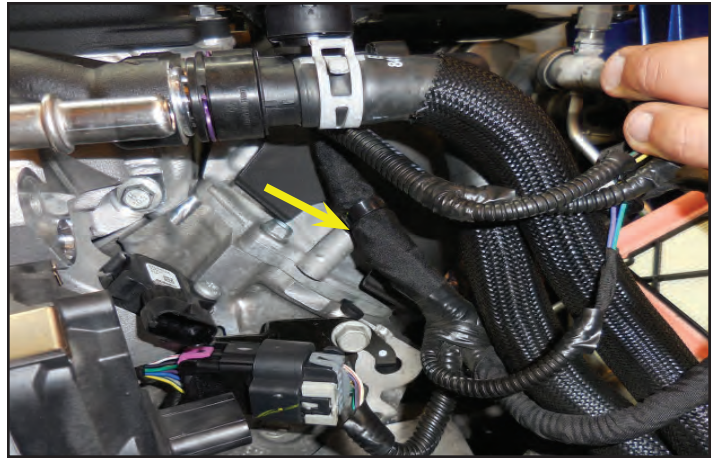

34. Here you can see a pry bar being used to remove the cable tie connection shown in the last step.



35. Place a cup under the intercooler connections as shown to collect the coolant that will be drained in the next few steps.



36. Use a pick or other appropriate tool to remove the two clips that secure the connections for the intercooler hoses.



37. Here is one of the two clips that was removed in the last step. These will not be used again.



38. Once you have removed the clips shown in the last step you can unplug the connection and drain the coolant into the cup. If this coolant is in good shape and kept clean it can be used later to refill the intercooler system.

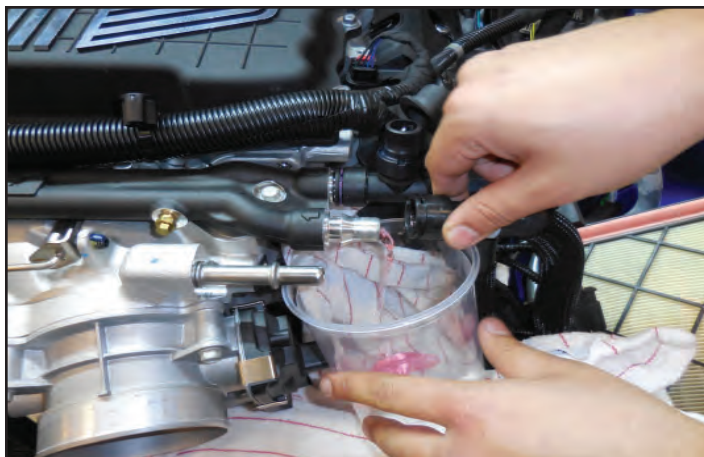

39. Use some small bags and rubber bands or plugs to prevent coolant from spilling out of the hoses you just disconnected.



40. In order to drain more coolant from the supercharger you can install some hoses at the connections you just unplugged. Then place one hose in the drain cup while you pressurize the other hose. This should clear the majority of coolant out of the supercharger.



41. Seal the two connections on the supercharger side as well with plastic bags and rubber bands or plugs. Remove the front MAP sensor shown at the arrow location. This sensor will be installed in a new location in a later step using this OEM fastener.

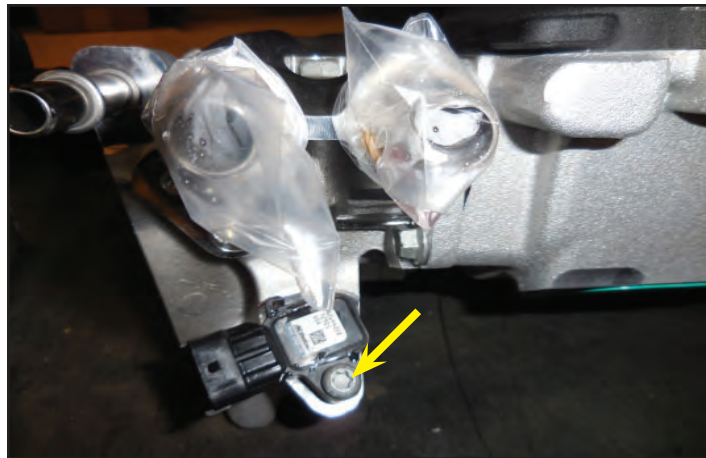

42. Disconnect the plug shown with the green arrow. Also disconnect the two hoses shown with red arrows. Finally remove the bolt holding the bracket in place with a 10mm socket at the blue arrow location. This bypass solenoid, and bracket, will be reinstalled later.

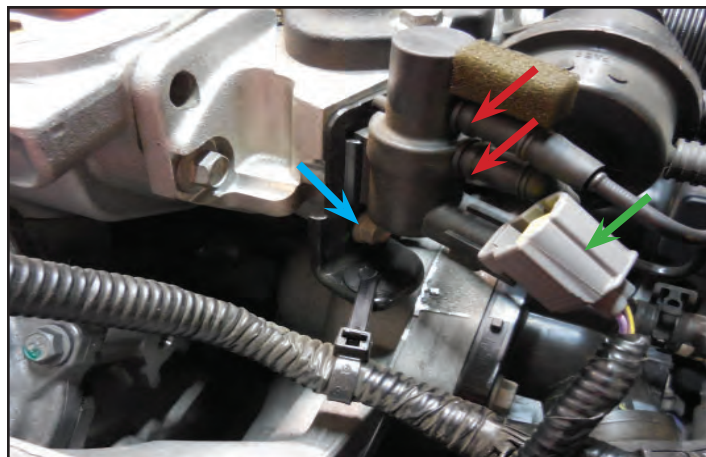

43. Vacuum across the supercharger lid. Remove all debris from the counterbores shown with arrows.

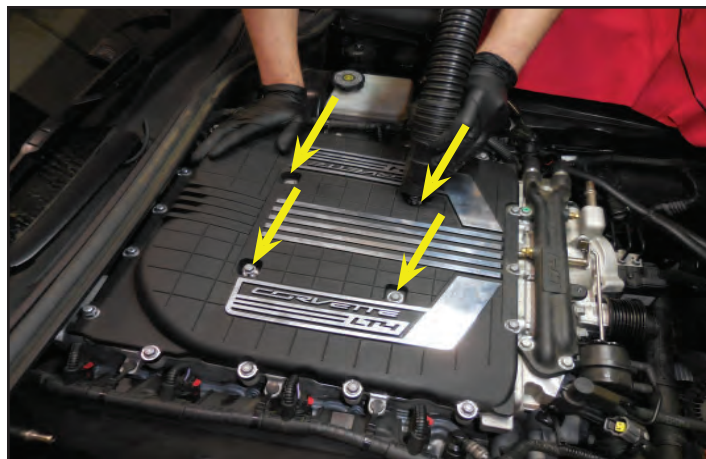

44. Remove all 20 bolts holding the lid in place. Then remove the lid.

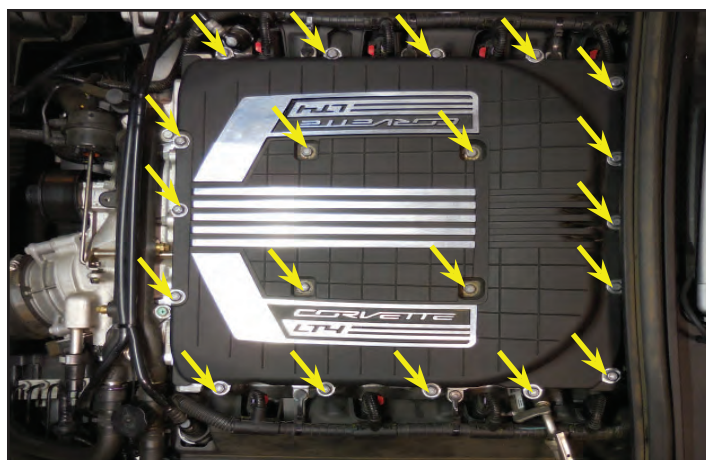

45. Disconnect the MAP sensor at the rear of the supercharger. Pull the red safety clip prior to disconnecting the connector.

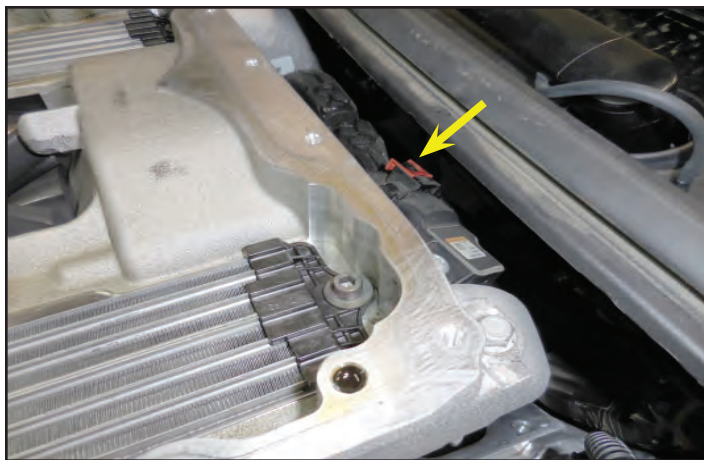

46. Remove the 10 bolts shown with arrows holding the supercharger housing in place. These bolts will not be reused.

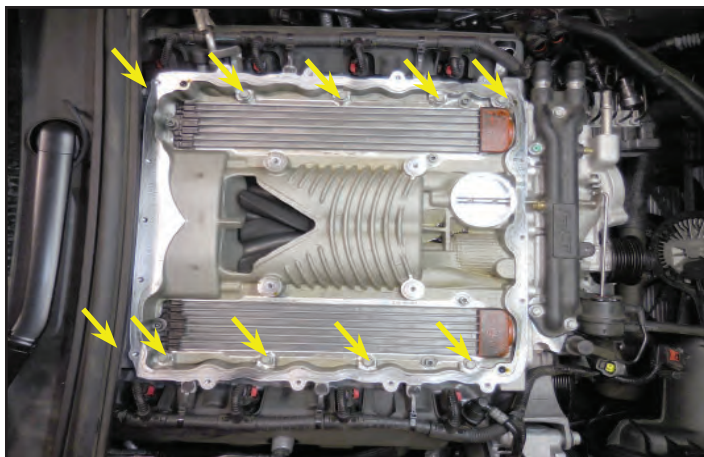

47. Two of the bolts from the last step are hidden below the cowl. This is on the right rear of the supercharger.



48. Here is the other hidden bolt on the left rear of the supercharger.



49. At this point you will need some help to remove the supercharger from the engine. Have at least one other person on the opposite side of the engine bay while you lift it up. Carefully clean up the surface around the intake ports. Use isopropyl alcohol to clean the surface around the ports. **Make sure nothing enters the intake ports.**



50. Clean and inspect the PCV fitting shown with the arrow to ensure it isn't damaged.

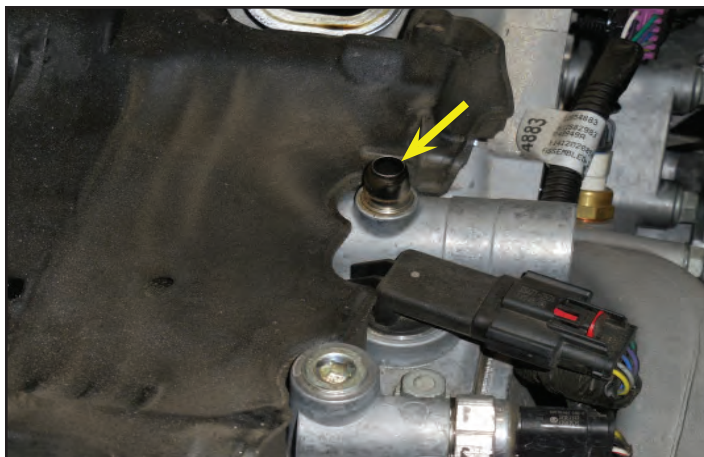

51. Apply blue tape over the ports to prevent anything from entering the engine. Remove the insulation from the manifold valley shown with an arrow. This insulation will not be reused.



52. Vacuum out the manifold valley to remove any debris.

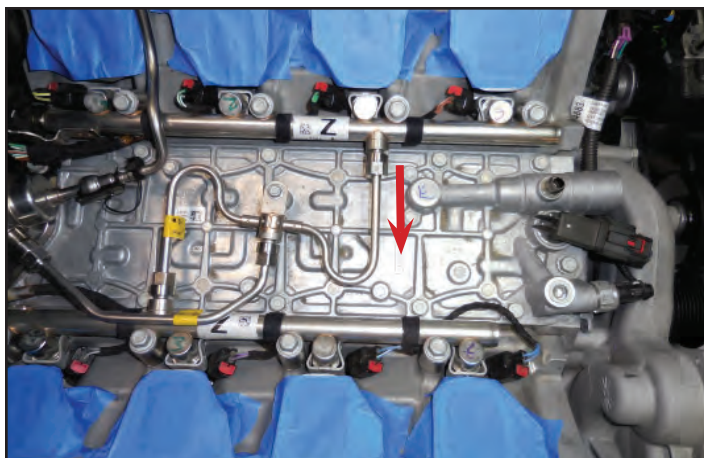

53. **Place shop towels down below the connection shown to catch any residual fuel.** Remove the fuel line safety clip by prying up at the side shown with the red arrow first, and then sliding off in the direction of the green arrow.

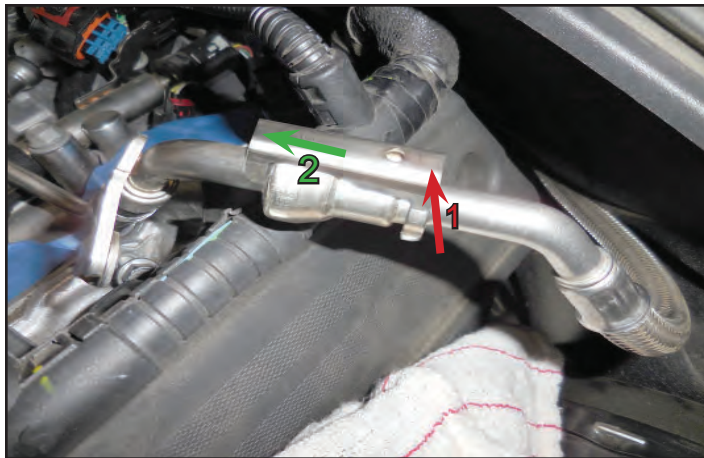

54. **Eye protection is necessary.** Place the provided plastic tool over the fuel line at the green arrow location shown. Push the fuel line in towards the engine. Now pull the plastic tool towards the fuel line. This will disengage the fuel line connection allowing you to pull the line off. This will release the connection. **Be careful while releasing the connection because fuel will spill.** Properly dispose of any fuel soaked rags after the fuel line is removed.



55. Remove the bolt at the green arrow location with a 10mm wrench.

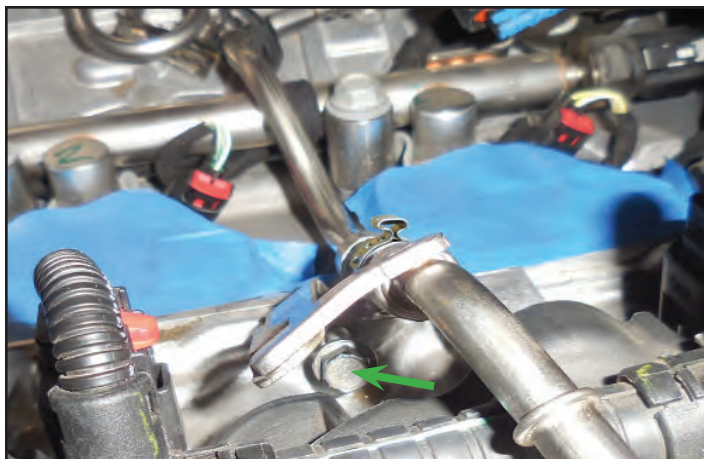

56. Place rags in the manifold valley under the fuel line. Repeat the process of removing the safety clip and disconnect the fuel line using the provided plastic fuel line tool. Remove this fuel line. It will be replaced with a provided fuel line in the next step.

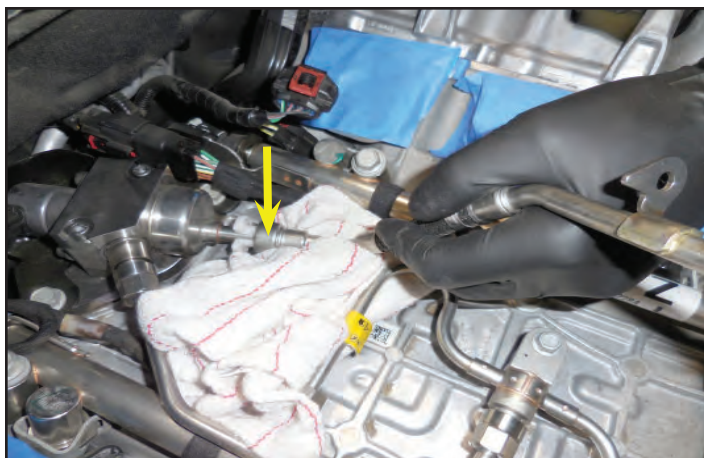

Section 3: Fuel Line Replacement and Valve Cover Modification

57. Gather the provided fuel line.



58. Leave the black plastic release insert on the end of the provided fuel line. This can be used to remove the fuel line in the future if needed.



59. **Lightly lubricate the outer leading edge of the male fuel connector with the provided Lubriplate grease.** Install the provided fuel line by routing it in the location shown highlighted in green. **Ensure that you slide the hose under hardline shown with the red arrow.** The end connections will be shown in the following steps.



60. **Lightly lubricate the outer leading edge of the male fuel connector with the provided Lubriplate grease.** Connect the female fuel line connector at the OEM location in the engine valley. **Ensure that you hear a click which indicates that the connection is secure.** **Pull at the connection to verify it is secure.**



61. **Lightly lubricate the outer leading edge of the male fuel connector with the provided Lubriplate grease.** Connect the male fuel line connector to the female connector on the supply line. **Ensure that you hear a click which indicates that the connection is secure. Pull at the connection to verify it is secure.**



62. Install the OEM clip to the fuel connection from the last step and secure with the OEM plastic tether.

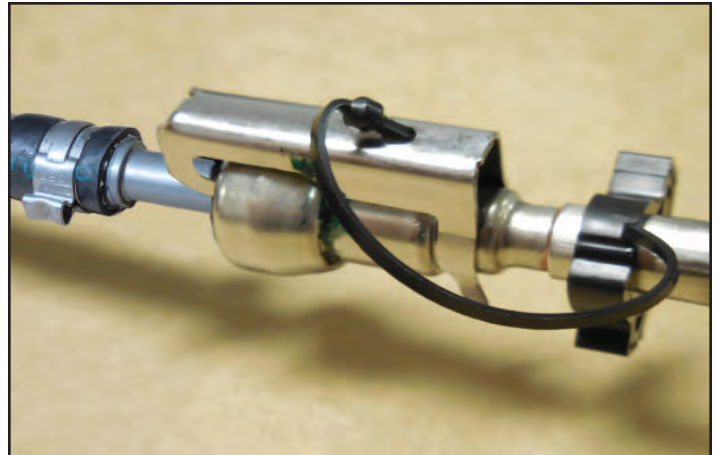

63. Loosen the T30 Torx fasteners (2 each) at the coil covers.



64. Remove the coil cover. Repeat on the opposite side.



65. Disconnect the spark plug wires from all the coils. Disconnect the electrical connector on top of the coils. Remove the two screws securing the coils using a 10 mm socket. Set the coils aside for reinstallation later.



66. Once you have removed all the coil packs you can remove the valve covers. These will be modified in the next steps.



67. Remove the gaskets from the two valve covers.

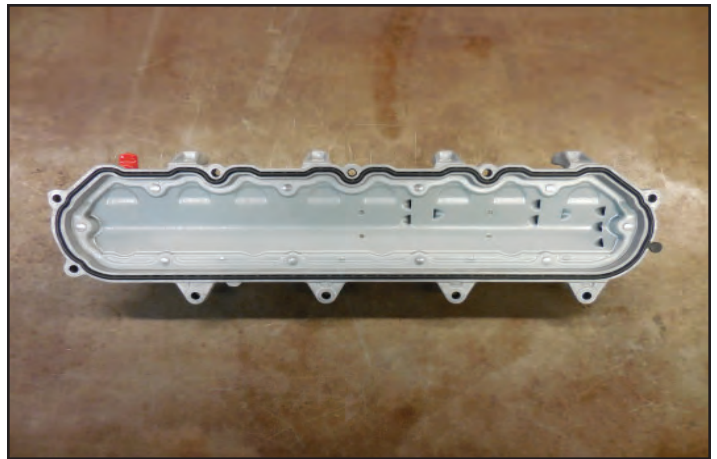

68. There is a tab at the corner that allows you to easily pull this gasket out.



69. Apply masking tape to all the inlets of the valve covers prior to cutting.

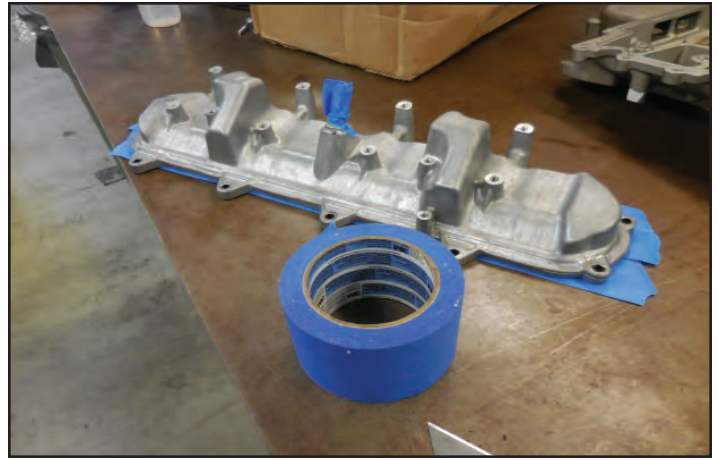

70. Tape the bottom surface as well.

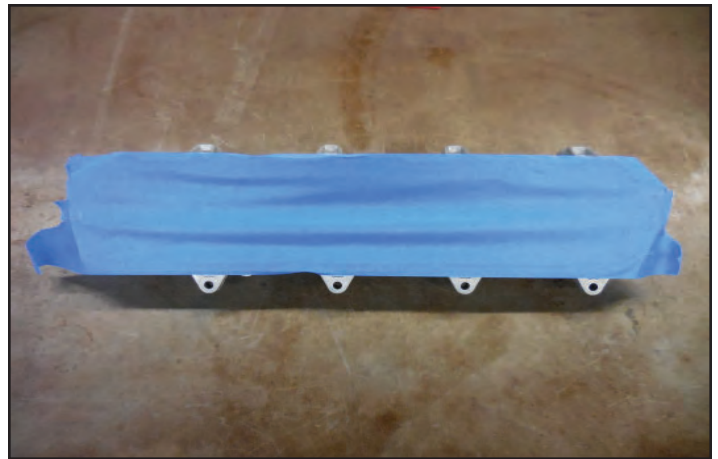

71. Gather the supplied wedges for trimming your valve covers.



72. Place the wedges on the bottom using the bolt holes to secure them in place.

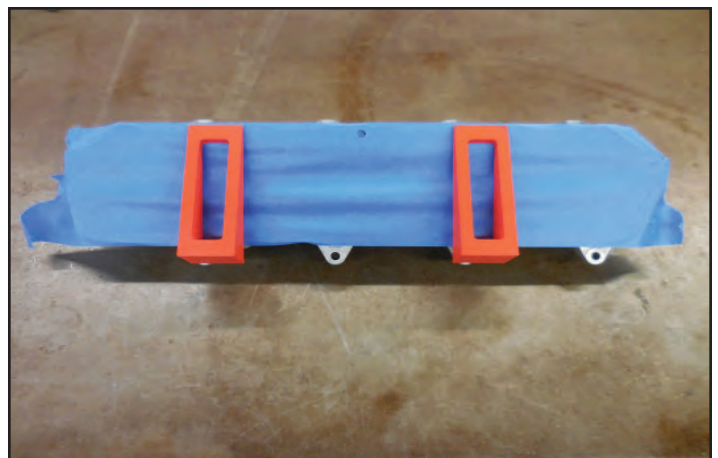

73. Ensure that the wedges sit flat against the bottom of the valve covers, and that they contact the band saw table and guide fence as shown here.

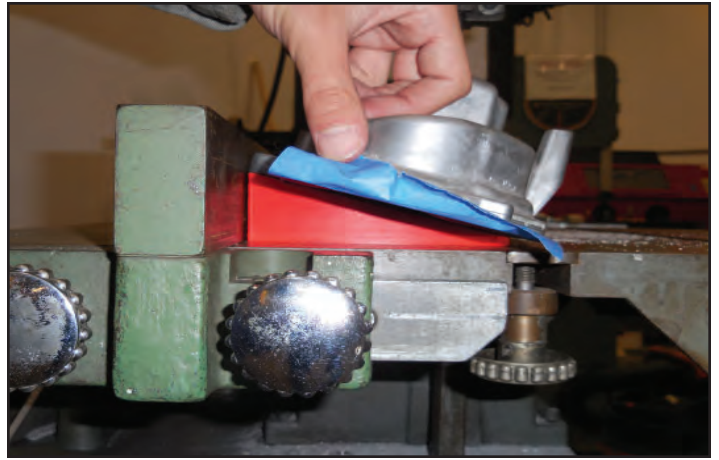

74. Cut each of the top coil pack mounts flush with the valve cover. You will have to stop the saw to reposition the wedges for each cut.



75. Once you have cut the upper coil pack mounts flush you will need to remove any sharp edges. Also thoroughly clean all the debris from the covers once you have removed the sharp edges.



76. Remove the masking tape. **Clean out the debris using a solvent cleaning tank. Ensure that the covers are thoroughly clean and dry before installing them on the heads.** Re-install the gaskets on both valve covers.

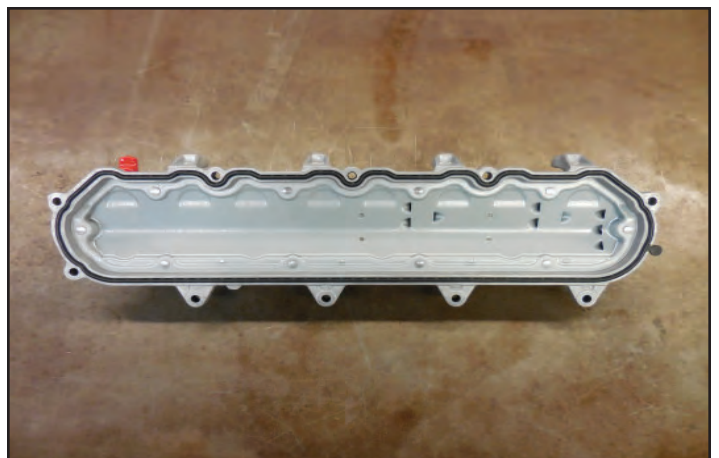

77. Gather the following bracket, nuts and spacers. You will need one set per side.

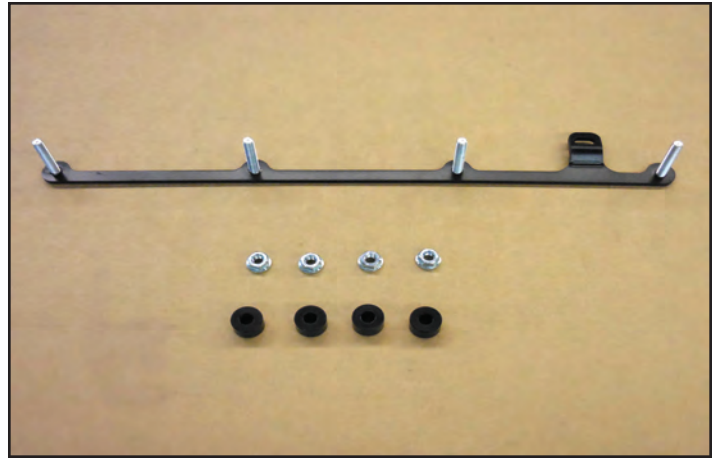

78. Install the spacers on the studs as shown.

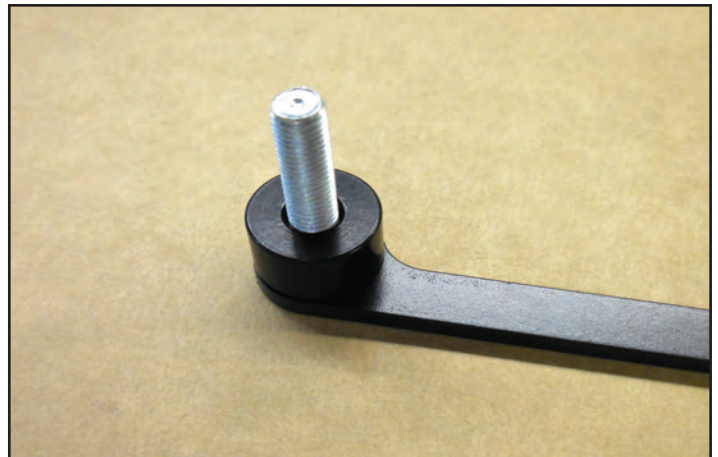

79. Install the coil covers with the supplied lower mount as shown using the provided nuts.

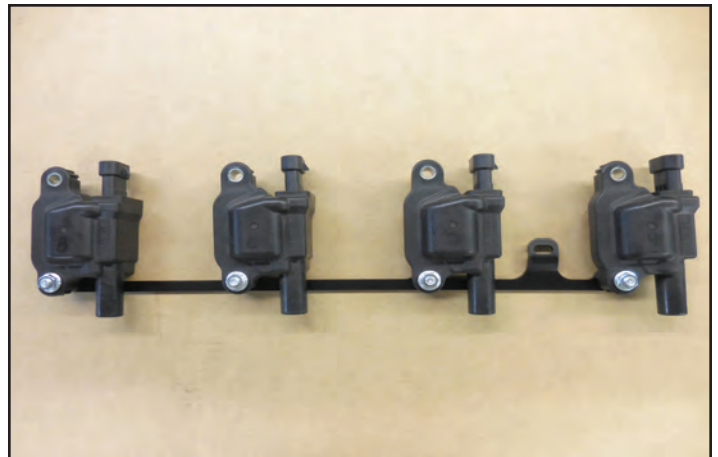

80. Use the OEM bolts at the red arrow locations to install the coils back on the valve covers that were just modified. This will shift the coil packs lower in the engine to give clearance for the supercharger. Install the provided M6x14mm bolt at the yellow arrow location. Repeat this process on the other valve cover.

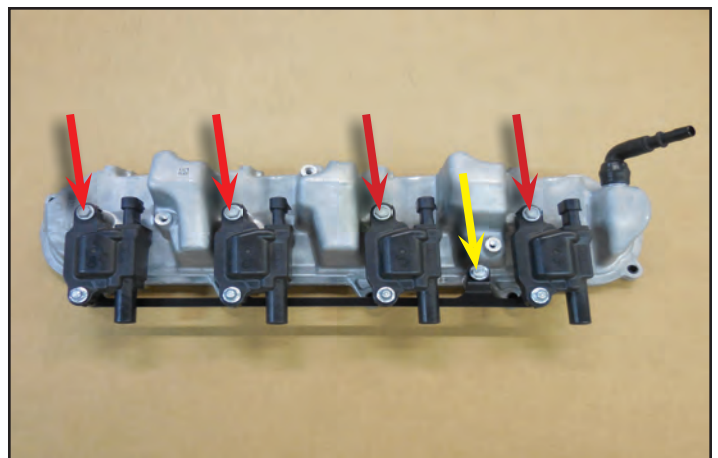

81. Reinstall the valve covers and carefully route the wires out of the way as shown here.



82. Use a provided Adel clamp to secure the fuel line at the arrow location.



Section 4: **Preparing the Supercharger for Installation**

83. Remove the MAP sensor from the back of the OEM supercharger.



84. Remove the bolt from the location shown here on the new supercharger. This is where the MAP sensor from the previous step will be installed. Apply a light coat of supplied Lubriplate grease to the bore shown with an arrow.

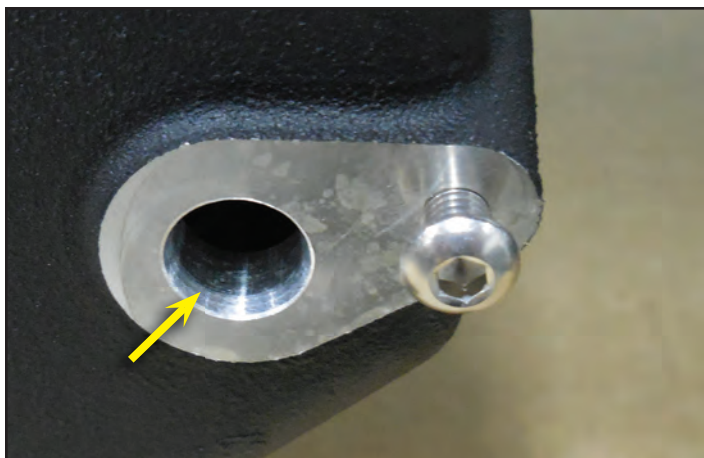

85. **Apply Loctite 242** to the end of the bolt removed in the last step.



86. Apply a light coat of Lubriplate grease to the O-ring on the MAP sensor and carefully press it into place. Install the bolt from the last step and tighten in place.



87. Apply some supplied Lubriplate grease to the PCV seal at the bottom of the Magnuson supercharger.

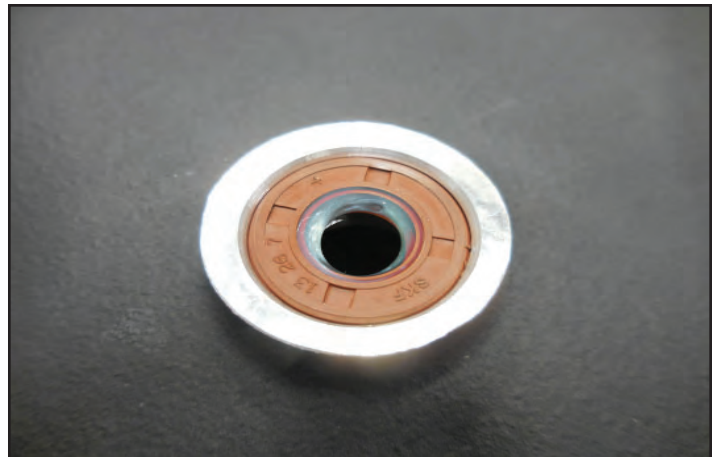

88. Remove the 19 M6x30mm bolts around the perimeter of the lid and remove the lid. Also remove the four screws holding the Magnuson Supercharger Emblems to gain access to the 4 bolt locations that will be fitted with M6x30mm bolts later.



89. Remove the 3 bolts holding the coolant manifold assembly at the front of the supercharger and pull the spigot out. Repeat this process on the other coolant manifold assembly.

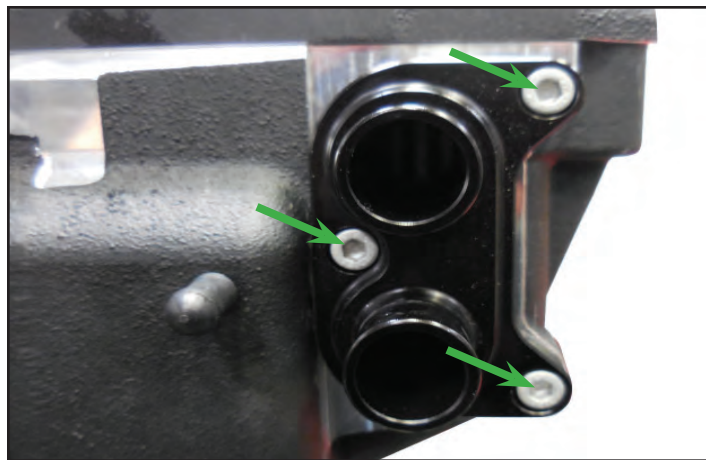

90. Remove the 6 bolts holding the charge air coolers inside the supercharger housing and pull the charge air coolers out. Carefully pull out the charge air coolers by hand. Pull evenly around the perimeter to disengage the seal.



91. Gather the MAP/IAT breakout harness.



92. Pre-install the IAT sensor wire to the supercharger prior to installation. Be careful with the wire assembly while you are installing the supercharger.

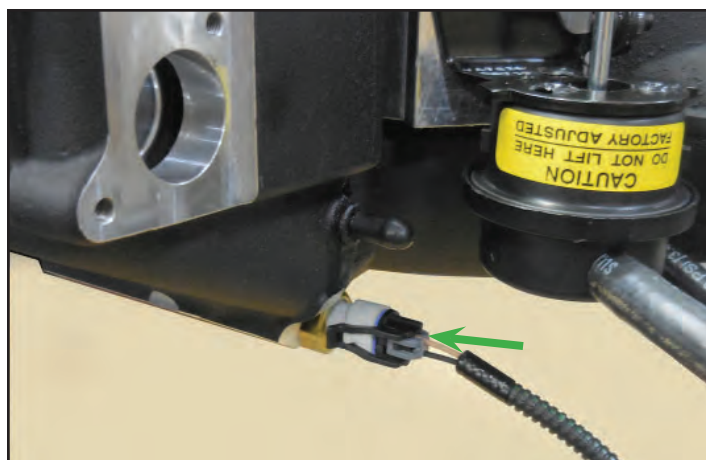

93. Remove the blue tape from the intake ports.

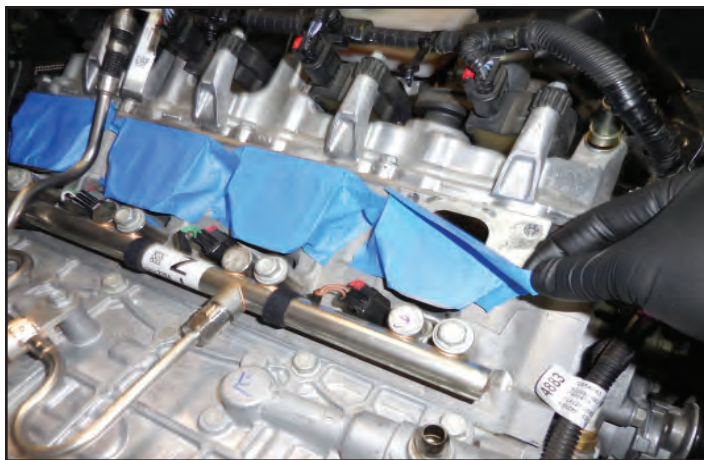

94. Wipe down the intake port outer sealing surfaces with a rag coated with Tri-flow. Pull the coil harnesses to the sides to make clearance for supercharger installation. Ensure that there are no tools or other items left in the valley area before you install the supercharger.



95. Have someone help you support the supercharger from the opposite side while installing. Carefully place the supercharger on the inlets for the heads. Leave enough space at the back to allow the installation of the rear MAP sensor connection.

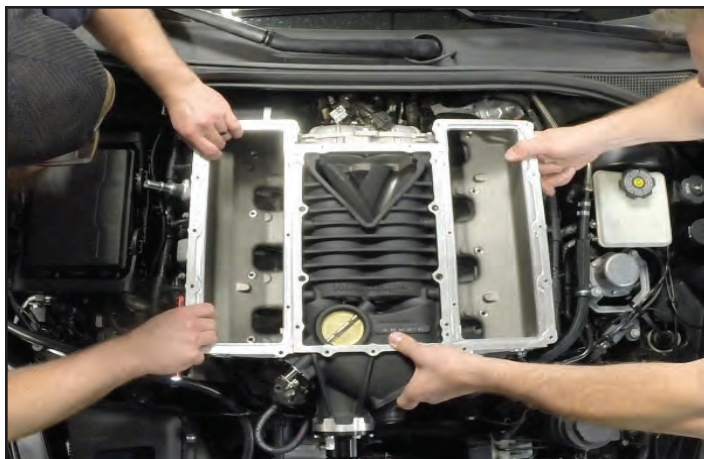

96. Plug in the MAP/IAT breakout wire assembly into the rear MAP sensor shown here at the arrow location.



97. Plug in the other end of the MAP/IAT breakout wire assembly to the wire that led to the OEM rear MAP sensor. After you have plugged in the MAP sensor you can slide the supercharger assembly back so the intake ports line up.



98. Install the provided seal washers shown with a blue arrow on 10 provided M6x30mm flange bolts. Once you have slid the washers on all the way to the heads apply a light coat of Lubriplate grease to their undersides. Finally **apply blue Loctite 242** to the ends of these bolts as shown.



99. **Ensure that the supercharger is sitting flush with the intake ports prior to installing the bolts.** Install the bolts from the last step into the locations listed on the diagram at the back of this book. First finger tighten all bolts. Gradually work your way up to the torque specification listed while you follow the numerical order listed in the diagram. **Make 3 passes, slightly increasing tightening each time. Then make a final pass at 106 in-lbs following the torque sequence at the back of this book.**



100. **Ensure that the supercharger pulley still spins freely after full torque is applied.**



101. Locate the six M5x12mm button head bolts that held the charge air coolers in place. **Apply the provided Loctite 242** on the ends of each bolt.



102. Reinstall the charge air coolers (2 each). Ensure that the port holes match with holes in the housing. Secure with the six M5x12mm button head bolts from the last step in the locations where they were originally.



103. Gather the coolant manifolds shown that were removed earlier. **Relube all the O-rings with the provided Lubriplate grease prior to reinstalling the coolant manifolds.**



104. **Apply Loctite 242** to the six M5x16mm socket head bolts coolant manifold bolts that were removed earlier.



105. Carefully install the coolant manifolds, taking care not to damage the O-rings, with the six M5x16mm socket head bolts from the last step. After you have tightened these six bolts go back and tighten the 6 bolts holding the charge air coolers.

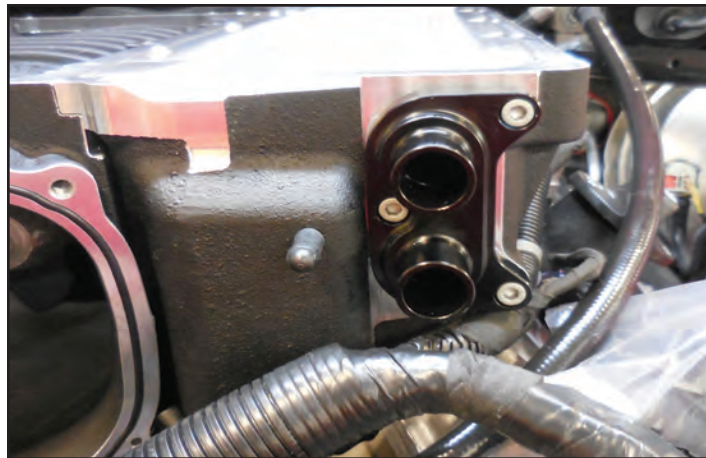

106. **Apply Loctite 242** to the 19 M6x20mm bolts that were removed from the lid and 4 more M6x30mm bolts that were provided and re-install the lid. The four M6x30mm bolts are for the center locations on the lid.



107. Lightly re-install the lid using the bolts from the last step. Leave the one in the right rear out for now.



108. Gather the following provided 38" hose with mesh over it, shrink tube, 17mm Oetiker clamp, and fittings. Follow the instructions in the next step for assembly of this EVAP hose.



109. Ensure that the 90° fitting has the white release button. After this you will slide the heat shrink tubing half way over each end of the mesh and the other half over the hose to protect the mesh from fraying. Use a heat gun to shrink the tubing over the ends of the mesh. Slide the 17mm Oetiker clamp over the side where you will put the straight connector. Press the barbed ends of the straight and 90° fitting into the ends of the hose until they bottom out. You may need to heat the hose a little to get the 90° fitting on. Use Oetiker clamp pliers to secure the clamp.



110. Connect the straight fitting from the last step to the hardline at the back of the supercharger. Secure the end by closing the red plastic clamp.



111. Place the provided M6 washer at the corner location of the supercharger lid.



112. Install a provided Adel clamp at the corner lid location and secure with an M6x30mm bolt.



113. Zero torque the fasteners first before applying the final torque. **Torque these 23 bolts to 106in-lbs following the order for the lid given at the back of this manual.**



114. Gather the provided Magnuson Supercharged badges and M4x8mm bolts. Application of the adhesive backing from the two provided Magnuson Supercharged badges is optional.



115. Be aware that these badges will be difficult to remove once the adhesive has been applied. Install the badges using the provided bolts.



116. Continue routing the EVAP hose from four steps ago in the direction shown highlighted here. The 90° fitting will go under the inlet of the supercharger (shown with an arrow) and will be connected to the EVAP solenoid in a future step.



117. Here is a front view of the EVAP hose that was shown in the last step. Again the 90° fitting will be connected later.

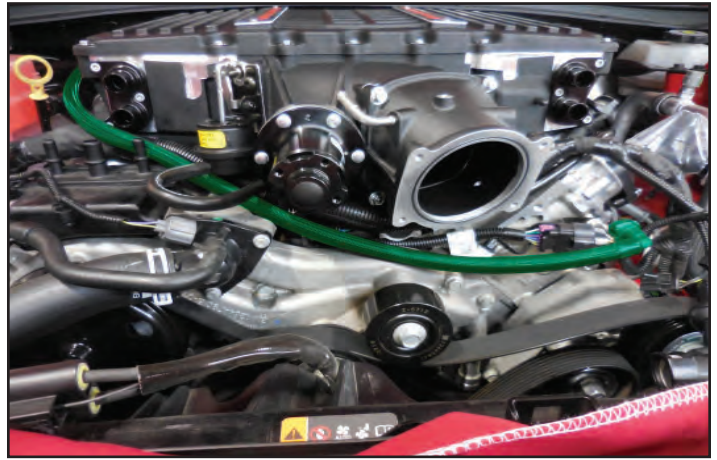

118. **Apply Loctite 242** to the provided three M6x25mm bolts and both sides of the provided stud.



119. Prior to installing the throttle body adaptor make sure that the O-ring is installed in the supercharger housing and throttle body adaptor. Install the stud and nut from the last step at the green arrow location. Ensure that the stud is protruding enough for the nut to have full thread engagement. Install the three M6x25mm bolts from the last step to the throttle body adaptor in the red arrow locations shown (the dashed arrows show bolt locations that are hidden from view) and **torque to 106in-lbs.**

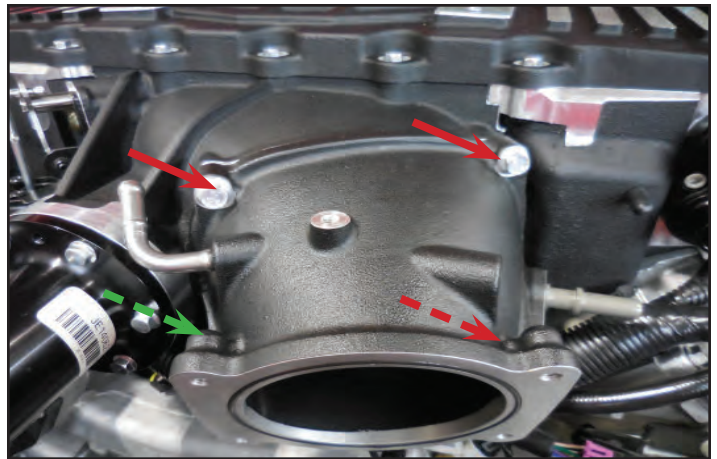

120. Here you can see the stud location for the inlet adaptor with the stud protruding enough for full thread engagement.



121. Remove the plastic anchor holding the electrical connection shown at the yellow arrow. Remove the bolt from the location shown at the red arrow but do not remove the bracket it is holding. This bolt will be replaced with a supplied one. This bracket will be secured with the new assembly in the next step.

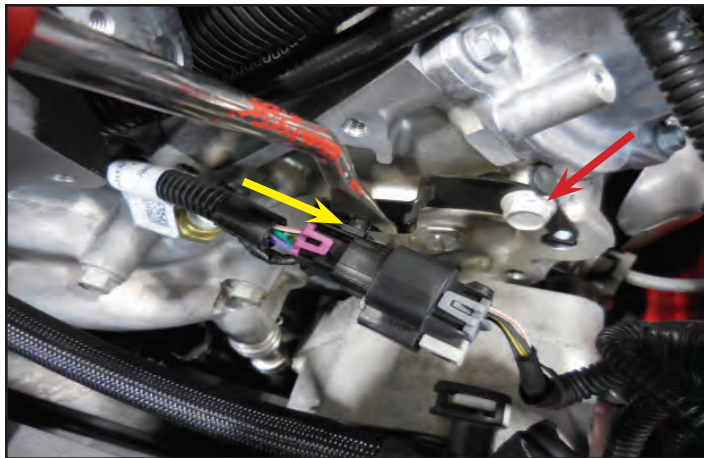

122. Gather the following supplied front MAP sensor bracket assembly and 5/16" diameter hose. Press the 20"x5/16" hose on the brass barb. This assembly will allow you to reroute the front MAP sensor into a new location. Remove the MAP sensor from the front of the OEM supercharger and install it to the adaptor using the OEM bolt in the location shown with an arrow.



123. Install the supplied M8x45mm bolt and spacer shown to the front MAP sensor mounting bracket assembly from the last step.



124. Install the MAP sensor bracket assembly at the bolt location that was removed earlier using the supplied M8x45mm bolt and spacer from the last step. Route the hose under the inlet as shown here highlighted in green. Reattach the anchor for the electrical connection to the bracket that was removed earlier using a supplied cable tie.



125. Install the provided cable tie with the “tree” mount on it (shown with the yellow arrow) to the electrical connection from the last step and install the “tree” into the threaded hole shown with the red arrow. Also at this time reconnect the wiring plug to this connection.



126. Install the opposite end of the hose from the last step to the air tube shown with the arrow. This hose will wrap around the supercharger inlet. Ensure that the hose does not interfere with the belt line.

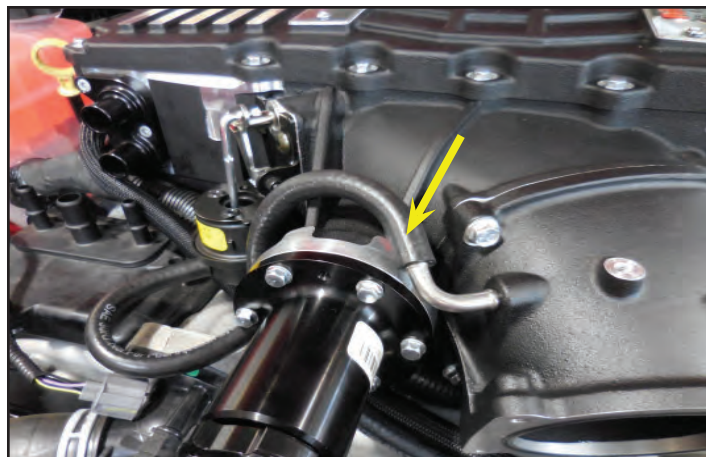

127. Unplug the other end of the brake booster hose assembly shown here highlighted in green at the arrow location. You can see a better image of this hose assembly in the next step. This hose will be replaced with the one shown in the next step.



128. The brake booster hose assembly shown at the top was removed in the last step. Gather the provided brake booster hose assembly shown at the bottom of this photo.



129. Install the provided brake booster hose assembly in the location shown. This hose has been highlighted in green for clarity.

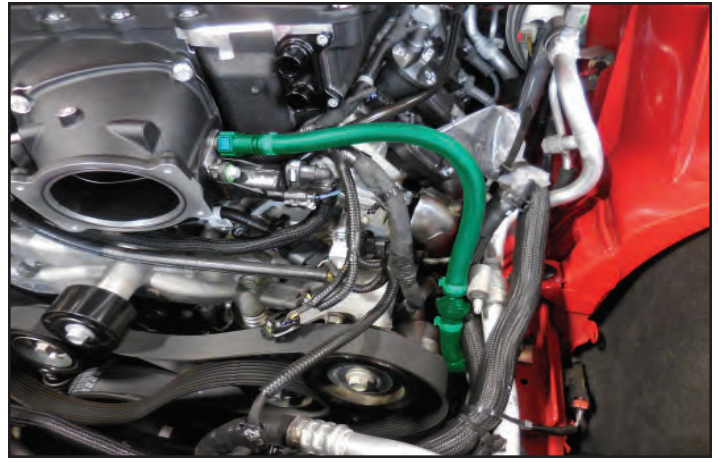

130. Place the EVAP solenoid in the location shown with the yellow arrow. Use the original bolt to secure the EVAP solenoid, and **torque it in place to 108 in-lbs.** Reinstall the EVAP hose (highlighted in green) and the electrical connection to the EVAP solenoid. Press in on the locating tab once the electrical plug is in place. Ensure that the electrical connection is secure.



131. Install the throttle body using the OEM bolts and **torque them to 108 in-lbs.** Install the pulley with the provided M6x16mm bolts and **torque them to 108 in-lbs.**



132. Plug in the electronic throttle control and ensure that the lock is engaged.

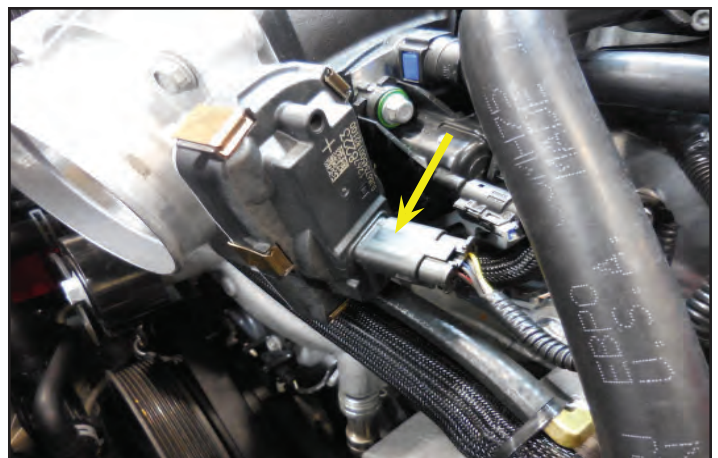

Section 5: Coolant Line and Air Duct Installation

133. Cut the 4"x36" 90° hose to 3.5"x22" measuring from the outside edges of the hose as shown in the photo. Slide the provided 19" mesh onto the 22" length highlighted here in green. Cut the 4"x18" 90° hose to 3.5"x6.5" again measuring from the outside edge. Also gather the "Y" connector, shrink clamps, spring clamps, and worm gear clamp shown. These will be connected to the charge air cooler ports in the next step. Save the hose that was cut from the 4"x36" hose for connecting to the reservoir later.

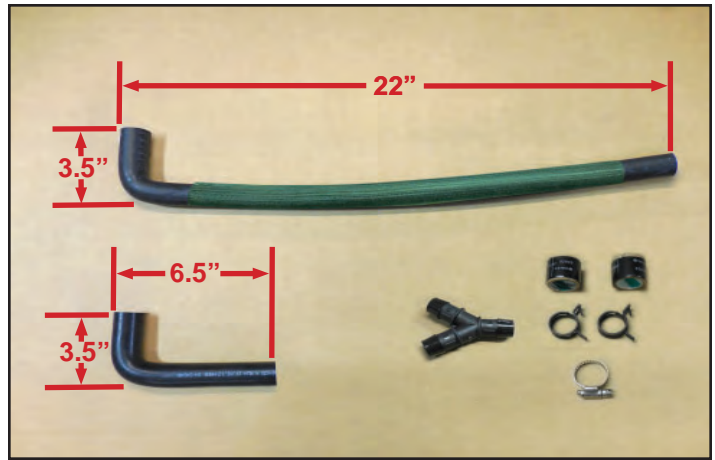

134. Route the hoses from the last step into the green highlighted areas shown here. Secure them at the yellow arrow locations with the two provided spring clamps shown in the last photo. Use the "Y" connector to join them at the blue arrow location, and secure them with the two provided shrink clamps from the previous step as directed in the next step.

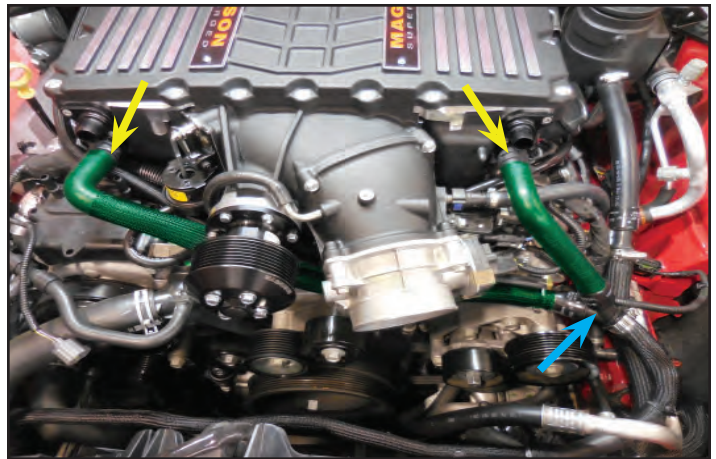

135. Here is a close-up of the "Y" connection from the last step. You will need a heat gun to shrink the two clamps shown with blue arrows. Move the heat gun around the connector to ensure even heating. Be careful not to melt anything around this connection. Ensure that the connections are tight by pulling on them once you have shrunk the clamps. Secure the 22" hose section with a provided cable tie to the brass connector on the front MAP sensor bracket highlighted in green and shown with a yellow arrow.

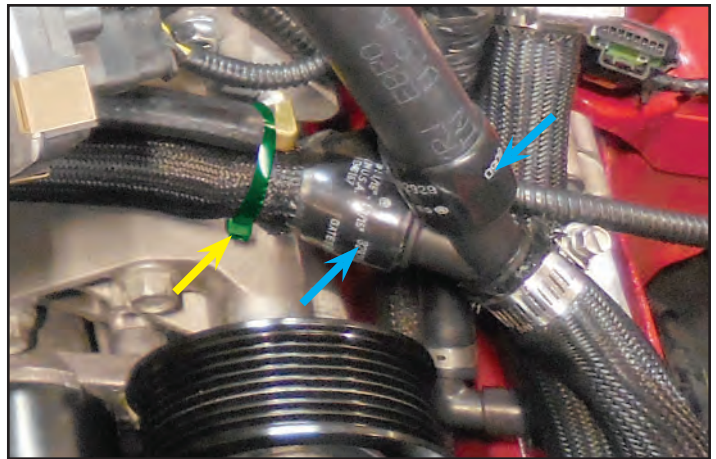

136. Cut the hose going to the OEM intercooler radiator (highlighted in green) to fit at the "Y" connector. Secure it with the provided worm gear clamp shown at the yellow arrow location.



137. Gather the provided upper charge air cooler hose assembly.

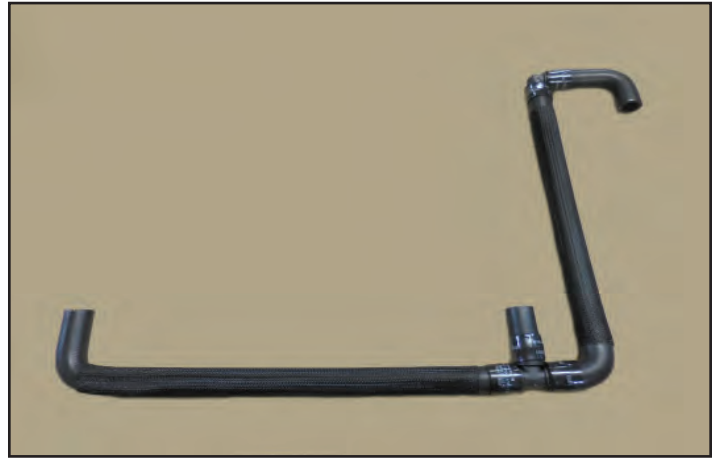

138. Install the upper charge air cooler hose assembly to the upper coolant manifold spigots at the yellow arrow locations with two provided spring clamps.



139. Gather the provided reservoir and install it to the provided bracket using the 3 bolts that came attached to the reservoir.



140. Remove the two bolts shown at the green arrow locations and use this location to install the reservoir bracket from the last step. **Torque these two bolts to 18 ft-lbs.** Install the opposite end of the hose assembly from two steps ago at the back of the reservoir (shown with a yellow arrow) and use a provided worm gear clamp to secure the location.



141. Cut a 9" hose section from the material that was left over after cutting the 4"x36" 90° hose. This will be used to connect the reservoir output to the OEM intercooler pump inlet along with the 3/4" hose mender, shrink clamp, and two worm gear clamps. These items will be used in the next step. Connect one end of the 9" hose to the 3/4" hose mender and secure with the shrink clamp. Again make sure the connection is tight after heating the clamp by pulling on it.



142. Connect the 9" hose that was connected to the hose mender to the output of the reservoir using a worm gear clamp at the yellow arrow location. Connect the hose mender side to the input hose for the intercooler pump at the green arrow location and secure with a worm gear clamp. You will have to cut the OEM intercooler pump hose to fit.



143. Use a belt tensioning wrench, or other suitable socket and wrench to provide slack in the belt to install it according to the routing diagram given at the back of this manual. Rotate the supercharger tensioner counter-clockwise to provide slack at the yellow arrow location. It is easiest to install the last portion of the belt at the smooth idler shown with the blue arrow.



144. After you have inspected the air filter to ensure it is clean reinstall the airbox making sure that all 5 screws are fastened and the rubber grommets are engaged.



145. Plug in the MAF connector at the airbox lid.



146. Secure the intercooler lines at the green highlighted location shown with an arrow with a provided cable tie. Do not crush the hose.

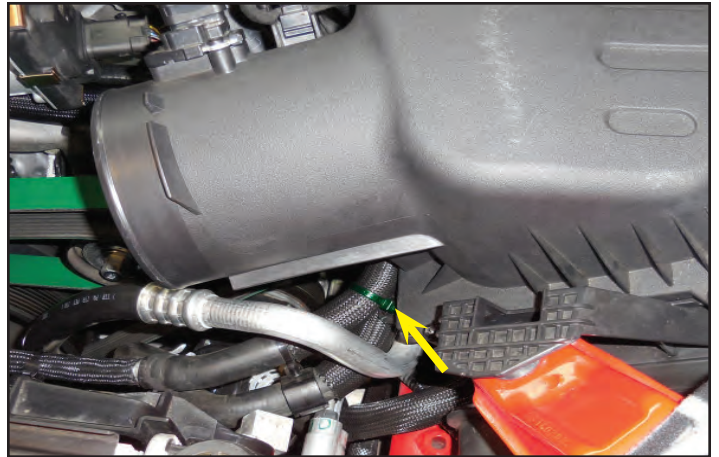

147. Secure the intercooler lines at the green highlighted location shown with an arrow with a provided cable tie. Do not crush the hose.



148. Install the provided rubber air duct. Use the two provided hose clamps to tighten the air duct in place. Ensure that the duct lines up with the notches in the air box and the throttle body shown with the blue arrows.

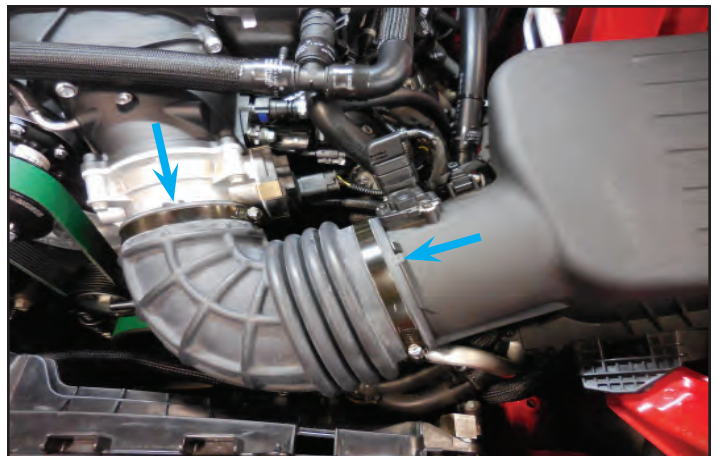

149. Connect the right side OEM vent hose shown at the two arrow locations.

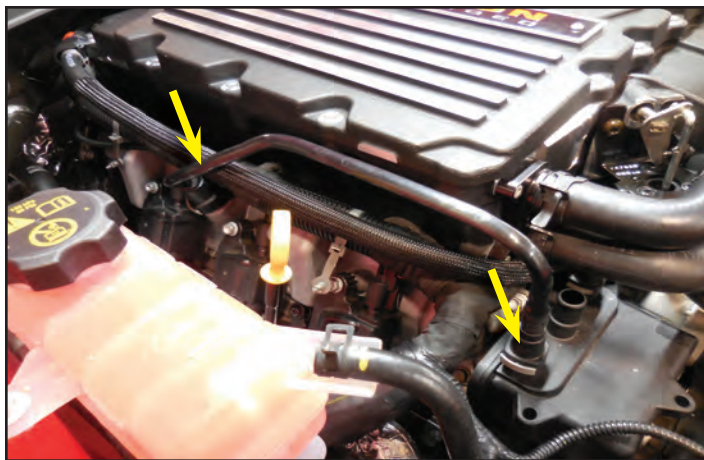

150. Re-connect the OEM vent hose at the left valve cover.



151. Connect the opposite end of the hose from the last step at the original arrow location.

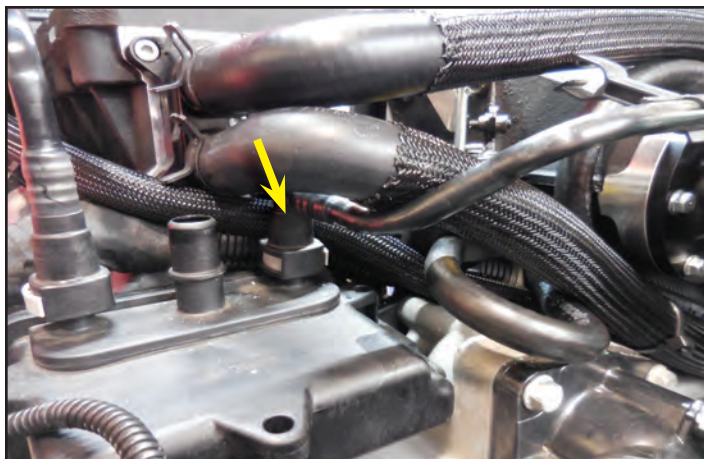

152. Here is the routing of the hose from the last two steps highlighted in green.



153. Install the provided vent hose to the arrow locations.

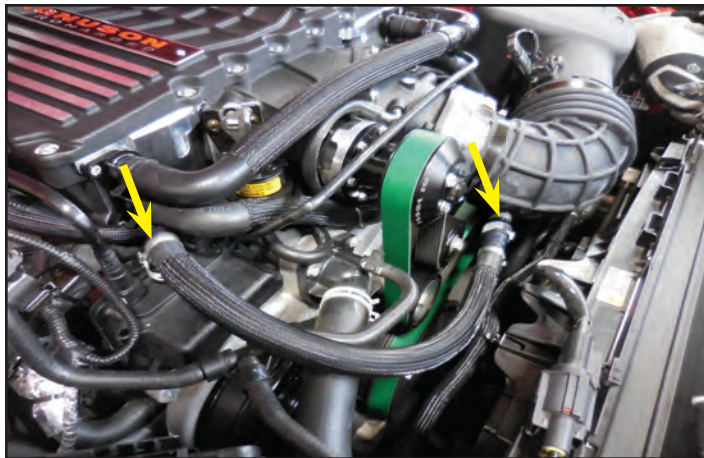

154. Remove the bypass solenoid from the OEM supercharger. Install the two provided rubber caps shown with arrows.

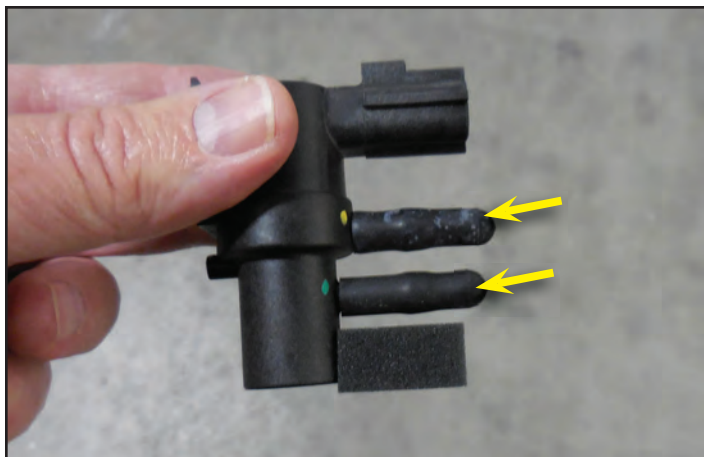

155. Install the bypass solenoid back into its original bracket and secure it to the location shown with the arrow with a provided cable tie. Plug the OEM electrical connection back into the bypass solenoid.



156. Connect the negative terminal of the battery and tighten the nut with a 10 mm wrench.



Make sure that you have followed step #1 in this manual to load the proper supercharger calibration to your vehicle's ECM.



Section 6: Coolant Fill and Final Testing

*****WARNING: You must perform a vacuum leak down test on your intercooler system prior to adding any coolant. This can be accomplished with the same equipment that is used for engine cooling systems.*****

157. Place rags around the intercooler reservoir. Use the GM approved engine coolant mixture to fill your intercooler reservoir to capacity. You can temporarily leave the cap off the reservoir to monitor coolant level. Clear tools and other items from engine area.

158. Have an assistant start the engine and let it idle for a few seconds to get the intercooler pump to start. Check for belt alignment at this time. Before the reservoir drains completely have your assistant turn the engine off. Do not let the reservoir run dry. Fill the reservoir some more and have your assistant cycle the engine again until you see the coolant level remain constant. While the pump is running check for circulation in the reservoir, and coolant leaks. Fill the reservoir to the base of the neck of the housing once all the air has been removed.

159. The supercharger is shown fully installed. Start the engine and check for coolant, and fuel leaks. Test drive the vehicle for the first few miles under normal driving conditions. **Do not attempt any wide open throttle runs.** Check for any unusual sounds, vibrations, or engine misfires. The supercharger does have a slight whining noise under boost conditions, which is normal. After the initial test let the engine cool down, and recheck coolant levels.

160. After the initial test drive gradually work the vehicle to wide open throttle runs. Listen for any engine detonation (pinging). If engine detonation is detected let up on the throttle immediately. Most detonation is caused by low octane gasoline still in the tank. **Premium 91 octane fuel is required.** Affix the "Premium Fuel Only" sticker to the door of your gas fill cap. **After you finish your installation and road test your vehicle, please fill out the warranty registration. This can be found on our website**



161. Clean the surface in the location shown with the green circle and apply the provided CARB label.



Appendix

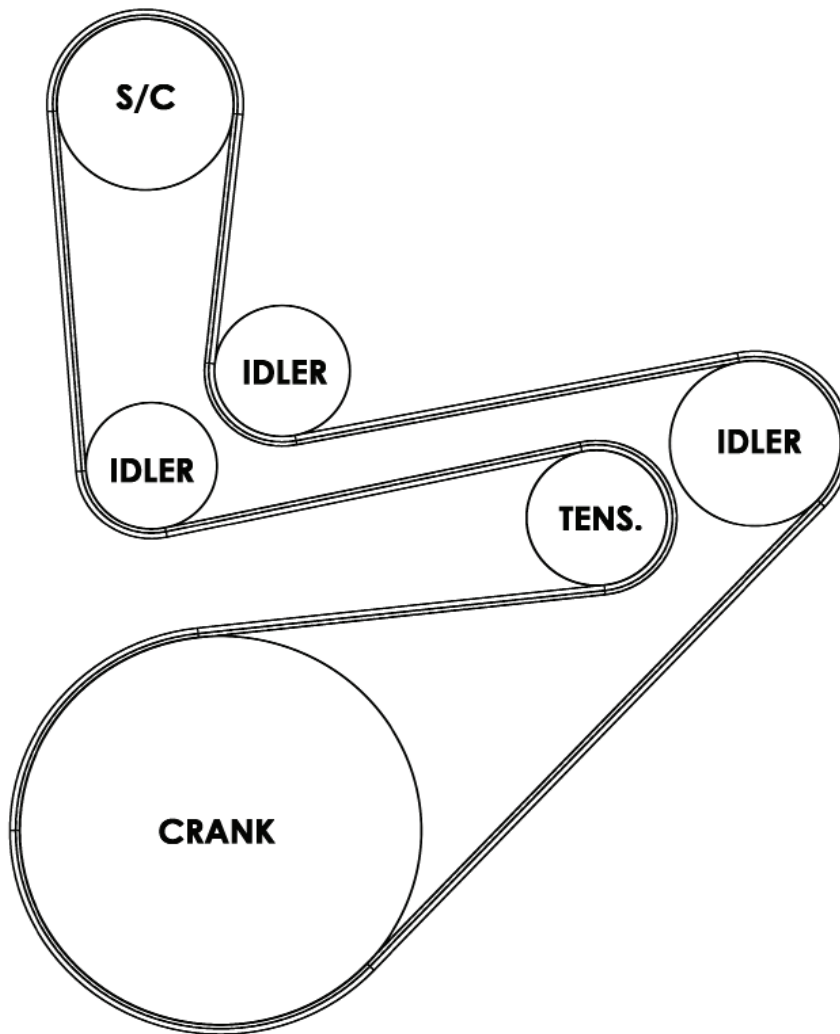

Supercharger Belt Diagram

Torque Specifications

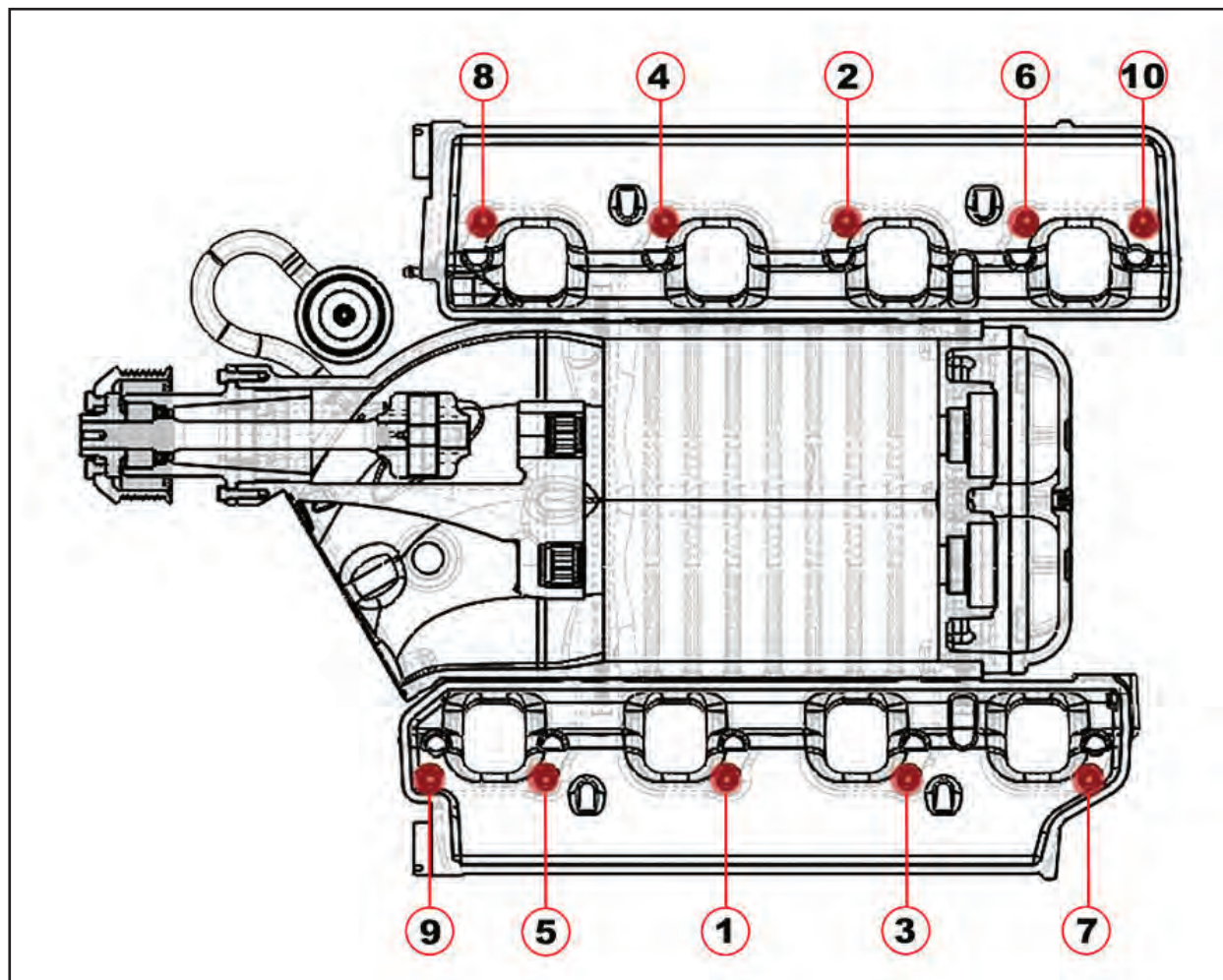

Supercharger to Cylinder Heads: 106in-lbs

Torque Specifications

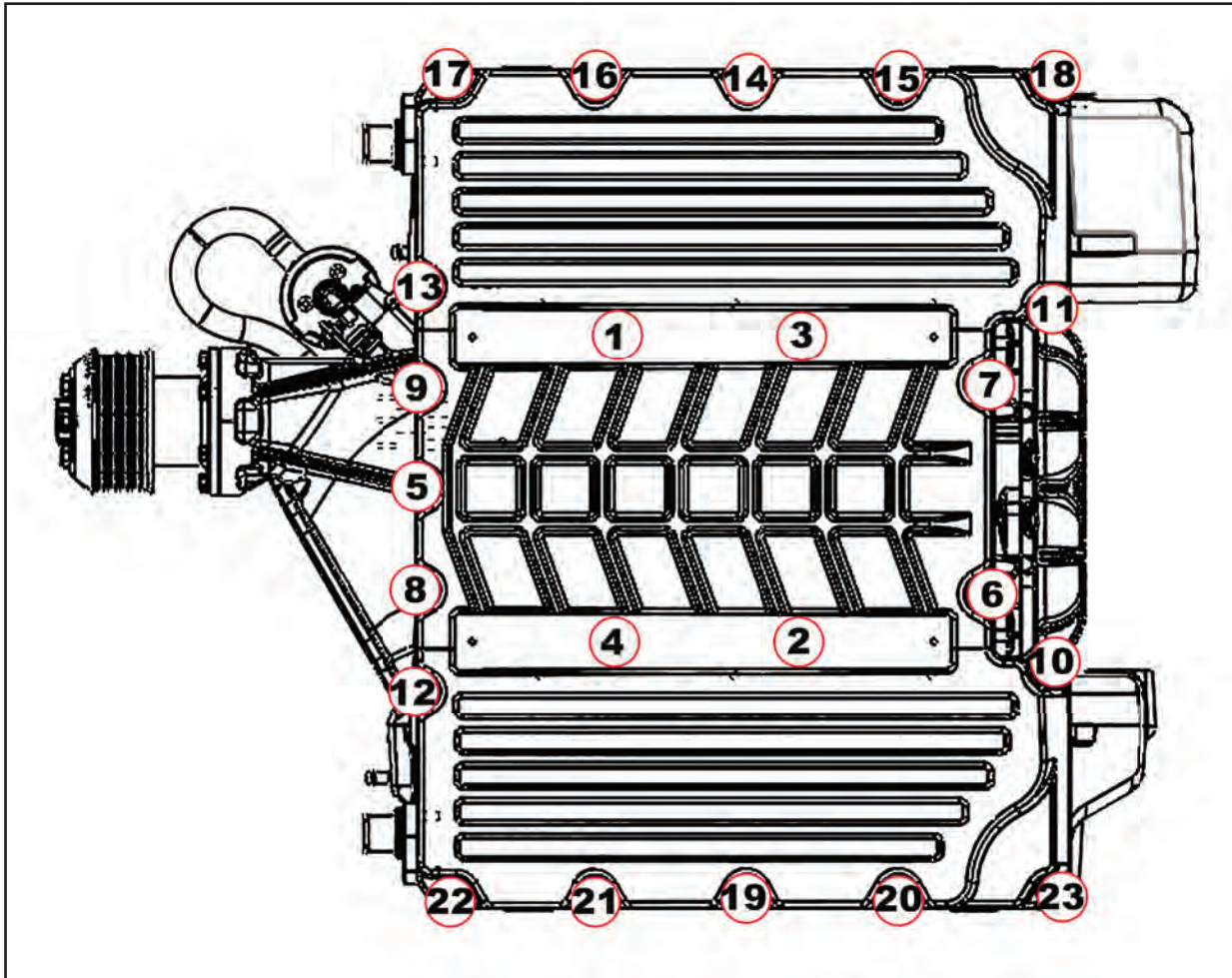

Lid to Supercharger Housing: 106in-lbs



Please enjoy your "Magnuson SuperCharged" performance responsibly.

Use only premium gasoline fuel, 91 octane or better.

MAGNUSON
SUPERCHARGERS