

MAGNUSON

SUPERCHARGERS

Installation Instructions for:
Intercooled Supercharger System
2014-2018 6.2L Magnum DI
Sierra/Silverado Truck



Step-by-step instructions for installing the best in
supercharger systems.

*** PREMIUM GASOLINE FUEL REQUIRED ***



ATTENTION!

**Your MAGNUSON SUPERCHARGER kit
is sensitive to corrosion!**

**Use only the vehicle manufacturer
recommended coolant for your engine in
the intercooler system as well.**

Magnuson Superchargers
1990 Knoll Drive, Bldg A, Ventura, CA. 93003
(805) 642-8833
magnusonsuperchargers.com

INSTALLATION MANUAL

Magnuson Superchargers Magnum DI
Intercooled Supercharger System
GM 6.2L DI Engines

Please take a few moments to review this manual thoroughly before you begin work: Make a quick parts check to be certain your kit is complete (see shipper parts list in this package). If you discover shipping damage or shortage, please call your dealer immediately. Take a look at exactly what you are going to need in terms of tools, time, and experience. Review our limited warranty with care. When unpacking the supercharger kit **DO NOT** lift the supercharger assembly by the black plastic bypass actuator. This is pre-set from the factory and can be altered if used as a lifting point!

Caution: Relieve the fuel system pressure before servicing fuel system components in order to reduce the risk of fire and personal injury. After relieving the system pressure, a small amount of fuel may be released when servicing the fuel lines or connections. In order to reduce the risk of personal injury, cover the regulator and fuel line fittings with a shop towel before disconnecting. This will catch any fuel that may leak out. Place the towel in an approved container when the job is complete.

This supercharger system requires the use of only premium gasoline fuel, 91 octane or better. It is NOT compatible with E85, Ethanol, or Flex fuels.

Magnuson Superchargers recommend that you run a minimum of one (1) tank of premium fuel through your vehicle prior to installation of the system to prevent any possible damage that may occur due to running the supercharged engine on lower octane fuel. **DO NOT add octane booster to your vehicle.**

Magnuson Superchargers systems are designed for engines and vehicles in “GOOD” mechanical condition. Magnuson Superchargers recommend that a basic engine system “Health Check” be performed prior to the installation of this supercharger system. Be sure to check for any pending or actual OBDII codes and fix/repair any of the stock systems/components causing these codes. If there are codes prior to the installation they will be there after the installation.

Magnuson Superchargers also recommend the following services to be performed on your vehicle before starting and running the vehicle post supercharger system installation:

- Fuel and Air Filter change
 - Engine oil and oil filter change using the vehicle manufacturer’s specified products
- NOTE: It is VERY IMPORTANT to use the factory specified oil viscosity. The original equipment manufacturer has selected this grade of oil to work with your other engine systems such as hydraulic chain tensioners and variable cam controls. Deviation from this specification may cause these systems to fail or not function properly. Please refer to your owner’s manual for the recommended oil viscosity for your engine and application.
- On newer vehicles not requiring new spark plugs it is important to verify the spark plug air gap.

On older vehicles Magnuson Superchargers recommend these additional services to be performed:

- New spark plugs with the air gap set at the factory specifications OR new specifications if required by the installation manual.
- Engine coolant system pressure test, flush and refill.
NOTE: YOU MUST USE THE GM SPECIFIED COOLANT MIXTURE!
- Non “Magnuson Approved” calibrations or “tuning” will Void ALL warranties and CARB certification.

Tools Required

- Safety glasses
- Metric wrench set
- 1/4", 3/8", and 1/2" drive metric socket set (standard and deep)
- 3/8" and 1/2" drive foot pound and inch pound torque wrenches
- 1/2" breaker bar (for belt tensioner)
- Phillips, flat and Torx head screwdrivers
- Plastic and steel pry bar
- Pliers, cutters, metal pick, magnetic telescoping pickup tool and funnel
- Engine Hoist
- Ø1.75" Hole Saw

Parts Needed

If you have a 5.3L engine you will need to purchase a GM 6.2L Throttle Body (GM Part#12678223)

IMPORTANT

NOTES:

- 1. For the purpose of these instructions, all references to left hand side or right hand side shall be interpreted as if being seated in the driver seat of the vehicle.**
- 2. It is IMPORTANT to utilize 91 Octane gasoline or better with your supercharger system. Before starting this installation, on an empty tank, fill your tank to full with 91 Octane gasoline or better.**
- 3. Never add Octane booster to your fuel. If you have used Octane Booster in the past, replace your spark plugs and check your O2 sensors before completing your supercharger install.**
- 4. Your supercharger system is sensitive to corrosion. Use only the OEM recommended coolant mixture for your supercharger system as well as your engine.**
- 5. Please remember to follow all safety rules that apply when working, including:**
 - **Wear eye protection at all times**
 - **Do not work on a hot engine**
 - **Be careful around fuel – use shop towels to catch any spills and dispose of towels properly**

Contact Information:

Magnuson Superchargers
1990 Knoll Drive, Bldg A
Ventura, CA 93003

Sales/Technical Support Line: (805) 642-8833
Website: www.magnusonsuperchargers.com
Email: sales@magnusonsuperchargers.com

Supercharger Belt: Gates Micro-V K06100

Notes

Table of Contents

Section 1: Tuning Vehicle Computer and Initial Steps	6
Section 2: Remove Fascia Grill and Factory Intake Manifold	7
Section 3: Front End Tear Down for LTR Installation	16
Section 4: Installing LTR, Reservoir and Pump	22
Section 5: Intercooler Hose Routing and Wiring	26
Section 6: Supercharger Idler Installation	32
Section 7: Preparing for Supercharger Installation	37
Section 8: Supercharger Installation	40
Section 9: Idler Bracket, Belt Installation and Wiring	46
Section 10: Intercooler Hose and Inlet Air Tube Installation	52
Section 11: Coolant Fill and Final Testing	57

NOTE: For the purpose of these instructions all references to left or right side are assumed to be as indicated from the seated position in the driver seat of the vehicle.

Section 1: Tuning Vehicle Computer and Initial Steps

1. If your kit has a provided handheld tuner follow the instructions in the provided pamphlet to install your tune. Your handheld tuner may not match the one shown.



2. Your Intercooler system is sensitive to corrosion. It's very important to use the OEM recommended engine coolant mixture in your supercharger system as well.



3. Your system requires the use of minimum 91 Octane gasoline fuel. This system is **NOT** compatible with E85 fuel.



4. Loosen the nut shown with an arrow to disconnect the negative battery terminal using a 10mm socket wrench. Cap or cover the terminal to protect against accidental contact with the battery post.



Section 2: Remove Fascia Grill and Factory Intake Manifold

5. Remove the twelve push pin rivets from the top of the radiator cover by prying up on the center pin to release the spreaders, then pry up on the outer ring and pull the push pins free. There are two alignment tabs at the front that pull straight up to release. Remove the cover and set aside for later reinstall.



6. **This does not apply to the 2017 or newer Sierra/Silverado.** Remove the front wheel well fender trim from both sides by removing the 6 bolts located around the perimeter.



7. **This does not apply to the 2017 or newer Sierra/Silverado.** In the fender well, use a 7mm wrench to remove the two bolts (on each side of the vehicle) at the front skirt holding the fascia/grille bottom panel to the sub-frame.

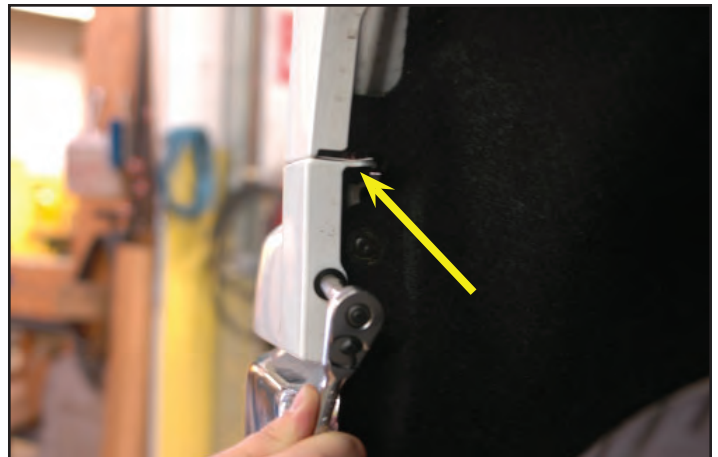

8. **This does not apply to the 2017 or newer Sierra/Silverado.** Carefully pull out on this fascia bottom panel to unsnap it from its location.



9. This photo shows the hidden locations for the six clip retainers (shown with yellow arrows) for the fascia bottom panel from the last step. Have an assistant hold the panel while you pry at these six locations to remove the panel. The red arrow locations show the four lower mounting areas for the grille that will be referred to in the next step. (**Red arrow locations are not on the 2017 or newer Sierra/Silverado**).

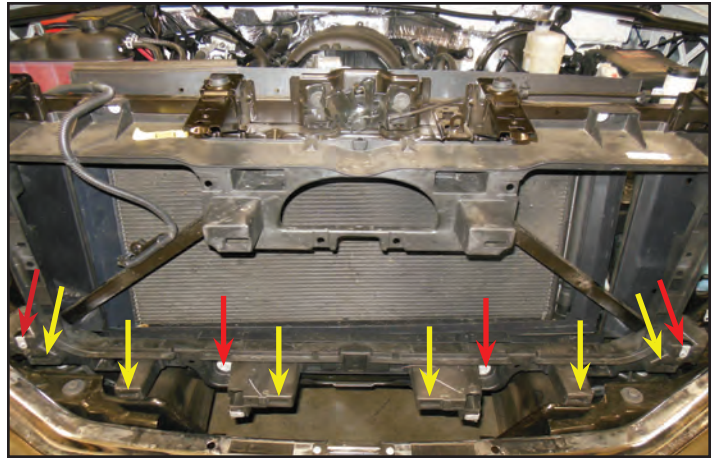

10. Remove the four bolts (shown with arrows) holding the top of the fascia/grille to the sub frame using a 10mm wrench. Also remove the four bolts from the lower portion of the grille that were mentioned in the last step.

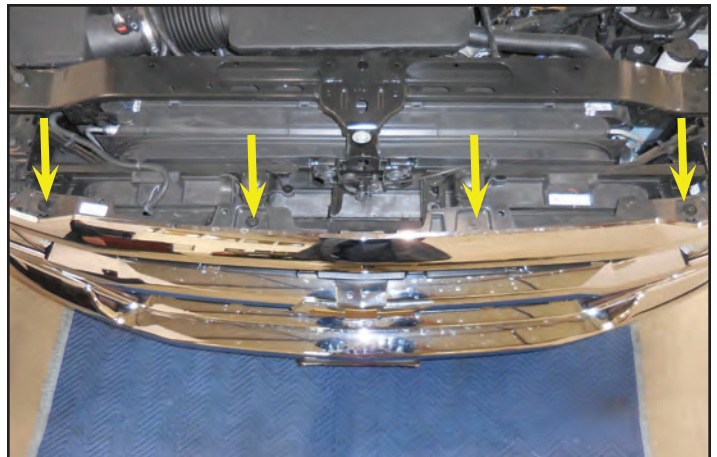

11. Pull straight out on the fascia/grille to disconnect the two remaining snap clips at the center of each side, and the bottom guiding slots. Set the fascia/grille aside carefully for later reinstall.



12. Depress the gray locking tab to release the PCV vent hose coming from the valve cover at the air plenum on both sides of the engine. These two hoses will not be reused.



13. Loosen the clamp at the air box securing the air plenum in position using an 8mm nut driver.



14. Using an 8mm nut driver or a flat blade screwdriver, loosen the clamp at the throttle body.



15. Remove the air intake plenum from the vehicle. This will not be reused.



16. Remove the clip holding the electrical cable shown using a plastic pry bar.



17. **This does not apply to the 2017 or newer Sierra/Silverado.** Remove the bolt securing the bracket in location shown using a 13mm socket wrench.

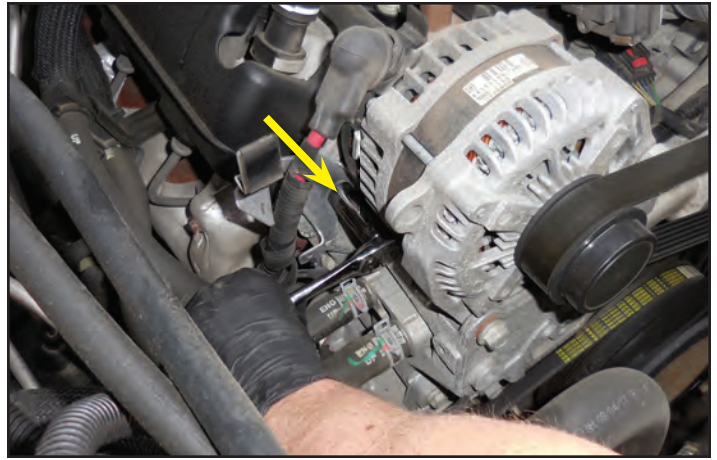

18. **This does not apply to the 2017 or newer Sierra/Silverado.** Here is the bracket removed in the last step. This bracket and the bolt will not be reused.



19. Pull the red tab on the ETC connector and pull the connector free.



20. Disconnect the alternator control sensor plug from the alternator.



21. Pull the four “tree” tab wire loom mounting anchors from the holes in the right, and left side of the intake manifold.



22. Release blue locking tab from the MAP sensor plug and pull it free from the MAP sensor. (See the next step if you are having difficulties.)



23. Use a pick tool to move the blue lock tab over from the inside if you can't get it to disengage with your finger from the outside.



24. Use a 10mm socket wrench to remove the EVAP Solenoid from the intake manifold. This is located just behind the throttle body on the left side, below the MAP Sensor.



25. With the EVAP Solenoid free you can now remove the electrical connection by pulling back, then pressing the release tab and unplugging.



26. With the EVAP solenoid free, you can now easily disconnect the EVAP tube from the solenoid by pressing the gray release tab and pulling free. Save the EVAP solenoid. The fastener will not be reused.



27. Remove the PCV hose from the valley cover on the left side below the throttle body.



28. **The 2017 or newer Sierra/Silverado** have the PCV hose as shown here at the arrow locations and must be removed.



29. **Some model years have other end of the PCV hose located mid way down the manifold on the driver's side.** Rotate the hose approximately 180° to gain access to the release tab on the left side valve cover, depress the tab and pull the hose free from the vehicle. Set aside for later usage.

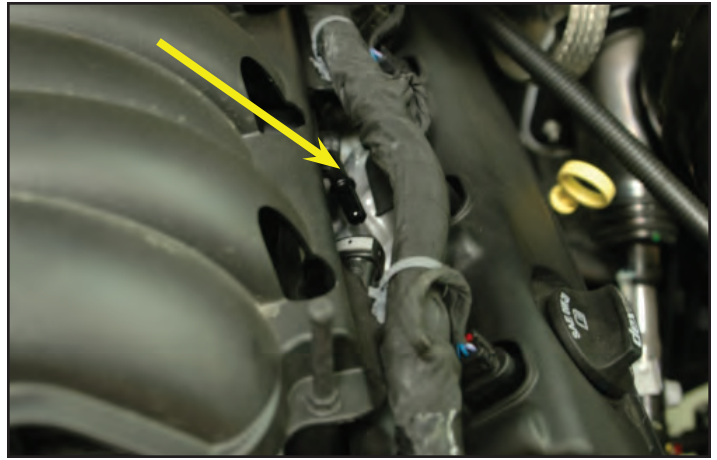

30. Use a 10 mm wrench to remove the nut holding the wire harness to the base of the bracket in front of the left side valve cover.

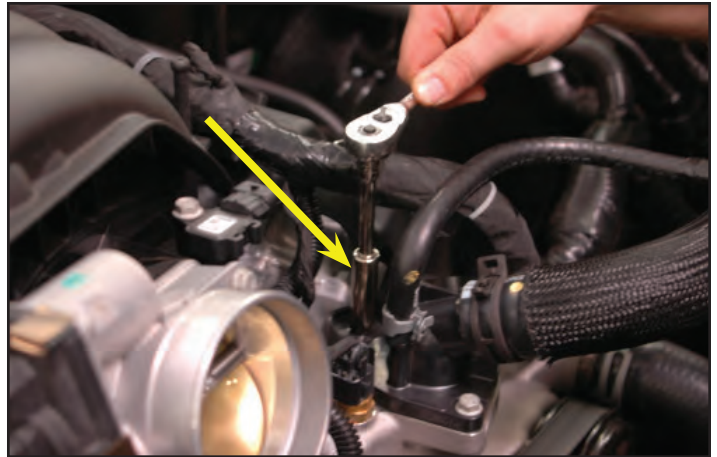

31. **This does not apply to the 2017 or newer Sierra/Silverado.** Use a 10 mm wrench to remove the bolt from the lower mounting bracket anchoring the wire harness.

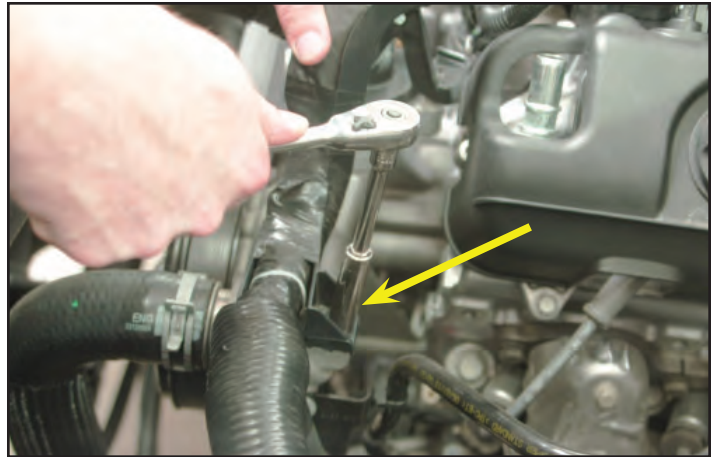

32. Use a 10mm socket wrench to remove the ten bolts securing the OEM intake manifold to the heads. The intake manifold is now ready for final removal from the vehicle.



33. **Be careful when pulling the manifold forward because the bolts can scratch the cylinder heads.** Pull the intake manifold forward a bit to gain access to the wiring harness “tree” anchors that hold the harness to the back of the intake manifold. Use a screwdriver or tree clamp remover to unplug these trees from the OEM intake manifold.

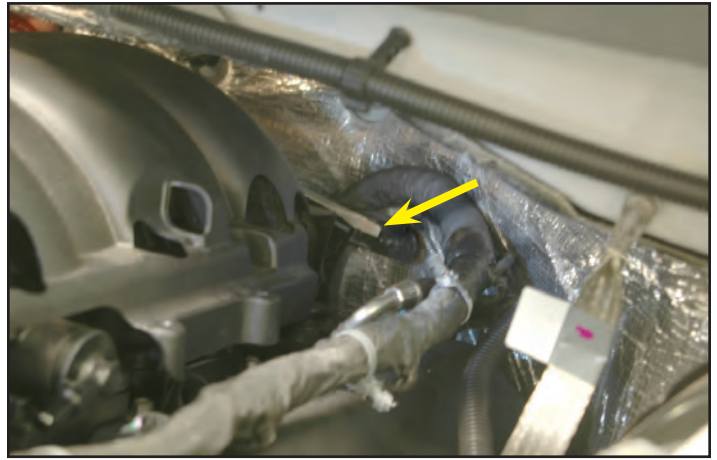

34. This image shows the location of the four tree connectors on the back of the intake manifold.

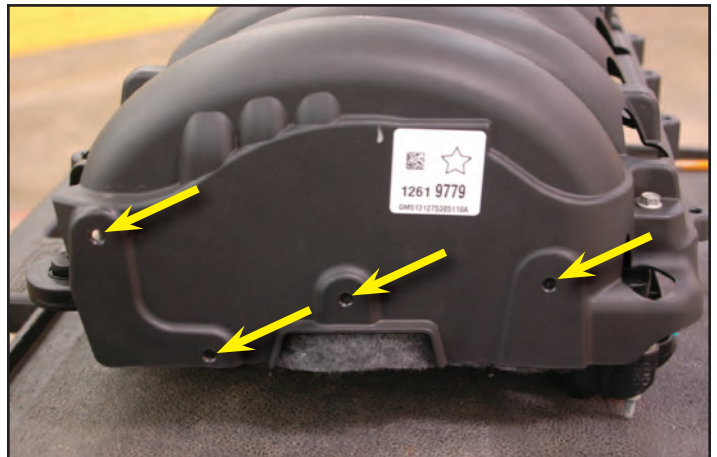

35. Pull the OEM intake manifold out of the vehicle and set aside. Parts will be used from this assembly. Gaskets, and throttle body will be reused.



36. Carefully wipe down the sealing surface around the intake ports with Simple Green or equivalent cleaner. Make sure to not allow any debris to enter the ports.



37. Apply tape to the ports to prevent any debris from entering the engine.



38. Remove the valley cover foam insulation from the vehicle. This cover will not be reused.



39. Remove the PCV hose from the valve cover.



40. Remove the oil filler cap.



41. Remove the plastic coil cover and reinstall the oil filler cap. Remove the coil cover on the passenger side as well.



42. Unplug the top connection to all the coil packs.



43. Unplug the spark plug wires for the back two coils on both sides. Mark the two rear coils on each side to ensure that they are installed in the original locations later. Remove the two bolts holding each of the two rear coil pack in using a 10mm wrench.



Section 3: Front End Tear Down for LTR Installation

44. Remove the two bolts shown with arrows holding the radiator bracket using a 13mm socket wrench.

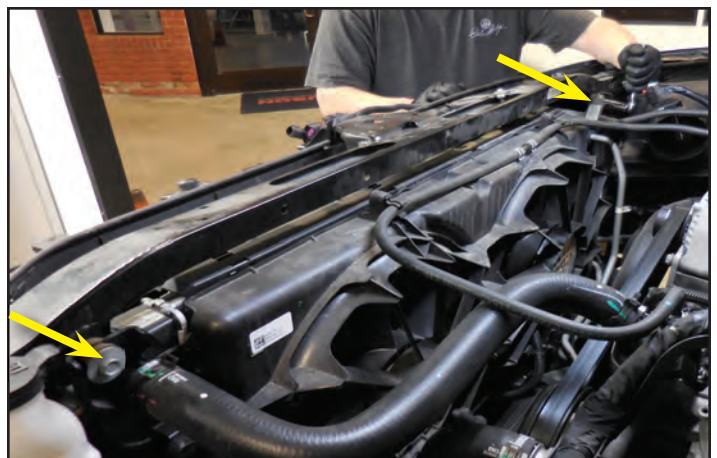

45. Remove the support bracket by unscrewing the two bolts shown with arrows using a 10mm socket wrench. Repeat this process on the passenger side.

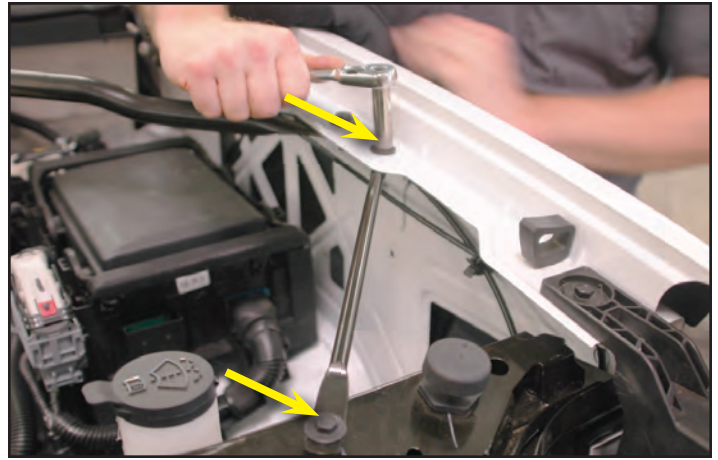

46. Pull the red tab on the MAF connector and unplug the connector.



47. Disconnect the cable tie at the arrow location. This cable tie will be replaced with a supplied one later.



48. Pull the factory airbox from the vehicle straight upwards. There are no screws anchoring the airbox in place. Three locating pins (shown below) push through grommets, so a firm pull will disconnect them. Set the airbox aside for installation in a later step. **Check the air filter inside and replace if necessary.**

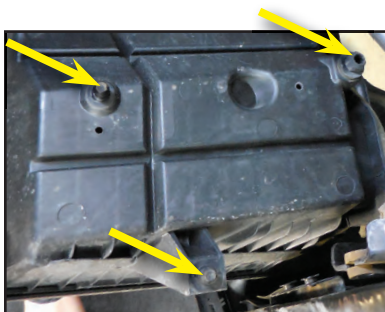

49. Next to the airbox location you will need to remove the two push pins shown with arrows.

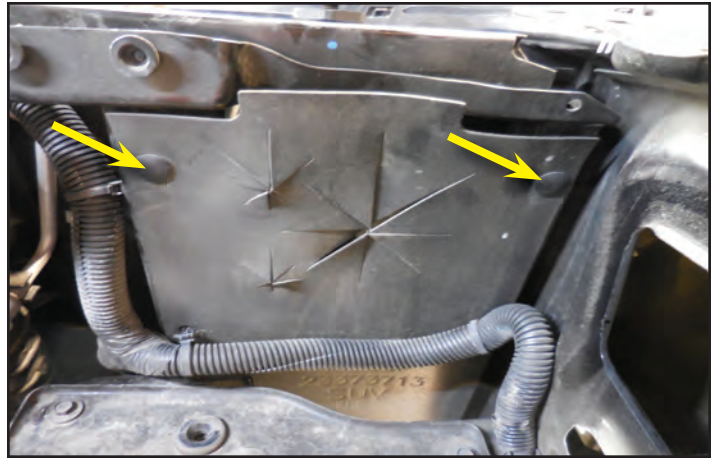

50. Behind the cover that you just removed you will find three bolts on the underside that will be removed to extract the radiator cross brace using a 10mm wrench. Refer to the photo that is 6 steps ahead for the 3 bolt locations on each side.



51. Remove the bolt for the window washer fluid tank near the lid and the one in the tray shown below. This will allow you to move the tank in order to access a radiator cross brace bolt using a 10mm socket wrench.



52. Remove the three upper radiator cross brace bolts on the driver's side using a 10mm wrench. These are all accessible from below the support brace. Refer to the photo that is 4 steps ahead for clarity.



53. Remove the cross-frame support brace center bolt using a 13mm wrench.



54. Remove bracket at the harness location shown. Depending on the electronics options, some vehicles may not have this connector and bracket.

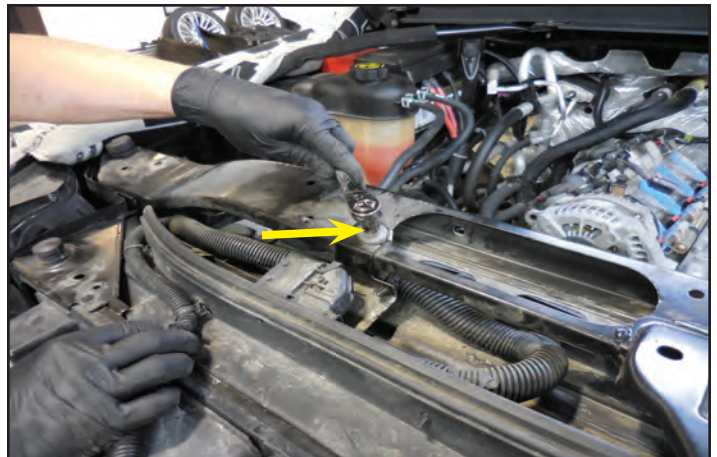

55. Pull the cross-frame support brace from the vehicle and set aside for re-installation in a later step.



56. The arrow locations here show the three threaded holes from one side of the support brace that was removed in the last step.

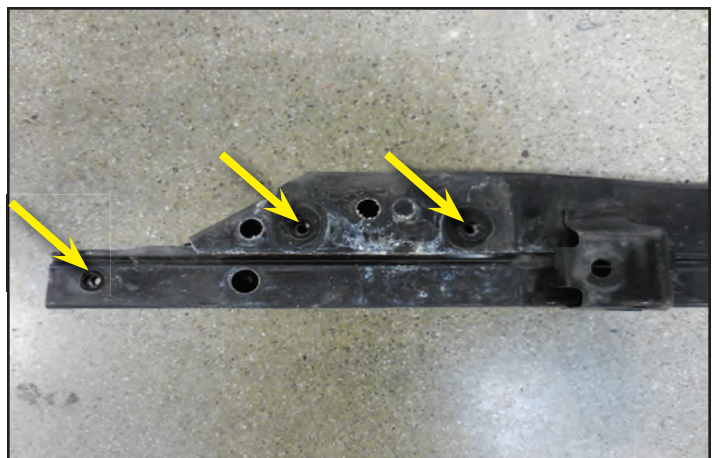

57. Pull up on the upper radiator shroud to unsnap it from the retaining slots, set aside for later re-install.



58. Remove the two retainers holding the hood latch release cable as shown with arrows.

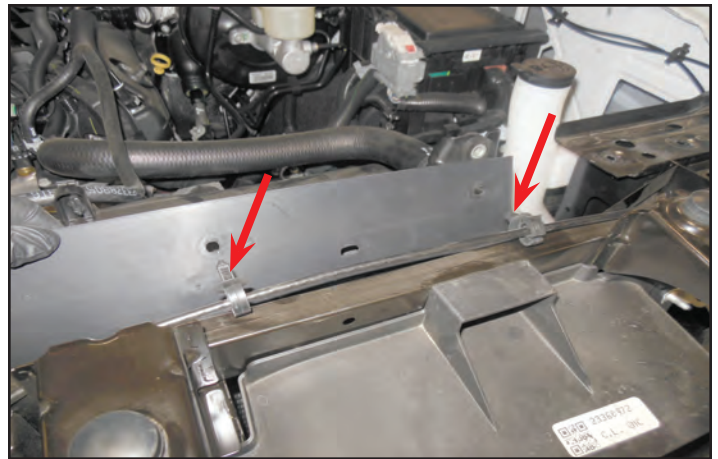

59. Remove the retainer holding the wiring harness shown with an arrow.



60. Remove the plastic push rivets from the plastic panel that is located around the radiator. This is the same shroud that retainer clips were removed from in the last two steps. There are 3 push rivets on top, 2 on each side, and 3 on the bottom. All the rivet heads are hidden from view in this photo. The top and bottom rivets are located on the back sides of this panel.

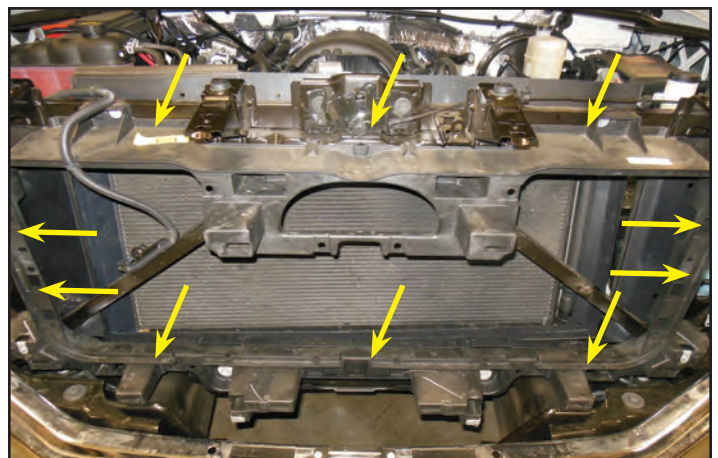

61. Here you can see the three lower locations after the rivets have been removed.



62. Once the rivets have been removed you will have to pull the sides of the panel inward to release them from their locations as you pull upward. **Be careful not to damage any radiator fins while you remove this panel.**



63. Here you can see the panel from the last step being removed.

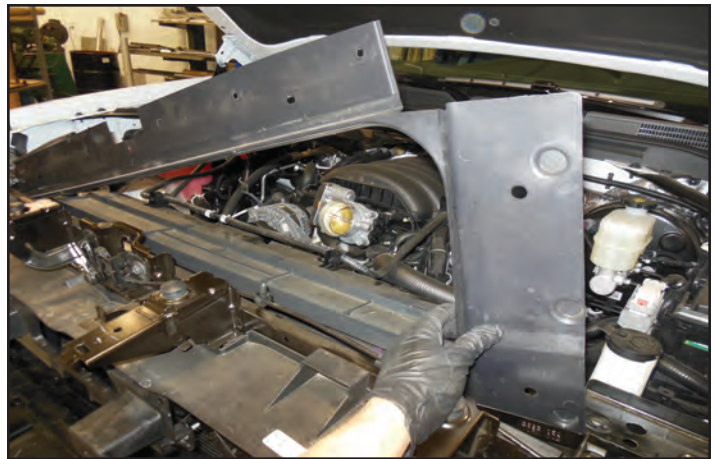

64. Cut out the provided template for your vehicle and install it in the location shown on the panel just removed. **There is a specific template for the Sierra or Silverado.** Use this template to mark the location for the two holes, and cut the holes out using a rotary tool or knife.

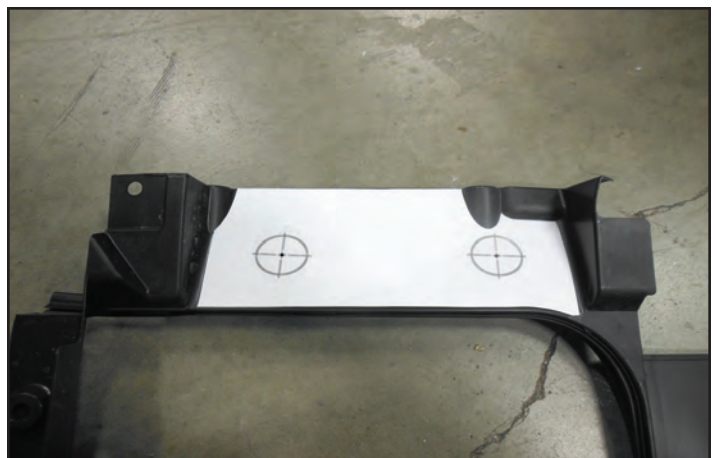

65. Install the two provided grommets at the hole locations. Now re-install the panel back into its original location using the OEM push rivets.



Section 4: Installing LTR, Reservoir and Pump

66. Slide the provided low temperature radiator (LTR) assembly at an angle as shown into the space created by pushing the radiator assembly top section toward the rear of the vehicle. The mounting brackets should be pointing forward, and the hose barbs on the right side of the vehicle. **Be careful to not damage the existing radiator or the LTR.**

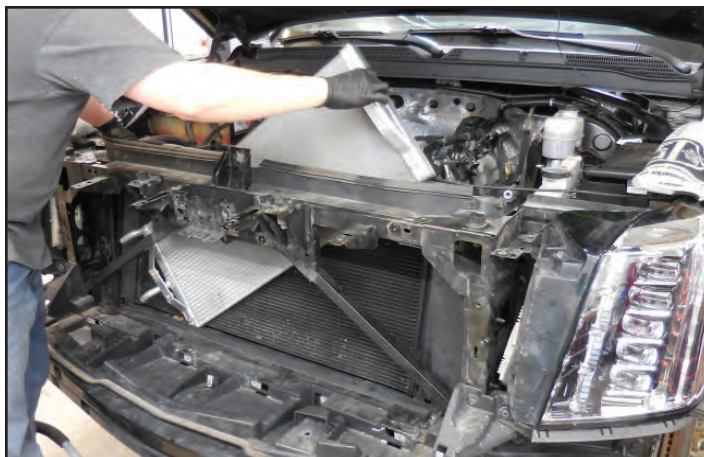

67. The LTR should now be resting on the bottom tray forward of the radiator. Center the unit and use the mounting bracket holes to align and place the mounting brackets on the "A-Frame" in front of the radiator.

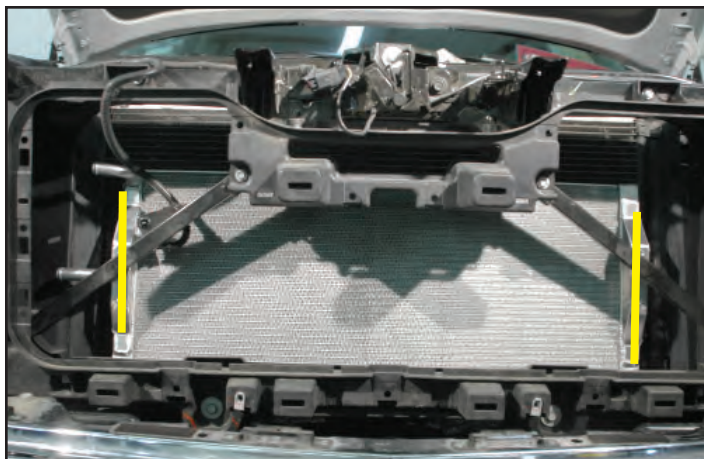

68. Install the provided grommets in the arrow location on the provided LTR mounting bracket.

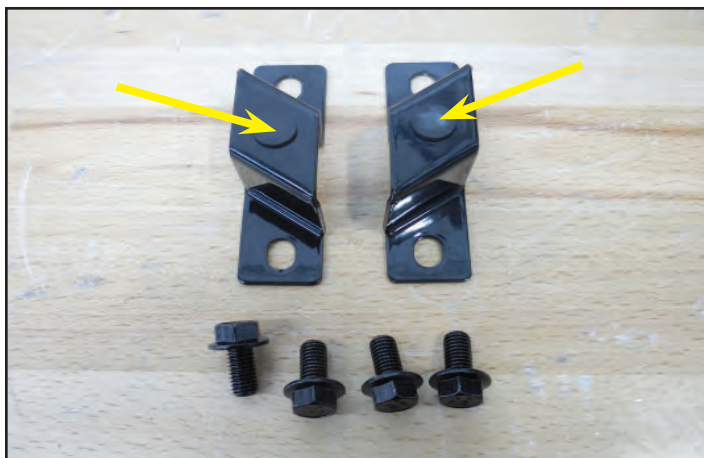

69. Attach the mounting brackets to the LTR mounting flange using the supplied bolts and a 12mm wrench. **Do not tighten until you have aligned the LTR to be level, cross checking against the existing horizontal lines of the A/C condenser.** Secure in place when you've got proper alignment.

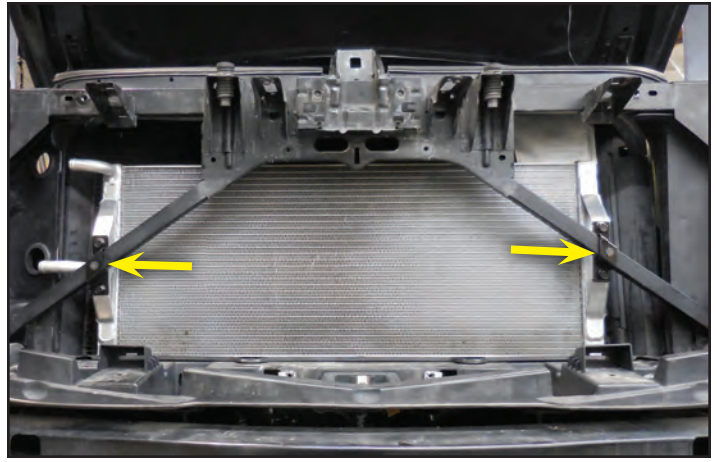

70. **Torque the 4 bolts from the last step to 18ft-lbs.** using a 12mm socket wrench.



71. Hand tighten the supplied coolant reservoir onto the provided bracket with the three M6x12mm bolts using a 10mm socket wrench.



72. Remove the two nuts holding the master cylinder to the brake booster canister using a 15mm socket. One location is shown with an arrow in this image. The other nut is located on the opposite side.



73. Replace the nuts incorporating the reservoir assembly. **Torque to 25 ft-lbs.** Verify your torque wrench settings.



74. On the driver's side outer frame rail remove the bolt holding the plastic cover shown at the arrow using a 13mm socket wrench.



75. Remove the plastic rivet at the arrow location and remove the plastic cover. This cover will be reinstalled later.

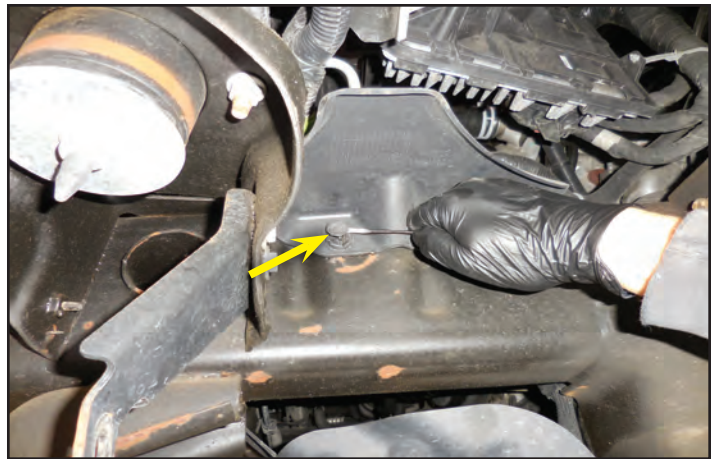

76. **The following locations may vary slightly between make and model years.** Remove the 6 mounting bolts for the rock guard, and remove the guard. Use a 15mm socket for the two bolts with red arrows, and a 10mm socket for the other four at the yellow arrows.

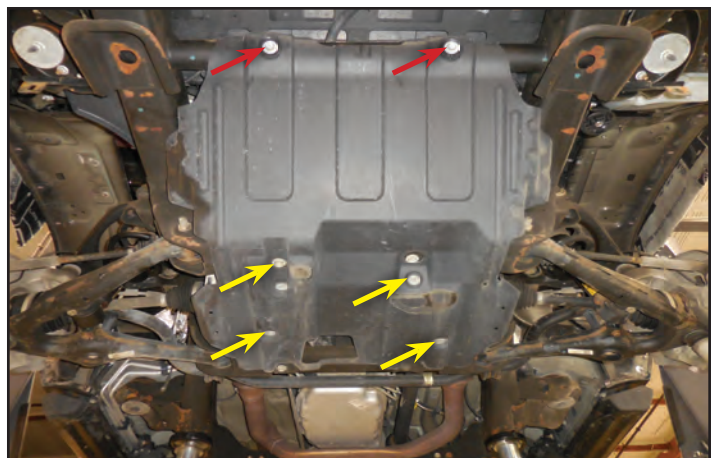

77. Gather the following provided brackets.

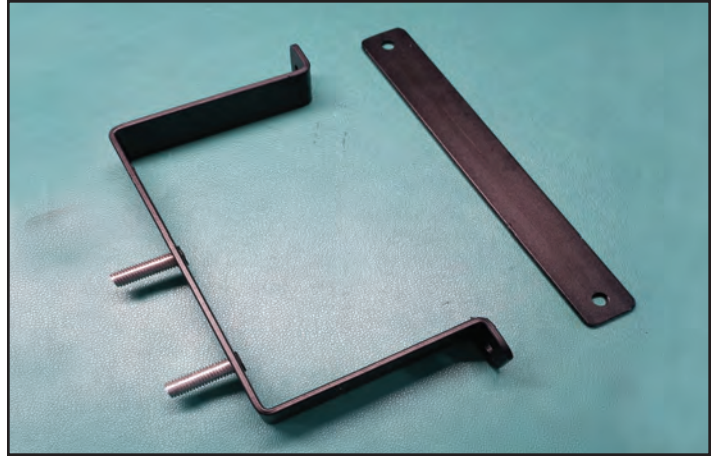

78. Install the bent bracket from the last step on the left inner frame rail with the studs towards the top. Orient the bracket 2.5" from the cross support as shown in the image.

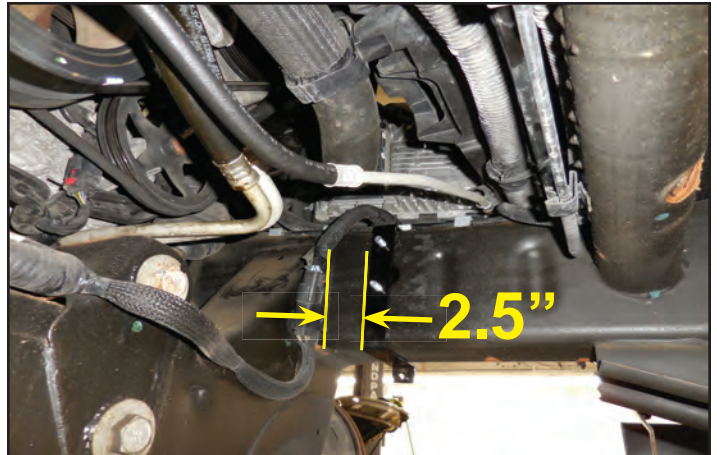

79. This image shows the opposite side of the frame rail from the last step. Apply Loctite 242 to the provided M6x20mm bolts and use them to attach the flat bracket from two steps to the bracket from the last step. **Torque to 120 in-lbs.**

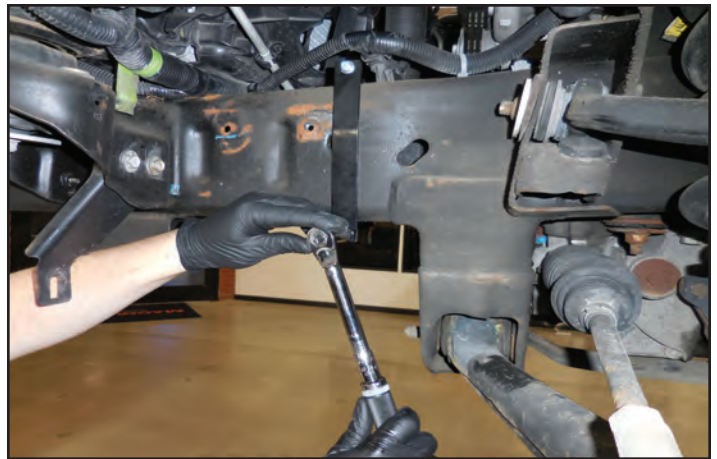

80. Reinstall the plastic panel with the plastic rivet and bolt. Verify the position of the installed bracket matches the picture and did not shift during assembly.



81. Install the coolant pump with the two provided Adel clamps and two M8 nuts at the yellow arrow locations. Ensure that the pump output barb is facing the direction of the green arrow. Ensure that the lower Adel clamp is about 1/2 inch from the bottom as shown. Be careful not to over tighten the M8 nuts, this can cause the Adel clamps to bend.

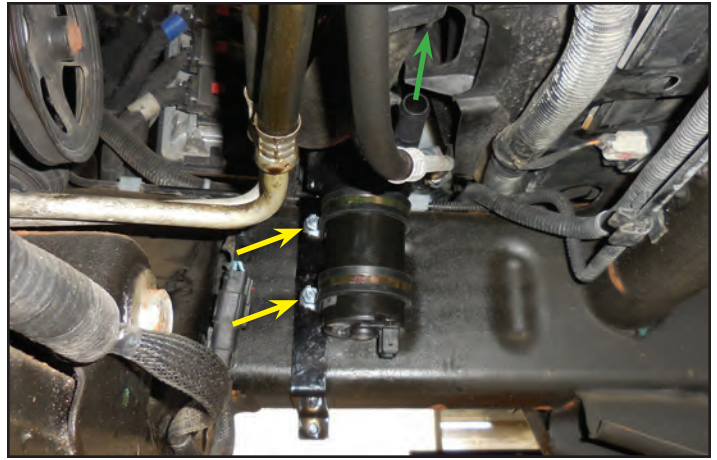

82. Here is an additional image showing the direction of the pump output with an arrow.



Note: Some hose assembly steps will not be required in the future as pre-made hose kits get manufactured. Premade hose kits will have mesh already installed on the hoses.

Section 5: Intercooler Hose Routing and Wiring

83. Cut the 4"x60"x3/4" 90° hose to 43" measured from the outside edge of the hose. Cut the short side to 3.5" measured from the outside edge. Gather the supplied 47" long mesh and install it over the hose as shown.

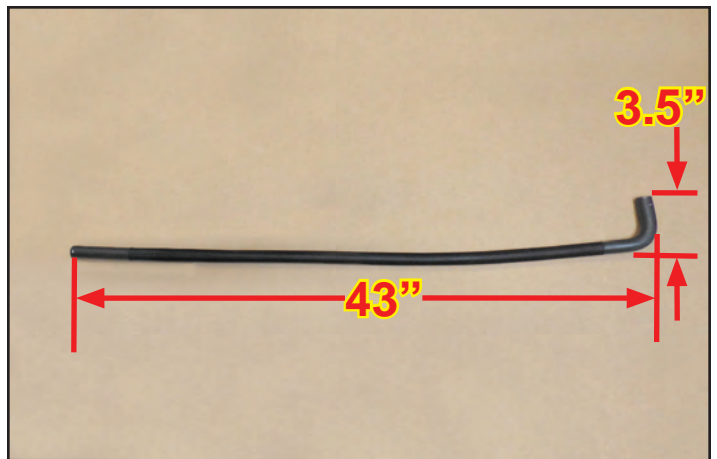

84. Slide one of the provided spring clamps over the lower LTR barb.



85. Slide the hose from two steps ago through the grommet and over the lower LTR hose barb and secure with the clamp as shown. The short elbow end connects to the LTR shown here.



86. Feed the opposite side of the hose from the last step through the arrow location shown.

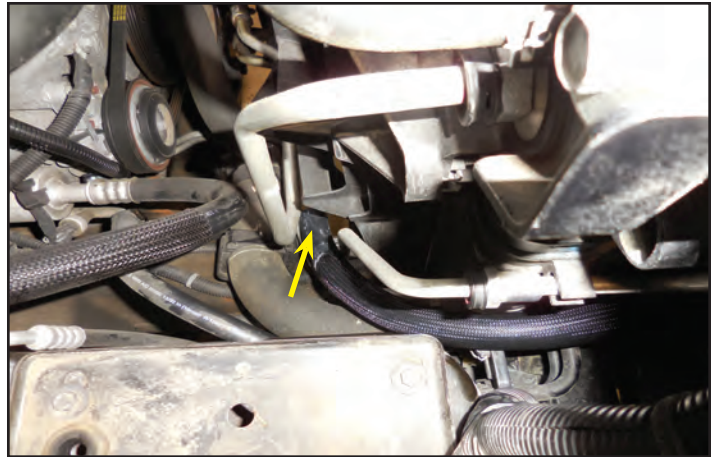

87. Continue to feed the hose from the last step (highlighted in green) over to the coolant pump and secure at the pump output with a provided spring clamp at the arrow location.

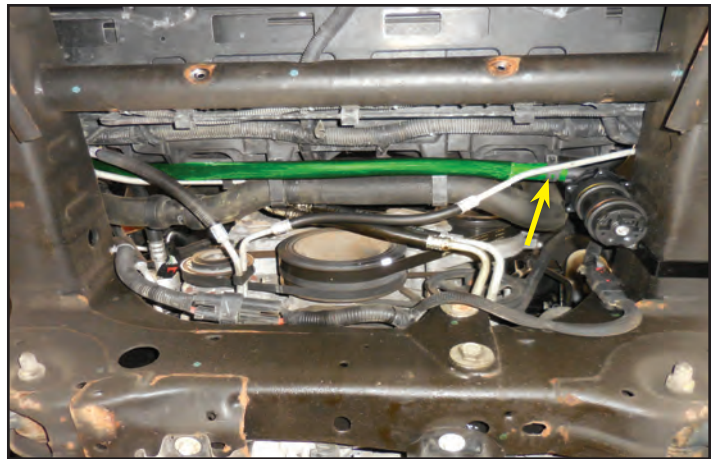

88. Install a provided cable tie (highlighted in green) at the arrow location around the wiring harness. Ensure that this is snug to avoid restriction on the hose. Trim the end off the cable tie.

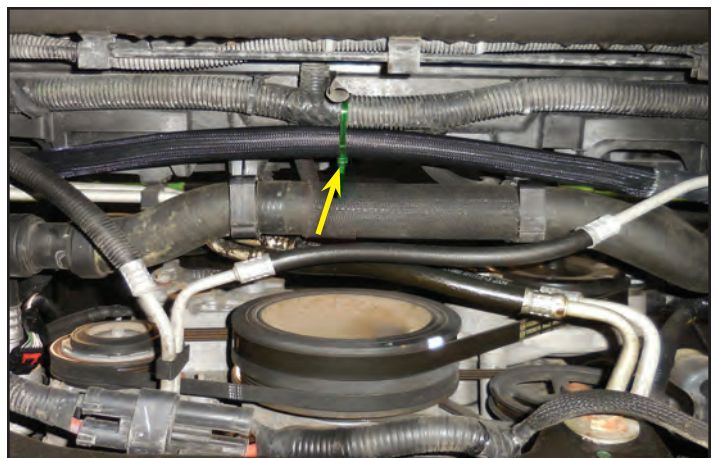

89. Install the provided 29" mesh over the provided 3/4" hose that is 27" long as shown.



90. Connect the end of the hose (highlighted in green) from the last step that has less mesh coverage on the front reservoir barb and secure with a worm gear clamp at the yellow arrow. **You must use a worm gear clamp to get a proper seal at the reservoir.** Route the hose down to the inlet of the coolant pump and secure with a provided spring clamp at the red arrow. It may be easiest to access the pump clamp from the driver's side wheel well.

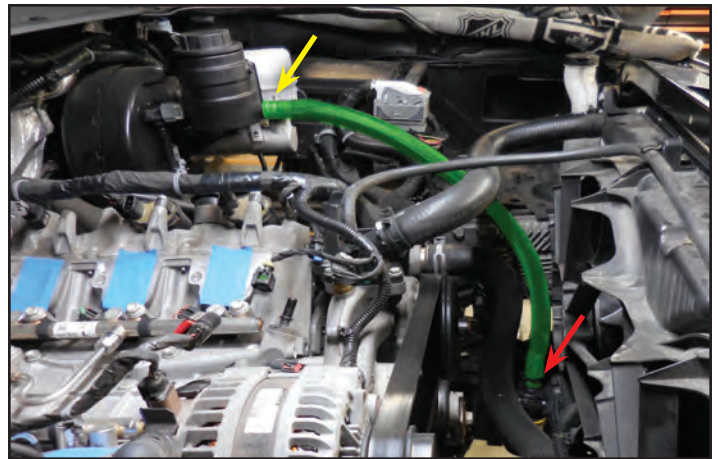

91. Remove the two nuts at the arrows just below the driver's side hood hinge using a 13mm deep well socket.



92. Gather the bracket shown below and install it at the two threaded studs and tighten in place with the original nuts.



93. Gather the provided intercooler pump harness and install the provided 15A fuse. Reinstall the cover once you are done.



94. Install the fuse housing and the relay in the arrow locations. Secure in place with the provided serrated flange nuts using a 10mm socket wrench. Make sure the wire loom is protecting the wires near the sheetmetal edges. Double check later as well.



95. Route the intercooler pump wire following the path highlighted in green. Place three tie wraps at the arrow locations securing it to the adjacent wiring harness. (The wheel well cover is removed for clarity. You can remove it if you want to aid in routing the wire.)

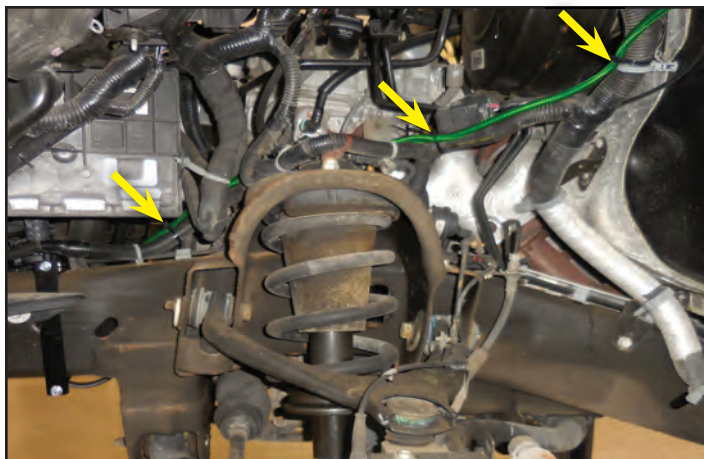

96. Plug in the electrical connection at the arrow location on the coolant pump. Adjust routing if necessary to gain slack at the connector.



97. Route the intercooler pump ground wire (highlighted in green) above the brake booster housing. Remove the factory nut at the grounding location shown with the arrow using a 10mm socket wrench and place the eyelet from the coolant pump ground wire on the stud. Reinstall the nut to secure the two ground wires.

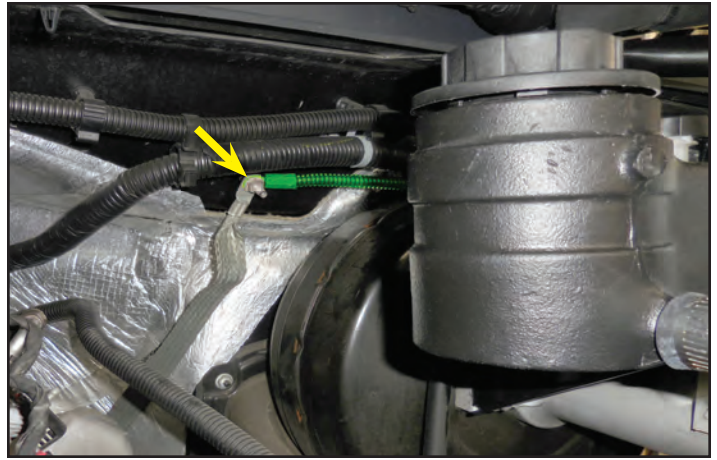

98. Remove the fuse box cover by pressing the two tabs (One shown here with an arrow) and pulling up.

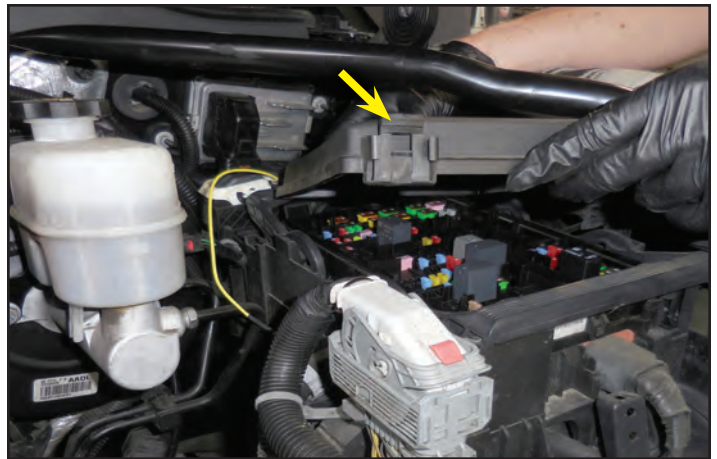

99. Flip the cover open for the positive lead at the back of the fuse center (red arrow location). Remove the nut of the positive lead (yellow arrow location) using a 13mm socket wrench. Replace the nut incorporating the eyelet terminal on the red wire from the intercooler wiring harness.

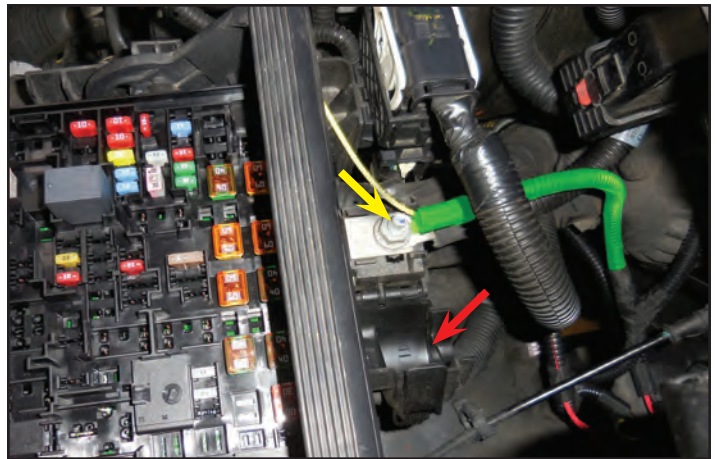

100. Create a notch at the green highlighted location shown with the arrow using side cutters and a file. This is where the yellow trigger wire will be located.

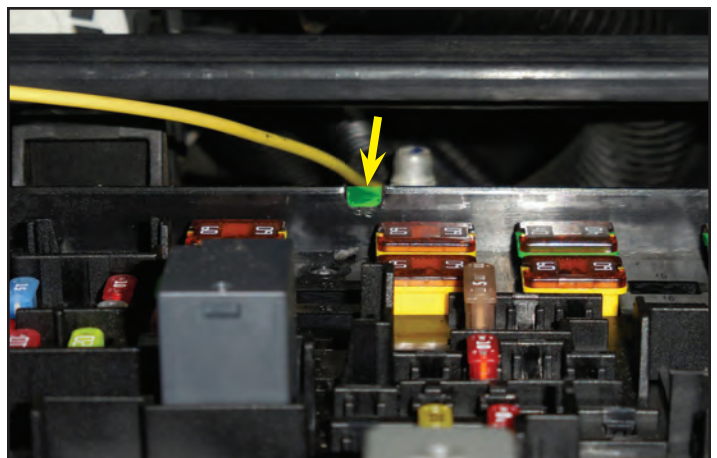

101. Notch the positive terminal cover to allow the yellow trigger wire some clearance.

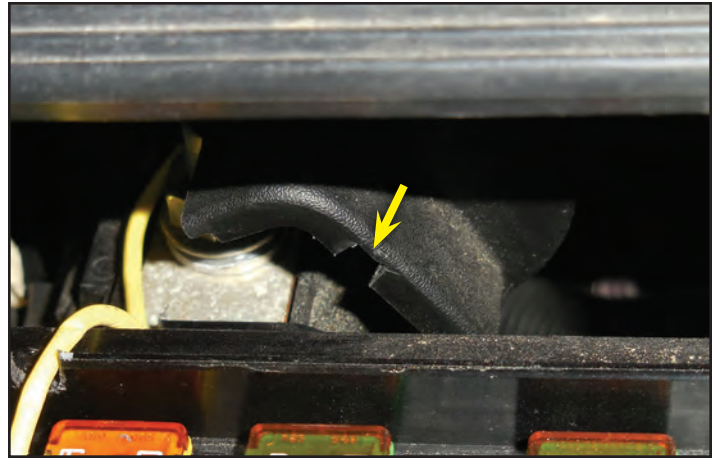

102. Remove the fuse number 74 (labeled: ECM IGN) from the slot in the fuse center shown here with an arrow.

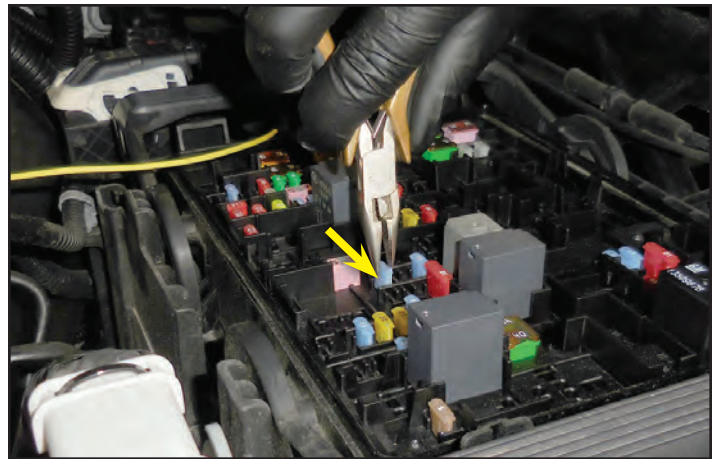

103. Connect the fuse tap end of the yellow wire from the intercooler wiring harness to one leg of the fuse just removed. It will be a tight fit.



104. Replace the fuse in slot number 74 (labeled: ECM IGN) with the fuse tap installed on one leg. Press the yellow wire down into the notch you created earlier at the red arrow.

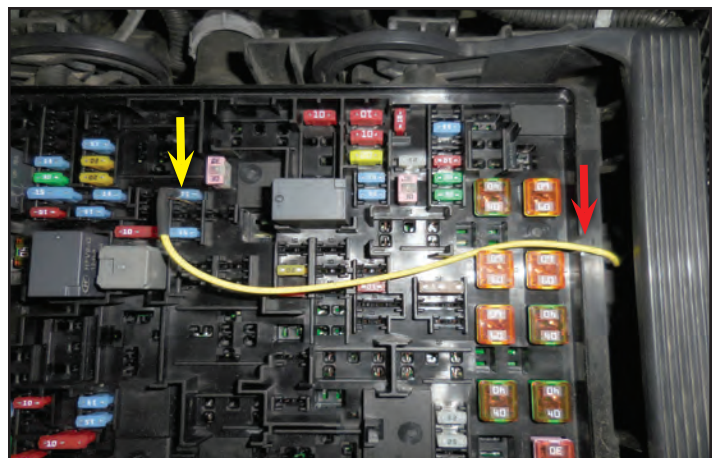

105. You will need to use needle nose pliers to push the fuse down tight into its location. Make sure the fuse is sitting evenly and not crooked.

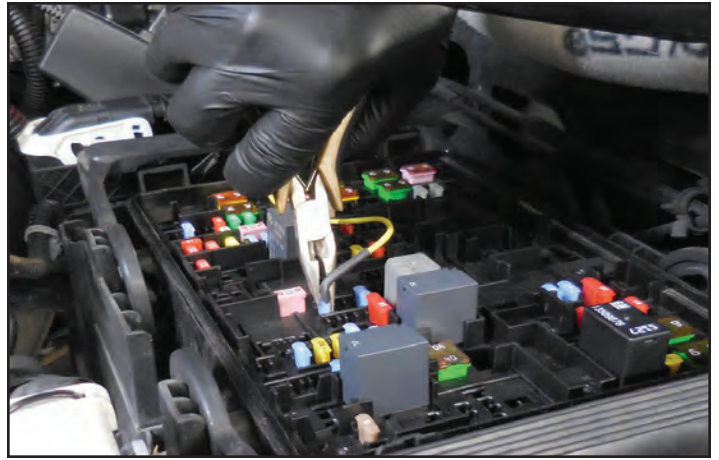

Section 6: Supercharger Idler Installation

106. Place a 1/2" drive breaker bar into the arrow location on the tensioner and rotate it counterclockwise to relieve the belt tension. Remove the belt, it will not be reused.

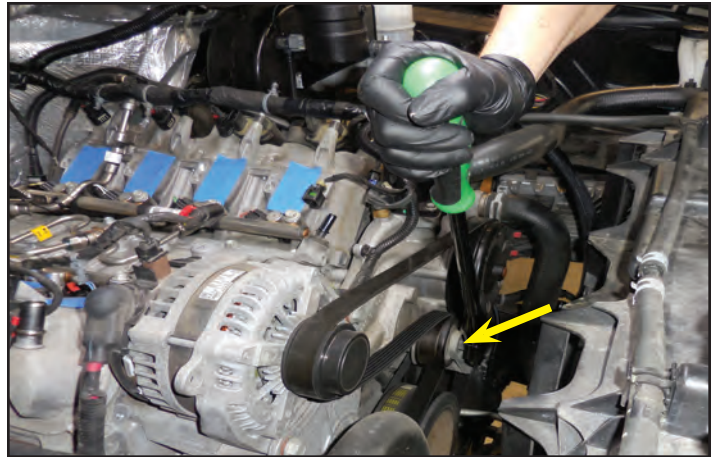

107. Remove the alternator mounting bolt shown using a 15mm socket wrench. This bolt will not get reused.



108. Loosen the other alternator support bolt shown. **Do not fully remove the bolt.**



109. If you have the bracket located next to the alternator remove it. This bracket will be re-attached later.

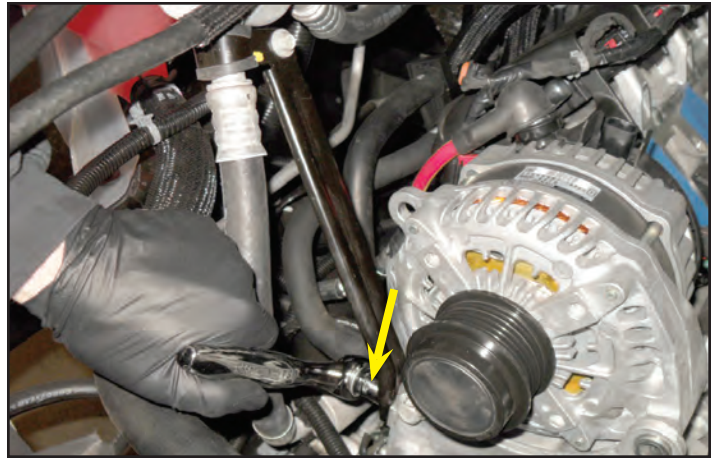

110. Pry alternator up to rotate it out of the way. This is done to gain clearance for the supercharger install.



111. Remove the bolt shown with an arrow using a 15mm socket wrench. This will be replaced with a longer bolt to install an idler.



112. Gather the provided ribbed idler, bolt and spacer shown.



113. Insert the spacer into the bearing as shown.



114. **Apply Loctite 242 to the supplied bolt** as shown below. Install the pulley with the spacer at the backside in the arrow location shown and **torque to 25 ft-lbs.**



115. Gather the provided smooth idler, bolt, washer and spacer shown.



116. Insert the bearing in the spacer as shown.



117. Apply Loctite 242 to the supplied bolt as shown below. Make sure the washer sits beneath the head of the bolt before tightening. Install the pulley with the spacer at the backside in the arrow location shown and **torque to 25 ft-lbs.**



118. This image shows the final location of both idlers.



119. Loosen the factory spring clamp at the yellow arrow and rotate the hose clockwise as seen from the top (red arrow) from this connection then secure in place with the clamp. This will allow more clearance away from the belt line.

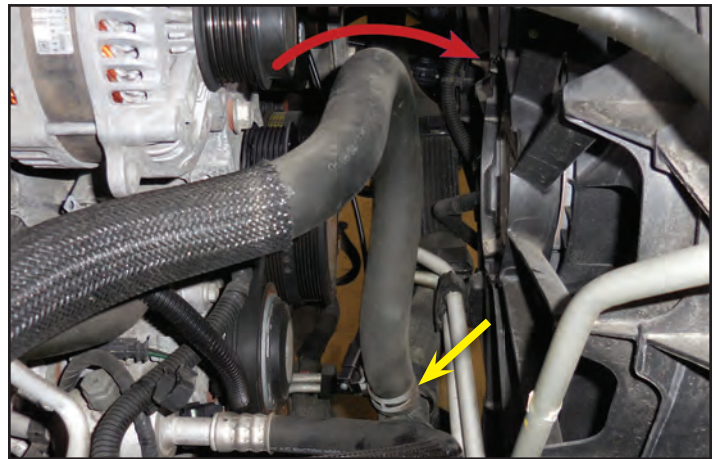

120. This top view shows the clearance necessary prior to adding the supplied cable tie.



121. Wrap the radiator hose with the provided mesh as shown with the arrow.

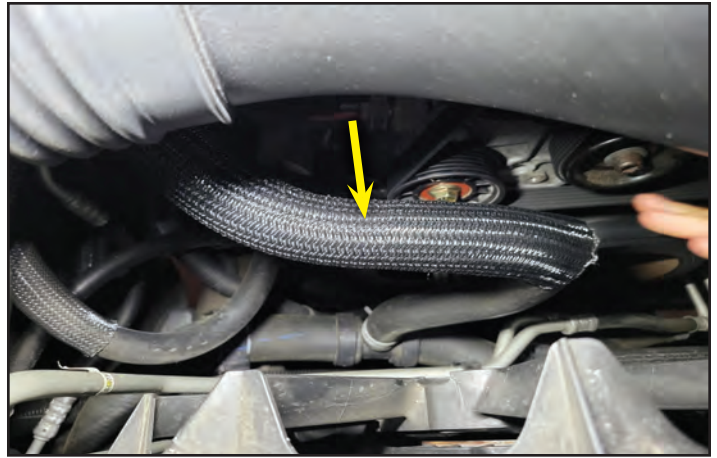

122. Gather the provided edge mount cable tie shown.



123. Remove the clip from the cable tie that was shown in the last photo and install it at the arrow location on the fan shroud.



124. Install the cable tie snugly at the clip location from the last photo to keep the hose from contacting the supercharger belt. Trim the excess cable tie from the end.

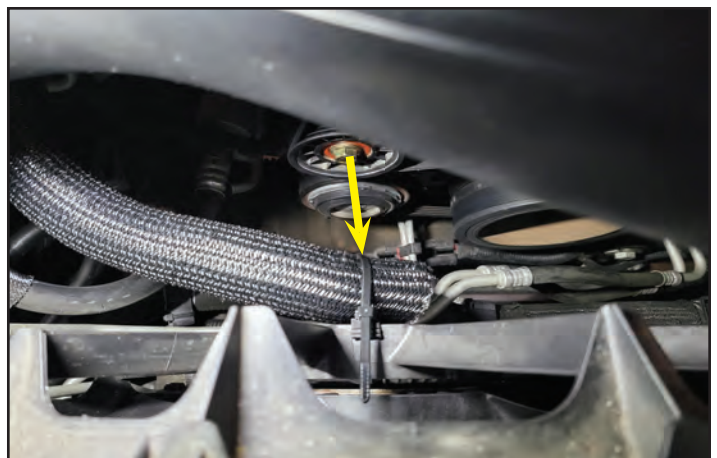

Section 7: Preparing for Supercharger Installation

125. Remove the fuel line safety clip by prying up at the side shown with the red arrow first, and then sliding off in the direction of the green arrow.

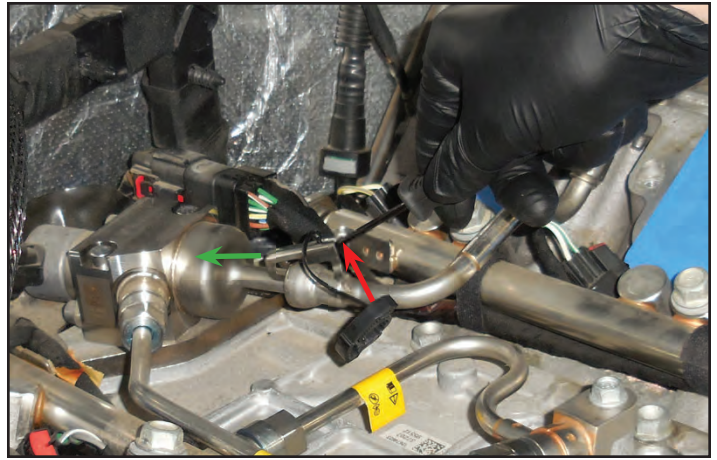

126. Remove the plastic tether shown from the safety clip, it will not be used.



127. Install the fuel line safety clip rotated to the side as shown here to allow more clearance for the supercharger.

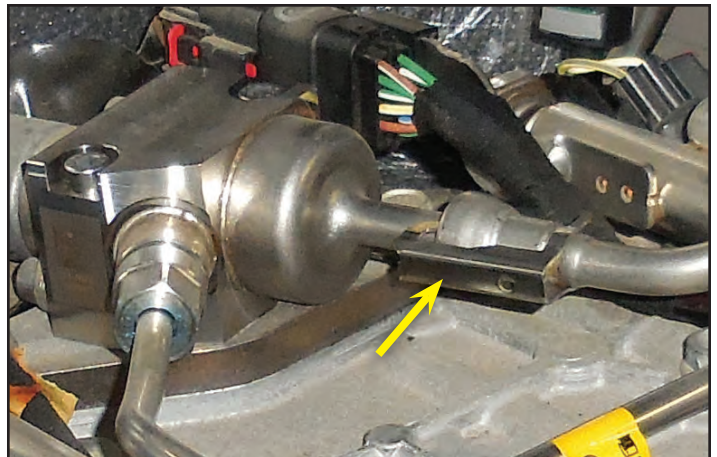

128. Remove the OEM cable ties from the ignition coil wires. There are 4 per side.



129. If you have a 6.2L engine you will remove the four bolts holding the throttle body in place. These bolts will not be reused. If you have a 5.3L engine you will need to purchase a throttle body (GM Part# 12678223).

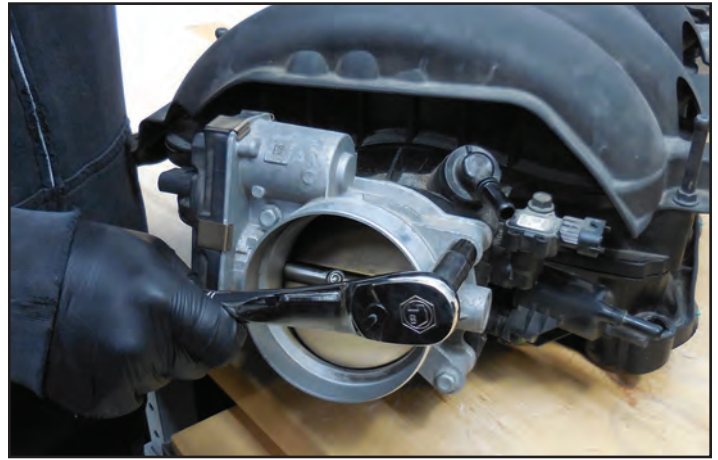

130. Clean the sealing surface of the throttle body.

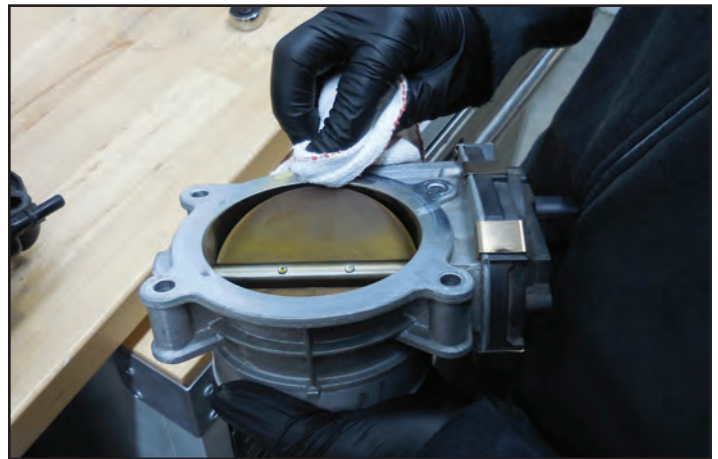

131. Gather the following provided M6x40mm bolts and apply Loctite 242 to them.



132. Remove the red inlet cap shown below. Gather the provided gasket shown and line up the tab (arrow location) and holes as shown to the right.

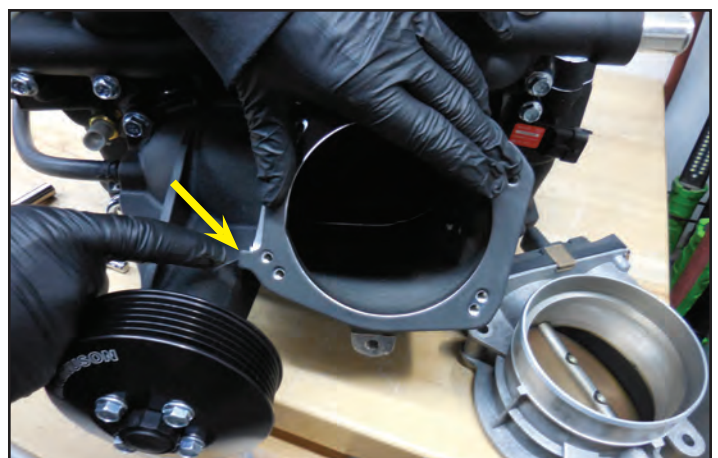

133. Rotate the throttle body so that it fits on the upper right most hole as shown, then line up all the other holes while you hold the gasket in place.



134. Install the four M6x40mm bolts with Loctite 242 on the throttle body and **torque them in two stages with the final torque of 130 in-lbs.**



135. Remove the 8 intake manifold gaskets at the bottom of the intake manifold by first pulling at the tabs. These will be installed on the supercharger housing. Note the location of the tabs shown with arrows here. Replace any damaged gaskets with GM part# 12626354. Wipe the gaskets with a clean dry shop towel.

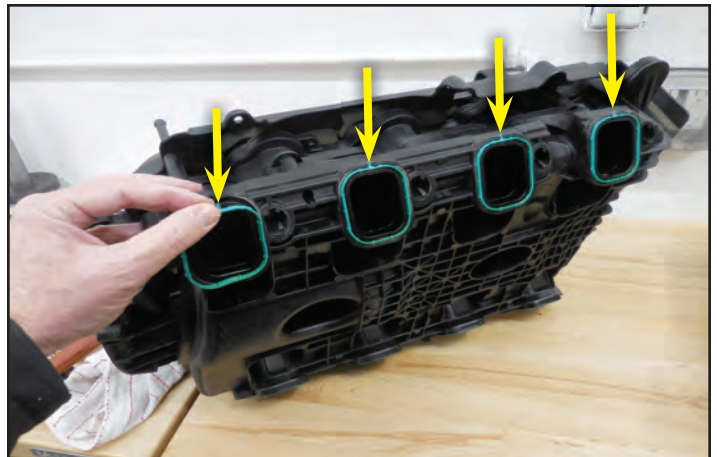

136. Install the 8 gaskets from the last step into the bottom of the supercharger as shown here. Ensure that the tab lines up with the notch in the top edge at the locations shown with yellow arrows. If you need to install a boost reference port you should do so now at the rear left of the supercharger shown below at the red arrow.

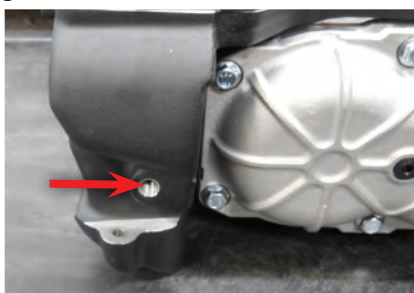
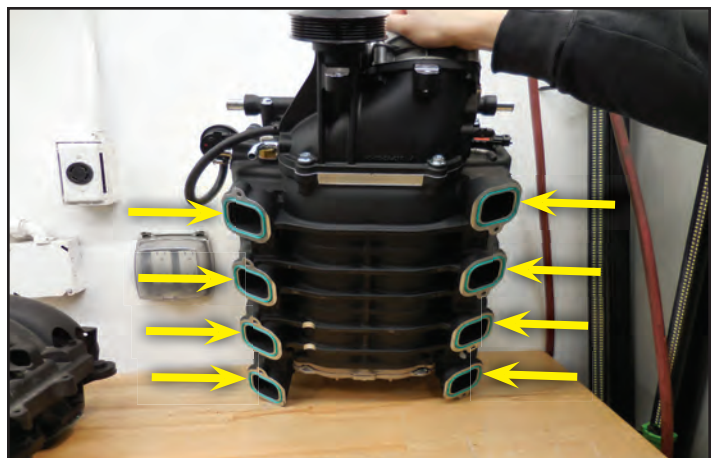

137. Vacuum out any debris from the engine valley cover to prepare for the installation of the supercharger.



138. Remove the tape that you applied to the intake ports on the heads. Ensure that the sealing surfaces are clean prior to installing the supercharger. Be careful not to get anything inside the intake ports. Inspect the ports to make sure that no debris has entered. Clean out as necessary.



139. Wipe down the intake port outer sealing surfaces with a rag coated with Tri-flow or equivalent lubricant. Pull the coil harnesses to the sides to make clearance for supercharger installation. Ensure that there are no tools or other items left in the valley area before you install the supercharger.

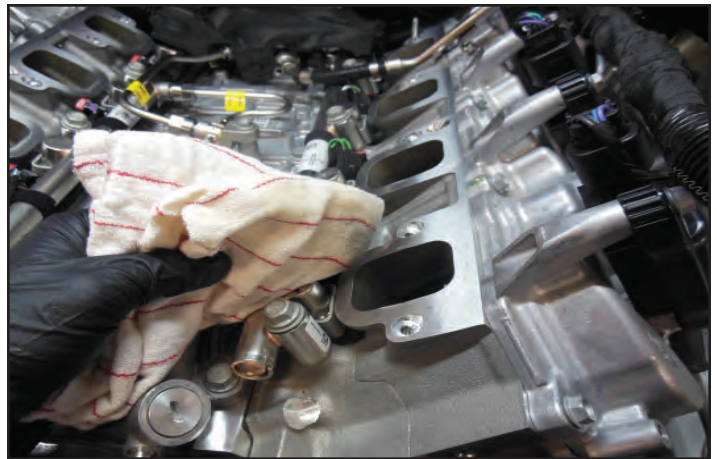

Section 8: Supercharger Installation

140. Use an engine hoist to hook the installed strap and slowly lower the supercharger in place. You should have a couple of people to help you with this process. **Be extra vigilant around the fuel line to ensure that it does not get damaged.** Start with the back end of the supercharger pointing down as shown here and gradually work it to a level orientation once it gets closer to its resting spot.



141. Remove the two bolts (shown with yellow arrows), if you haven't already done so, holding the plastic ramp that directs the electrical harness shown in the green highlighted area. Also cut the two cable ties shown with red arrows)

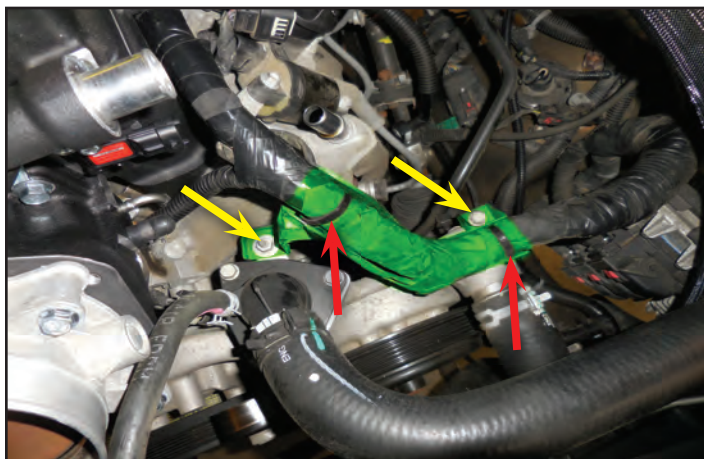

142. Remove the tape that wraps around the plastic ramp. Under this wrap is another cable tie that will need to be cut. After that the ramp shown below will be removed. This will not be reused.



143. Move the coil pack wiring harness out of the way to allow access to the mounting holes for the supercharger.



144. Gather the M6x35mm bolts and apply Loctite 242 to them as shown below. Install the driver's side front bolt first. Use a magnetic telescoping pick up tool to install the 8 supercharger mounting bolts as shown here.



145. Gather the provided universal joint 10mm socket shown.



146. Use socket from the last step with a 1/4" drive long extension to tighten the 8 bolts that were just installed. Start out by spinning these bolts in place by hand without a wrench. Follow the torque order given at the back of this manual and gradually work your way up to the **final torque of 120 in-lbs.**



147. Spin the supercharger pulley by hand after torquing it in place to ensure nothing is binding.



148. Remove the four supercharger lid bolts that are holding the two metal brackets that are securing the lift strap using a 12mm socket wrench. The 4 bolts will be reinstalled in the next step. **Save the strap and brackets in case you ever need to remove the supercharger.**



149. Apply Loctite 242 to the 4 lid bolts from the last step. Reinstall the bolts in their original location and **torque them to 18ft-lbs.**



150. Install the provided 1" slit loom to the coil pack electrical harness at the green highlighted area at the driver's side rear corner of the supercharger. Allow the coil break outs to exit through the slit.



151. Reinstall the two rear coil packs on each side in their original locations. Make sure to plug in the spark plug wire at the bottom and the electrical connection at the top. Secure each coil pack with the two OEM bolts.



152. Reinstall the coil covers on both sides.



153. Gather the provided parts shown here.



154. Insert the 90° fitting into the hose end and orient as shown.



155. Use Oetiker pliers to install the stepless ear clamp in the location shown with the tab parallel to the fitting.

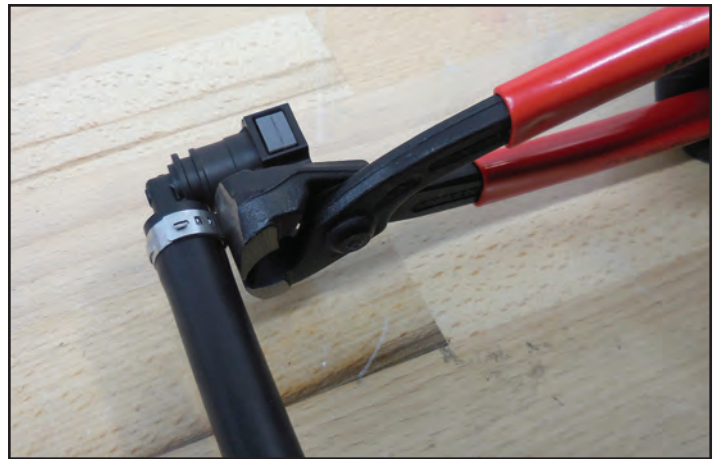

156. Pre-install the spring clamp in the location shown.



157. Install the connector from the hose assembly in the last step onto the PCV valve. You should hear a click to indicate the connector is locked. Pull up to make sure the lock is engaged.



158. Install the other end of the hose from the last step on the 90° hose barb shown and secure with the spring clamp. **The hose barb at this location might also be straight.**

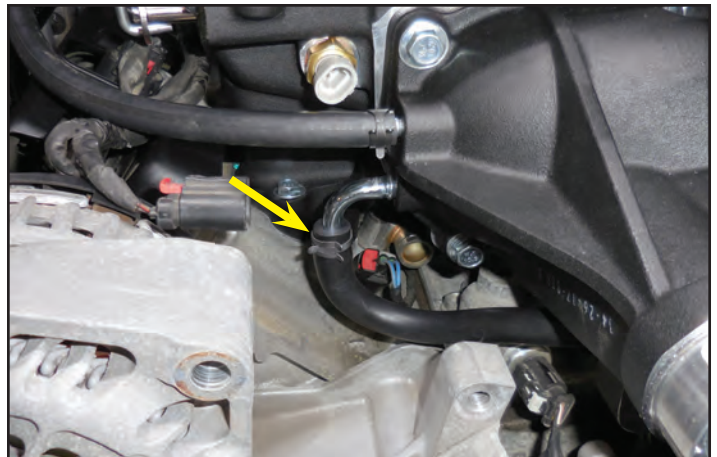

159. Plug in the MAP sensor connection and engage the locking tab shown with the arrow.

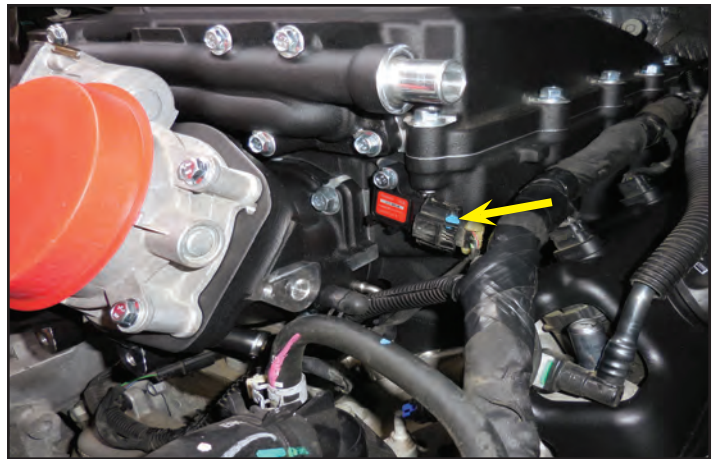

160. Gather the OEM EVAP solenoid and supplied M6x25mm bolt. Inspect the O-ring to ensure that it is not damaged. Replace if necessary. Ensure that the O-ring is clean and apply a light coat of Lubriplate grease to it before installing.



161. Install the EVAP solenoid in the location shown and secure it with the M6x25mm bolt at the yellow arrow. Plug in the electrical connection at the red arrow and the hose connection at the blue arrow.

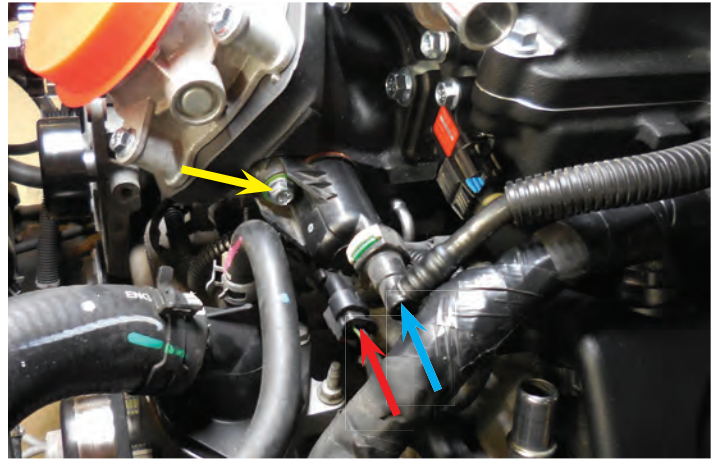

Section 9: Idler Bracket, Belt Installation and Wiring

162. Rotate the alternator back to its original position and install the provided M10x90mm button head bolt at the arrow location.

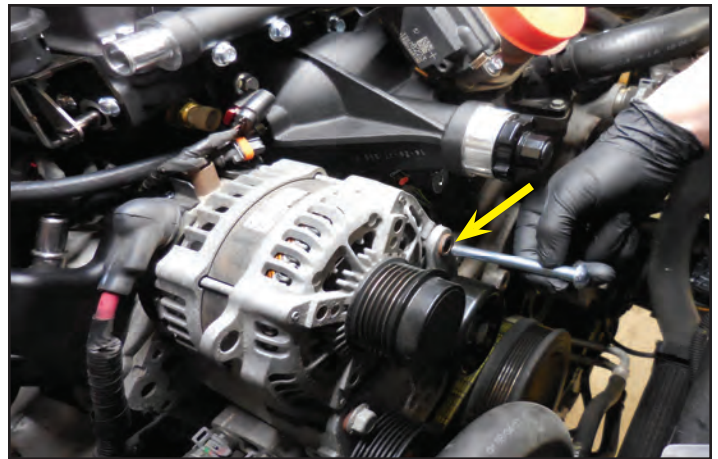

163. **Torque the two alternator bolts shown with arrows to 25 ft-lbs.**

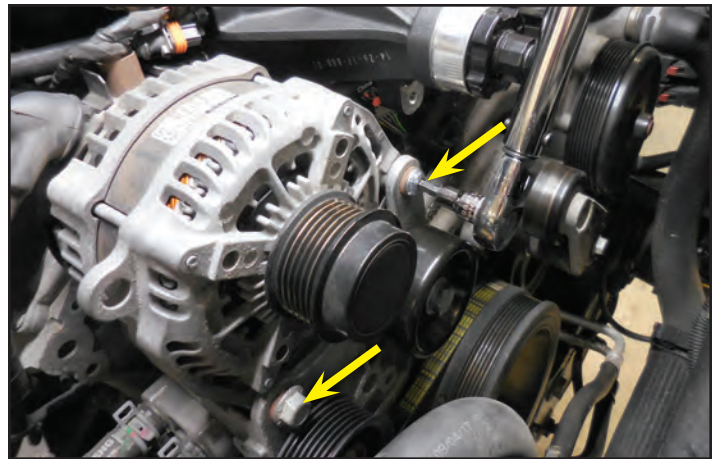

164. Gather the provided bracket and bolts. Apply Loctite 242 to the bolts as shown.

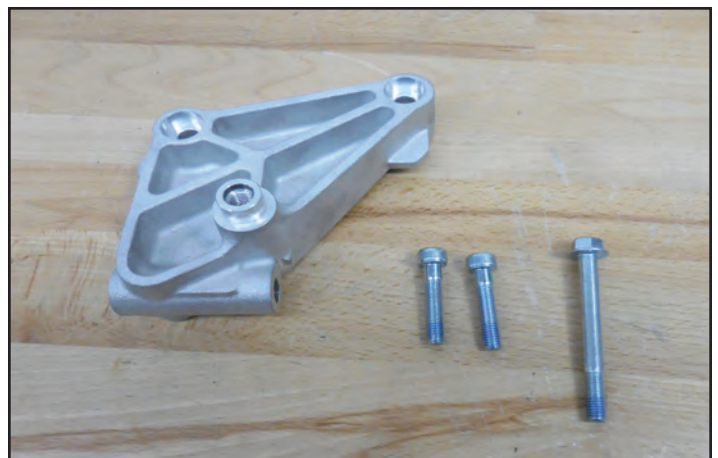

165. Install the two smaller bolts in the yellow arrow locations lightly and then lightly tighten the longer bolt in the red arrow location.

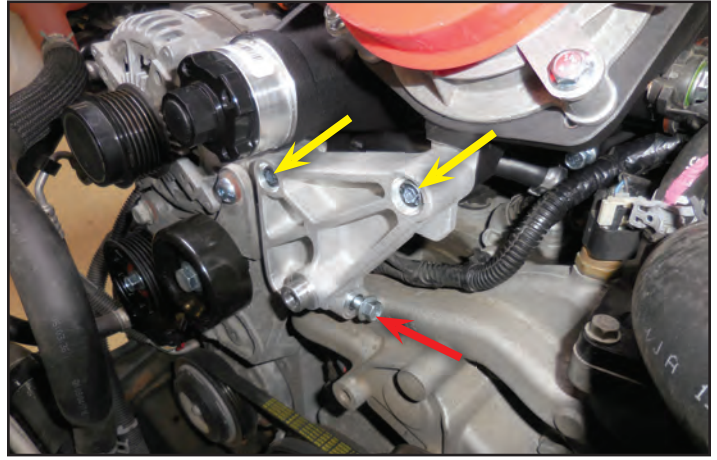

166. Once you have all the bolts seated you can **torque the two smaller bolts to 18 ft-lbs**. Finally **torque the longer bolt to 18 ft-lbs** as well.



167. Gather the provided smooth idler and M10x30mm bolt shown and apply Loctite 242 to the bolt.



168. Install the pulley from the last step into the idler bracket from two steps ago and **torque it to 25 ft-lbs** using a 15mm socket wrench.



169. Use a strap wrench to hold the supercharger pulley in place while you **torque it to 108 in-lbs** using a 10mm socket wrench.



170. Install the belt following the diagram at the back of this manual. The last pulley to place the belt over should be the smooth pulley that was installed two steps ago shown with the arrow here. Rotate the belt tensioner counterclockwise as you did while removing the OEM belt and install the belt over the pulley shown with the arrow.

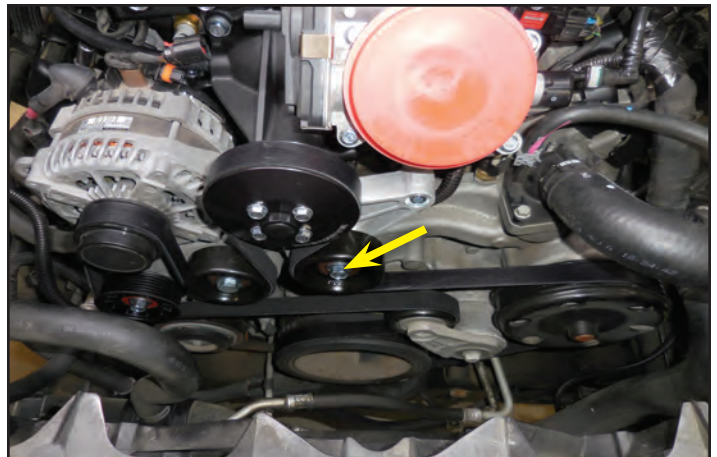

171. Plug the alternator back in.



172. Plug in the provided electronic throttle control (ETC) extension wire and secure with the locking mechanism.



173. Plug the ETC wire extension from the last step into the throttle body and secure with the locking mechanism.

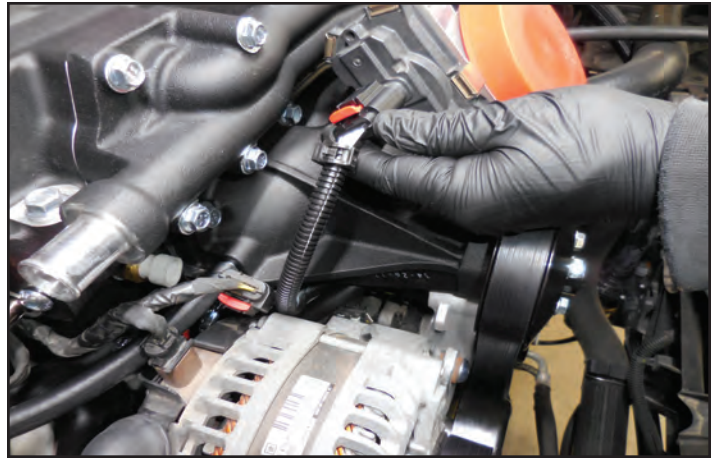

174. Tuck the excess cable under the supercharger drive cover in the arrow location. Ensure that this wire does not get into the belt path.



175. Cut the inner tabs out of the inside of the provided hose clip for the cable tie as shown in the photo below. Install the hose clip (highlighted in green) as shown in the image to the right with a cable tie (highlighted in red).



176. The alternator electrical connection is shown disconnected to allow you to see the final placement of the hose clip from the last step. Trim the excess cable tie once the location is complete. Ensure that the alternator connection is plugged in after you are done. This cable tie should keep the harness away from the supercharger bypass actuator.



177. Reinstall the air box assembly into the three grommets at the bottom. **Ensure that the air filter is clean.** Replace if necessary.



178. Gather the provided MAF/IAT breakout wiring harness shown.



179. Plug in the MAF/IAT wiring harness from the last step into the MAF sensor at the arrow location and engage the locking mechanism.



180. Connect the male plug from the MAF/IAT breakout harness to the vehicles female electrical connection and engage the locking mechanism.



181. Remove the cable tie fastener from the arrow location and cut it free from the wiring.



182. Insert the provided cable tie fastener into the location from the last step.



183. Route the factory wiring harness from the MAF sensor in the orientation shown highlighted in green. Secure in place with the two cable ties shown with arrows.

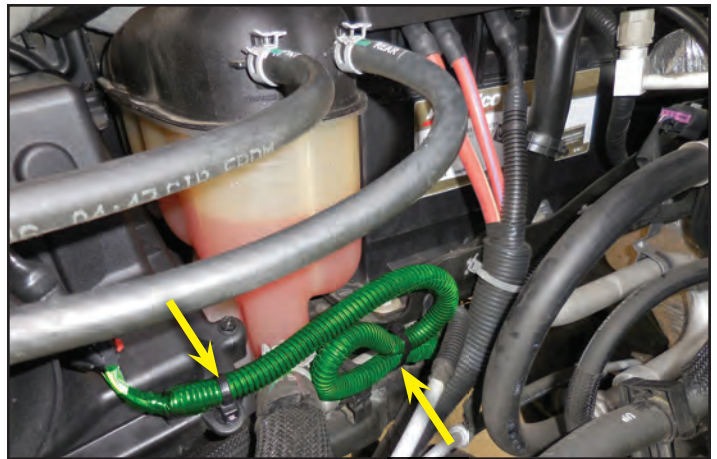

184. Plug in the MAF/IAT breakout harness at the IAT sensor located on the supercharger. Route the wire behind the alternator as shown.



185. Route the IAT wire as shown highlighted in green. Place cable ties at arrow locations.

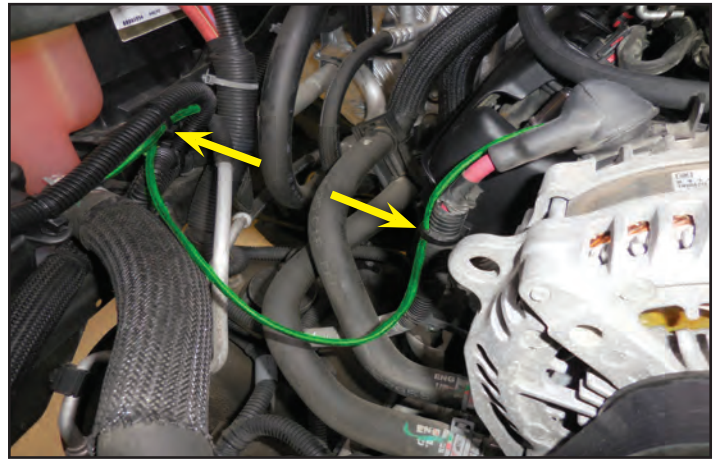

Section 10: Intercooler Hose and Inlet Air Tube Installation

186. Gather the provided formed hoses and clamps shown and install the provided mesh over the hoses. The lengths are indicated in the image.

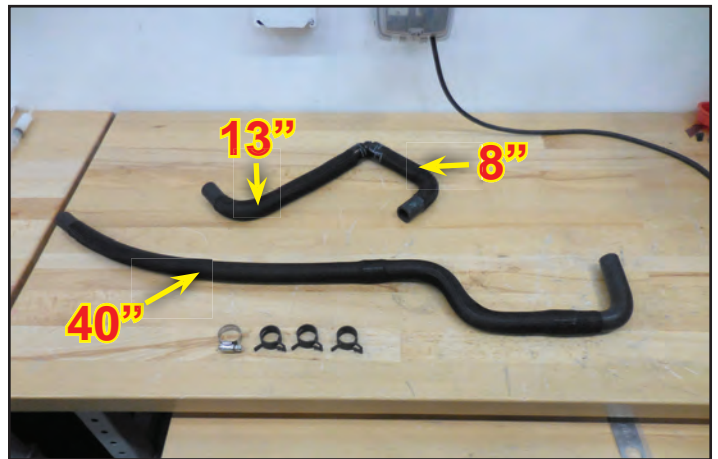

187. Pre-install one of the spring clamps at the upper LTR hose barb.

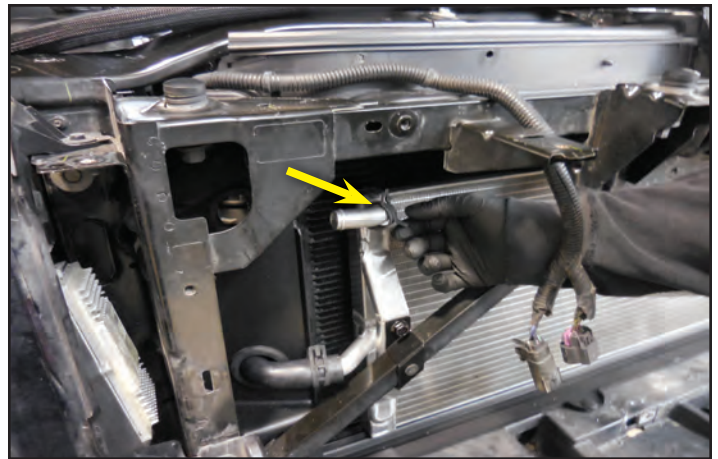

188. Route the longer molded hose from the last step through the upper hole that was made near the radiator as shown below. Once the hose has passed through the hole, route it in the orientation shown highlighted in green in the image to the right.



189. Route the hose from the last step under the air box tube as shown highlighted in green.



190. Slide the upper LTR hose onto the barb and secure in place with the pre-installed clamp at the arrow location.

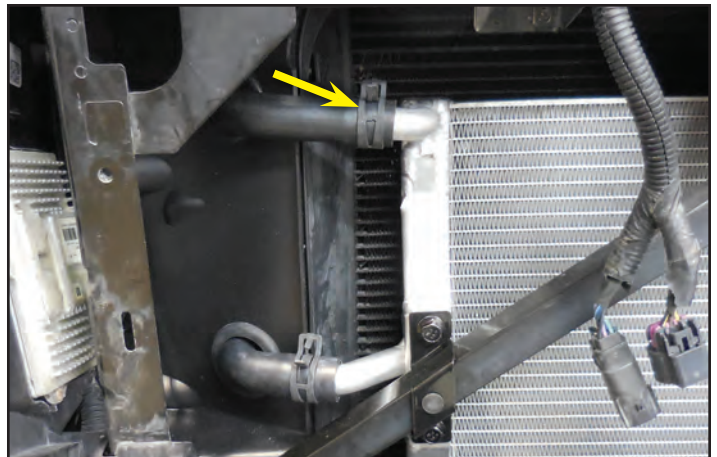

191. Connect the other end of the hose from the last step to the passenger side charge air cooler hose barb on the supercharger with a spring clamp. Face the tabs towards the rear as shown.



192. Lightly install another cable tie with a C-clip over the hose from the last step and clip it to the MAF/IAT breakout harness as shown highlighted in green. **The cable tie should be snug on the hose so it does not restrict coolant flow.**

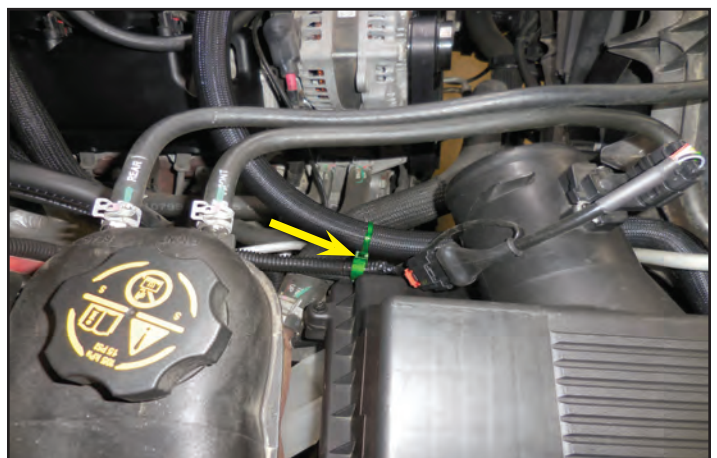

193. Install the provided hose assembly shown onto the driver's side charge air cooler location and secure with a spring clamp. Attach the other end at the back of the reservoir and secure with a worm gear clamp. **You must use the worm gear clamp at the back of the reservoir to avoid leaks.**



194. Install the provided swivel clamp (highlighted in green) between the hose from the last step and the adjacent electrical harness.



195. Gather the intake tube assembly and adapter shown. (Note: Adapter may be preinstalled in tube and will need to be removed as shown)



196. If you are using the stock 6.2L throttle body you will need to install the adapter shown. There is a lip on the inside diameter that faces out. The lip is also tapered on the outside.



197. Install the intake tube between the airbox and the throttle body. Passenger side barb should point straight backwards.



198. Tighten the two hose clamps at both sides of the intake air tube using a 7mm nut driver.

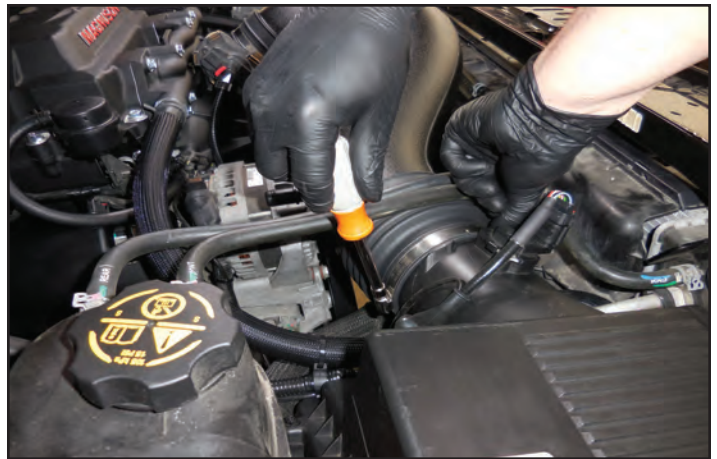

199. Gather the hose clamps, fittings, mesh and hose shown. Cut the 5/8" hose to 7" and install the 6" mesh over it.

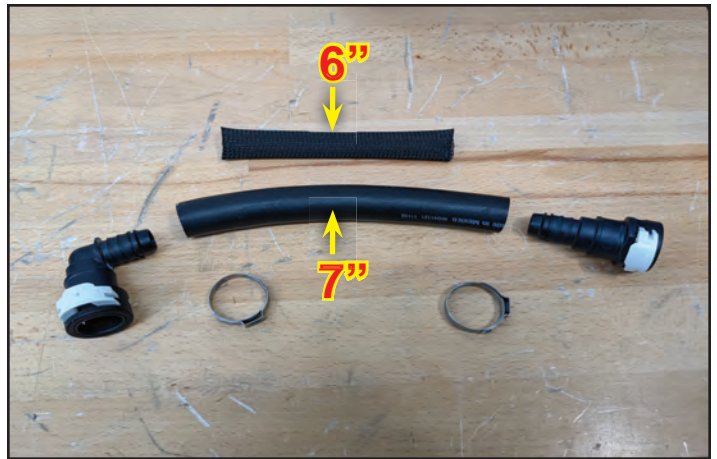

200. Pre-install the two hose clamps, followed by the two fittings. Next use Oetiker clamp pliers to secure the two clamps as shown.



201. Install the 90° fitting of the hose assembly from the last step onto the passenger side valve cover and press the white locking button. Connect the straight fitting from the hose assembly in the last step onto the inlet air tube where shown and press the white locking button. Pull at each connection to make sure the locks are engaged.



202. Gather the provided polyester mesh, hose clamps, fittings and 5/8" diameter hose. Cut the hose to 17 inch long. Install the provided 17 inch mesh over the hose.



203. Pre-install the two hose clamps, followed by the two fittings. Next use Oetiker clamp pliers to secure the two clamps as shown.



204. Install the hose from the last step between the driver's side valve cover and the inlet air tube. Ensure that you press the two white locking buttons. Pull at each connection to make sure locks are engaged.



Section 11: Coolant Fill and Final Testing

205. It is highly recommended that you use a vacuum tool to bleed your coolant system. Follow the manufacture's directions for performing the bleeding process. Ensure that you use the same coolant mixture recommended by GM for the engine coolant in your intercooler system.



206. Re-connect the battery negative terminal using a 10mm socket wrench.



Make sure that you have followed step #1 in this manual to load the proper supercharger calibration to your vehicle's ECM.



207. Alternatively you can pour approximately 1 gallon of coolant into the reservoir filling the system, and then cycle the pump by turning on the ignition briefly (**Do Not Start The Engine**). It helps to have someone else turn on the ignition while you monitor the level. **Make sure you don't let the coolant mixture get too low because it will cause air to be added to the system.** Continue to fill and cycle the pump briefly until the system is full. Allow about an inch of space from the top of the reservoir for coolant expansion.



208. After you have filled your intercooler system, and verified the connections are leak free, reinstall fascia, and grille following steps shown in Section 3 and Section 2 in reverse order.



209. Start the vehicle for 5 seconds and shut off, once again check for fuel leaks and supercharger belt alignment. **Ensure that the engine is cool** before you check the radiator level and charge air cooler reservoir and top off as necessary.



210. Test drive vehicle for the first few miles under normal driving conditions. **Do not perform any wide open throttle runs.** Listen for any noises, vibrations, engine misfire or anything that does not seem normal. The supercharger does have a slight whining noise under boost conditions, which is normal. Check & bleed the charge air cooler reservoir as needed.



211. After the initial test drive gradually work the vehicle to wide open throttle runs, listen for any engine detonation (pinging). If engine detonation is present let up on the throttle immediately. Most detonation is caused by low octane gasoline still in the tank. Affix the Premium Fuel Only decal on the inside of the fuel fill door.

If you have questions about your vehicles performance, please check with your installation facility.

After you finish your installation and road test your vehicle, please fill out the warranty registration. This can be found on our website.



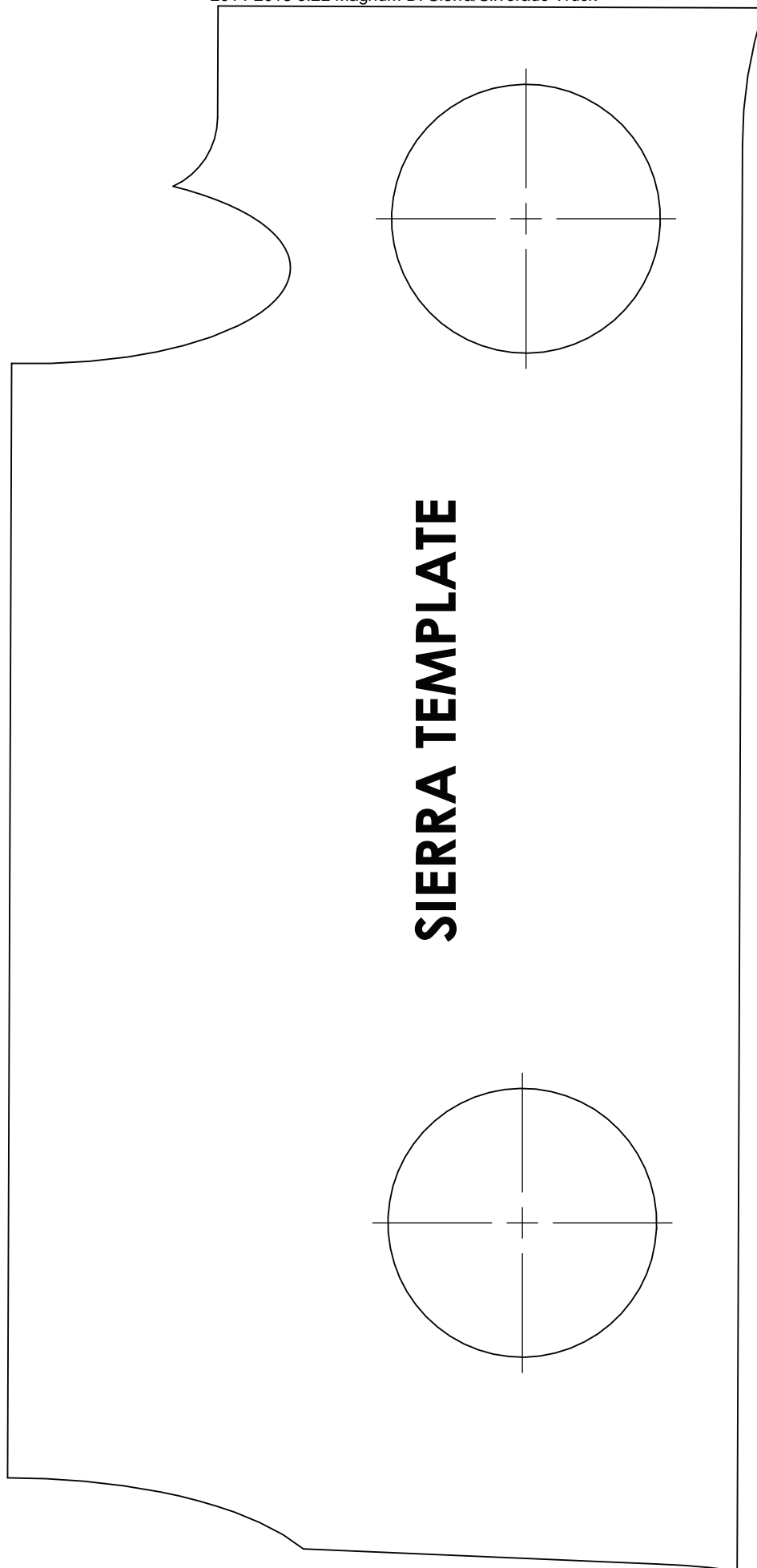

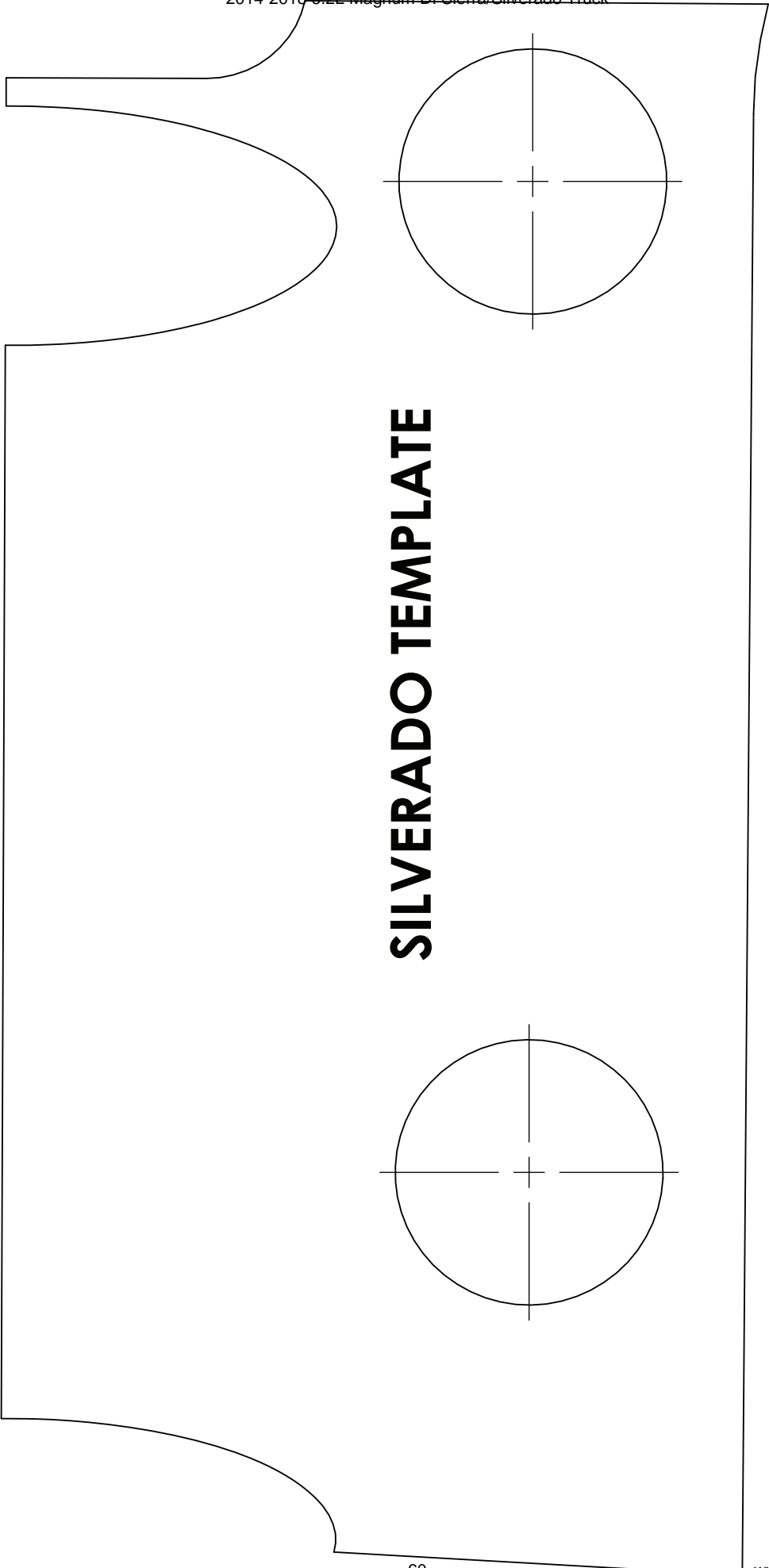

Belt Routing Diagram

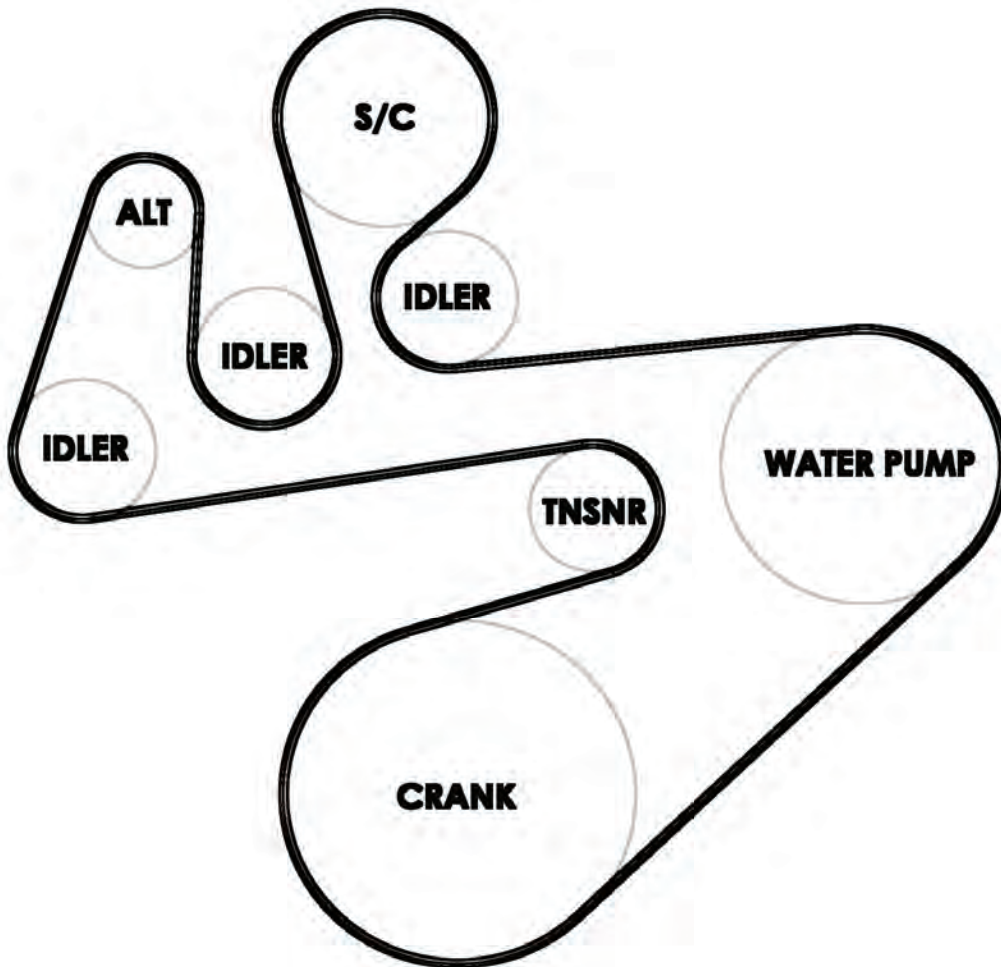

2014-2018 Magnum Truck Torque Sequence

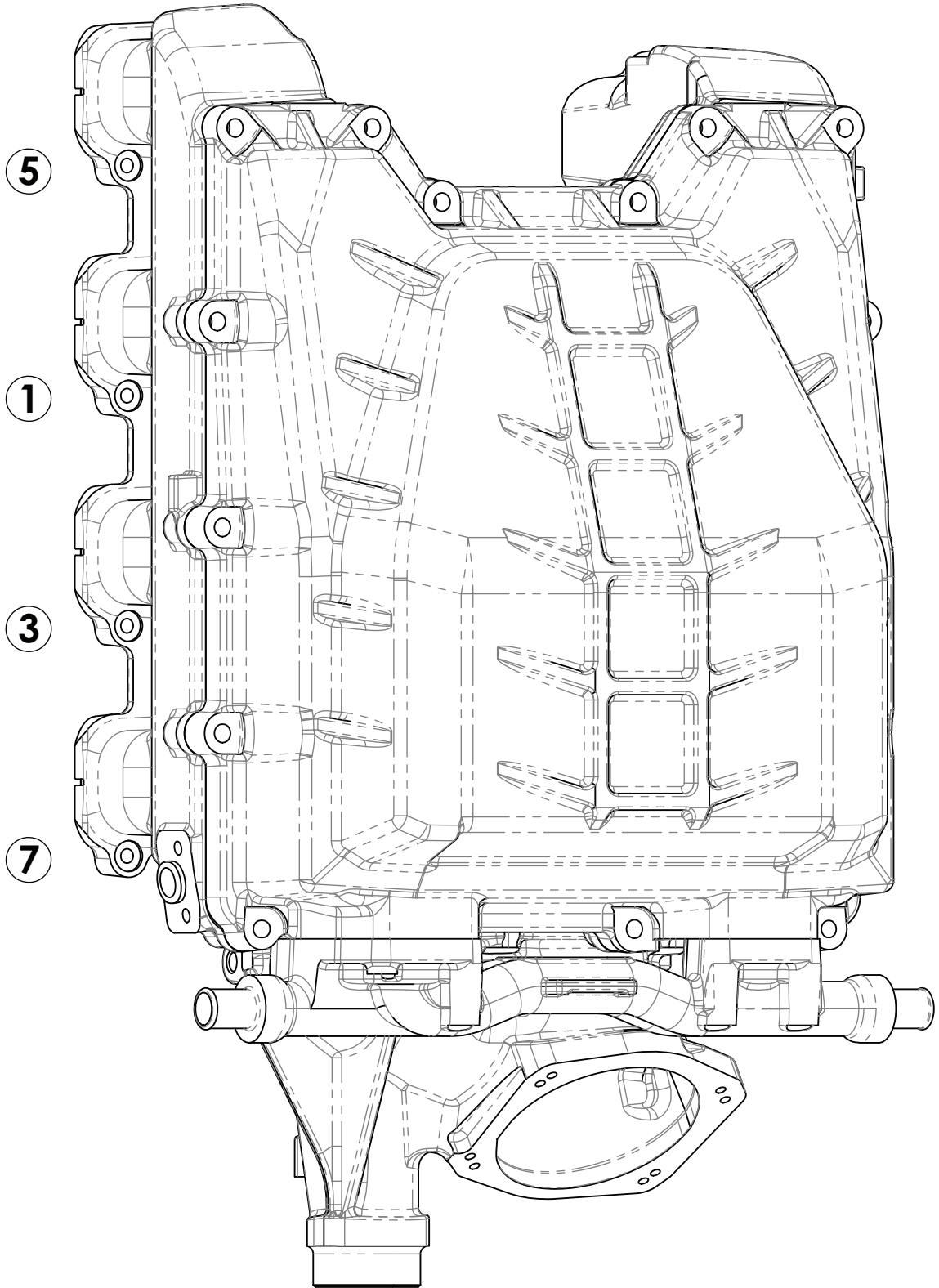

2014-2018 Magnum Truck Torque Sequence

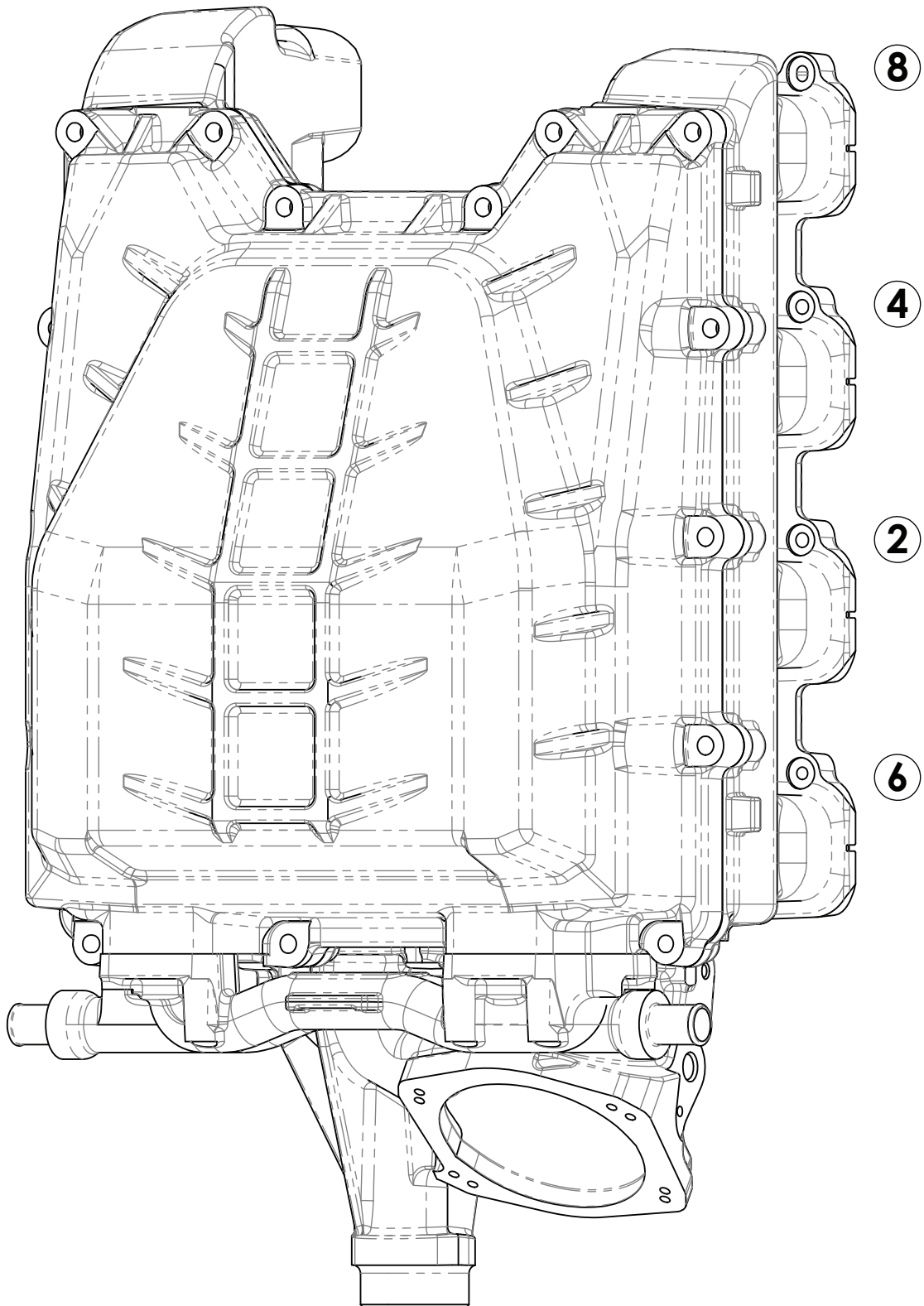



If you have questions about your vehicles performance, please check with your installation facility.

This supercharger system requires the use of only premium gasoline fuel, 91 octane or better. It is NOT compatible with E85, Ethanol, Flex Fuels.

NOTE: Your supercharger system is sensitive to corrosion. You must use the GM specified coolant mixture in the intercooler system as well as your radiator.

Please enjoy your "Magna Charged"
performance responsibly!

MAGNUSON
SUPERCHARGERS