

# MAGNUSON

## SUPERCHARGERS

Installation Instructions for:  
2017-2022 Chevy Colorado Supercharger Kit



**\* PREMIUM GASOLINE FUEL REQUIRED \***

**WARNING: DO NOT BEGIN THE INSTALLATION BEFORE OBTAINING YOUR NEW CALIBRATION FILE. IN SOME CASES, ESPECIALLY WITH NEWER VEHICLES, THIS STEP CAN TAKE SEVERAL DAYS AND YOUR VEHICLE WILL BE IMMOBILIZED WHILE YOU WAIT FOR THE NEW CALIBRATION FILE.**



**ATTENTION!**  
Your **MAGNUSON SUPERCHARGER** kit is sensitive to corrosion!  
Use **only** the vehicle manufacturer recommended coolant for your engine in the intercooler system as well.

Magnuson Superchargers  
1990 Knoll Drive, Bldg A, Ventura, CA 93003  
(805) 642-8833 phone  
[magnusonsuperchargers.com](http://magnusonsuperchargers.com)

# INSTALLATION MANUAL

## Magnuson Supercharger Kit: 2017-2022 Chevy Colorado 3.6L

Please take a few moments to review this manual thoroughly before you begin work: Make a quick parts check to be certain your kit is complete (see Bill of Material (BOM) parts list inside the accessory box). If you discover shipping damage or shortage, please call our office immediately. Take a look at exactly what you are going to need in terms of tools, time, and experience. Review our limited warranty with care.

**Use only premium gasoline fuel, 91 octane or better.**

Magnuson Superchargers recommend that you run a minimum of one (1) tank of premium fuel through your vehicle prior to installation of the system to prevent any possible damage that may occur due to running the supercharged engine on lower octane fuel.

Magnuson Supercharger systems are designed for engines and vehicles in "GOOD" mechanical condition. Magnuson Superchargers recommend that a basic engine system "Health Check" be performed prior to the installation of this supercharger system. Be sure to check for any pending or actual OBDII codes and fix/repair any of the stock systems/components causing these codes. If there are codes prior to the installation they will be there after the installation.

Magnuson Superchargers also recommend the following services to be performed on your vehicle before starting and running the vehicle post supercharger system installation:

- Fuel Filter change
- Engine oil and filter change using brand name oil (organic or synthetic) and filter

Note: It is VERY IMPORTANT to use the factory specified oil viscosity. The original equipment manufacturer has selected this grade of oil to work with your other engine systems such as hydraulic chain tensioner and variable cam controls. Deviation from this specification may cause these systems to fail or not function properly. Please refer to your owner's manual for the recommended oil viscosity for your engine and application.

On older vehicles Magnuson Superchargers recommend these additional services be performed:

- Coolant system pressure test and flush. **NOTE: YOU MUST USE CHEVROLET SPECIFIED COOLANT MIXTURE!**

Non "Magnuson Approved" calibrations or "tuning" will Void ALL warranties and CARB certification.

Our supplied calibration is designed for use with the components provided in this kit. Any adjustment to the intake, or exhaust systems or other engine components may adversely affect engine performance and may trigger your check engine light.

**Magnuson Superchargers kits are designed for use on stock vehicles. To that end, the alteration or modification of the fuel system, drive train, engine, and/or supercharger outside of stock parameters in any way can result in engine damage or failure for which Magnuson Superchargers is NOT responsible and will void Magnuson Superchargers warranty and CARB certification. Aftermarket engine recalibration devices that modify fuel and spark curve (including, but not limited to programmers) are not recommended and may cause engine damage or failure. Use of non-Magnuson Superchargers approved programming will void all warranties. If you have any questions, call us.**

**Drive belt = Gates #K060605**

## **Tools Required**

**Metric wrench set**  
**Metric 3/8" and 1/2" drive metric socket set (standard & deep)**  
**3/8" and 1/2" drive ft-lbs and in-lbs torque wrenches**  
**Metric Allen socket set 3/8 drive**  
**Metric Allen wrenches**  
**Phillips and flat head screwdrivers**  
**Serpentine belt tool**  
**Funnel**  
**Drain pan**  
**Hose cutters**  
**Saw**  
**Safety glasses**  
**Nut driver**  
**Compressed air**  
**Air gun**  
**Impact gun and socket set**  
**Torx socket set 3/8 drive**  
**6 Quarts of Oil (Manufacturer's Specification) and Oil Filter**

## **Contact Information:**

**Magnuson Superchargers**  
**1990 Knoll Drive, Bldg A**  
**Ventura, CA 93003**

**Sales/Technical Support Line (805) 642-8833**  
**Websites [www.magnusonsuperchargers.com](http://www.magnusonsuperchargers.com)**  
**Email [sales@magnusonsuperchargers.com](mailto:sales@magnusonsuperchargers.com)**

# Table of Contents

Section 1: Initial Preparation	5
Section 2: Grille and Front Fascia Removal	6
Section 3: Intake Manifold Removal	8
Section 4: Continued Preparation	12
Section 5: Front End Auxiliary Drive	17
Section 6: Supercharger Intake Manifolds	22
Section 7: Supercharger Install	29
Section 8: Intercooler System Routing	34
Section 9: Final Assembly and Testing	40



**Any reference to left or right side of vehicle is given from driver's seat perspective.**

## Section 1: Initial Preparation

1. If your kit has a provided handheld tuner follow the instructions in the provided pamphlet to install your tune. **WARNING: DO NOT BEGIN THE INSTALLATION BEFORE OBTAINING YOUR NEW CALIBRATION FILE. IN SOME CASES, ESPECIALLY WITH NEWER VEHICLES, THIS STEP CAN TAKE SEVERAL DAYS AND YOUR VEHICLE WILL BE IMMOBILIZED WHILE YOU WAIT FOR THE NEW CALIBRATION FILE.**
2. Your Intercooler system is sensitive to corrosion. It's very important to use the OEM recommended coolant mixture in your supercharger system as well.
3. Your system requires the use of a minimum 91 Octane gasoline fuel. This system is **not** compatible with E85 fuel.



4. Raise hood and disconnect negative battery cable from battery. After battery cable has been removed, place a rag between the cable and the terminal to ensure they do not accidentally contact each other.



5. Remove the labeled fasteners here on the left front wheelhouse liner.

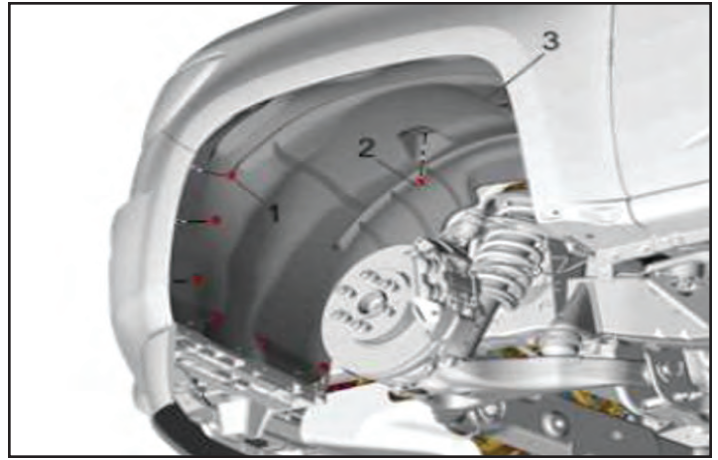

6. Remove the labeled fasteners and remove the wheelhouse liner. Repeat the procedures from this and the last step to the right hand side wheelhouse liner.

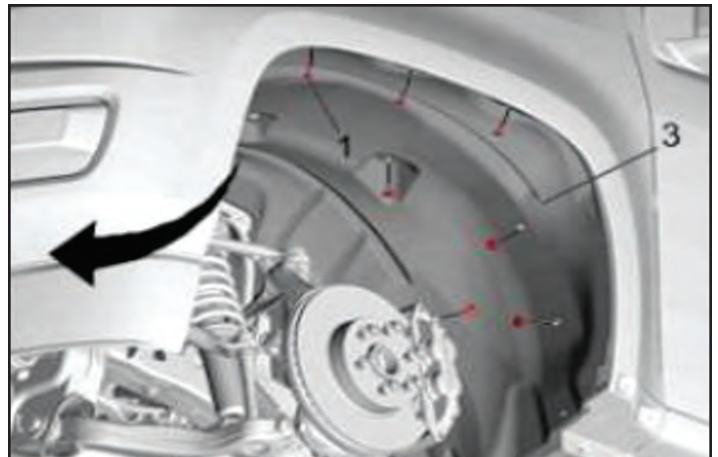

## Section 2: Grille and Front Fascia Removal

7. Remove the underbody splash shield.

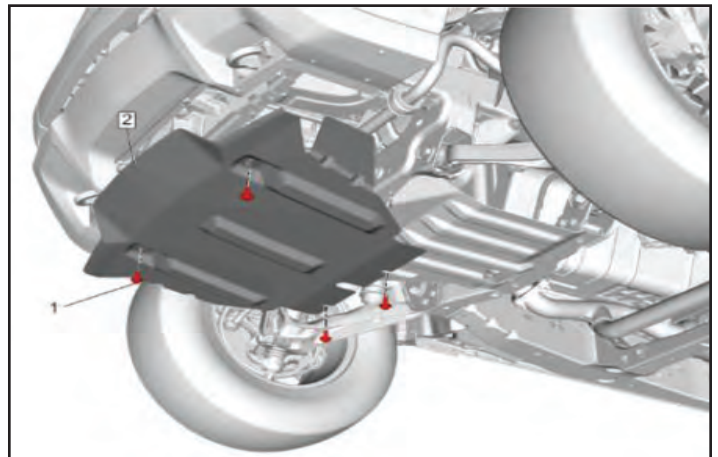

8. Remove (6) front upper grille bolts

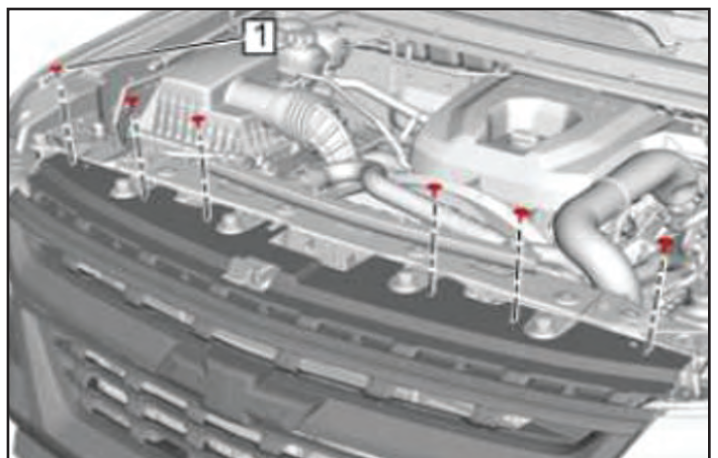



9. Remove (4) front lower grille bolts

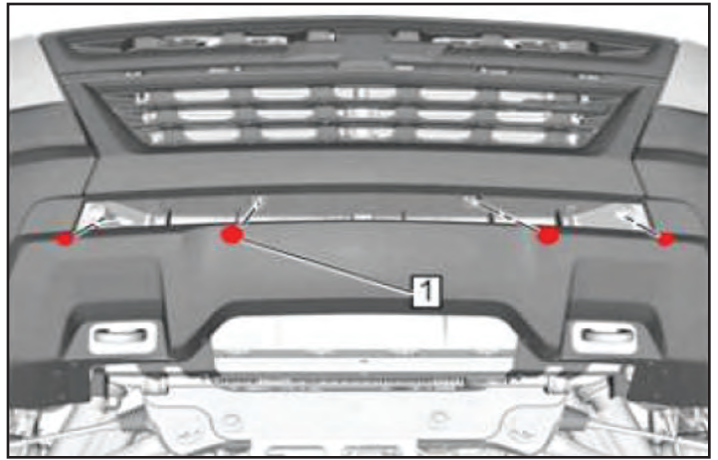

10. Remove (2) front lower fascia bolts.  
Remove (2) front bumper fascia bolts.

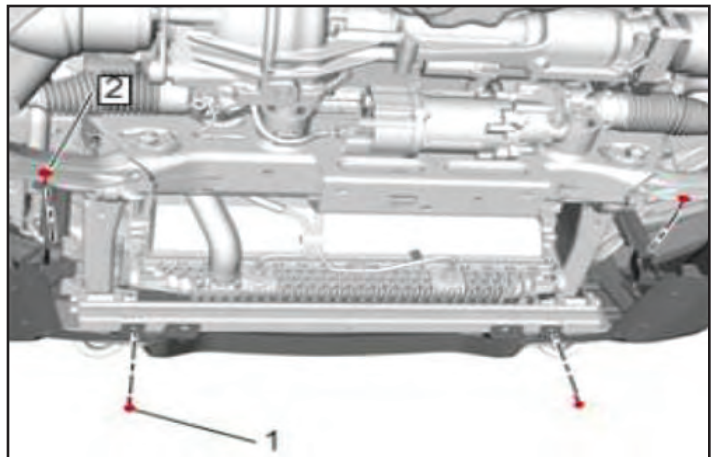

11. Remove (3) front bumper fascia to fender bolts.

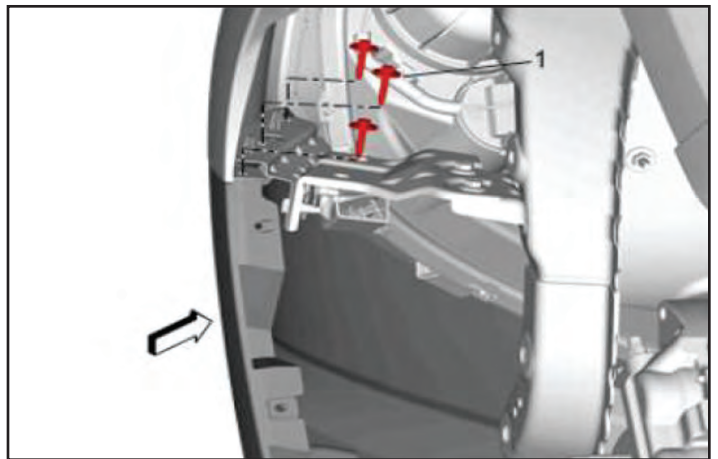

12. Pull the grill forward to disengage (1) grille retainer.

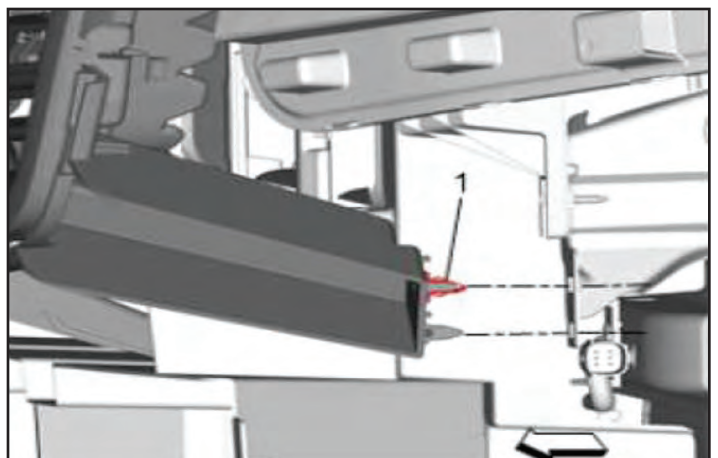

13. Place a small nylon wedge between the fascia and the fender. Insert a small flat-blade screwdriver and apply downward pressure to release the guide pins. Disconnect all electrical connectors. Carefully remove the front fascia from the vehicle. Place it on a soft, clean surface ensuring it does not scratch.



### Section 3: Intake Manifold Removal

14. Loosen (3) fasteners securing the engine cover to the engine in the locations shown. Remove oil fill cap. The oil fill cap will be reused.

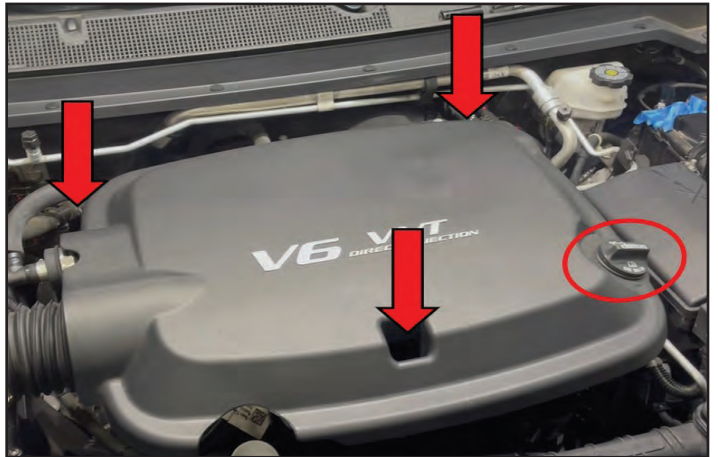

15. Loosen gear clamp at PCV fresh air tube joint. Loosen gear clamp at clean air tube joint.

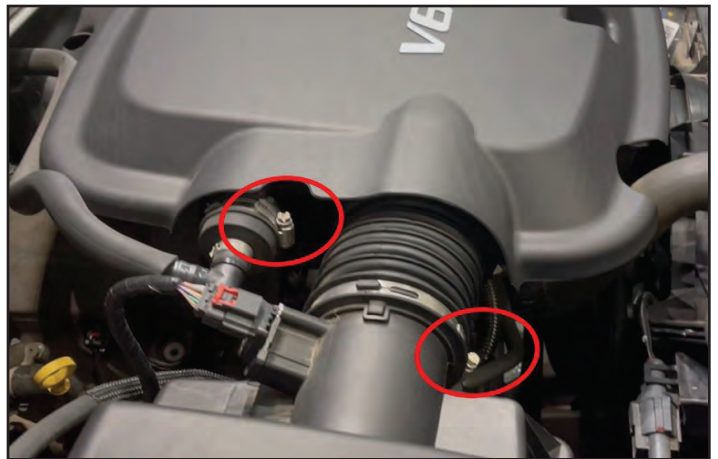

16. Loosen gear clamp at throttle body under LH side of cover.





17. Lift engine cover up slightly then disconnect PCV cross-over tube from the clean air tube.

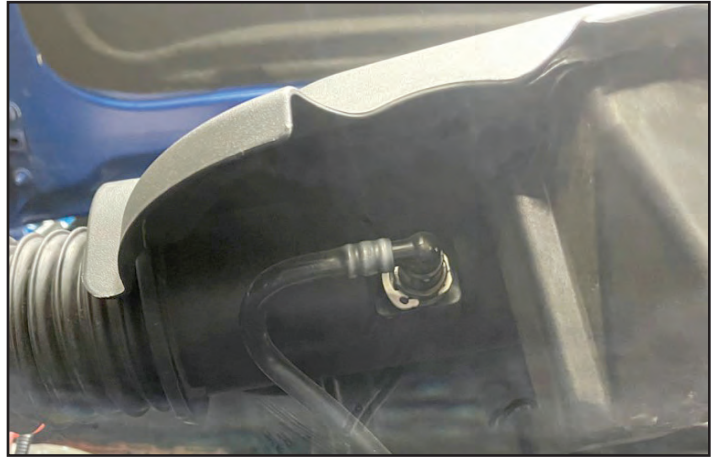

18. Remove engine cover.



19. Disconnect wiring harness connections at throttle body, MAP sensor and EVAP solenoid

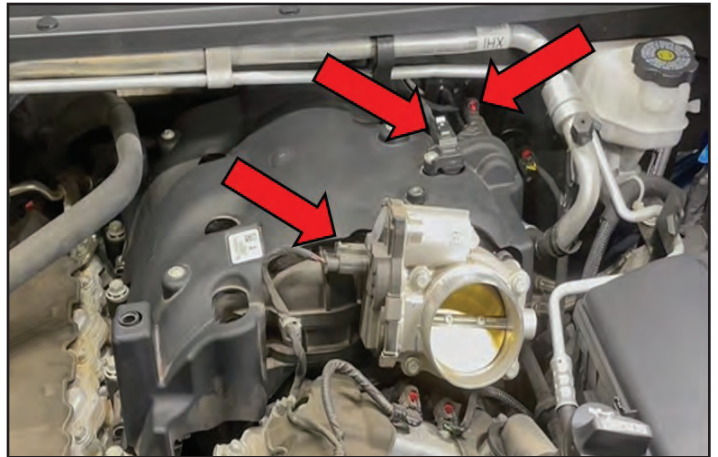

20. Remove wiring harness fir tree connector from front of intake.





21. Remove wiring harness fir tree connector from LH rear corner of intake by EVAP solenoid.



22. Remove (4) fasteners securing the throttle body to the intake manifold. Remove the throttle body and set aside. Fasteners will be re-used.

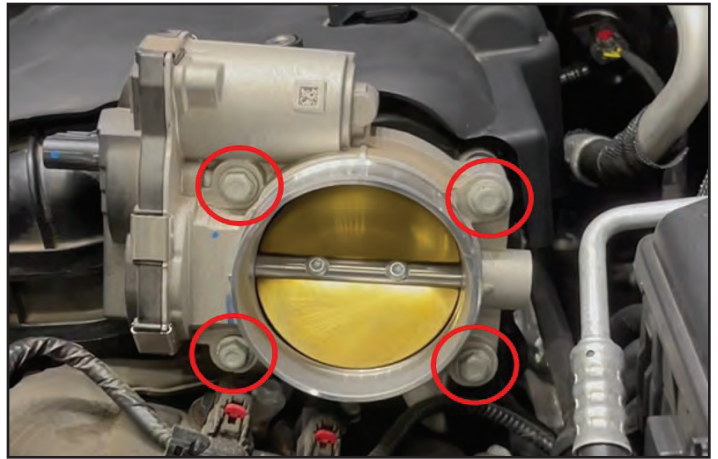

23. Disconnect the EVAP line from solenoid at the LH rear of the intake manifold.



24. Loosen fastener securing intake manifold to LH cam cover under throttle body inlet.



25. Remove fir tree connector @ RH rear corner of intake.



26. Loosen and remove (2) fasteners securing rear of intake to metal bracket. These fasteners will be re-used.



27. Loosen (8) intake bolts



28. Using a fork tool, remove the captured intake fasteners to enable the intake to be removed from the engine.





29. Slide the intake forward to gain access, then remove the brake aspirator from the connection point at the rear. Remove the intake from the vehicle.



**It is VERY important to not contaminate your work environment or allow any debris to fall into the exposed ports, or engine damage can occur.**

30. Vacuum around all intake ports to remove any debris.



31. Tape off all intake ports.



#### Section 4: Continued Preparation

32. Remove fir tree connector from AIS support bracket.



33. Remove (2) fasteners securing the AIS bracket to the engine. Set bracket aside. Re-install the bolt on the vehicles right (passenger) side shown circled in yellow. **Torque to 19.5 ft-lbs.**

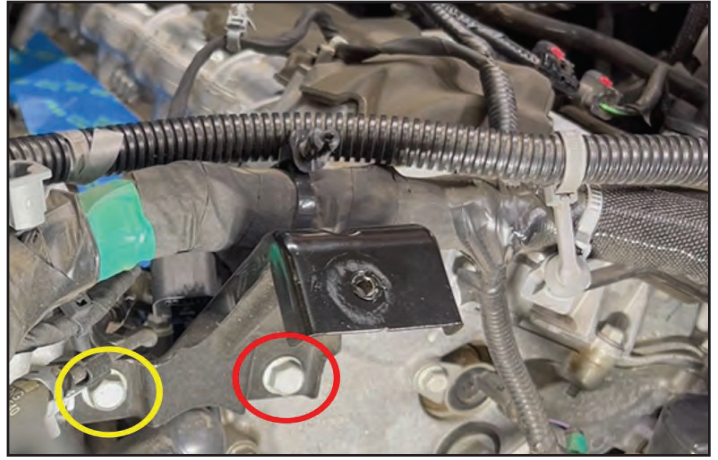

34. Remove (1) fir tree connector securing the battery cable to the oil fill tube bracket.



35. Remove (2) fir tree connectors securing the main harness bundle to the oil fill tube bracket.



36. Remove (2) oil fill tube bolts securing the tube to the LH cam cover.

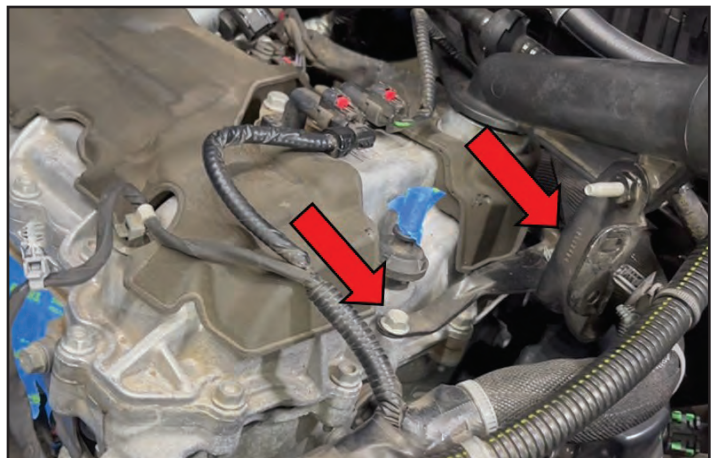



37. Remove fastener securing the oil fill tube to the bracket. Remove the oil fill tube bracket from the engine and set aside.



38. Roll up several paper towels and stuff them down the oil fill tube until they have reached the bend in the tube by the cam cover shown with an arrow. Tape off the PCV connector in the front of the LH cam cover to ensure debris does not enter the engine.



39. Using a saw, cut the oil fill tube at the straight section by the cam cover as shown in the photo to the right and below.



40. Rotate the remaining piece of the oil fill tube out of the LH cam cover then re-install the factory oil fill cap as shown below. Vacuum the area to remove any debris generated during the cutting operation.





41. Remove hardshell connector secured to bracket at front of engine by vacuum pump.

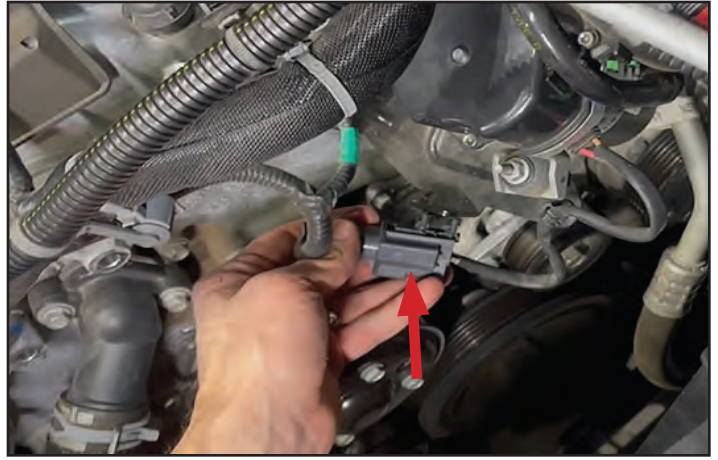

42. Disconnect LH cam sensor hardshell connector at front of engine.



43. Disconnect vacuum pump hardshell connector.

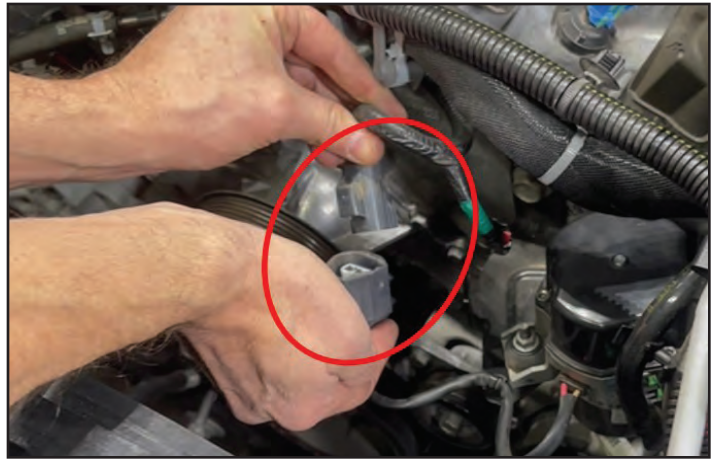

44. Remove vacuum pump fir tree connection to the pump bracket.



45. Cycle the green lock and disconnect the vacuum line at the pump.



46. Remove (2) fasteners securing the vacuum pump to bracket. Fasteners will be re-used.



47. Loosen and remove 18mm fastener holding air pump bracket to front cover shown in photo to the left and at the arrow location below.

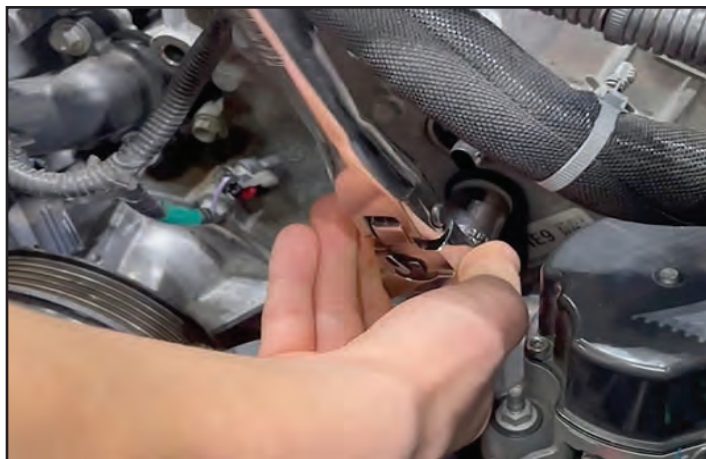

48. Loosen and remove 13mm fastener securing air pump bracket to the top left corner of the front cover. Take care not to lose the J-Clip nut (shown below) on the backside of the fastener. Fastener and J-Clip nut will be re-used.





49. Remove the air pump bracket from the engine.



### Section 5: Front End Auxiliary Drive

50. Working from underneath the vehicle, remove the skid plate (if equipped) by removing (4) 15mm fasteners.

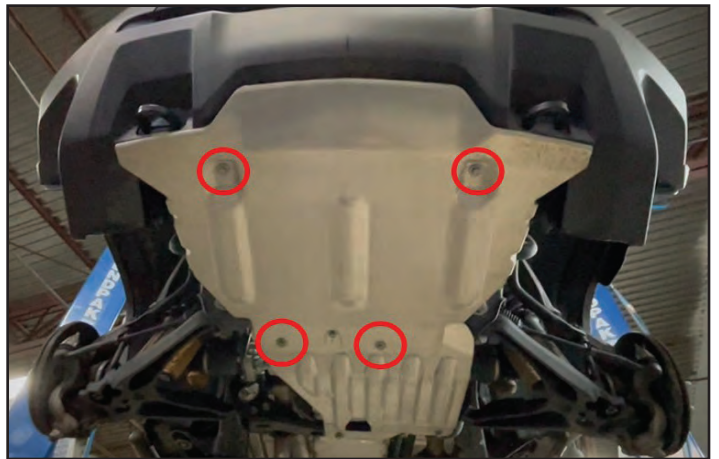

51. Disconnect the electric fan harness connection on the RH side of the fan shroud.

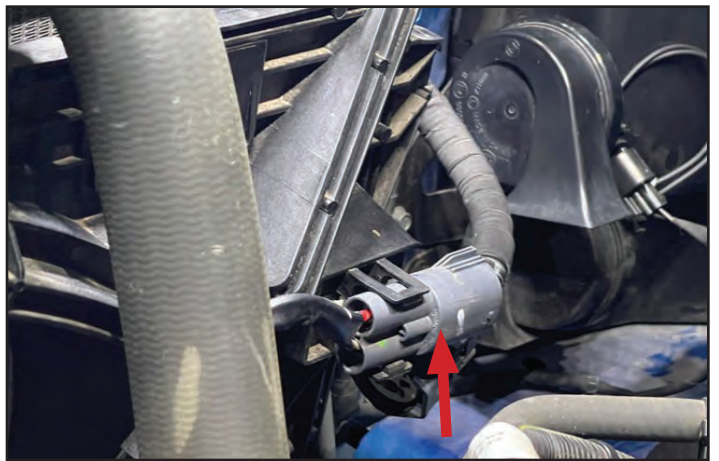

**Ensure that the engine is cool before you attempt to drain any coolant. Wear safety goggles to protect your eyes.**

52. Place a clean drain pan below the radiator. Drain coolant from the radiator petcock at the bottom of the radiator.

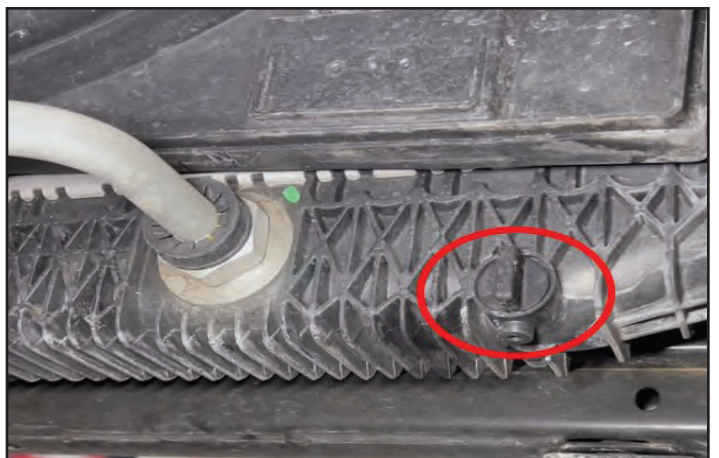

53. Remove the upper radiator hose.



54. Remove (2) fasteners securing the fan shroud to the radiator (RH side shown, LH side similar).

Lift the fan shroud assembly out from the vehicle and set it aside.



55. Remove the factory damper bolt from the engine with an impact gun.



56. Select the supercharger drive pulley. Verify the dowel pin has been installed and protrudes toward the rear of the pulley as shown in the photo below.

Apply a bead of RTV to the front AND rear of the pulley in the locations shown. Add a third bead to the front of the washer as shown.

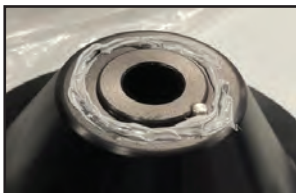



57. Orient and install the supercharger drive pulley onto the front of the factory damper.

**IMPORTANT: ensure the drive pin in the back of the pulley engages into the key-way on the front of the factory damper.**

Install the new 24mm bolt provided in the kit.

You can use the bolt to help seat the supercharger pulley into the damper bore but **ONLY** with a hand ratchet. Run the bolt down and zero torque it, ensuring the pulley and pin remain aligned, and the pulley has engaged fully into the damper bore before proceeding further.

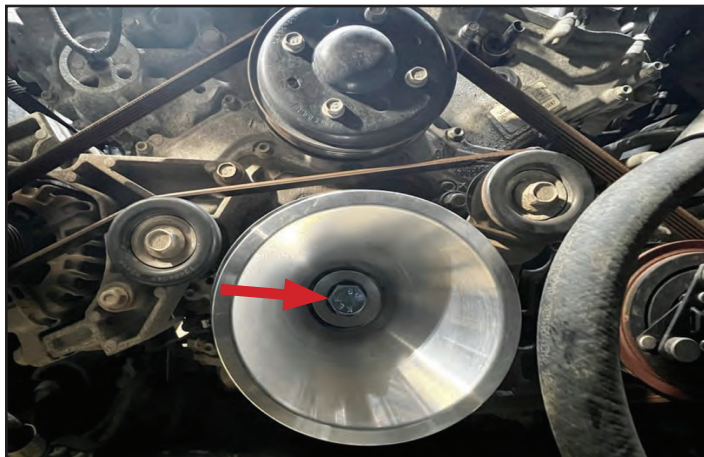

58. **IMPORTANT: inspect the gap between the back of the supercharger pulley and the front of the factory damper before you final torque the bolt. The gap between both pulleys MUST be uniform around the entire circumference. If it is not, the pulley is not seated correctly.**

The following slide details the method for holding the crankshaft while torquing the new damper bolt.



59. The transmission inspection plug can be removed to gain access to the torque converter lugs on the front side of the flexplate as shown.

With the aid of a helper, remove the inspection plug, rotate the crankshaft to a suitable place and use a large screwdriver or prybar against one of the lugs to hold the crankshaft stationary while you **torque the damper fastener to 190 ft-lbs.**

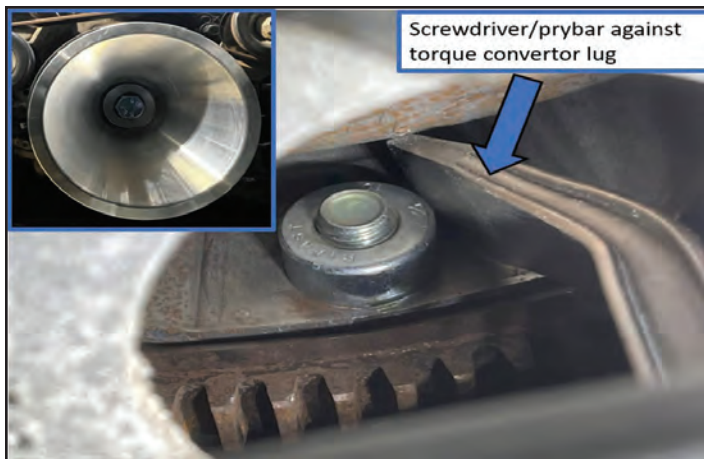

60. Remove the circled 10mm fastener, this will be re-used in next step.

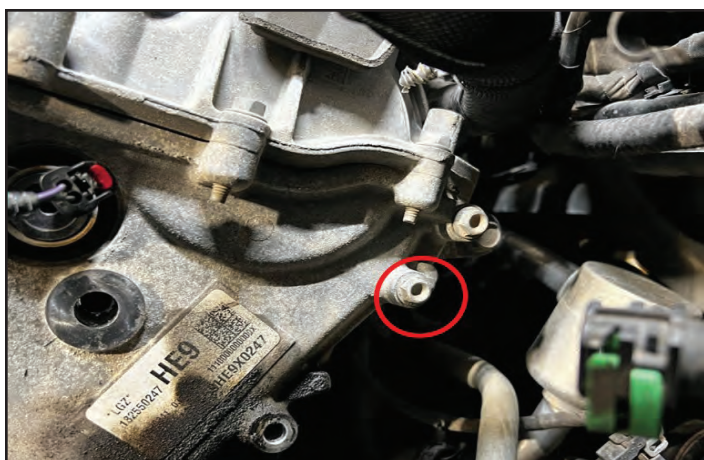



61. Install the new vacuum pump bracket, re-use the two factory fasteners and J-nut removed earlier.

**Torque the 10mm hex fastener to 96 in-lbs.  
Torque the 13mm hex fastener to 19.5 ft-lbs.**

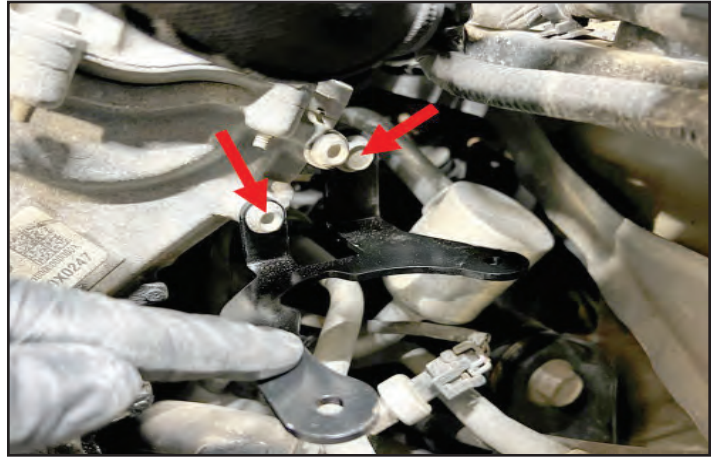

62. Install pump on the bracket, re-using the factory fasteners. Tighten until 1/2" length of fastener is exposed past the nut.



63. Install the three 50mm long spacers, stepped end first, into the supercharger idler bracket in the locations shown. Use a light press or rubber mallet to fully seat spacers.

Install x1 the M10 x 25mm long, hand tight only, in the location shown. A bracket will locate this position later.

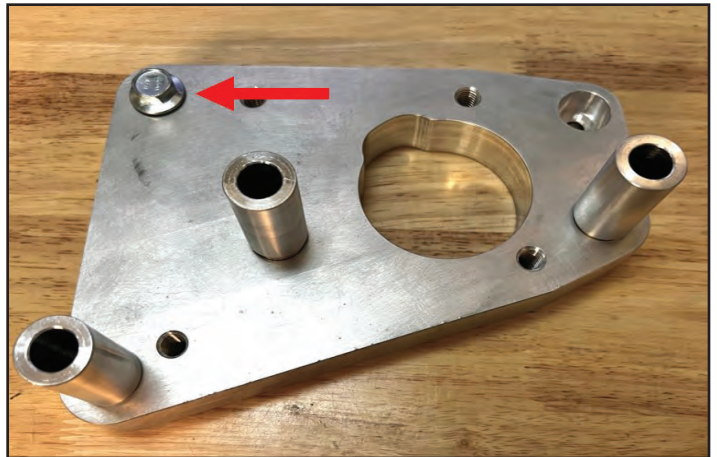

64. Remove the 2 fasteners encircled in the photo from the front cover. Plug in crank position sensor at the arrow.





65. Photo of the idler bracket with all fasteners pre-installed.

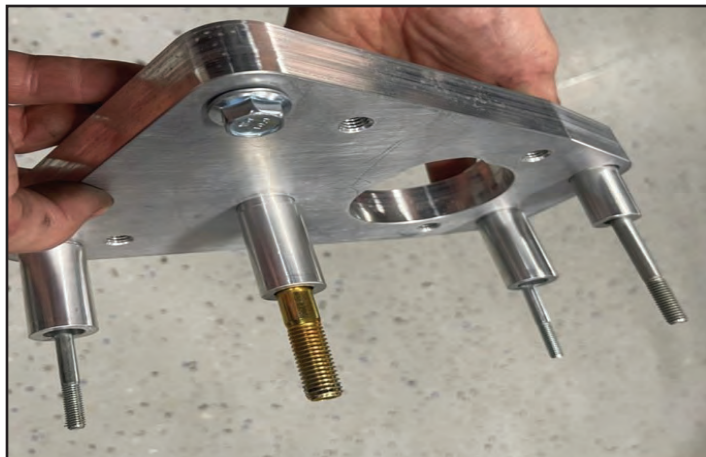

66. Install the supercharger idler bracket onto the front of the engine. Four fasteners secure it through the front cover.

**Apply Loctite 242** to bolts and tighten three times, according to the sequence shown: zero torque, 50% final torque, then final torque.

1. 110mm long M8 with 13mm hex head:  
**Torque to 23 ft-lbs.**
2. 110mm long M6 with 10mm hex head:  
**Torque to 108 in-lbs.**
3. Same as #2
4. 120mm long M12 with 16mm hex head:  
**Torque to 78 ft-lbs.**

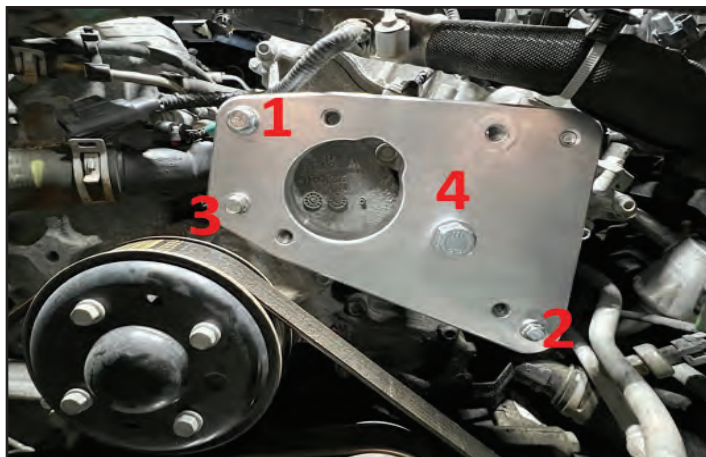

67. Remove the 15mm bolt from the automatic tensioner assembly. Replace the ribbed idler from the tensioner with the 60mm smooth idler (pn 56-06-01-060) and 17mm ID washer as a spacer between the bearing inner race and tensioner post. **Add Loctite 242** to the factory M10 bolt and hand tighten.

Do not discard the original ribbed idler and bearing cover, they will be re-used in a later step.



68. Install the tensioner on the supercharger idler bracket using two 40mm long M10 fasteners.

**Apply Loctite 242** to bolts.

**Torque tensioner mounting bolts to 45 ft-lbs**  
**Torque idler bearing bolt to 31 ft-lbs.**

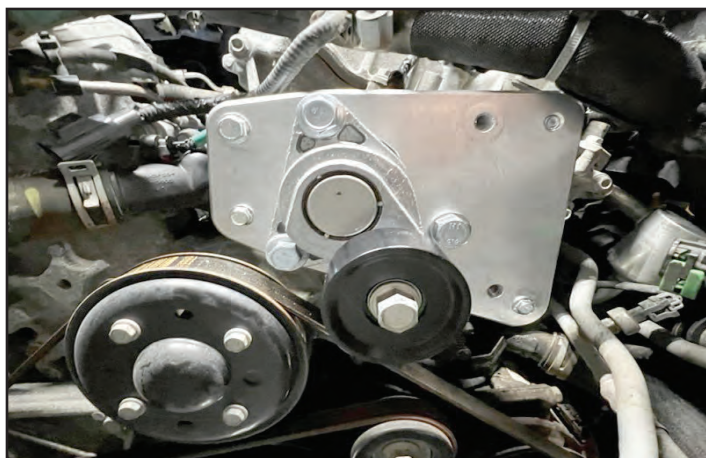



69. Install the idler/post assemblies onto the billet bracket in the locations shown in the inset photo and the main photo.

The smooth idler goes in the top location. The ribbed pulley and bearing cover plate that were harvested from the OE tensioner in the previous step are installed in the lower position as shown. Fasten it using the 85mm long M10 fasteners from the kit. **Apply Loctite 242 to bolts and torque to 45 ft-lbs.**

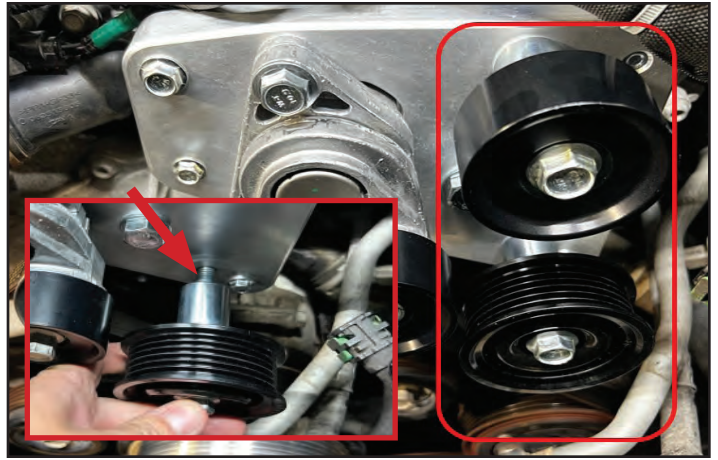

70. Reconnect the vacuum pump fitting to the pump, ensuring it locks in place. Reconnect the electrical harness, ensuring the lock on the hardshell connector is seated.

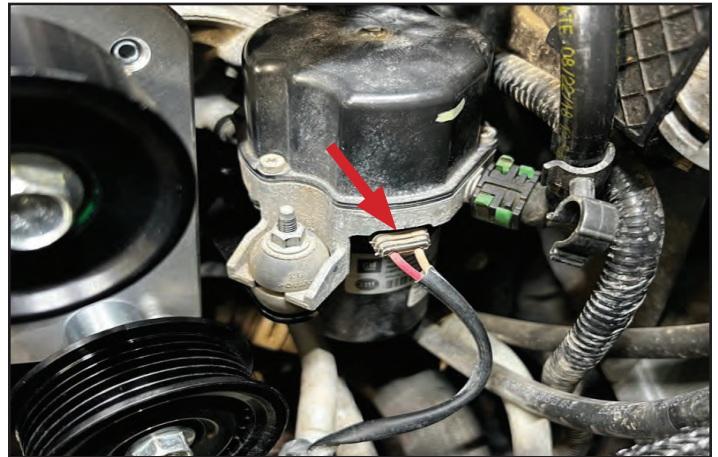

71. Remove a fir tree connector used to secure the factory wiring harness onto the inside front corner of the LH cam cover.



## Section 6: Supercharger Intake Manifolds

72. Remove port gaskets from factory air intake. Clean and insert into new lower intake.





73. Ensure all mating surfaces of the intake ports are clean. Ensure the factory foam cover is re-installed and seated into the valley of the engine (arrow location).

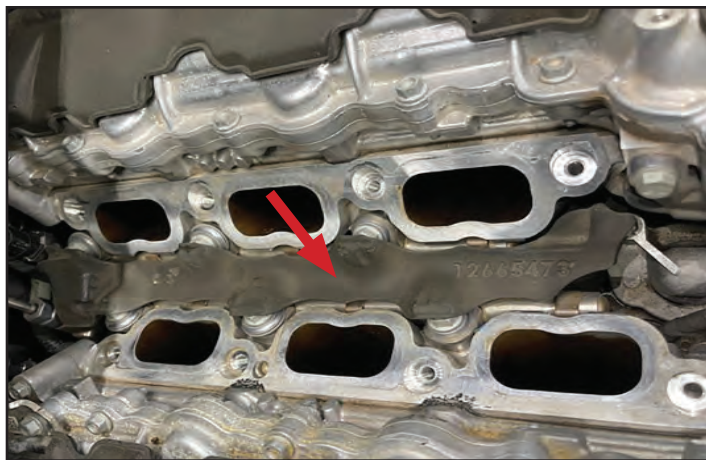

74. Install the lower intake manifold onto the engine ensuring the gaskets remain seated as it is lowered in place.

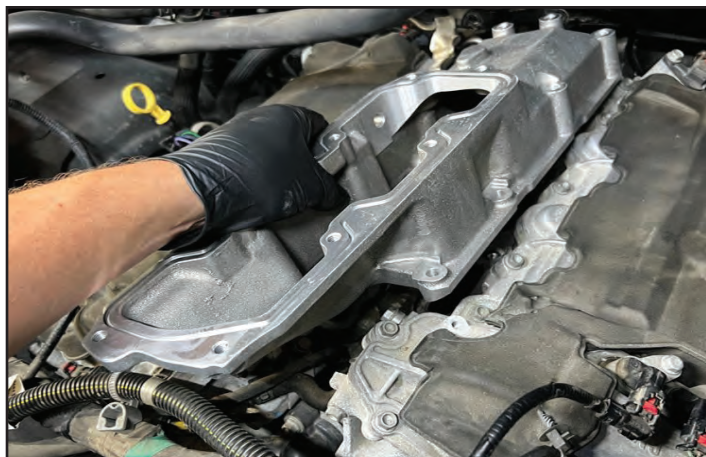

75. Hand-start all lower intake fasteners into the cylinder heads.

4x rear bolts, 75mm long M8 with 10mm hex head  
4x front bolts, 40mm long M8 with 10mm hex head

Zero torque all the bolts until they just make contact with the intake.



76. **Torque all the bolts starting from the center out and working in a criss-cross pattern in increments of 10/15/22 ft-lbs.**

Go back over all the fasteners a final time using the final torque setting ensuring they are fully tightened.





77. Install the temperature sensor. Tighten until seated onto manifold.



**The Next Step is Optional.**

We recommend replacing spark plugs on vehicles with over 20K miles. Factory plugs set to factory gap. Plugs are not provided with the kit.

78. Remove (6) connectors from the coils (3 per bank). LH side shown, RH side similar. Remove (6) coil bolts then pull all the coils out and set them aside. Remove (6) spark plugs. Install new spark plugs.

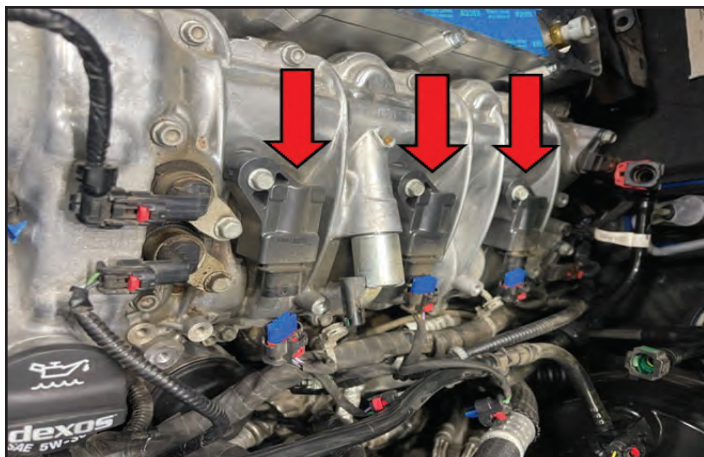

**Torque the new spark plugs to 13 ft-lbs.**

Re-install the coils and bolts.

**Torque the bolts to 8 ft-lbs.**

Re-install (6) coil connector ensuring the red locks are re-secured.

79. Install rear intake support bracket to rear engine bracket using factory M6 bolts and (2) serrated M6 nuts from the kit. Two 20mm long M8 bolts secure the bracket to the lower intake manifold. Loosely install all hardware with **Loctite 242** then:  
**-Torque the M8 fasteners to 18 ft-lbs.**  
**-Torque the M6 nut and bolt to 96 in-lbs.**

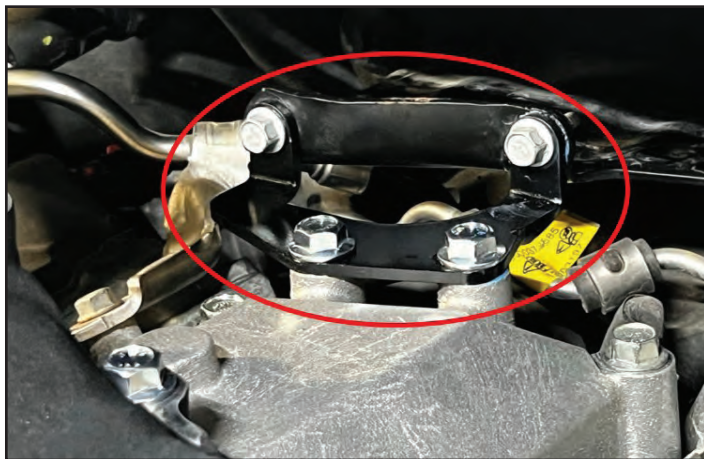

80. Gather the upper intake manifold shown. Remove the 4 bolts holding the charge air cooler (CAC) manifold using a 10 mm socket wrench.

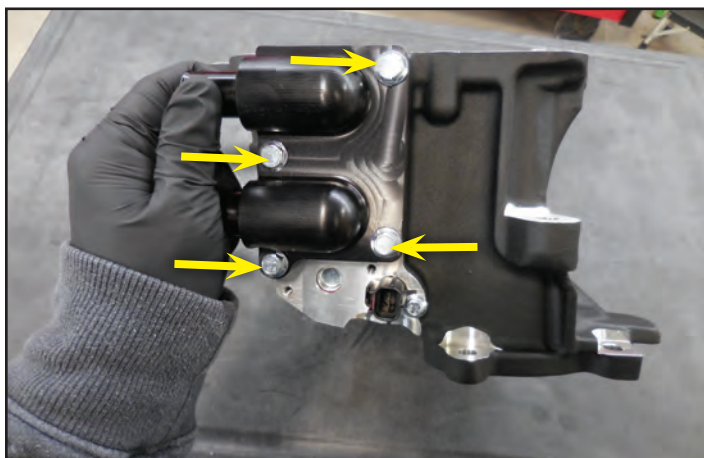



81. If you are adding a Boost gauge. Remove the 1/8" NPT plug from the rear of the Upper Intake Manifold and install the appropriate fitting. (not supplied) We recommend a 90 degree fitting for this application because the tight condition to the factory wire harness.



82. Protect the O-rings from any contamination or damage. These will need to be relubed for this assembly when it is reinstalled.



83. Remove the 10 bolts holding the CAC in place with an 8mm socket wrench. Ensure that you do not damage the CAC as you set it aside.

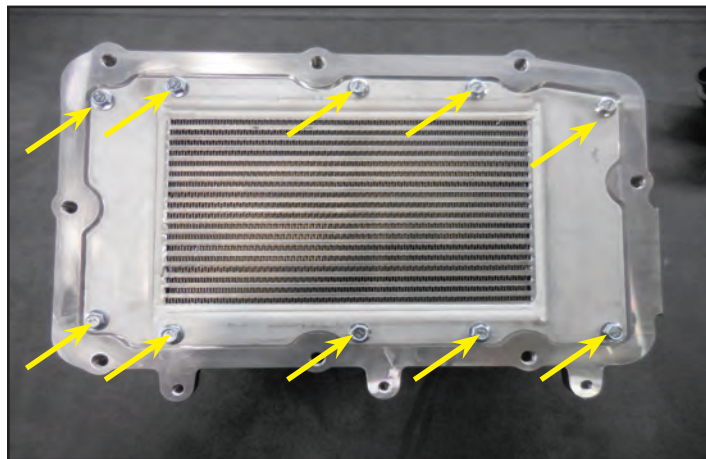

84. **(This image is from our Tacoma 3.5L install manual but the process is the same.)** Inspect the O-ring on the top of the lower intake manifold. Ensure that the surface is clean and free of any damage.



85. Gather the following eight M8x30mm bolts and **apply blue Loctite 242** to them. **Do not** use the dished head bolts shown below for this.



86. **(This image is from our Tacoma 3.5L install manual but the process is the same.)** Install the upper manifold onto the lower manifold using the bolts from the last step and a 12 mm socket wrench.



87. **(This image is from our Tacoma 3.5L install manual but the process is the same.)** Two of these bolts go inside at the arrow locations.

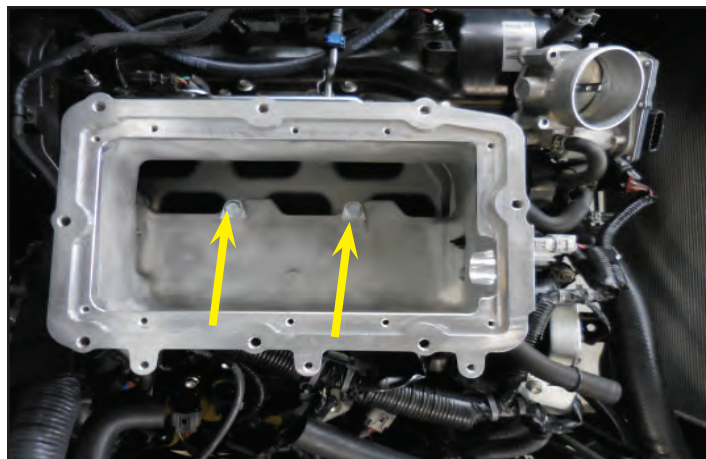

88. **Torque these bolts to 18 ft-lbs.** following the sequence shown. There is a larger version of this diagram at the back of this manual.

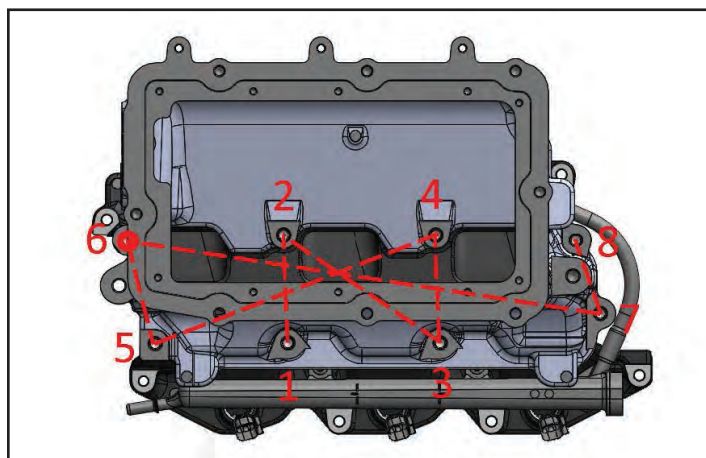



89. **(This image is from our Tacoma 3.5L install manual but the process is the same.)** Gather the ten M5 CAC bolts that were removed earlier and **apply blue Loctite 242** to them as shown below. Use the ten M5 bolts to reinstall the CAC with an 8mm socket wrench and **torque them to 80 in-lbs.**



90. Gather the CAC manifold with tubes installed, and the 4 bolts that were removed earlier. **Apply blue Loctite 242 to the bolts. Also apply a light coat of provided Lubriplate grease to the O-rings on the tubes and manifold shown with arrows.**

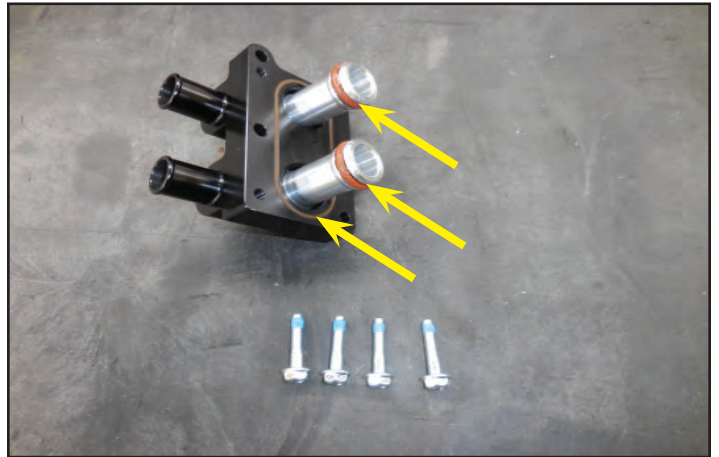

91. **(This image is from our Tacoma 3.5L install manual but the process is the same.)** Press the manifold evenly to ensure that the O-rings go in straight.



92. **(This image is from our Tacoma 3.5L install manual but the process is the same.)** Torque the 4 bolts to 108 in-lbs. using a 10 mm socket wrench.





93. Disconnect (3) left hand side coil connectors, rocker arm control valve connector and wiring harness fir tree connector to gain access to the LH cam cover bolts.

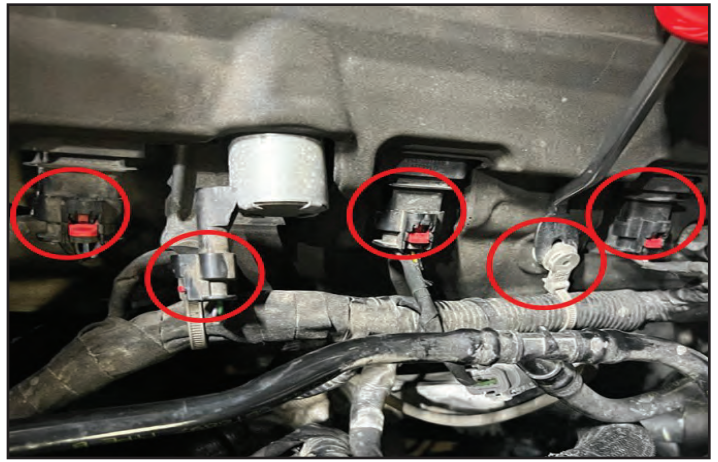

94. Remove the two bolts in the locations shown from the LH cam cover.



95. Install the rear supercharger lower support bracket using two 60mm long M6 bolts.

**Apply Loctite 242 and torque to 96 in-lbs.**

Reattach connectors and trees.



96. Cut zip tie holding the grey connector shown.





97. Install rear supercharger support bracket to the billet bracket installed two steps ago.

Use three 16mm long M6 bolts. Make sure the bracket bends in towards the center of the vehicle.

Tighten to hand tight only. Do not torque until after the supercharger housing has been installed.



98. Install the front supercharger support onto the previously installed bolt on the rear of the FEAD idler bracket.

Do not torque. Reconnect vacuum pump connector and zip tie to the back of the bracket.

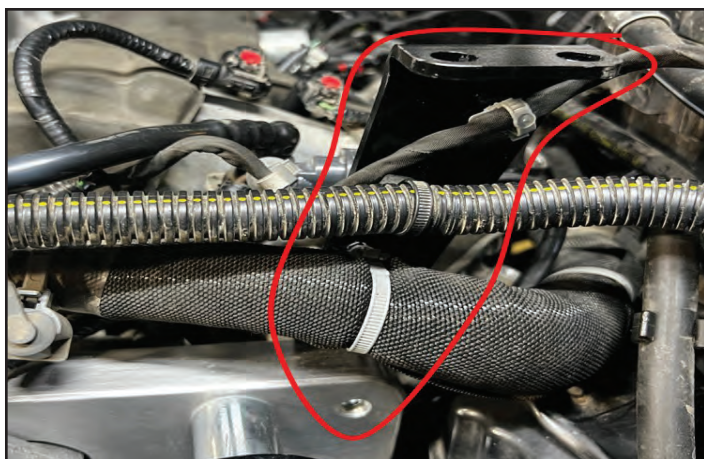

## Section 7: Supercharger Install

99. Install the supercharger into place beside the upper intake.

**Apply Loctite 242** to the two provided M10 fasteners and secure it in place at the locations shown with arrows.

**Install and torque the 2 fasteners to 33 ft-lbs.**

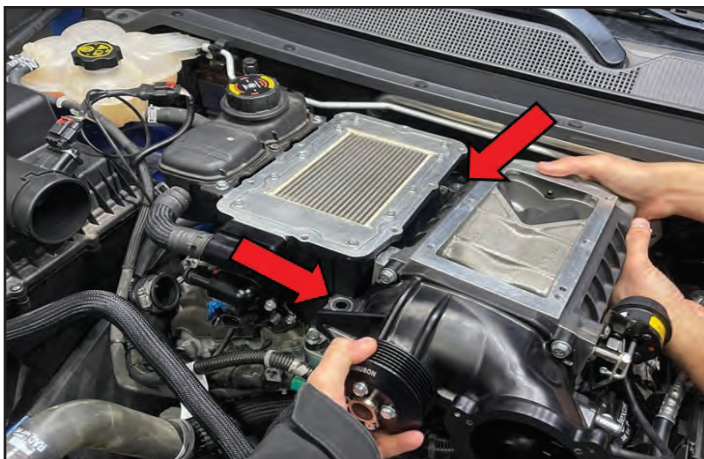

100. Attach the left-hand, front support bracket to the underside of the supercharger inlet, using 2x 20mm long M8 bolts. **Torque to 18 ft-lbs.**

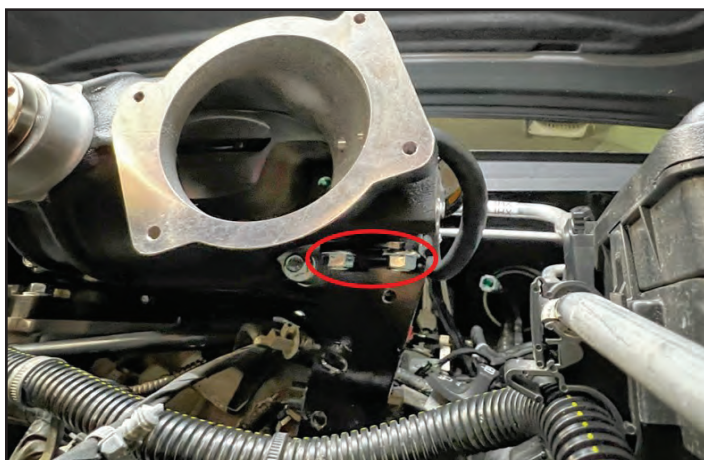



101. Attach the main harness bundle and battery cable fir tree connectors into the front of the bracket in the locations shown.



102. Attach the left-hand, rear support bracket to the side of the supercharger housing, using 2 more 20mm long M8 bolts. **Torque to 18 ft-lbs.**



103. Clean the sealing surface of the supercharger and upper intake manifold with lacquer thinner. Ensure that there are no imperfections in the sealing surface.



104. Remove the lid from the bag and check the gaskets for any imperfections.





105. These three circled M8 x 16mm bolts are pre installed. **All the lid bolts will have the dished heads shown below.**

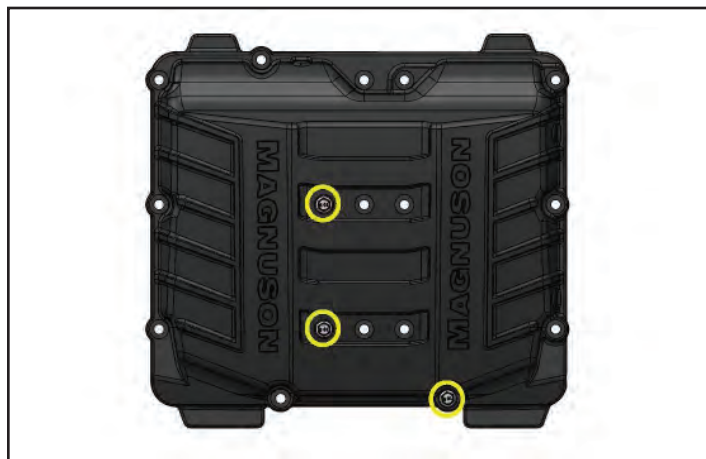

106. Lid fastener layout:  
 Three M8x16mm (FAUX-IN **YELLOW**)  
 Ten M8x30mm (PERIMETER-IN **RED**)  
 Two M8x45mm (FRONT CENTER-IN **GREEN**)  
 Two M8x65mm (REAR CENTER-IN **BLUE**)

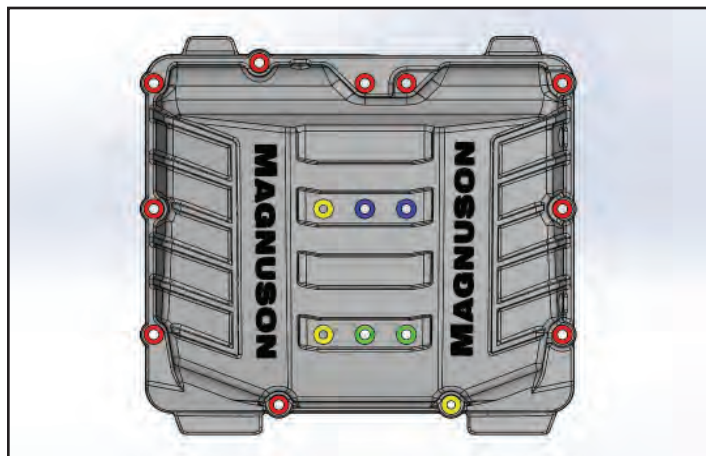

There is a larger version of this at the back of this manual.

107. **Apply blue Loctite 242** to all fasteners. Install lid fasteners hand tight. Then tighten both numeric (yellow) and alphabetical (red) sequence as shown in two cycles. **Tighten the first cycle, yellow and red to 8 ft-lbs. Then do another final cycle in sequence yellow and red at 18 ft-lbs.** There is a larger version of this in the back of this manual.

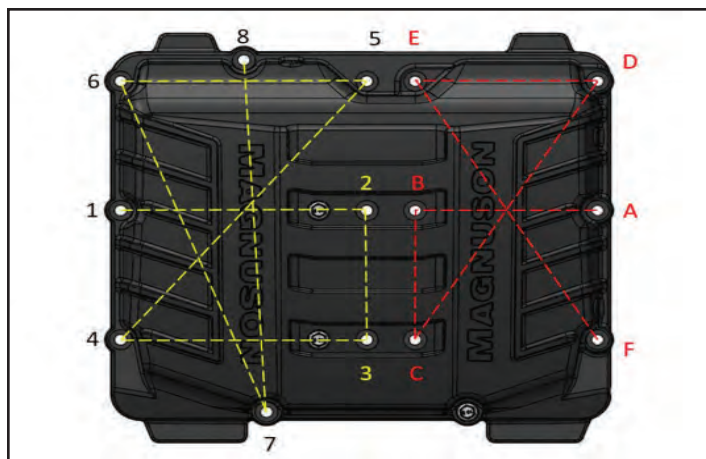

108. Torque the 3x 10mm hex head bolts at the bottom of the rear bracket circled in red to **108 in-lbs.**

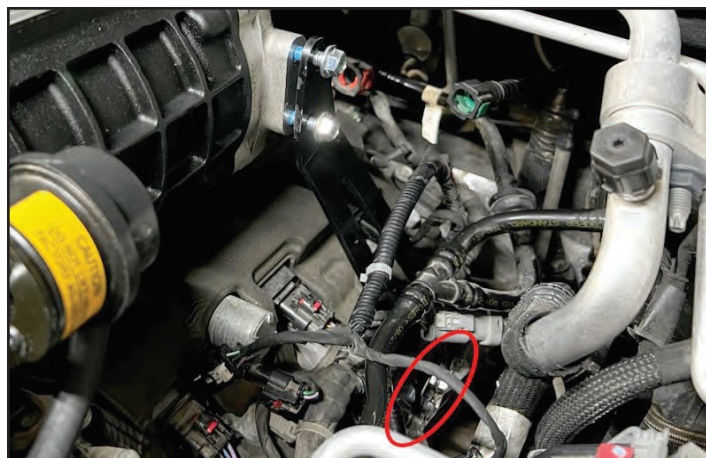

109. Using a crow's foot adapter, torque the 15mm hex head bolt (at red arrow) that attaches the front support bracket to the idler bracket.

**Torque to a "calculated" 55 ft-lbs.**

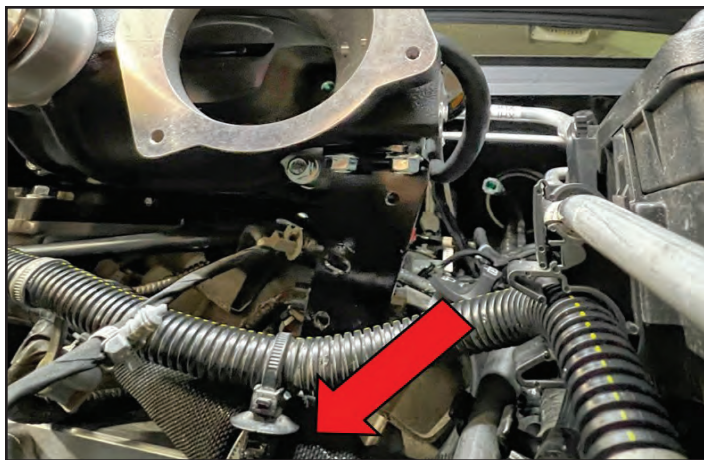

110. Install the factory EVAP valve into the back of the supercharger inlet. Secure it with the factory fastener. **Torque the fastener to 96 in-lbs.**



111. Harvest the original MAP sensor from the factory intake and install it onto the supercharger inlet at the location shown using a 25mm long M6 bolt.

**Torque the fastener 96 in-lbs.**

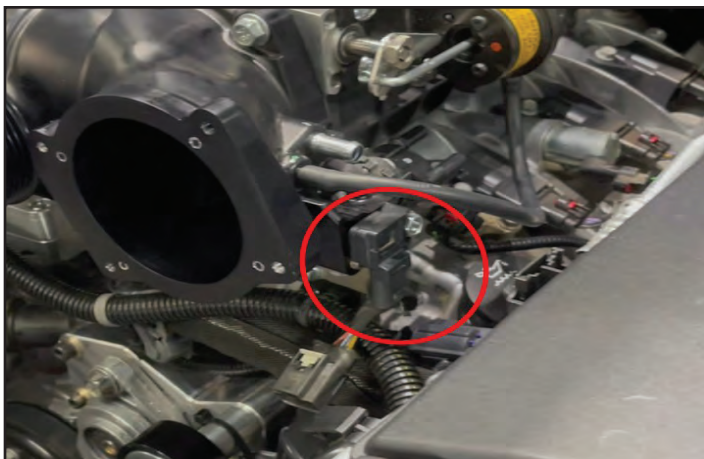

112. Install (2) fir tree connectors into the bracket, just below the throttle body inlet.





113. Install throttle body gasket onto throttle body, then pre-install the (4) factory throttle body fasteners into holes.



114. Install throttle body onto supercharger inlet.

**Torque (4) fasteners in a criss-cross pattern to 96 in-lbs.**



115. Route the throttle body harness connector around the front of the supercharger bracket. Connect the harness to the throttle body in the location shown.

Ensure the connector is fully seated then apply the gray lock by sliding it toward the throttle body.



116. Select (4) M6 X 16mm long fasteners.

Apply blue thread locker to the fasteners then install them through the pulley into the hub on the front of the supercharger.

**Torque the pulley bolts 108 in-lbs. in a criss cross pattern.**

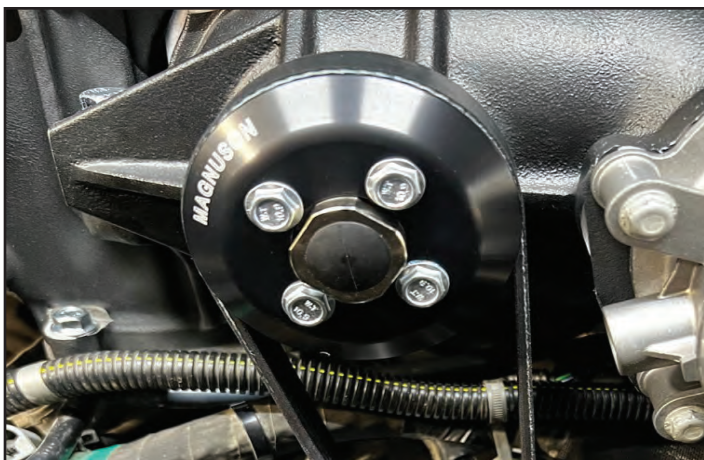



117. Install supercharger drive belt following belt routing shown in the photo. There is a larger version of this photo in the back of this manual.

Cycle tensioner and slip belt over supercharger pulley

Inspect belt to ensure it is installed properly around all pulleys.



## Section 8: Intercooler System Routing

118. Install the supercharger coolant pump bracket to the top side of the right-hand wheel well, in the orientation shown, using (1) 16mm long M8 and the serrated flange nut from the kit.

**Apply Loctite 242 and torque to 23 ft-lbs.**



119. Attach the supercharger coolant pump to the bracket using the provided worm gear clamp in the orientation shown.

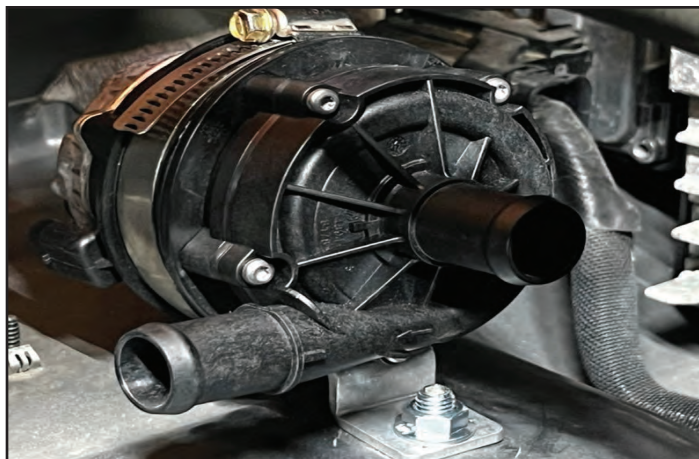

120. Install the supercharger coolant reservoir using (3) 16mm long M6 bolts.

**Apply Loctite 242 and torque to 40 in-lbs.**

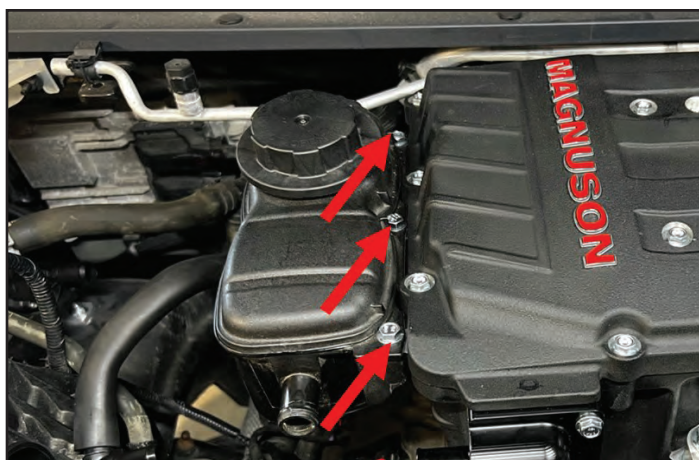



121. Install hose (A) between fill reservoir and charge air cooler upper tube.

Ensure constant tension clamps are installed at each end and positioned over the center of the tubes.



122. Install hose (B) between fill reservoir and pump.

Ensure constant tension clamps are installed at each end and positioned over the center of the tubes.

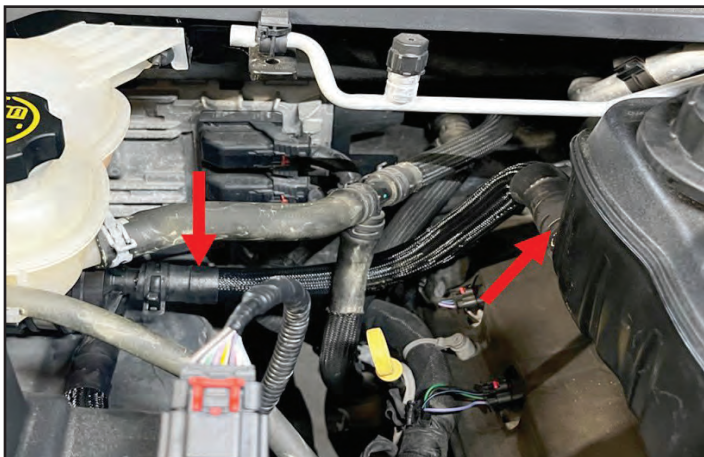

123. Install hose (C) from pump, down around the front bumper and over the left side of the vehicle in front of the radiator.

Ensure constant tension clamps are installed at each end and positioned over the center of the tubes.

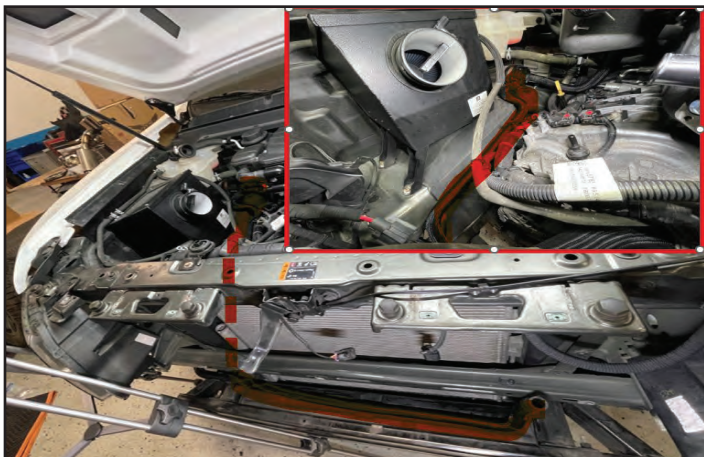

124. Using a trimming tool cut a hole out of the plastic air dam on the right-hand side.





125. Install hose (D) from the charge air cooler lower tube, through the hole in the air dam.

Ensure constant tension clamps are installed at each end and positioned over the center of the tubes.

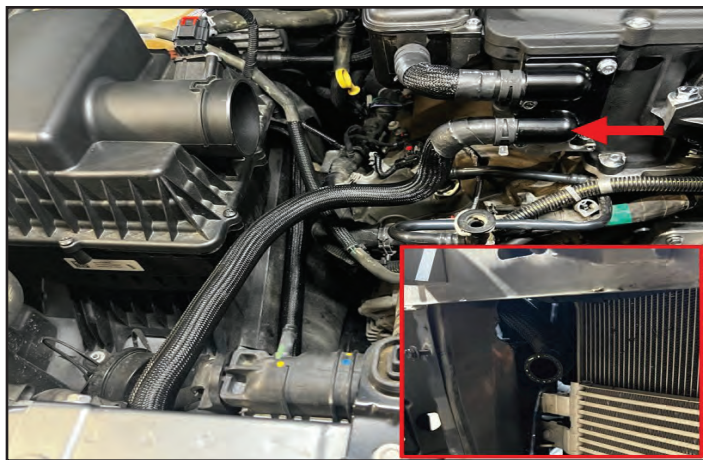

126. Take the provided 12" length of 5/8" heater hose and cut it open along its length.

Place the hose cut side down along the horizontal brace in front of the radiator.

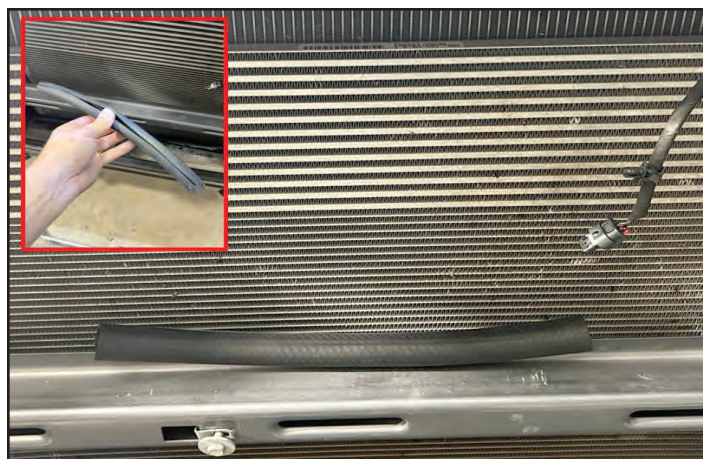

127. Remove the hood latch assembly, disconnect the black hardshell connector.



128. **This step is only required on some vehicles, check fitment on vehicle prior to cutting.** Trim the tabs on the bottom of the provided Low temp radiator (LTR) to make them equal length.





129. Install the LTR, centering the lower tabs over the 5/8" hose on the horizontal brace.

Connect the hose (C) coming from the pump to the bottom of the LTR.

Connect the hose (D) going to the charge air cooler to the barb at top of the LTR.

Ensure constant tension clamps are installed at each end and positioned over the center of the tubes.

130. Re-install the hood latch assembly, placing the upper LTR bracket between the latch bracket and the washers. Use witness marks to position the bracket **apply Loctite 242** and tighten the bolts snug.

**Gently** shut the hood to check alignment, hood should close easily but without any free play when latched. Re-adjust latch assembly if necessary.

**After checking alignment, torque hood latch bolts to 16 ft-lbs.**

131. Re-connect the black hard shell connector from the hood latch assembly.

132. Remove the fitting shown.

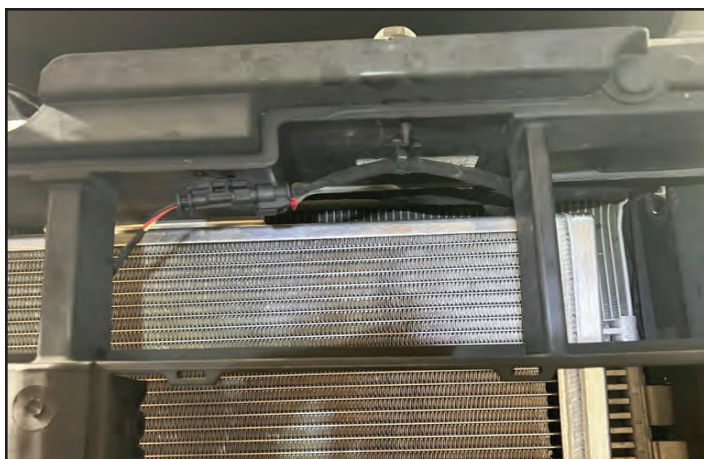



133. Attach the provided 2 1/4" long section of 5/8" fuel safe hose P/N 82-05-08-025 to the factory PCV line elbow.

Attach the 90° SAE fitting PN 48-46-02-064 to the opposite end of the short hose as shown.

The SAE fitting will connect to the clean air tube in a subsequent step.



134. Disconnect the factory MAF connector on the airbox. Connect the provided MAF breakout harness P/N 82-55-80-035 to the sensor on the airbox, then connect the factory MAF connector to the other end. Be sure that the connectors are both fully seated, slide in the red push lock.

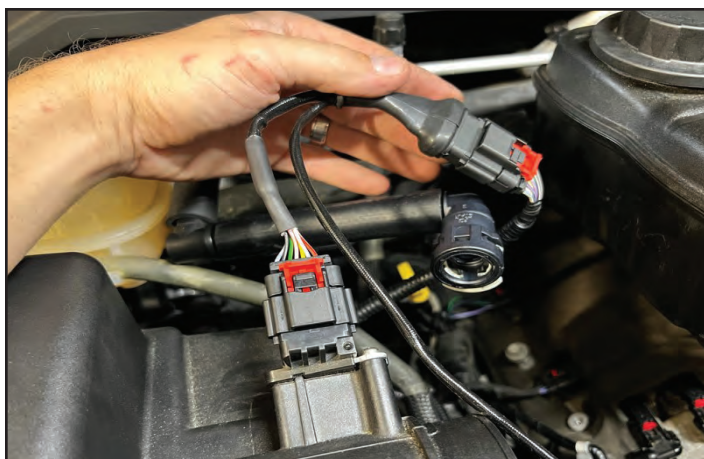

135. Connect the third branch on the MAF breakout harness to the temperature sensor on the RH side of the lower manifold.

Zip tie excess cable along factory harness.



136. Connect the pump wire harness to supercharger intercooler pump.

Zip-tie after grey connector to hose (C) as shown.

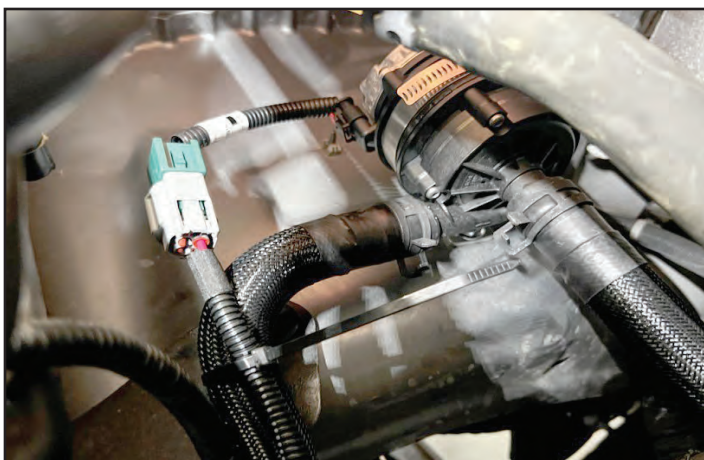



137. Zip-tie pump harness to main vehicle harness traveling cross-car to in front of the supercharger at the arrow locations.

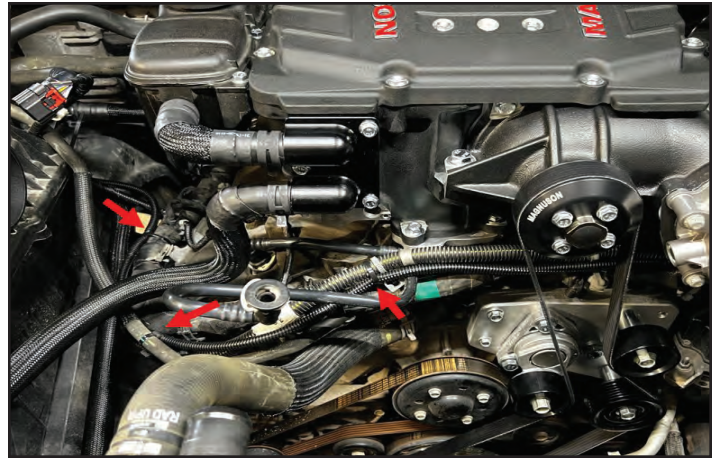

138. Remove the fuse box covers. Attach the RED POSITIVE eyelet (exits the pump wiring harness loom together with the yellow wire) to the stud on the front of the fuse box (shown encircled at the right of the photo).

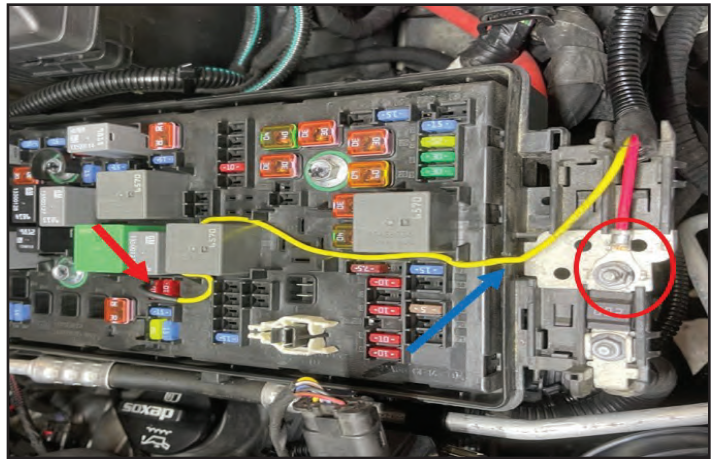

Remove the 10A fuse in position F46. Install the yellow jumper wire onto the fuse then re-install the fuse back into position F46 (red arrow).

To prevent pinching the yellow wire, make a small clearance cut in the fuse box housing and lid (blue arrow). Route the yellow wire through the clearance cut.

Re-attach the fuse box covers.

139. Attach the second eyelet (BLACK ground) on the pump wire harness under the bolt in the location shown in front of the windshield washer reservoir.



**Torque to 96 in-lbs.**

140. **Remove the fuse cover from the pump relay harness (photo below) and install the provided 15 Amp fuse.** Re-install the fuse cover ensuring it snaps in place.

Secure the relay under the fir tree connector on the left-hand side inner fender.

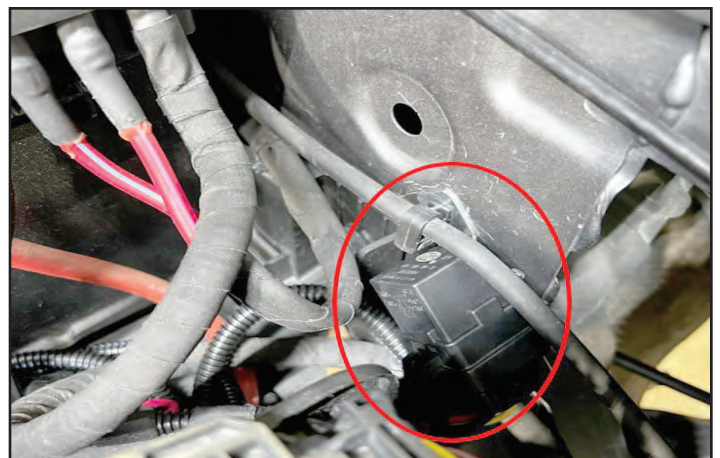



141. Re-install the engine cooling fan/shroud assembly. Secure it by re-installing the factory fastener on each side of the shroud.

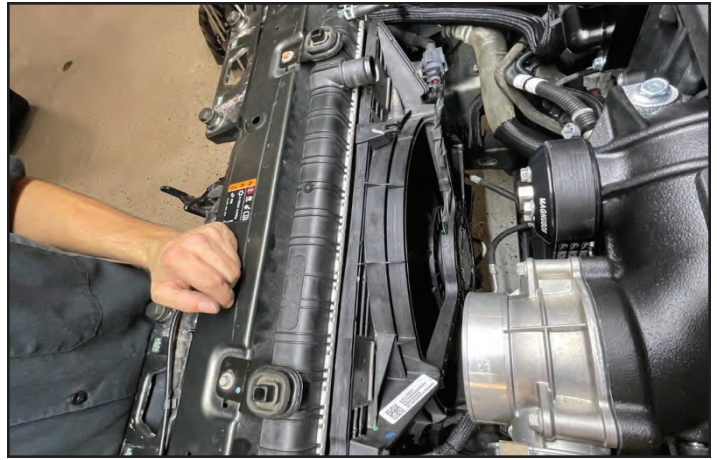

142. Re-attach the upper radiator hose and secure it to the radiator using the factory constant-tension clamp.



143. Re-connect the grey hardshell connector on the RH side of the fan shroud.



## Section 9: Final Assembly and Testing

144. Install the air intake tube assembly ensuring it is fully seated onto the mass air meter and throttle body.

Secure it by tightening the gear clamp on each end.





145. Connect the PCV fittings shown to the air intake tube.

Cycle the locks on the connectors and ensure they are secured to the fittings on the air intake tube.

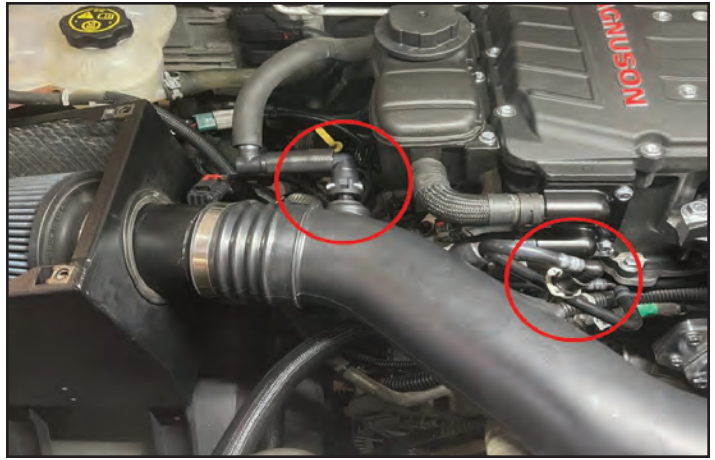

146. Connect the EVAP extension wiring harness PN 82-55-80-032 to the EVAP solenoid on the LH side of the supercharger.

The opposite end of the extension harness connects to the factory EVAP harness takeout.

Zip tie the extra length of the EVAP harness extension to the factory wiring as shown in the inset photo.

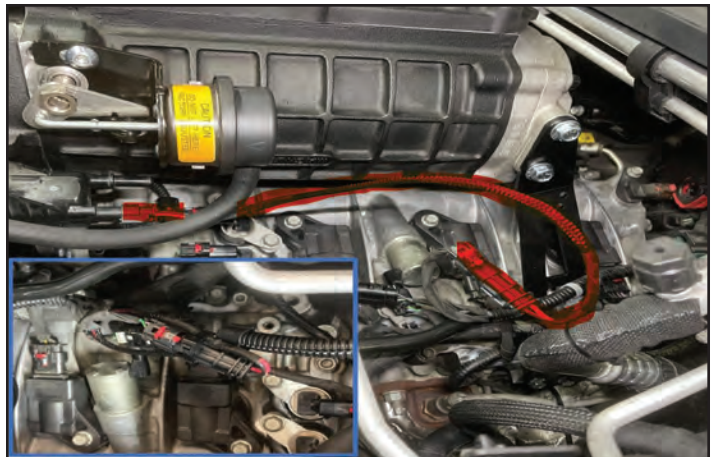

147. Select Hose E from the kit.

Slip an Oetiker clamp over the end of the hose with the larger bend radius.

Insert an 11.8mm barbed male SAE fitting into the end of Hose E which has the larger bend radius (shown at the bottom of the photo).

Secure the SAE fitting to the hose with the provided stepless ear/Oetiker clamp .



148. Install Hose E onto the vehicle.

Connect the tighter 90° end of Hose E to the barb fitting on the supercharger inlet.

Secure it with the provided constant tension clamp.

Insert the male SAE fitting into the female quick connect for the brake vacuum line at the back of the engine. Ensure the lock on the connector is cycled.



149. Insert the 5/16" MALE barbed SAE fitting into the provided 12" long, 5/16" diameter fuel safe hose. Secure with the provided 15.7 stepless ear/Oetiker clamp.

Install a second 15.7 Oetiker clamp onto the opposite end of the hose then insert the 5/16" FEMALE barbed SAE fitting into the hose.

This hose assembly will be installed in the following slide.



150. Connect 5/16" hose assembly between the EVAP Solenoid and the factory connection under the cowl as shown.



151. Connect the provided MAP extension to the map sensor and its wiring harness.

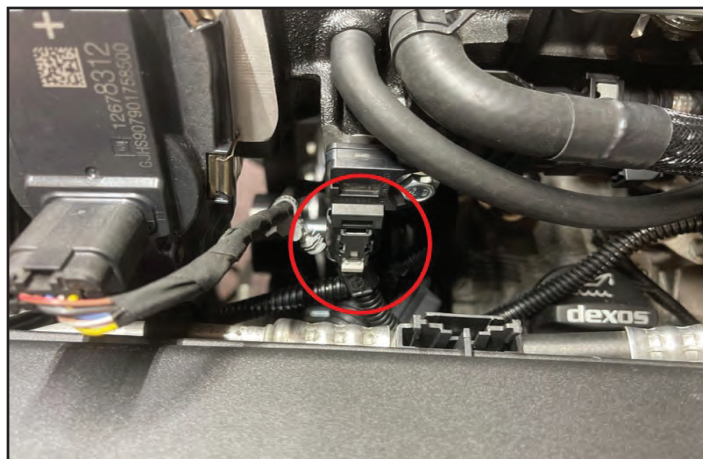

152. Evacuate the air from the engine coolant system and fill it back to the correct level using the manufacturers recommended mixture of coolant. Ensure the radiator petcock is closed. You will need to re-check the coolant level after the engine heat cycles and the thermostat opens.





153. Reconnect the negative terminal of the battery.



**Make sure that you have followed the steps at the beginning of this manual to load the proper Supercharger calibration to your vehicle's ECM.**



154. **\*\*\*WARNING: You must perform a vacuum leak down test on your intercooler system prior to adding any coolant. This can be accomplished with the same equipment that is used for engine cooling systems.\*\*\***

Add the same coolant mixture as in the engine radiator to the intercooler reservoir. Set the ignition to the accessory position and allow the pump to cycle while you fill the system. Do Not start the engine. Ensure that the pump does not run dry while you are filling the system. The coolant level should be within 1/2" from the top surface on the front of the tank. This will allow for coolant expansion.



155. Start the vehicle for 5 seconds and shut it off. Check for belt alignment. Check the intercooler reservoir level and engine coolant level. Now start your engine and let it run for a few minutes to let it get to operating conditions. Let the engine cool down, and check all your levels again.



156. If there are no leaks you can reinstall the grill following the instructions from earlier in reverse.



157. We recommend removal of hood liner due to minimal clearance to supercharger lid.



158. Test drive the vehicle for the first few miles under normal driving conditions. Do not perform any wide open throttle runs. Listen for any noises, vibrations, engine misfire or anything that does not seem normal. The supercharger does have a slight whining noise under boost conditions, which is normal. Check and top off the intercooler reservoir and radiator as needed.



159. After the initial test drive gradually work the vehicle to wide open throttle runs, listen for any engine detonation (pinging). If engine detonation is present let up on the throttle immediately. Most detonation causes are low octane gasoline still in the tank.





160. Please enjoy your “Magnuson SuperCharged” performance responsibly. Use only premium gasoline fuel, 91 octane or better.

If you have questions about your vehicles performance, please check with your installation facility.

**After you finish your installation and road test your vehicle, please fill out the warranty registration. This can be found on our website.**



## Appendix

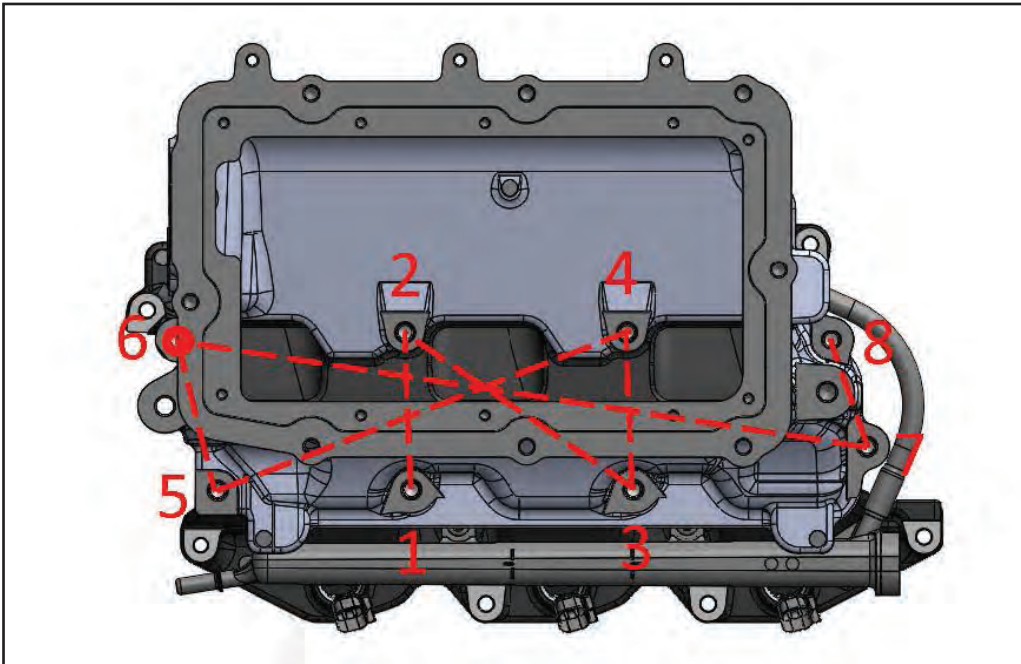

Torque Sequence for Upper Intake Manifold (18 ft-lbs)

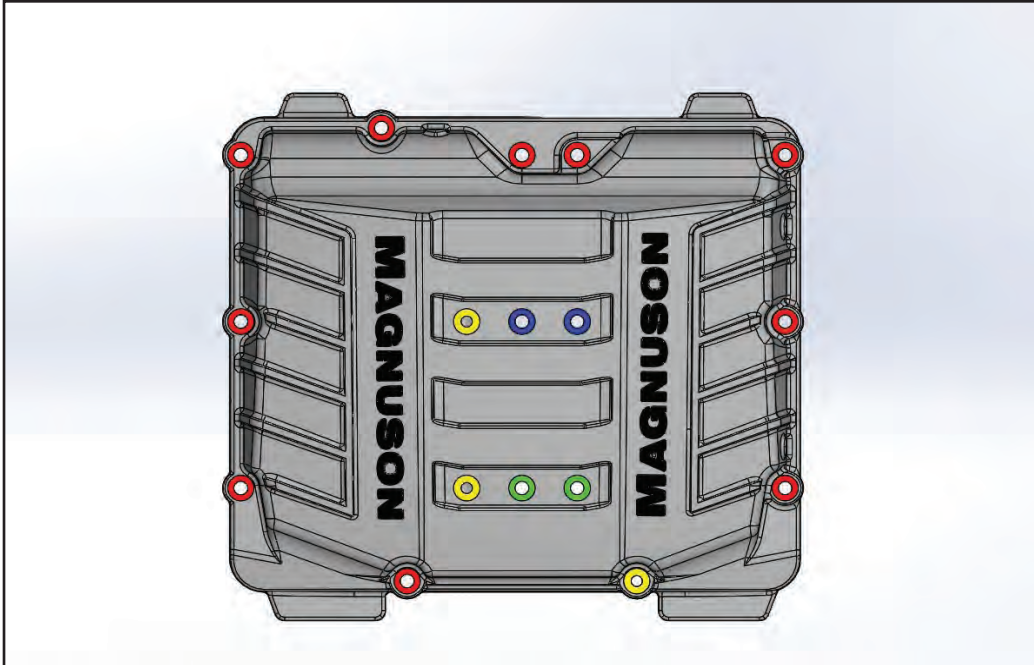

### Lid fastener layout:

Three M8x16mm (FAUX-IN **YELLOW**)

Ten M8x30mm (PERIMETER-IN **RED**)

Two M8x45mm (FRONT CENTER-IN **GREEN**)

Two M8x65mm (REAR CENTER-IN **BLUE**)



## Appendix

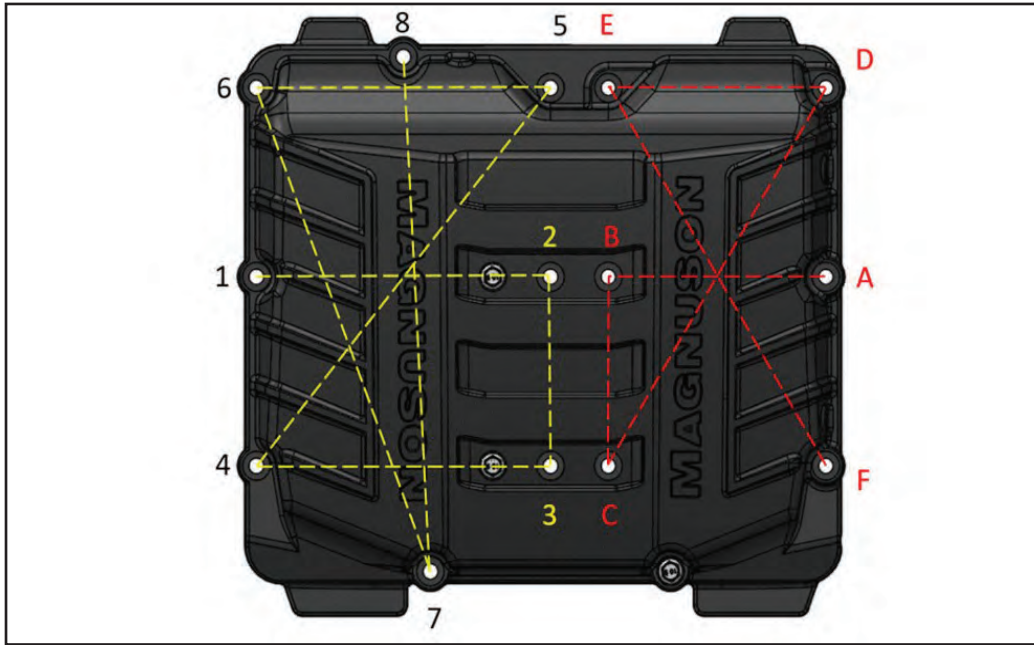

Torque Sequence for Lid (18 ft-lbs)

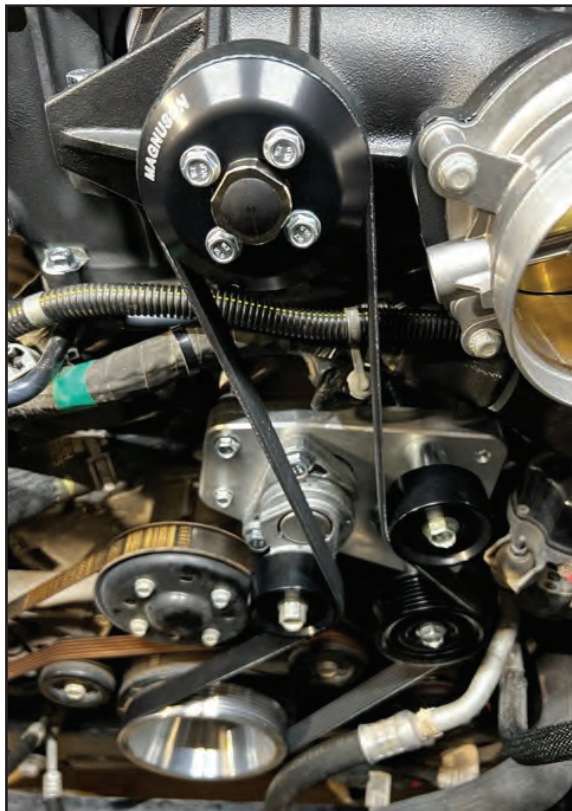

Supercharger Belt Routing

# NOTES



# NOTES



Please enjoy your “Magnuson SuperCharged” performance responsibly.

**Use only premium gasoline fuel, 91 octane or better.**

**MAGNUSON**  
*SUPERCHARGERS*