

MAGNUSON

SUPERCHARGERS

Installation Instructions for:
CORVETTE MAGNUM DI
SUPERCHARGER SYSTEM
2014*-2019 C7 LT1 CORVETTE



***2014 models require an updated 2015+ water pump.**

*** PREMIUM GASOLINE FUEL REQUIRED ***



ATTENTION!

Your **MAGNUSON SUPERCHARGER** kit
is sensitive to corrosion!

Use **only the vehicle manufacturer**
recommended coolant for your engine in
the intercooler system as well.

Magnuson Superchargers
1990 Knoll Drive, Bldg A, Ventura, CA 93003

(805) 642-8833

magnusonsuperchargers.com

INSTALLATION MANUAL

Magnuson Supercharger Magnum DI Kit GM 6.2 Liter Engine Chevrolet Corvette 2014-2019 LT1

Please take a few moments to review this manual thoroughly before you begin work. Make a quick parts check to be certain your kit is complete (see Bill of Material (BOM) parts list inside the accessory box). If you discover shipping damage or shortage, please call our office immediately. Take a look at exactly what you are going to need in terms of tools, time, and experience. Review our limited warranty with care. When unpacking the supercharger kit DO NOT lift the supercharger assembly by the black plastic bypass actuator. This is pre-set from the factory and can be altered if used as a lifting point!

Caution: Relieve the fuel system pressure before servicing fuel system components in order to reduce the risk of fire and personal injury. After relieving the system pressure, a small amount of fuel may be released when servicing the fuel lines or connections. In order to reduce the risk of personal injury, cover the regulator and fuel line fittings with a shop towel before disconnecting. This will catch any fuel that may leak out. Place the towel in an approved container when the job is complete.

Use only premium gasoline fuel, 91 octane or better.

Magnuson Superchargers recommend that you run a minimum of one (1) tank of premium fuel through your vehicle prior to installation of the system to prevent any possible damage that may occur due to running the supercharged engine on lower octane fuel.

Magnuson Superchargers systems are designed for engines and vehicles in “GOOD” mechanical condition. Magnuson Superchargers recommend that a basic engine system “Health Check” be performed prior to the installation of this supercharger system. Be sure to check for any pending or actual OBDII codes and fix/repair any of the stock systems/components causing these codes. If there are codes prior to the installation they will be there after the installation.

Magnuson Superchargers also recommends the following services to be performed on your vehicle before starting and running the vehicle post supercharger system installation:

- Fuel Filter change
- Engine oil and filter change using brand name oil (organic or synthetic) and filter
Note: It is VERY IMPORTANT to use the factory specified oil viscosity. The original equipment manufacturer has selected this grade of oil to work with your other engine systems such as hydraulic chain tensioners and variable cam controls. Deviation from this specification may cause these systems to fail or not function properly. Please refer to your owner’s manual for the recommended oil viscosity for your engine and application.
- On newer vehicles not requiring new spark plugs it is important to verify the spark plug air gap.

On older vehicles Magnuson Superchargers recommend these additional services to be performed:

- New spark plugs with the air gap set at the factory specifications OR new specifications if required by the installation manual.
- Coolant system pressure test and flush. **NOTE: YOU MUST USE GM SPECIFIED COOLANT MIXTURE.**

Non “Magnuson Approved” calibrations or “tuning” will Void ALL warranties and CARB certification.

Tools Required

Metric wrench set
1/4" - 3/8" and 1/2" drive metric socket set (standard & deep)
3/8" and 1/2" drive ft-lbs and in-lbs torque wrenches
Phillips and flat head screwdrivers
1/2" breaker bar
Serpentine belt wrench
Fuel line quick disconnect tools (included in kit)
Funnel
Hose cutters
Hose clamp pliers
Safety glasses
Hammer
Nut driver
Compressed air
Heat gun
Metric Allen socket set 3/8 drive
Metric Allen wrenches
Torx socket set 3/8 drive
Plastic pry bar
Oetiker clamp pliers
Rotary Cutting Tool or Hacksaw
Band Saw

Contact Information:

Magnuson Superchargers
1990 Knoll Drive, Bldg A
Ventura, CA 93003

Sales/Technical Support Line (805) 642-8833
Website www.magnusonsuperchargers.com
Emails sales@magnusonsuperchargers.com
support@magnusonsuperchargers.com

Table of Contents

Section 1: Tuning your Vehicle Computer and Initial Steps	5
Section 2: Removal of Factory Intake Manifold and Accessories	6
Section 3: PCV Relocation	18
Section 4: Fuel Line Replacement	21
Section 5: Supercharger Preparation and Installation	24
Section 6: Throttle Body, Brake Booster Line, and EVAP Line Installation	37
Section 7: Front Fascia Removal	44
Section 8: Crank Pulley Replacement	50
Section 9: Tensioner Assembly, and EVAP Solenoid Installation	55
Section 10: Low Temperature Radiator (LTR) Installation	57
Section 11: Cooling Pump, Reservoir and Hose Installation	64
Section 12: Hood Liner Removal	74
Section 13: Coolant Fill, Reinstall Body Panels, and Final Testing	75
Appendix	78

Section 1: Tuning your Vehicle Computer and Initial Steps

Any reference to left or right side of vehicle is given from driver's seat perspective.

1. If your kit has a provided handheld tuner follow the instructions in the provided pamphlet to install your tune. **WARNING: DO NOT BEGIN THE INSTALLATION BEFORE OBTAINING YOUR NEW CALIBRATION FILE. IN SOME CASES, ESPECIALLY WITH NEWER VEHICLES, THIS STEP CAN TAKE SEVERAL DAYS AND YOUR VEHICLE WILL BE IMMOBILIZED WHILE YOU WAIT FOR THE NEW CALIBRATION FILE.** Your handheld tuner may not match the one shown.
2. Your Intercooler system is sensitive to corrosion. It's very important to use the OEM recommended coolant mixture in your supercharger system as well.
3. Your system requires the use of minimum 91 Octane gasoline fuel. This system is **not** compatible with E85 fuel.
4. Remove the negative cable from battery with a 10mm wrench. The battery is located in the right rear of car under the carpet. Place a rag over the negative terminal to prevent accidental connection. Place a rag over the rear hatch latch to prevent locking.



5. Install fender covers to protect the paint while working on the car. Remove the radiator duct bolts (4 each) with a 7mm nut driver. Remove the radiator duct.

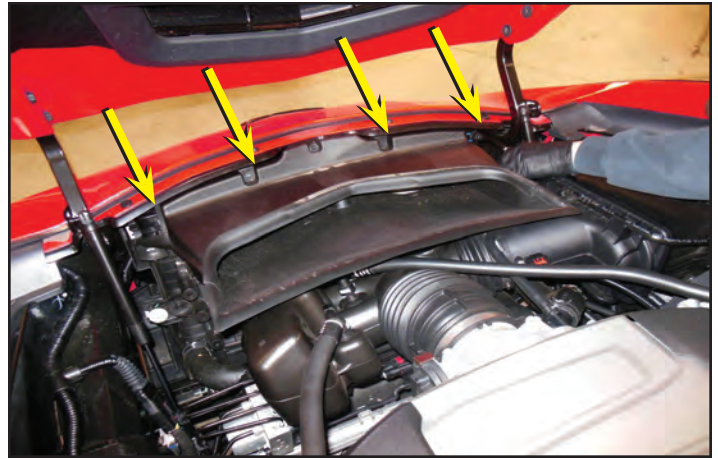

6. Remove the plastic beauty covers (2 each) by pulling up on the inboard side. Then push towards the middle of the vehicle. Repeat on the opposite side of the engine.



Section 2: Removal of Factory Intake Manifold and Accessories

7. Remove the vent hose from indicated locations shown. Push the gray buttons on connector to release. Keep the hose for reuse.



8. Release the four quick connects on the dry sump vent hose assembly. Release the plastic clip securing the hoses near the alternator.



- Take extra care while removing the hose at the valve cover connection. Pry from the top slowly. Do not pull left-right or you will break off the internal plastic clips.



- Dry sump vent hose assembly can now be removed.



- Remove the air duct shown with an 8 mm nut driver or a slotted screwdriver. Loosen the clamps at the throttle body, and air box. This part will not be reused.



- Disconnect the Mass Air Flow (MAF) sensor harness by pulling back on the red slide, and pushing down on the black tab. Do not remove the sensor.



13. Disconnect the Manifold Absolute Pressure (MAP) connector. This is located near the left side valve cover. Pull blue tab to the side to unlock connector prior to removal.



14. Unplug the Electronic Throttle Control (ETC) connector where shown. Pull back on the red plastic lock first, then push down on the black tab to disconnect.



15. Use a plastic pry bar to remove 4 wire tie anchors on both sides of the intake manifold cover.



16. View of the wire tie anchors dismantled. Remove the cable ties by releasing the clamps if you would like to reuse them, or cut them off. Repeat on right side of engine.



17. Disconnect the EVAP connection from the right side front of the manifold. Pull back and push in on the grey plastic locking tab to release the connector.



18. Remove the bolts (4 each) holding the manifold cover in place. These will require a 10 mm 3/8" drive deep socket to get over the stand-off connectors for the coil covers. Arrows indicate the four locations.



19. The manifold cover is shown being removed.



20. Disconnect the EVAP line at location shown near the cowl. Push the white plastic button to release.



21. Remove the opposite end of the EVAP line at the solenoid. Push the white plastic button to release. Also unplug the EVAP electrical connection.



22. Remove the PCV hose from the manifold at the arrow location shown. Push the white plastic button on both ends to release.

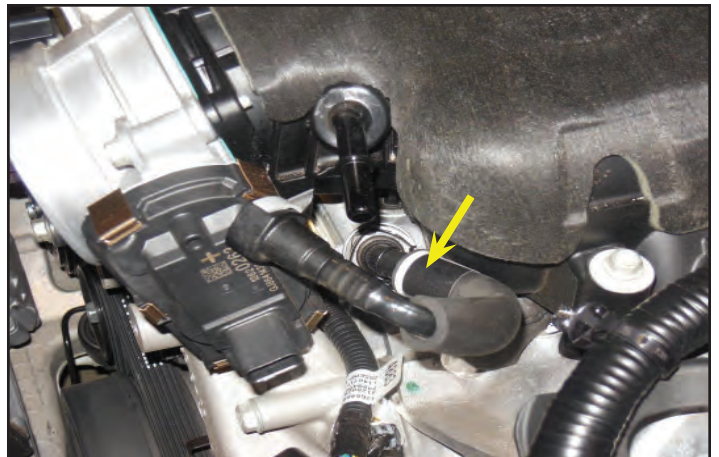

23. Remove manifold bolts (10 each) indicated with arrows using a 10 mm socket wrench. One bolt is hidden from view. Screws are captive, and will stay in place once fully removed. You can use a swivel socket to extract the right side rear fastener that is hidden.

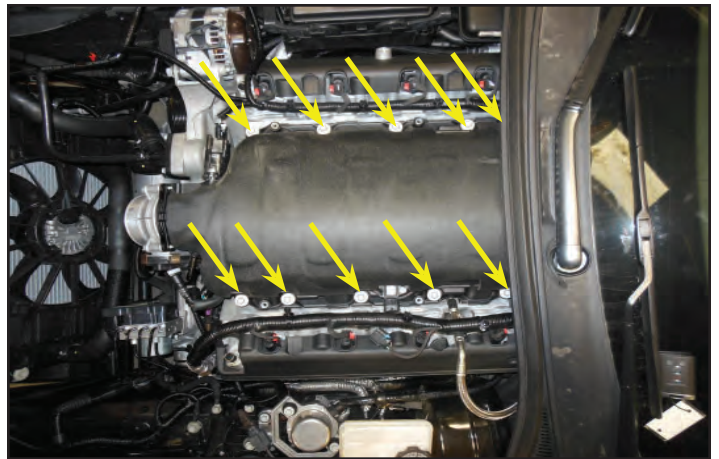

24. Remove the brake booster line at the left rear corner of the manifold. Push in on the red clip, while keeping it pushed in, pull the hardline away from the manifold. It will help to have an assistant hold the manifold forward, and steady.



25. The engine is shown with the manifold removed. Clean intake port areas with a clean dry rag. Then use Simple Green or other appropriate degreaser to clean port surfaces. Vacuum out any debris from the intake ports. Ensure that nothing gets inside the combustion chamber.



26. Use blue tape to cover the ports as shown.



27. Remove the insulation from the manifold valley. This will be not reused. Vacuum out the manifold valley.



28. Disconnect the brake booster line from the vacuum pump.



29. Disconnect the brake booster line from the booster. It may help to use a non-marring pry tool. You may hear a hissing sound while removing this connection. This is normal.



30. Disconnect the brake booster check valve sensor. Pull back then push in on the grey slide tab. Remove the brake booster hose assembly. This will be modified in later steps.



31. Loosen the T30 Torx fasteners (2 each) at the coil covers.



32. Remove the coil cover. Repeat on the opposite side. These coil covers will not be reused.



33. Disconnect the spark plug wires from all the coils. Disconnect the electrical connector on top of the coils. Remove the two screws securing the coils using a 10 mm socket. Set the coils aside for reinstallation later.



34. Once you have removed all the coil packs you can remove the valve covers. Use a 10mm socket wrench to remove the 10 bolts per valve cover. The valve covers will be modified in the next steps.



35. Remove the gaskets from the two valve covers.

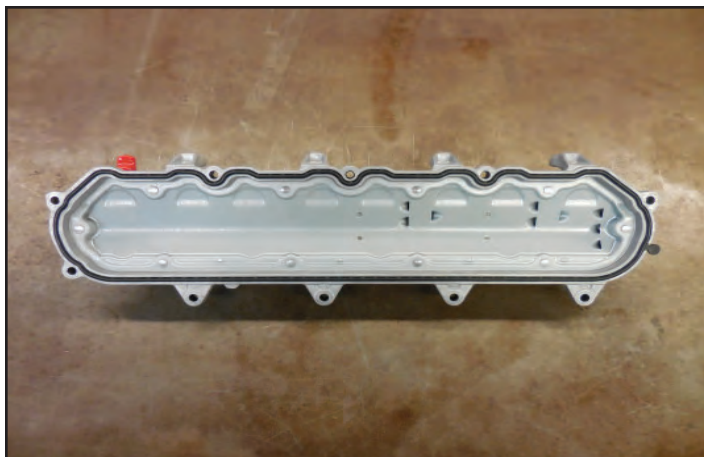

36. There is a tab at the corner that allows you to easily pull this gasket out.



37. Apply masking tape to all the inlets of the valve covers prior to cutting.

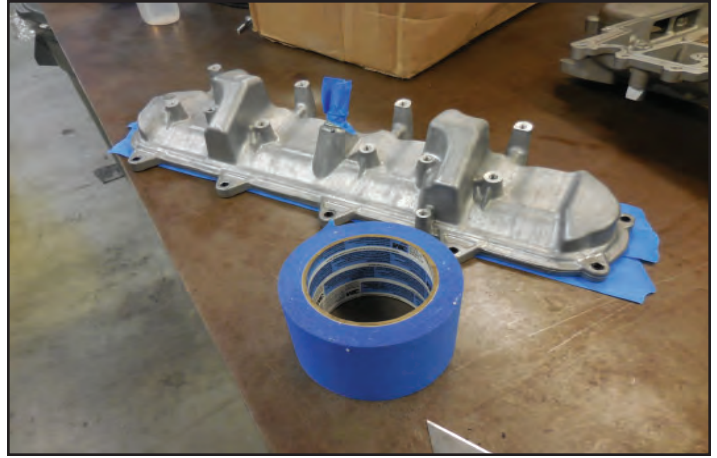

38. Tape the bottom surface as well.

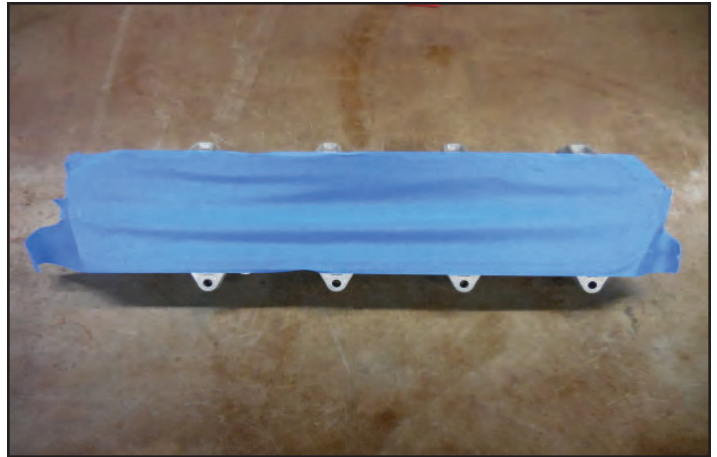

39. Gather the supplied wedges for trimming your valve covers.



40. Place the wedges on the bottom using the bolt holes to secure them in place.

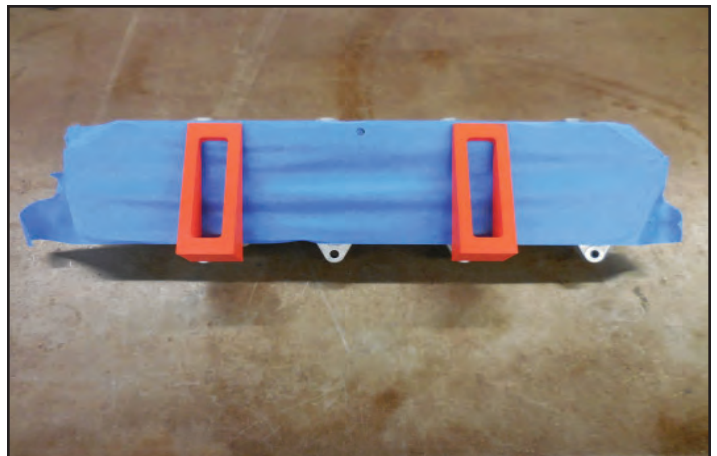

41. Ensure that the wedges sit flat against the bottom of the valve covers, and that they contact the band saw table and guide fence as shown here.

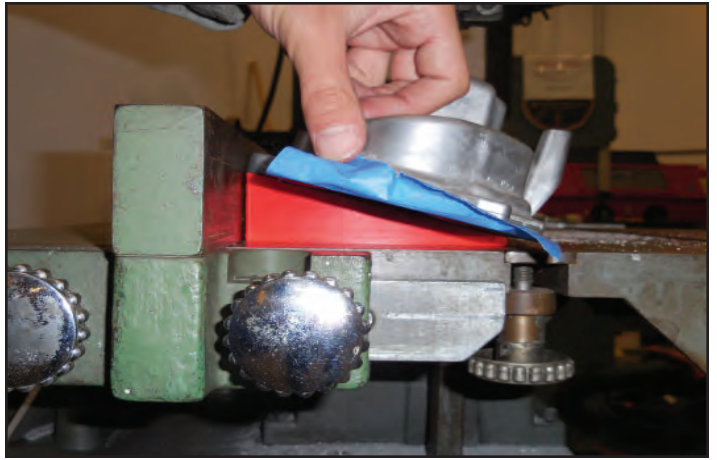

42. Cut each of the top coil pack mounts flush with the valve cover. You will have to stop the saw to reposition the wedges for each cut.

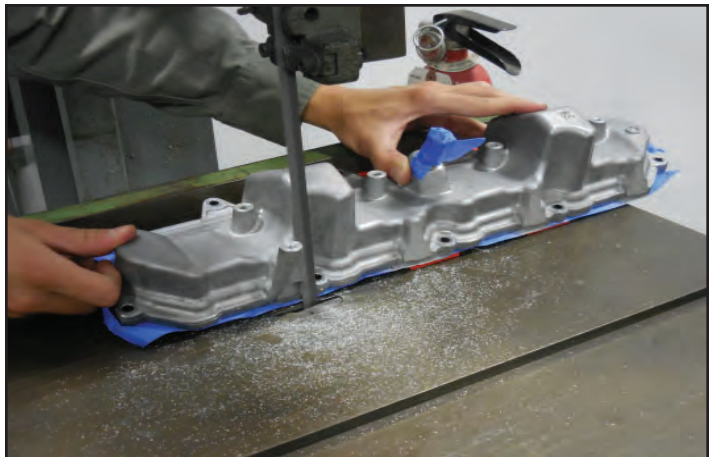

43. Once you have cut the upper coil pack mounts flush you will need to remove any sharp edges. Also thoroughly clean all the debris from the covers once you have removed the sharp edges.

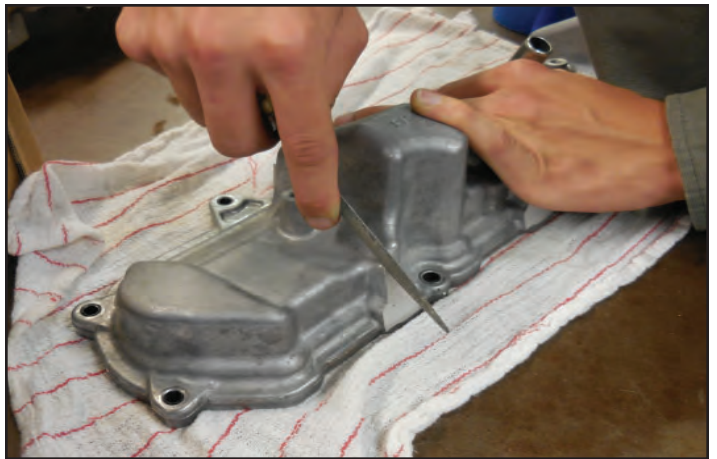

44. Mark the air tube on the passenger side valve cover just past the flare shown at the dashed line location.



45. Use a rotary cutting tool, or hacksaw to cut this airtube past the flare as shown.



46. Here is a photo of the shortened air tube. Deburr the cut edge, and remove the masking tape. **Clean out the debris using a solvent cleaning tank. Ensure that the cover is thoroughly clean and dry before installing them on the heads.**



47. Re-install the gaskets on both valve covers. If you are replacing the spark plugs with new ones, we recommend doing it at this step. Re-install the valve covers on the vehicle as shown below and **torque to 89 in-lbs.**

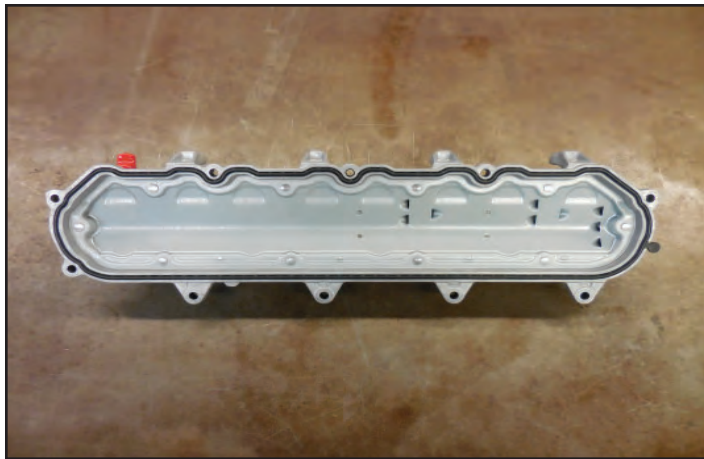

48. Gather the following bracket, nuts and spacers. You will need one set per side.

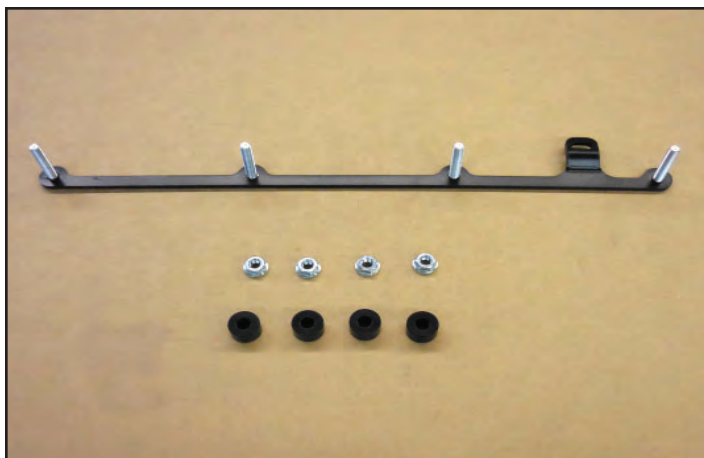

49. Install the spacers on the studs as shown.

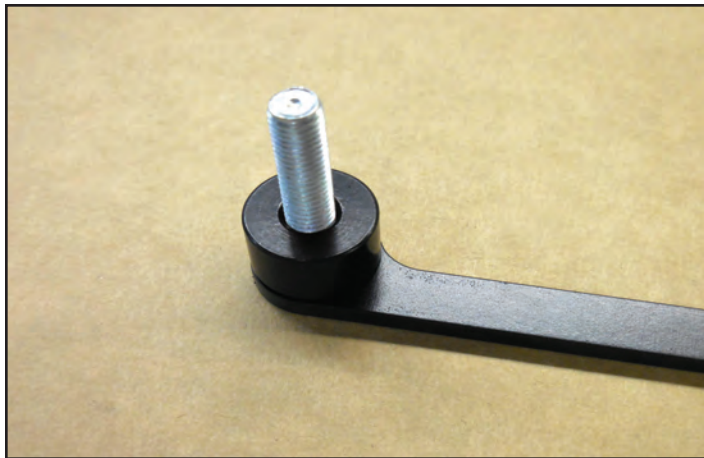

50. Install the coil covers with the supplied lower mount as shown using the provided nuts. Leave these nuts loose until after you have attached the assembly to the valve cover.

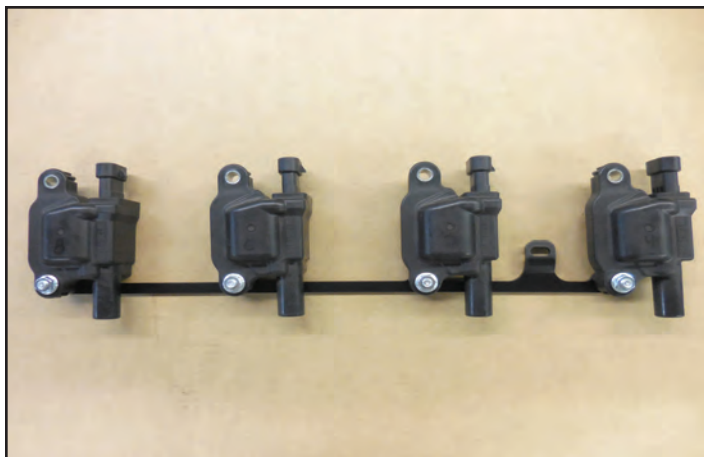

51. Use the OEM bolts at the red arrow locations to install the coils back on the valve covers that were just modified. This will shift the coil packs lower in the engine to give clearance for the supercharger. Install the provided M6x14mm bolt at the yellow arrow location.

Torque the 5 bolt locations shown here and the 4 nuts from the last step to 89 in-lbs.

Repeat this process on the other valve cover. (Image shown with valve cover off of vehicle for clarity)

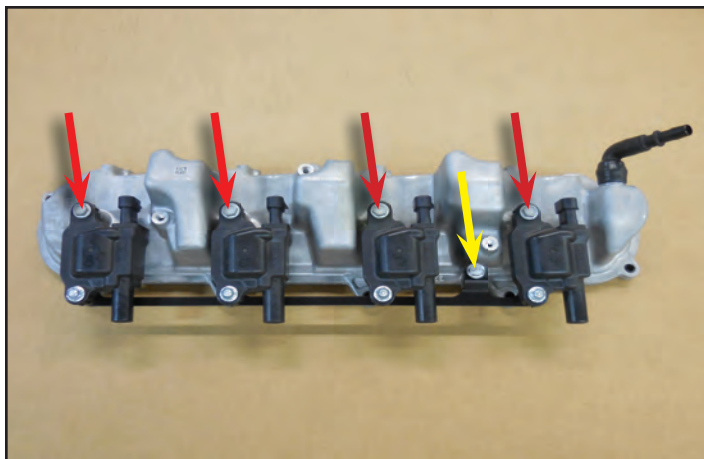

52. Reinstall the valve covers and carefully route the wires out of the way as shown here.



53. Some model years have the connector shown with the arrow. If you have this electrical connector use a prybar to disconnect it from the engine block and then plug it back into the original wiring harness. This photo shows the supercharger installed but this will take place in a later step. This will provide slack for the wiring harness on the left side of the engine after the coil bracket relocation.



54. Remove the four bolts securing the throttle to the factory manifold using a 10 mm socket. Set the throttle and fasteners aside for use later.

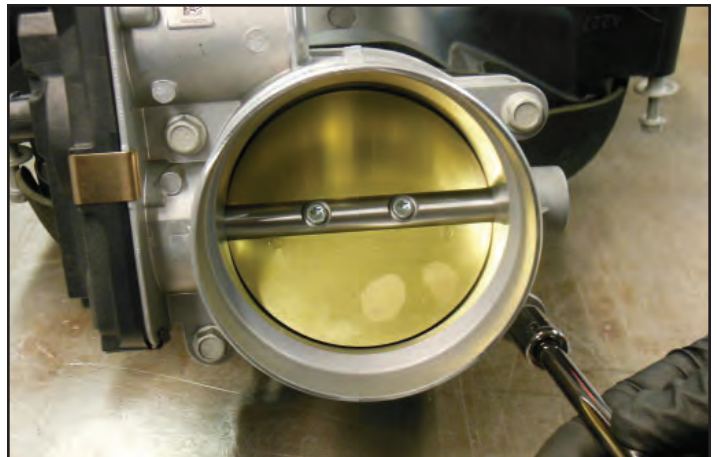

55. Remove the bolt securing the EVAP solenoid using a 10 mm socket. Set the solenoid aside for use in a later step. The bolt will not be reused.



Section 3: **PCV Relocation**

56. Remove the PCV valve using a 24 mm deep well socket and ratchet wrench. This will be relocated to a new position.

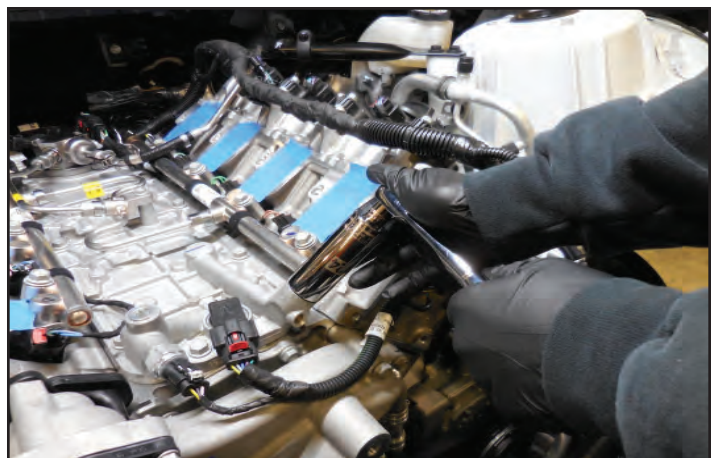

57. Gather the following provided parts. Install the nut with the flanged end facing away from the bolt head. Ensure that the nut is threaded on completely. The spacer will be installed on the bolt in the next step.



58. Slide the spacer over the bolt and thread the bolt into the plug located near the PCV valve that was just removed. Make sure the bolt is properly centered in the plug area, and press inwards as you rotate the bolt clockwise with a ratchet wrench. Continue to tighten until you get three threads or about 1/4" of engagement from the bolt into the plug.

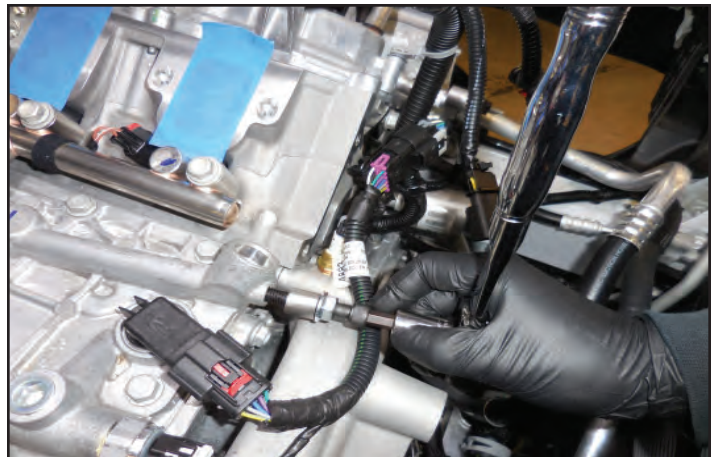

59. Use a heat gun to heat up the area around the plug. Heat for about 45 seconds. This will soften the Loctite and allow you to extract the plug. **Be careful not to melt any wires or plastic connectors.**



60. Once the Loctite has softened you can tighten the nut with a 9/16" wrench. This will pull the plug from the bore. Below is a close-up of the extracted plug.



61. Clean the bore area where the plug was with a cotton swab. After the larger particles have been cleaned out use denatured alcohol, or acetone to clean out the bore thoroughly.

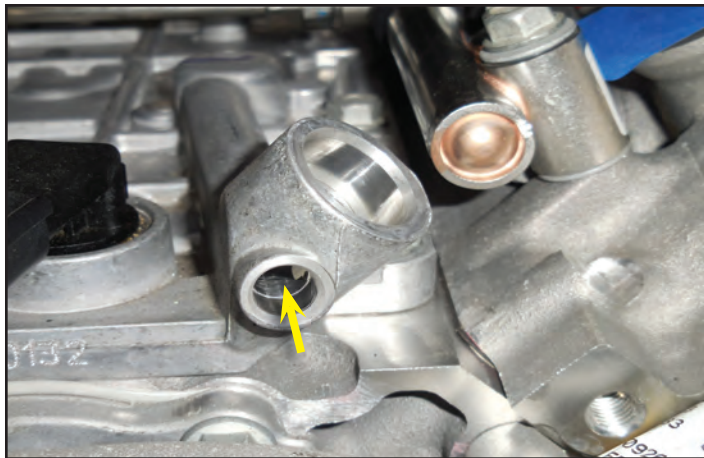

62. Gather the following provided threaded plug.



63. Apply some provided Lubriplate grease to the O-ring of the provided threaded plug that will be installed where the PCV valve was.



64. Use a 6 mm Allen wrench to install the provided threaded plug from the last step in the location where the PCV valve was.



65. Apply a thin bead of the supplied green Loctite 680 to the outside of the supplied PCV relocation fitting in the location shown.



66. Install the supplied PCV relocation fitting in the end of the bore that the plug was removed from and lightly tap it in place with a small hammer until it bottoms out.



67. Re-install the factory PCV valve that was removed earlier. Use an open end wrench to hold the flat sections of the PCV relocation fitting as you tighten the PCV valve with a 24mm deep well socket and ratchet wrench until fully seated. **DO OVERTIGHTEN THE VALVE.**



Section 4: Fuel Line Replacement

68. Remove the fuel safety clips from the fuel line as shown. Use a screwdriver to pry up on the back side of the clip. Then slide the clip out from under the fuel line connection.



69. Remove the fuel safety clip from the other end of the fuel line.

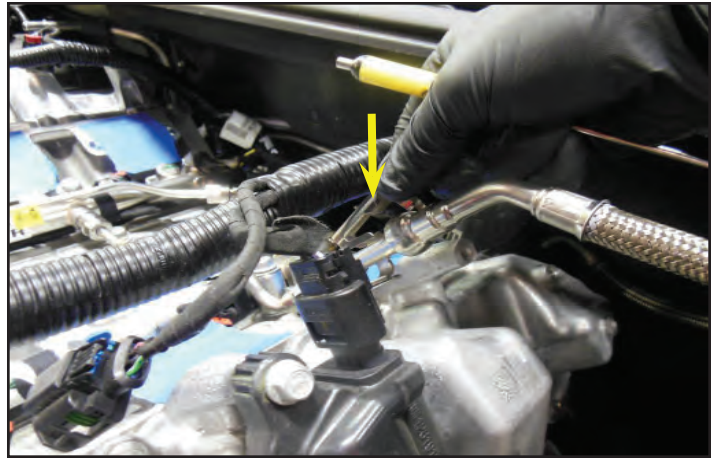

70. Place the plastic tool provided over the fuel line at the location shown. Place rags under the fuel line connection. Push the fuel line in towards the engine. Now pull the plastic tool towards the fuel line. This will disengage the fuel line connection allowing you to pull the line off.



71. Remove the bolt at the fuel line bracket using a 10 mm socket wrench.



72. Use the plastic tool provided to disconnect the opposite side of fuel line. Use the same process as before.



73. Remove the security clip and plastic tether shown from the OEM fuel line for use on the provided fuel line.



74. Use a file to create clearance for the fuel line at the casting location shown with the red arrow. **Ensure that there are no sharp areas present.**



75. **Lightly lubricate the outer leading edge of the male fuel connectors with the provided Lubriplate grease.** Install the provided fuel line by routing it in the location shown highlighted in green. **Ensure that you slide the hose under the hardline shown with the red arrow.** Place one provided Adel clamp in the yellow arrow location to secure the hose. The clamp should not crush the hose. The end connections will be shown in the following steps.

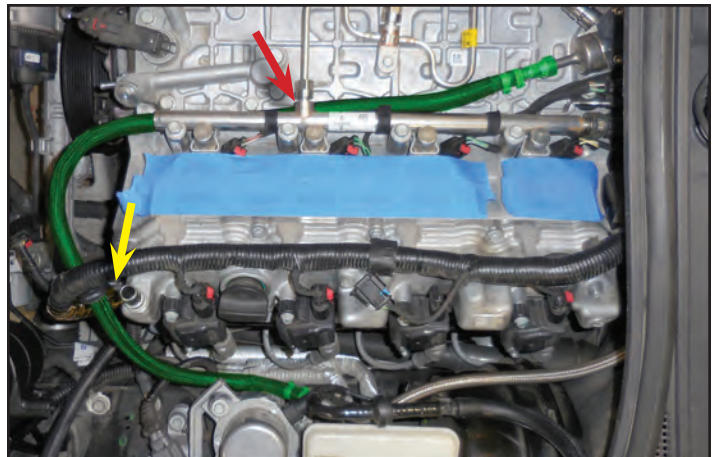

76. **Lightly lubricate the outer leading edge of the male fuel connector with the provided Lubriplate grease.** Install the provided fuel line in the same place as the OEM fuel line. Leave the black plastic release insert shown with the arrow. This can be used to remove the fuel line in the future if needed. **Ensure that you hear a click which indicates that the connection is secure. Pull at the connection to verify it is secure.**



77. **Lightly lubricate the outer leading edge of the male fuel connector with the provided Lubriplate grease.** Install the male end of the provided fuel line to the supply connection where shown. **Ensure that you hear a click which indicates that the connection is secure. Pull at the connection to verify it is secure.** Use the OEM security clip at the red arrow location and tuck the hose assembly under the brake reservoir as shown.



78. Here you can see the Adel clamp in location that was mentioned earlier with the yellow arrow. You will have to adjust the location of the electrical harness shown here with the gold wrap on them to make clearance.



79. Disengage the belt tensioner (Shown Below) using 15 mm socket and breaker bar. Remove serpentine belt.



Section 5: Supercharger Preparation and Installation

80. Remove the 19 M6x20mm bolts around the perimeter of the lid and remove the lid with an 8mm socket wrench. Also remove the four screws holding the Magnuson Supercharger Emblems to gain access the 4 bolt locations that will be fitted with M6x30mm bolts later.



81. Remove the 3 bolts holding the coolant manifold assembly at the front of the supercharger with an H4 socket wrench and pull the spigot out. Repeat this process on the other coolant manifold assembly.

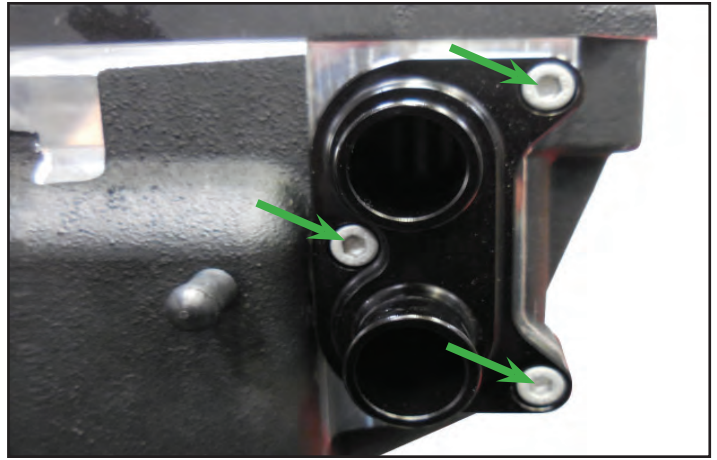

82. Remove the 6 bolts holding the charge air coolers inside the supercharger housing and pull the charge air coolers out. Carefully pull out the charge air coolers by hand. Pull evenly around the perimeter to disengage the seal.



83. Gather the MAP Sensor extension harness shown and release the blue locking tab shown at the blue arrow by sliding it outward.



84. Connect the MAP Sensor Extension Harness from the last step to the MAP sensor on the back on the intake manifold and lock the blue tab. Route the harness as shown in the image to the right to keep it out of the way during the install process.

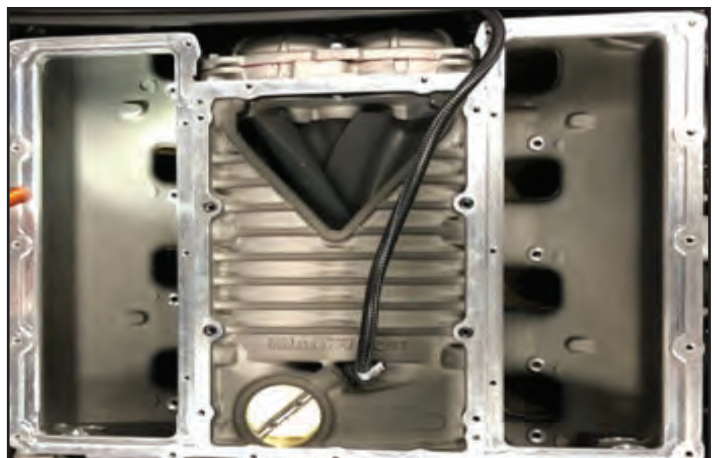

85. **Apply Loctite 242** to the provided three M6x25mm bolts and both sides of the provided stud.



86. Prior to installing the throttle body adaptor make sure that the O-ring is installed in the supercharger housing and throttle body adaptor. Install the stud and nut from the last step at the green arrow location. Ensure that the stud is protruding enough for the nut to have full thread engagement. Install the three M6x25mm bolts from the last step to the throttle body adaptor in the red arrow locations shown (the dashed arrow shows the bolt that is hidden from view) and **torque to 106in-lbs.**



87. Remove the blue tape from the intake ports. Wipe down the intake port outer sealing surfaces with a rag coated with Tri-flow. Pull the coil harnesses to the sides to make clearance for supercharger installation. **Ensure that there are no tools or other items left in the valley area before you install the supercharger.**



88. Install the provided seal washers shown with a blue arrow on 10 provided M6x35mm flange bolts. Once you have slid the washers on all the way to the heads apply a light coat of Lubriplate grease to their undersides. Finally **apply blue Loctite 242** to the ends of these bolts as shown

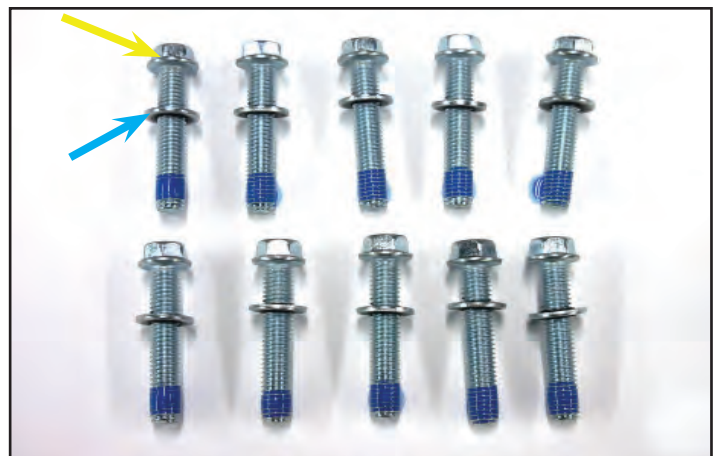

89. Have someone help you locate the supercharger into the manifold valley location. Install the bolts from the last step into the locations listed on the diagram at the back of this book. First finger tighten all bolts. Gradually work your way up to the torque specification listed while you follow the numerical order listed in the diagram. **Make 3 passes, slightly increasing tightening each time. Then make a final pass at 106 in-lbs following the torque sequence at the back of this book. Ensure that the supercharger pulley still spins freely after full torque is applied.**

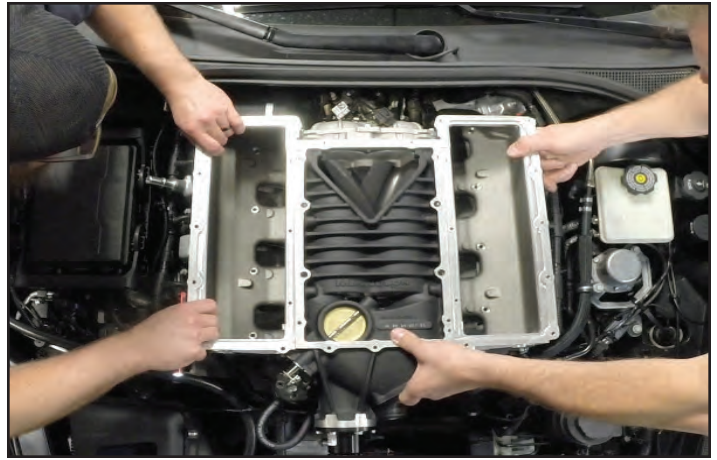

90. Locate the six M5x12mm button head bolts that held the charge air coolers in place. **Apply the provided Loctite 242** on the ends of each bolt.



91. Reinstall the charge air coolers (2 each). Ensure that the port holes match with holes in the housing. Secure with the six M5x12mm button head bolts from the last step in the locations where they were originally.



92. Gather the coolant manifolds shown that were removed earlier. **Relube all the O-rings with the provided Lubriplate grease prior to reinstalling the coolant manifolds.**



93. **Apply Loctite 242** to the six M5x16mm socket head bolts coolant manifold bolts that were removed earlier.



94. Carefully install the coolant manifolds, taking care not to damage the O-rings, with the six M5x16mm socket head bolts from the last step. After you have tightened these 6 bolts go back and tighten the 6 bolts holding the charge air coolers.



95. Install the MAP sensor wiring extension on the OEM plug.



96. Install the opposite side of the wire from the last step onto the MAP sensor at the left rear of the supercharger. Ensure it “clicks” then slide the blue locking tab over.



97. Gather the provided EVAP wire assembly shown.



98. Plug in the connector from the EVAP wire assembly (highlighted in green) to the OEM connector shown with the arrow here at the passenger front valve cover.



99. Route the longer wire from the last step to the opposite side of the engine routing it under the throttle body adapter as shown with the green dashed line. The shorter wire will run in the opposite direction towards the fuse box. Both of these connections will be plugged in later. This photo shows a Z06 Corvette but the routing is the same.



100. Gather the OEM EVAP solenoid that was removed earlier. Replace the OEM bolt on the EVAP solenoid with the provided M6 x 25 mm bolt shown with the green washer in this image.



101. Apply a light coat of Lubriplate grease to the O-ring on the EVAP solenoid.



102. **Install the EVAP solenoid in the location shown and torque to 106 in-lbs.** Also plug in the electrical connection from three steps ago to the EVAP solenoid.



103. Gather the following provided 38" hose with mesh over it, shrink tube, 17mm Oetiker clamp, and fittings. Follow the instructions in the next step for assembly of this EVAP hose.



104. Ensure that the 90° fitting has the white release button. After this you will slide the heat shrink tubing half way over each end of the mesh and the other half over the hose to protect the mesh from fraying. Use a heat gun to shrink the tubing over the ends of the mesh. Slide the 17mm Oetiker clamp over the side where you will put the straight connector. Press the barbed ends of the straight and 90° fitting into the ends of the hose until they bottom out. You may need to heat the hose a little to get the 90° fitting on. Use Oetiker clamp pliers to secure the clamp.



105. Install the EVAP hose assembly from the last step at the point shown with the arrow. Engage the connector lock after you have plugged it in.



106. Attach the opposite side of the provided EVAP hose assembly from the last step at the EVAP solenoid.

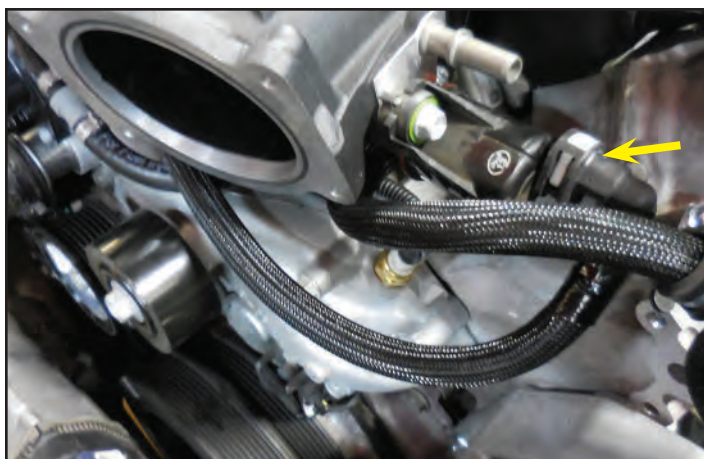

107. Remove 90 degree strain relief cover from the OEM MAF connector.



108. Gather the provided Mass Air Flow (MAF) breakout IAT harness shown below. Install the 90 degree strain relief cover from the last step over the connection shown on the provided MAF breakout IAT harness.



109. Connect the provided MAF breakout IAT harness at the airbox as shown. Ensure that the red lock is engaged.



110. Route the provided MAF harness to the side of the alternator as shown highlighted in green and cable tie it in place at the yellow arrow location. Plug in the MAF wire at the original connector location shown with the red arrow. Ensure that the red lock is engaged once the connection is complete. Continue routing the IAT portion of the harness behind the alternator and towards the supercharger actuator.



111. Route the breakout IAT connection under the supercharger inlet and plug it in where shown with the green arrow.



112. Gather the provided PCV hose assembly shown below and press it onto the factory PCV valve ensuring it locks in place as shown in the photo to the right.



113. Connect the other end of the provided PCV hose from the last step to the 90 degree hose barb shown and firmly secure using the provided Oetiker clamp and provided pliers. The provide pliers are smaller than the ones pictured.

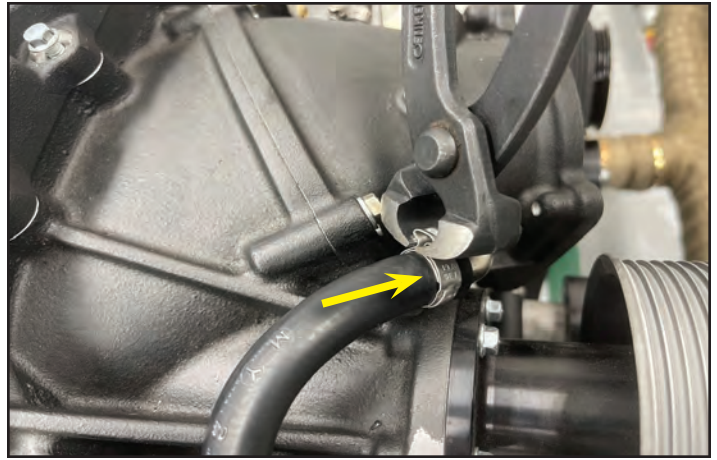

114. Gather the following provided parts. The pump harness bracket with two nuts along with the pump harness are shown. This wiring will provide power to the supercharger's intercooler pump.



115. Remove the nut shown with the arrow from the fuse box base just to the right and behind the alternator.

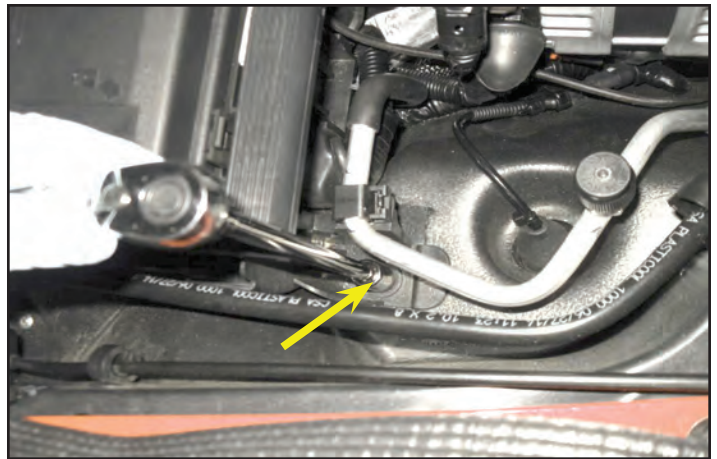

116. Place the pump bracket over the stud and re-install the nut securing the bracket in place.



117. Remove the cover for the fuse location of the provided pump harness, install the provided fuse, and reinstall the cover.



118. Unplug the connector at the alternator. Remove the nut shown with the arrow from the alternator and disconnect the wire.



119. Remove the rubber boot from ring connector on the alternator wire. Overlap the short wire from the pump harness fuse holder over the alternator ring terminal. Slightly offset the two so they sit flush at ring surface. Reinstall the rubber boot over both connectors.



120. Install both ring connectors over the alternator terminal. Reinstall the nut over both ring connectors. Ensure that they both sit flush while tightening. The ring terminal from the pump harness should sit on top of the alternator harness. Cover connection with the boot.

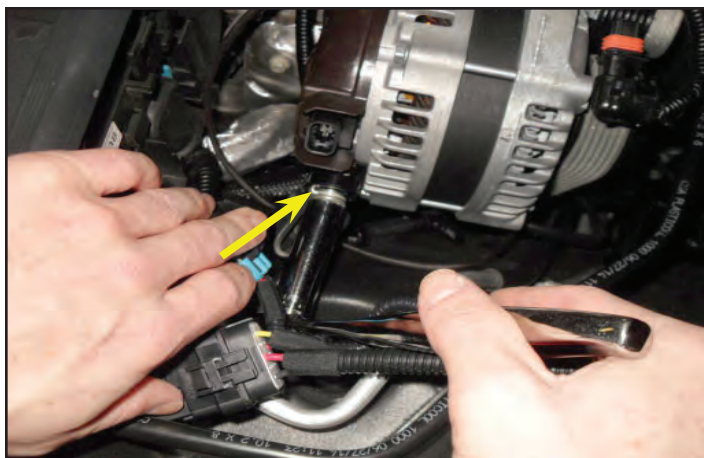

121. Install the relay, and the fuse holder on the pump harness bracket. Secure the relay with a nut using a 10 mm wrench.

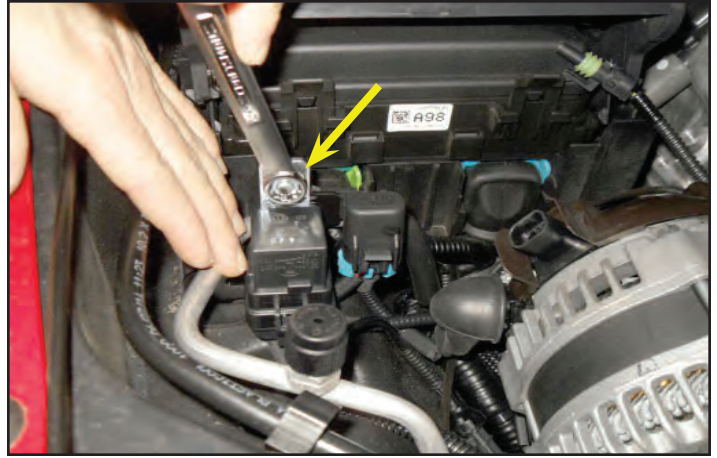

122. Install the nut for the fuse holder at the back side of the bracket as shown using a 10 mm wrench.

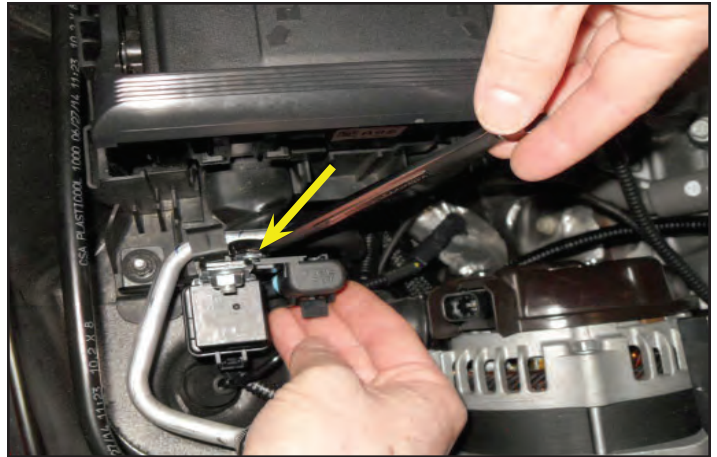

123. Connect the pump relay trigger to the breakout wire from the EVAP harness installed earlier. Re-connect the alternator wire that was unplugged earlier.



124. Install the cable ties (2 each) in the locations shown.



125. Route the pump and ground connection down and forward alongside the alternator. Secure with a cable tie to the A/C hardline.

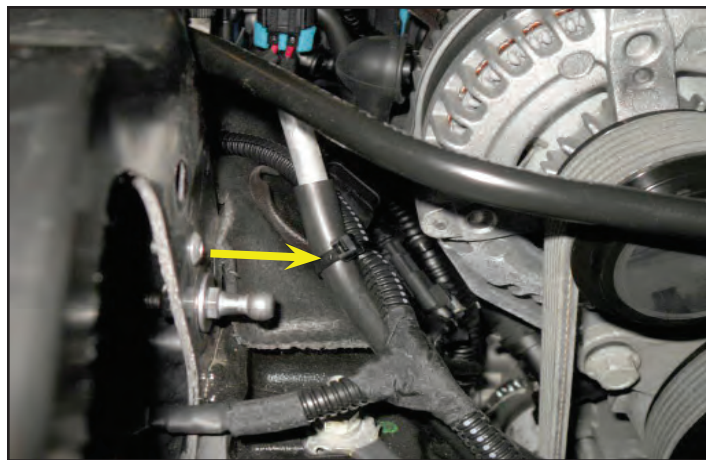

126. Remove the stud/bolt securing a factory ground point in front and right of the alternator. Place the pump ground terminal on top and re-install the stud/bolt.



127. Route the pump wiring harness alongside the A/C hardline. Secure with cable ties making sure that it won't contact the belt.

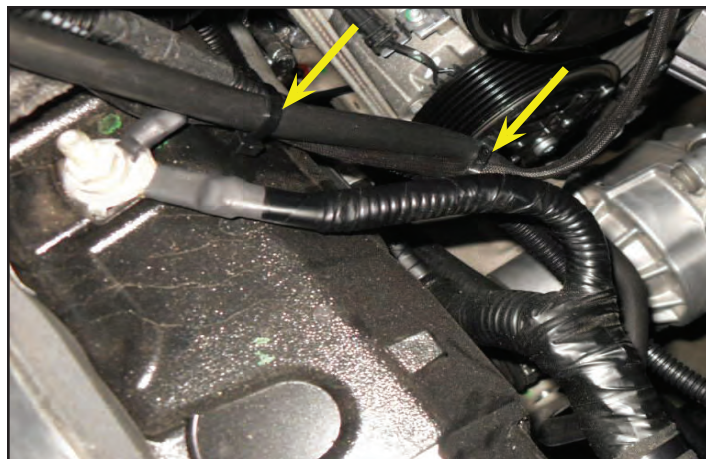

128. Continue routing pump connector forward. Install a cable tie where shown.

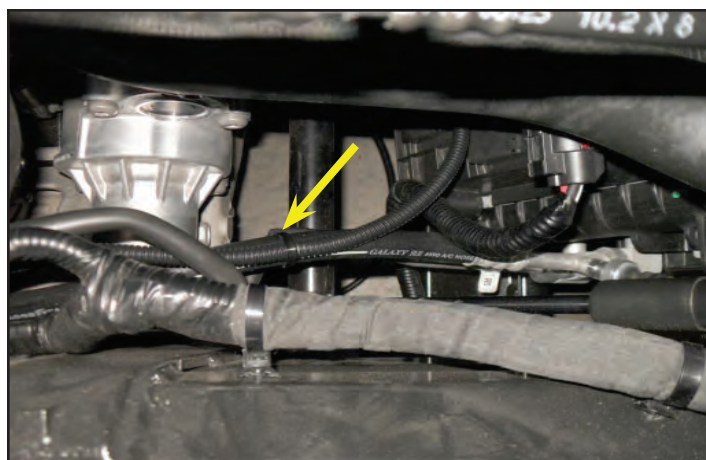

129. This view is from the underside of the vehicle. Remove the two bolts (shown with blue arrows) using a 10 mm socket. Remove the bolts (3 each shown with yellow arrows) with a 10 mm socket. Also remove the button clip (shown with a red arrow). Now remove the cover held in place with the fasteners just removed.

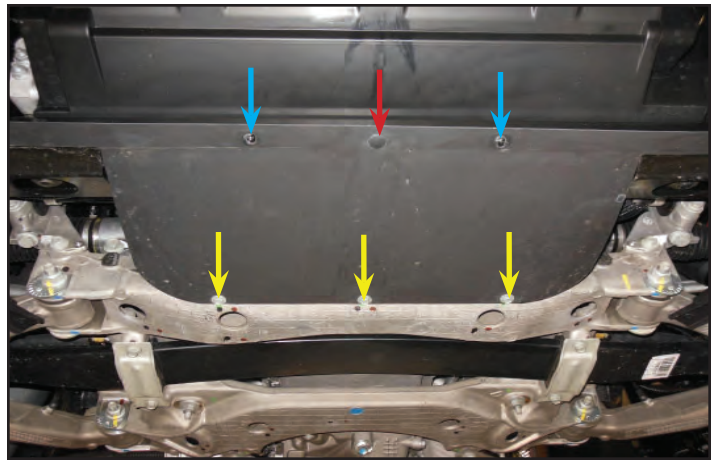

130. View of underside of car with cable tie attachment points (3 each). Use a cable tie with a barbed anchor to attach at the mounting hole on the left side of the radiator fan shroud shown with blue arrow. Secure the harness along the radiator hose with two cable ties at the yellow arrow locations. This harness will connect to the supercharger cooling pump in a later step.

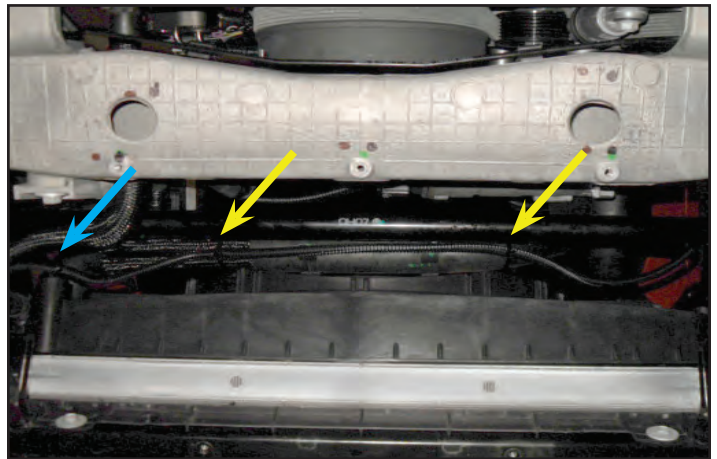

131. Reinstall the throttle body with the factory bolts (4 each). **Torque the throttle body bolts (4 each) to 106 in-lbs.** Install the supercharger pulley at this time as well using the four provided M6x16mm bolts. **Apply Loctite 242 to the pulley bolts (4 each) and torque to 106 in-lbs.** This photo shows the belt installed but this will happen later.

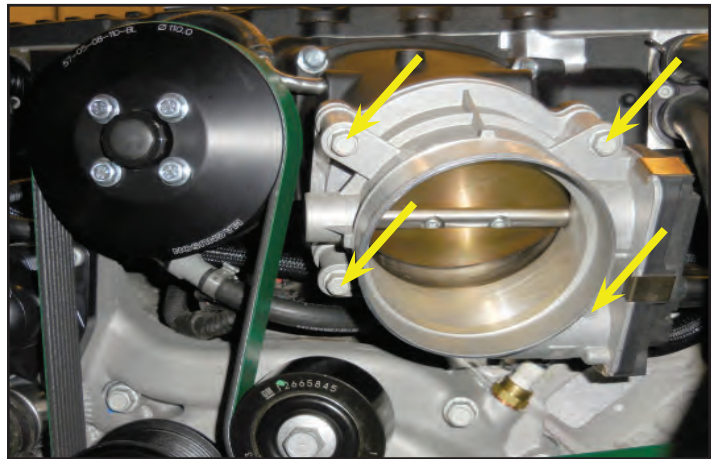

Section 6: Throttle Body, Brake Booster Line, and EVAP Line Installation

132. Plug factory harness into the electronic throttle control, and engage connector lock.



133. Gather the brake booster hose that was removed earlier. This will be modified in the next steps. The hose sections shown in green will be removed.

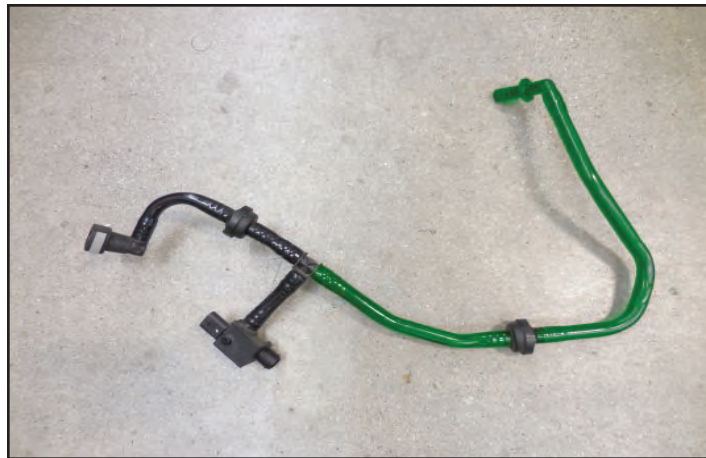

134. Carefully split the hose at the arrow location to remove the hose from the check valve with a knife. **Do not cut into the barbs of the check valve.**



135. Remove the hose that was cut in the last step.



136. **Mark the check valve with a silver dot from a permanent marker on the side shown with the arrow prior to removing it.** Carefully split the hose on the opposite side of the check valve. Remove the check valve. Carefully split the opposite side of this hose at the "T" intersection.

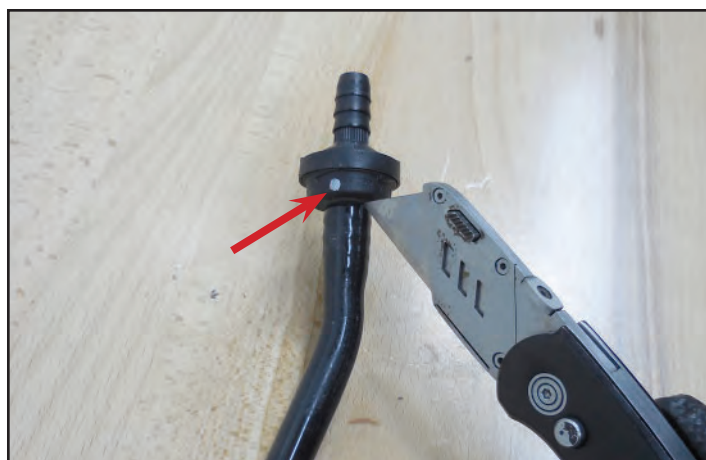

137. Here you can see the hose and check valve removed from the assembly. The check valve will be reused, and the hose will be thrown away.

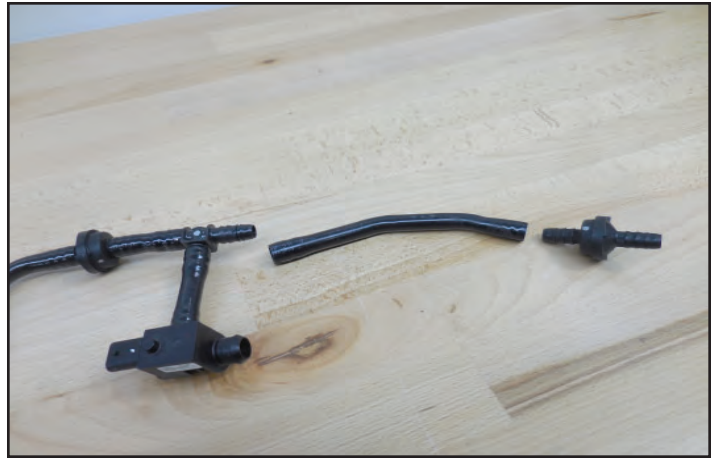

138. Gather the provided 11/32" diameter hose and cut 2 inches from it.



139. Press the two inch section of hose from the last step on the end of the "T" hose barb from two steps ago. Ensure that it bottoms out on the "T". Orient the check valve that was removed earlier with the silver dot (shown with the red arrow) facing towards the 2" section of hose from the last step and press it in place until it bottoms out.



140. Slide the 3/4 diameter x 32" long mesh sleeve on the remaining 29" section of 11/32" hose that was cut earlier.



141. Press the 29" section of 11/32" diameter hose from the last step onto the end of the check valve from two steps ago until it bottoms out.

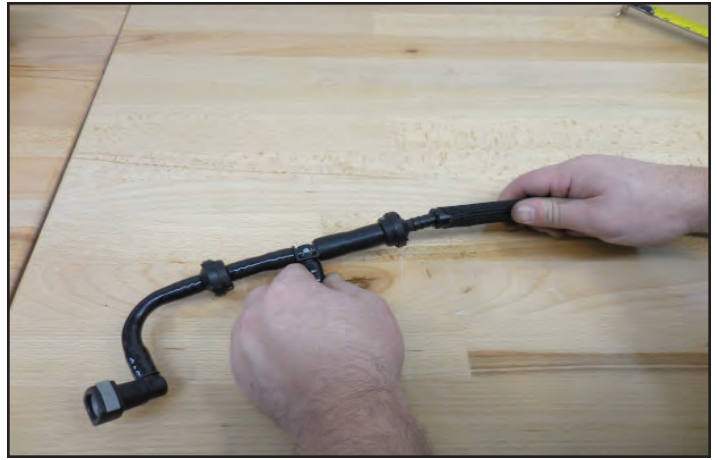

142. Press the provided barbed fitting onto the opposite end of the 29" section of 11/32" diameter hose until it bottoms out.



143. This is the completed modified brake booster hose assembly.

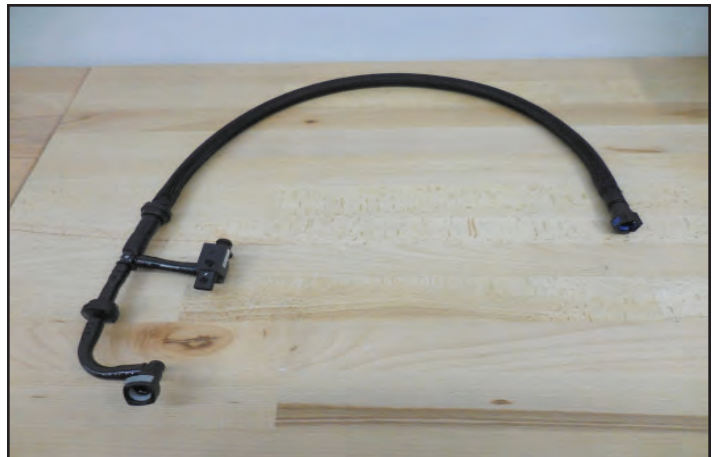

144. Apply a very small amount of Lubriplate grease to the provided brake booster check valve barb.



145. Plug the check valve sensor back into the factory harness at the green arrow location. Insert the check valve into the brake booster canister first (yellow arrow), then install the 90 degree connector on the vacuum pump barb (red arrow).

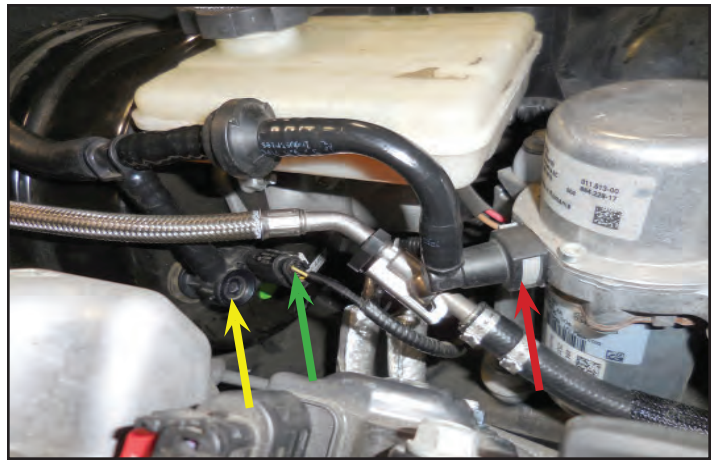

146. Make the final connection of the brake booster line assembly to the air tube on the throttle body adapter at the yellow arrow location. Place three cable ties at the red arrow locations to secure the hose to the electrical harness.

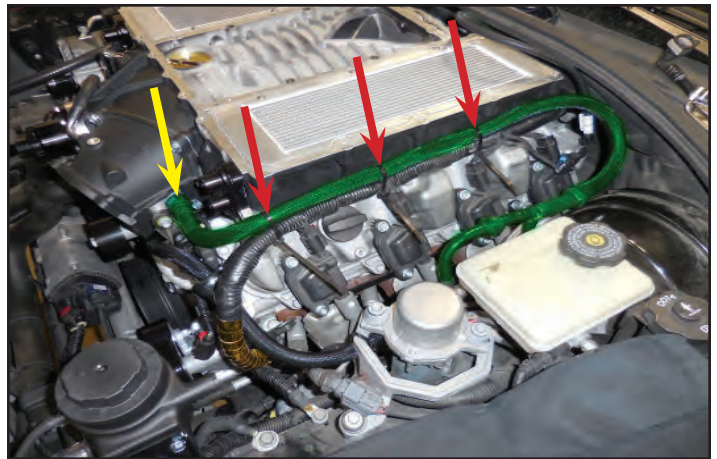

147. Gather the vent hose assembly shown that was removed earlier. Slice the hose highlighted in green at the arrow location to remove it.



148. Gather the provided 5/8"x2"x1.5" 90° PCV elbow, 3/8"x5/8" reducer and 14" long x 5/16" ID PCV hose shown. Insert the 5/8" side of the reducer into the longer 2" side of the PCV elbow. Apply a light coat of Lubriplate grease on the 3/8" side of the reducer and insert it into the 5/16" hose as shown.



149. Press the opposite side of the 14" hose from the last step onto the vent hose assembly at the arrow location.

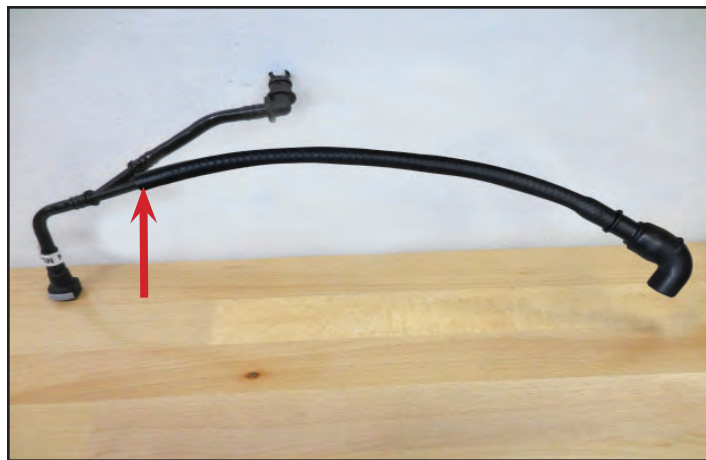

150. Reinstall the hose assembly from the last step at the arrow locations. The 90° hose connection at the yellow arrow location will need a hose clamp which is shown in the next step.



151. Slide the provided 28.6mm Oetiker clamp onto the 90° hose connection. Mount the hose connection on the passenger side valve cover air tube that was modified earlier. Slide the 28.6mm Oetiker clamp down to the end of the hose and secure with Oetiker clamp pliers as shown at the arrow.



152. Secure the EVAP hose (highlighted in green) to the hose assembly installed in the last few steps with a cable tie at the yellow arrow location.



153. **Apply Loctite 242** to the 19 M6x20mm bolts that were removed from the lid and 4 more M6x30mm bolts that were provided and re-install the lid. The four M6x30mm bolts are for the center locations on the lid.



154. Lightly re-install the lid using the bolts from the last step.



155. Zero torque the fasteners first before applying the final torque. **Torque these 23 bolts to 106in-lbs following the order for the lid given at the back of this manual.**



156. Gather the provided Magnuson Supercharged badges and M4x8mm bolts. Application of the adhesive backing from the two provided Magnuson Supercharged badges is optional. **Be aware that these badges will be difficult to remove once the adhesive has been applied.** Install the badges using the provided bolts.



Section 7: Front Fascia Removal

157. Raise the car and remove the front wheels with a 19 mm socket and breaker bar. Remove bolts with a T-15 Torx driver, and the plastic rivets in the location shown. There are a total of 8 fasteners.

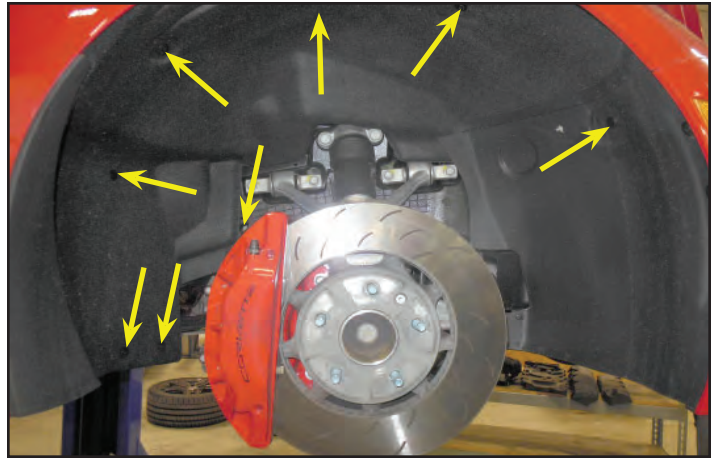

158. Remove the three bolts shown with a T-15 Torx driver.



159. Remove the bolt using a T-15 driver at the green arrow location. Use a plastic pry bar to remove the fastener shown, and all others like it. Pry the inner portion of the button out first to unlock, then pry on outer portion of button.



160. Remove the 2 bolts shown at the top of the photo with a 7 mm socket. Also remove the bolt shown at the bottom with a 10 mm socket. Picture shows area underneath the front wheel.



161. Grand Sport models will need to remove the 3 bolts holding the air curtain at the three arrow locations that have also been highlighted in green.

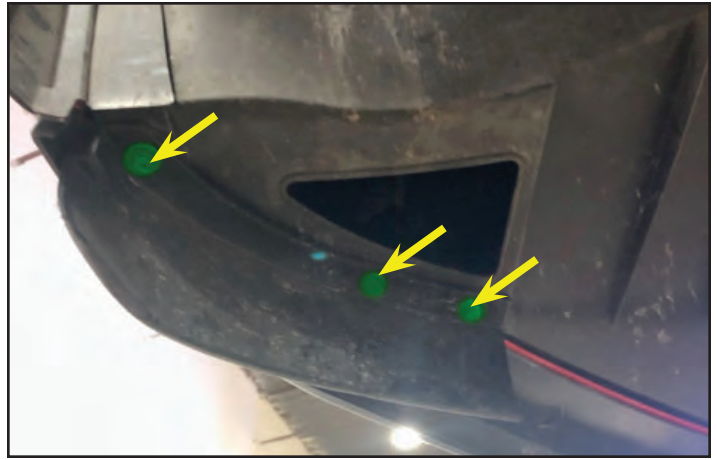

162. Remove bolts (4 each) shown at the top with a 7 mm socket. Also remove the silver bolt shown to the left with a 10 mm socket.



163. If equipped with side splitters (Grand Sport), drill out the rivet shown. This is an assembly aid and is not required to be re install.



164. Remove the bolt shown with an arrow using a 10 mm socket. Bolt is located behind the front wheel underneath the vehicle.



165. Pull the trim piece out at the back of the wheel well. Grand Sport models will need to remove 3 Torx #15 bolts shown with arrows in the image below before removing the trim piece.



166. Non Grand Sport models will require the removal of the fasteners shown with arrows in the image to the right.

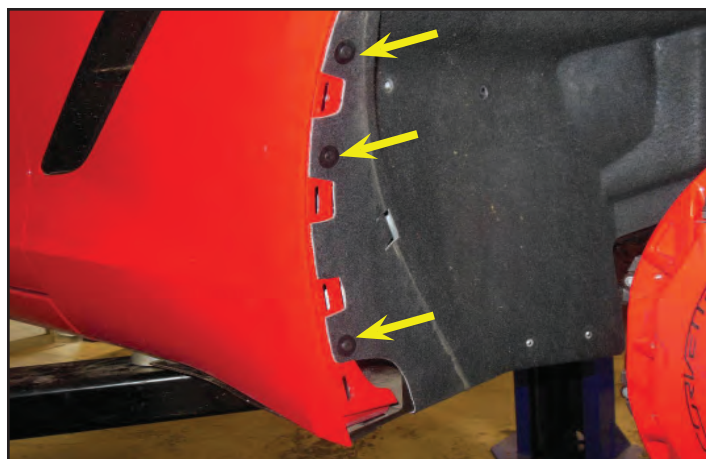

167. Pull around all edges of wheel well cover to remove it.



168. Wheel well cover shown being removed. Repeat the process from the last few steps to remove the left side wheel well cover.



169. Remove black bolts (6 each) with a 7 mm socket and silver bolts (4 each) with a 10 mm socket where indicated. Once the last bolt is removed the lower panel will drop. Make sure to support it during the process.

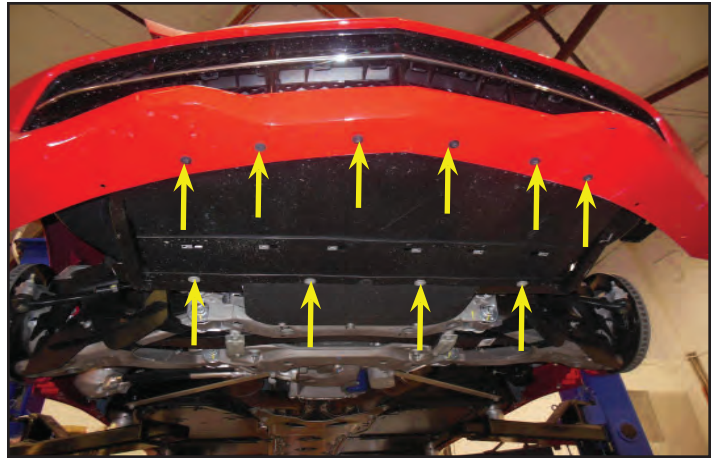

170. Cover from last step being removed.



171. Remove radiator duct fasteners (5 each) located under the cover just removed with a 7 mm socket.

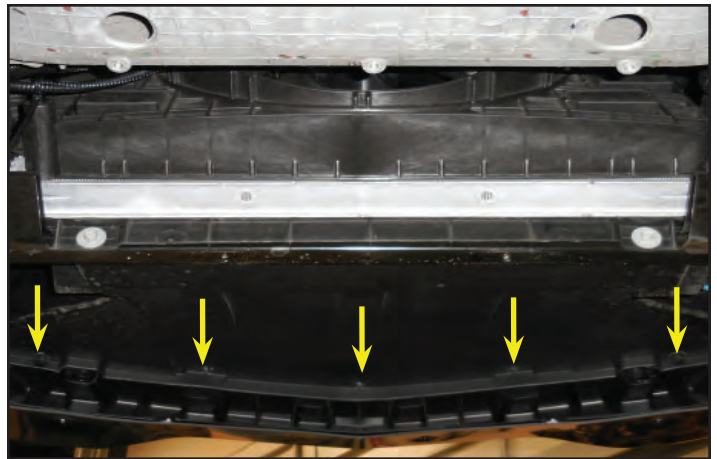

172. Remove the side marker connection. Pull the grey tab and then pull the connector.



173. Place tape over area shown to protect paint. Pull the side of the front fascia near the headlight to disengage. The left side is shown. Repeat this step on the right side.



174. Remove the bolts (2 each) with a T-30 bit, and button rivet (2 each) where indicated.

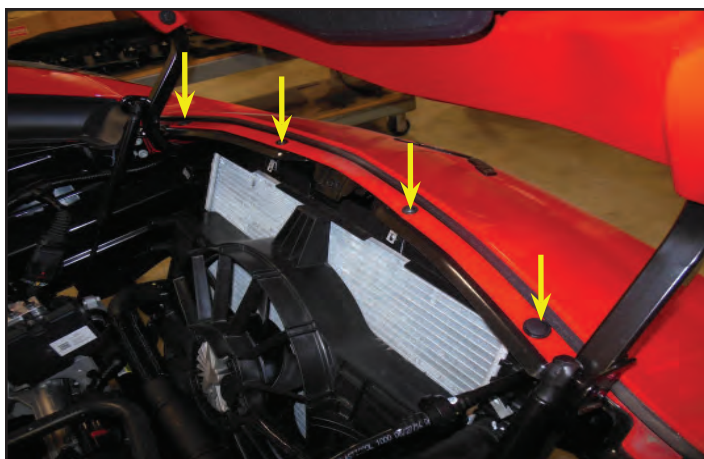

175. Remove the covers near the hood hinges (1 per side).



176. Remove the fasteners (1 per side) that are under the covers from the previous step with a T30 driver.



177. Use a plastic pry tool if necessary to start pulling up on the fascia near the hood hinges. Work your way along the seam to the headlight. Pull firmly to disengage the fascia but be careful not to damage the paint. If this does not work move on to the next step. Repeat on right side.



178. Have someone else help by pulling up slightly on the fascia away from the vehicle to allow access for a 1/4" drive extension with a 7 mm swivel socket to loosen the two bolts on the bracket near the headlight. This bracket is shown in a few steps for reference. Apply blue tape to the body panels near the connection to prevent scratching. Repeat on right side.



179. This view shows one of the two bolts being loosened. Once the bracket is loose it should be easier to pull and disengage the fascia. Repeat on right side.



180. The front fascia is shown with the connections disengaged. Remove fascia carefully and store in a safe location.



181. The retainer bracket near the headlight is shown that may have been loosened in a previous step. This is shown for reference to understand where the bolts are that need to be loosened.



Section 8: Crank Pulley Replacement

182. You will need to prop the hood open with a suitable rod while you remove the gas support struts. There are two of these located at the hood hinges and the top of the sway bar mounts. This will allow you to slide the sway bar and the steering rack forwards to remove the crank pulley.



183. Secure the steering wheel in place using a suitable device. **Failure to secure the steering wheel and keeping the front tires from moving could result in damaging the SIR coil.**



184. Unbolt the intermediate steering shaft at the location shown with the arrow using an 11mm socket wrench.

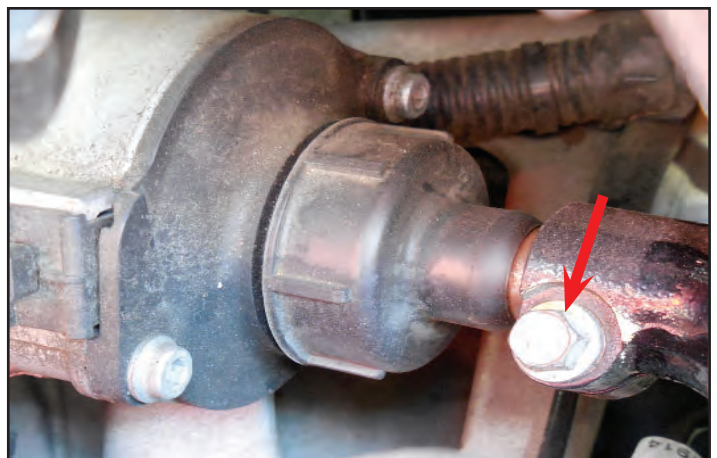

185. Unplug the connections shown with the arrows on the power steering module.

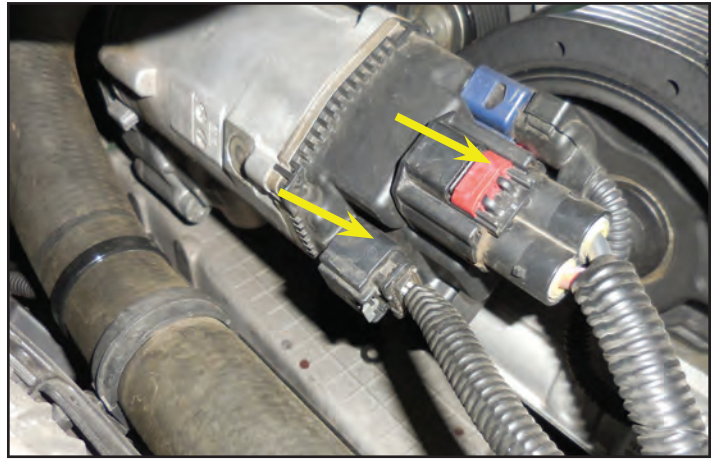

186. Disconnect the brake control harness, and the chassis harness at the locations shown with arrows.

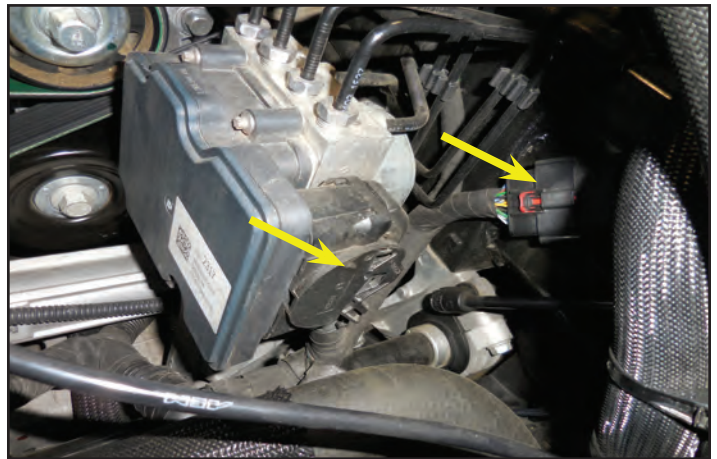

187. Remove the two nuts shown securing the brake control module with a 10 mm wrench. One is shown here with an arrow, and the other is on the back underside.

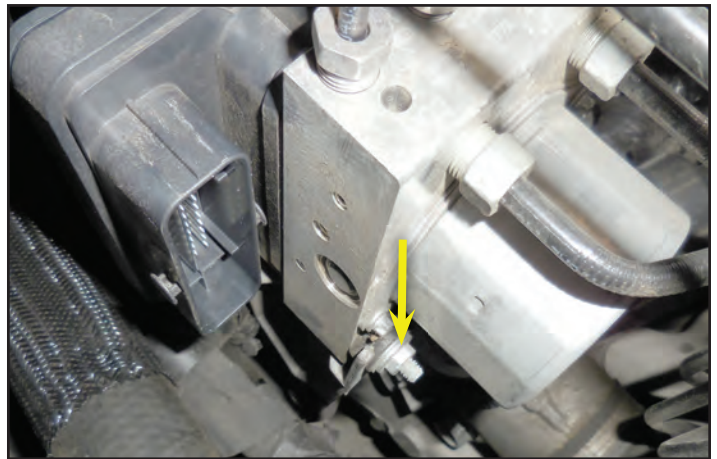

188. On Grand Sport models remove the brake cooler ducts on the lower control arms using a T15 Torx bit at the arrow locations shown in the image to the right and below (Both sides of the vehicle).

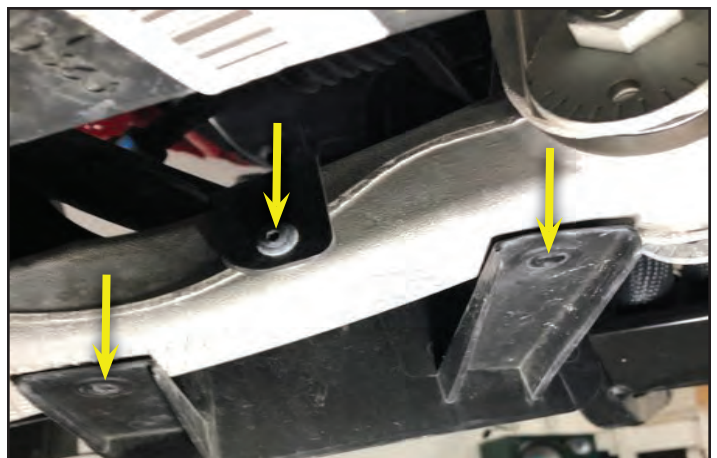

189. Remove the two bolts shown with red arrows from the right side sway bar mount. Remove the bolt shown with the green arrow which secures the steering rack. These bolts will require an 18mm and 15mm socket wrench.

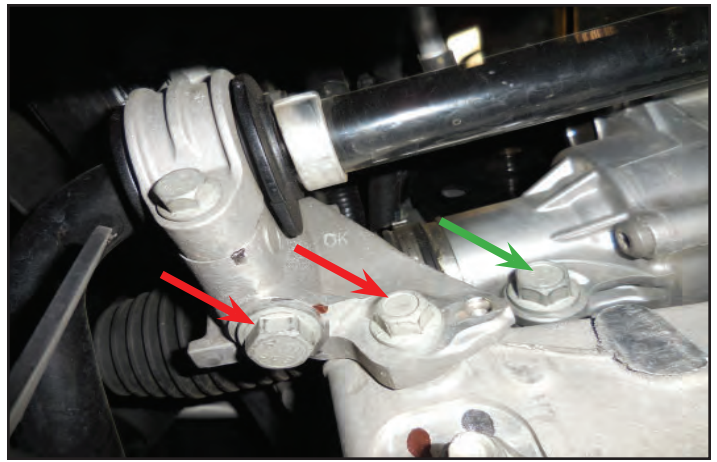

190. Remove the two bolts shown with red arrows from the left side sway bar mount. You should be able to rotate the sway bar assembly away to access the bolts for the steering rack assembly. Remove the bolt shown with the green arrow which secures the steering rack.

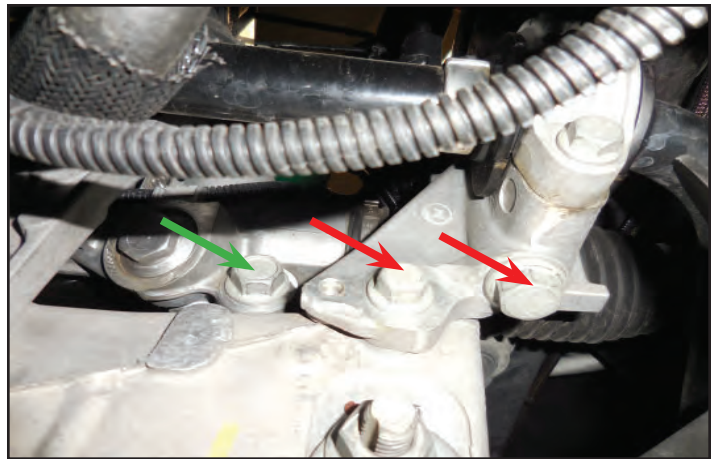

191. Remove the two bolts shown with red arrows holding the brake control module. Also remove the plastic rivet holding the wiring harness in the location shown with the green arrow. Remove bracket from vehicle to gain more clearance.

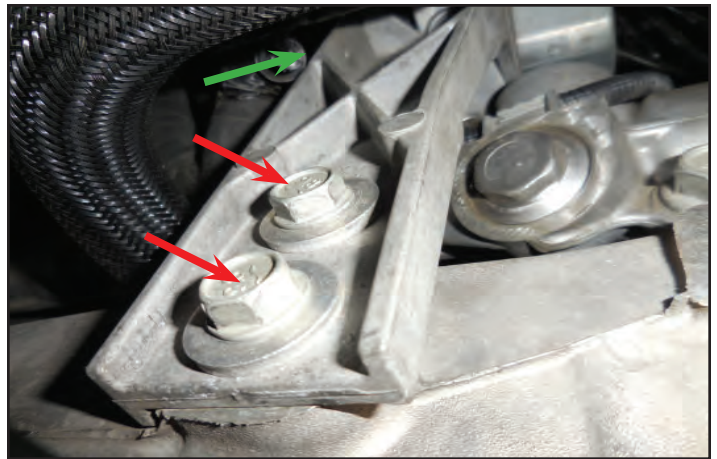

192. Remove the two nuts securing the ends of the front sway bar by holding the nut with an 18mm open end wrench while turning the center bolt with an 8mm socket wrench. The left side of the sway bar is shown here. At this point you should be able to slide the rack forward and secure it with some cable ties.



193. Remove the crank pulley bolt using a 24 mm impact socket and an impact gun. You may have to heat the bolt with a heat gun or torch to soften the locking chemicals prior to removal with impact gun. You may need to lock the flywheel in order to prevent the engine from turning over. Note: The images shown for the crank pulley are for our LT1 Camaro kit, but the process is the same.



194. Install a three jaw puller to the pulley for removal. It is recommended to use a GM specific puller for this operation.



195. After the pulley is removed check the seal for any damage.



196. Gather the provided pulley and the new bolt. **Do not use the original bolt!**



197. Apply motor oil to the inner bore and the outer seal surface of the pulley shown with arrows.



198. Apply motor oil to the crank seal.

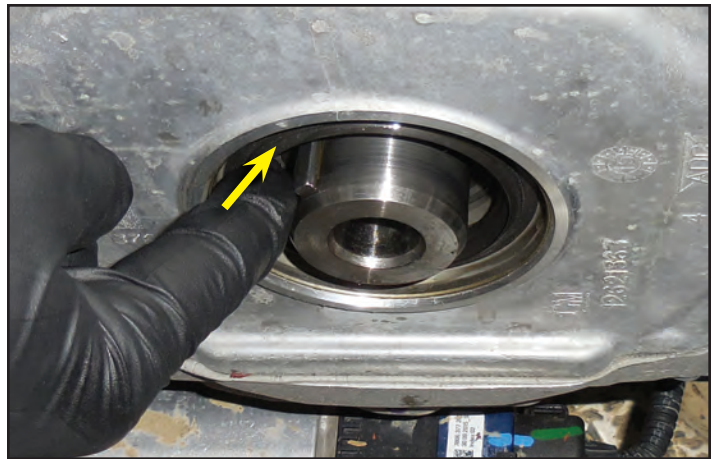

199. Install the provided pulley. Take note of the key way position on the crank, and line the provided pulley up with it.



200. Use a pulley installer tool to tighten the provided pulley in place. **Do Not use the provided bolt to install the pulley.** You may need to remove your starter and install a flywheel locking tool in order to properly torque your pulley in place. Once the pulley has been fully seated with the pulley installer tool install the old crank bolt that was removed from the original pulley. **Torque this bolt to 240 ft-lbs.** Discard the old bolt once this step is done.



201. Once the last step has been performed use a 24 mm socket to install the **new provided** crank pulley bolt according to the following GM specifications. **First torque the provided bolt to 111 ft-lbs. Then loosen the bolt 360 degrees. Now torque the bolt to 59 ft-lbs. Then tighten an additional 125° using a torque angle meter.**

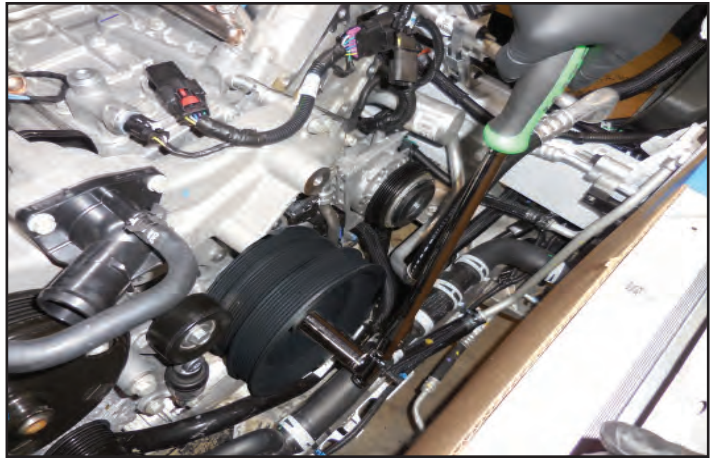

Section 9: Tensioner Assembly, and EVAP Solenoid Installation

202. Remove the ground retainer strap bolts shown with a 15mm socket wrench. This is located below the Adel clamp that was installed on the fuel line at the driver's side valve cover. This will not be reused.



203. Gather the provided bracket and bolts shown. **Apply Loctite 242 to the bolt threads as shown.** The single M8x50mm bolt will go in the green arrow location. The two M8x35mm bolts will go in the blue arrow locations. The two M10x75mm bolts will go in the red arrow locations.

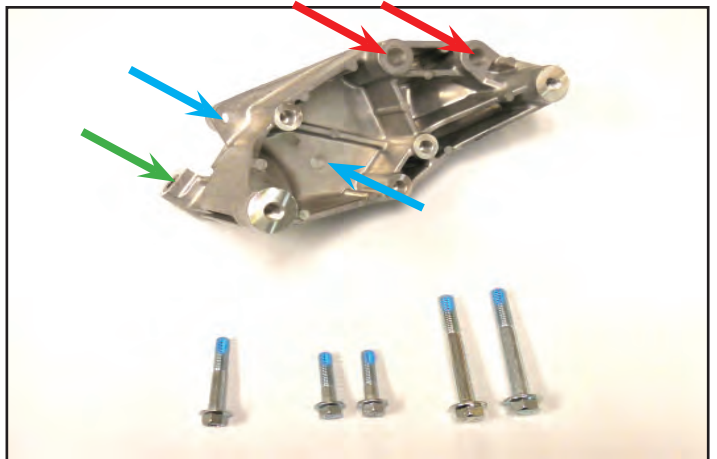

204. **Note: Idler pulleys shown in this photo will be installed in a later step.** Install the provided bracket from the last step with the provided bolts in the locations described in the last step. **Torque the M10 bolts to 25 ft-lbs and the M8 bolts to 18 ft-lbs.**

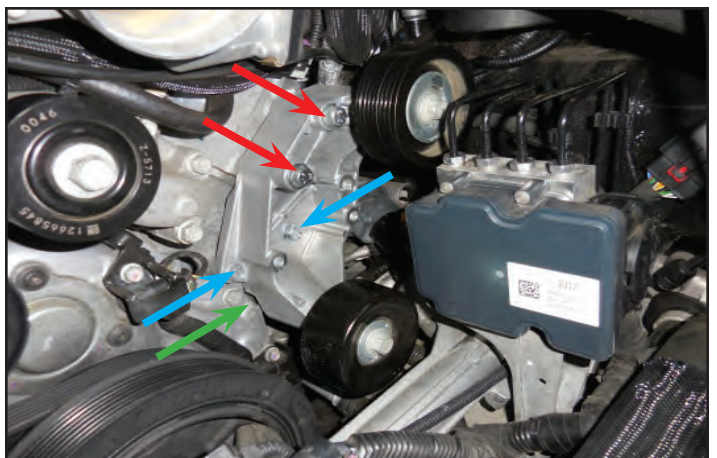

205. **This photo is shown with the bracket out of the vehicle for clarity. Apply Loctite 242 to the threads on the remaining three provided M8x50mm bolts.** Install the provided tensioner shown to the bracket installed in the last step using the three provided M8x50mm bolts shown with red arrows in this photo. **Torque the three M8x50mm bolts to 18 ft-lbs.**

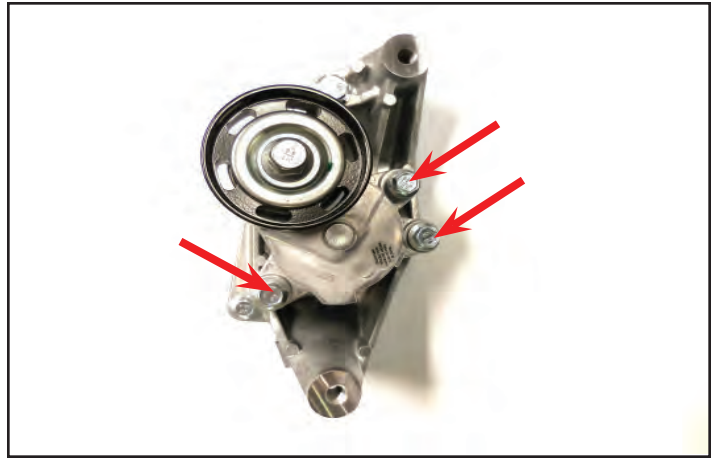

206. **Apply Loctite 242 to the bolt threads of the following idlers prior to installing.** Install the provided idlers in the locations indicated as follows: 70mm ribbed at red arrow, 68mm smooth idler at blue arrow, 88mm ribbed at yellow arrow, and 90mm smooth at green arrow. **Torque all four idlers to 25 ft-lbs.**

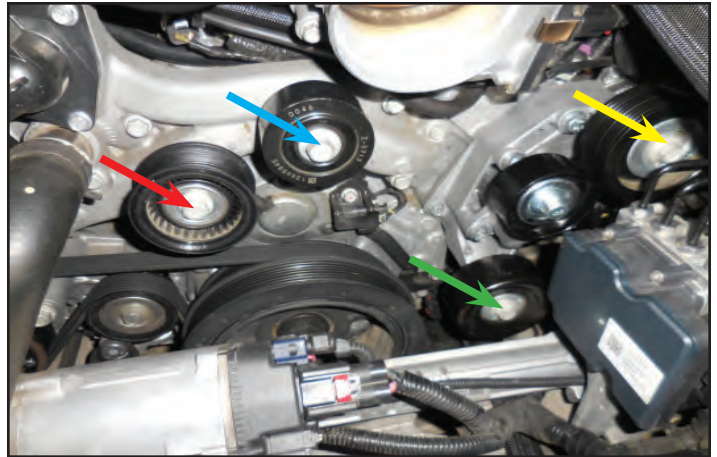

207. Reinstall the factory belt using the diagram at the back of this manual.



208. **Refer to the secondary belt routing diagram at the back of this manual.** Install the provided supercharger belt on all the pulleys except the 68mm smooth idler. Then rotate the tensioner counter-clockwise (shown with a yellow arrow) using a 15mm socket and serpentine belt wrench. The serpentine belt wrench is a flat bar designed to give more clearance in tight areas. Then slip the belt under the 68mm smooth idler pulley. You may need help from someone for this step.



209. Here is a photo of the belt in its correct location.

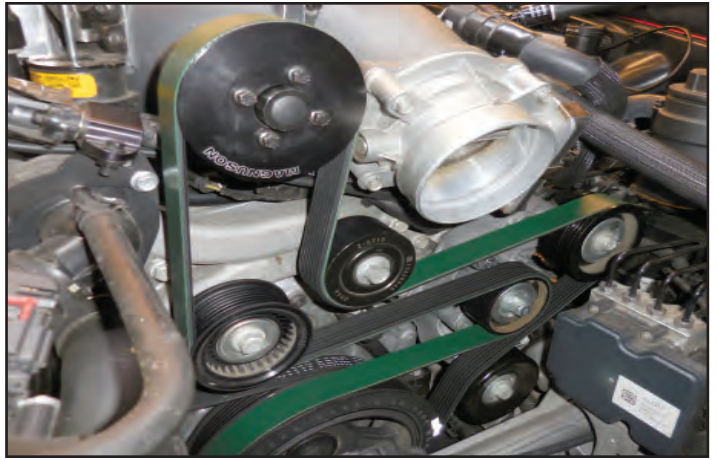

210. Reconnect the brake control module, sway bar, steering rack, brake control harness, chassis harness, power steering module, and intermediate steering shaft following the directions at the beginning of this section in reverse order. **Torque all locations to factory specifications.**

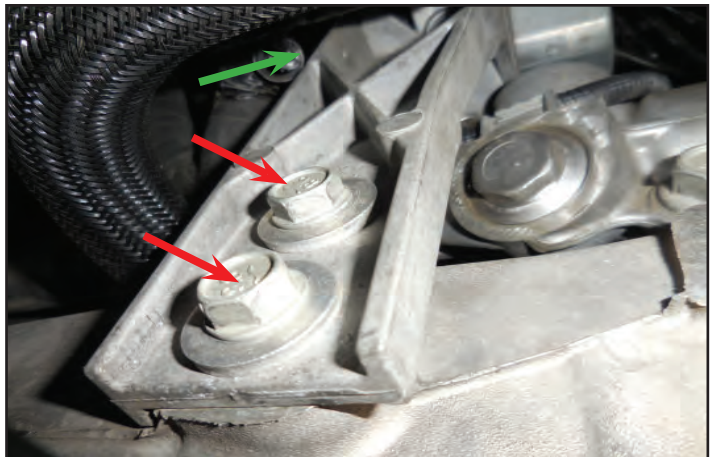

Section 10: Low Temperature Radiator (LTR) Installation

211. Use the LTR upper bracket hole template provided to locate the center for the hole at center radiator support near the front of the car. Align template along the edge of the ribs as shown. Use a center punch to transfer the center location to the plastic below.



212. Drill the support area to the size indicated on the template. Ease up pressure before breaking through. Use a hole saw to drill the hole.



213. Take the LTR vent hole template and install it on the upper driver's side as shown closest to the left fastener (shown with arrow). Center punch at the center line.

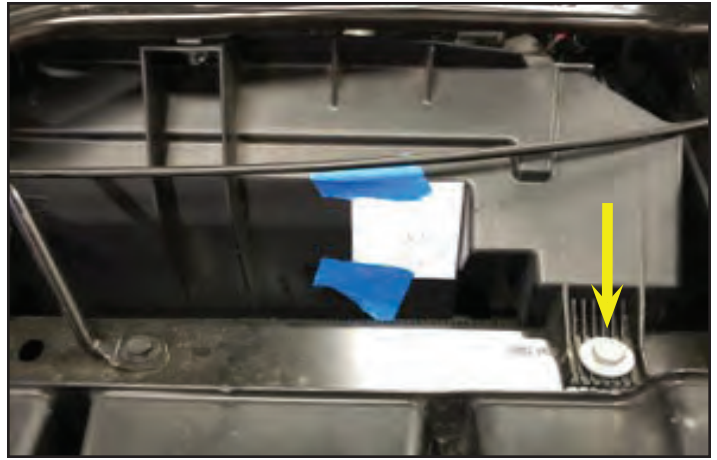

214. Drill the hole out to size shown on the template. Ease up pressure before breaking through. A Rotabroach tool is shown which can help limit the depth of tool after break through. This can help avoid damaging anything that is below the plastic.



215. Grand sport models will need to remove the driver's side brake duct to gain more access. Remove the 2 bolts holding the duct on. (10 mm socket) This will be re-installed at a later step.

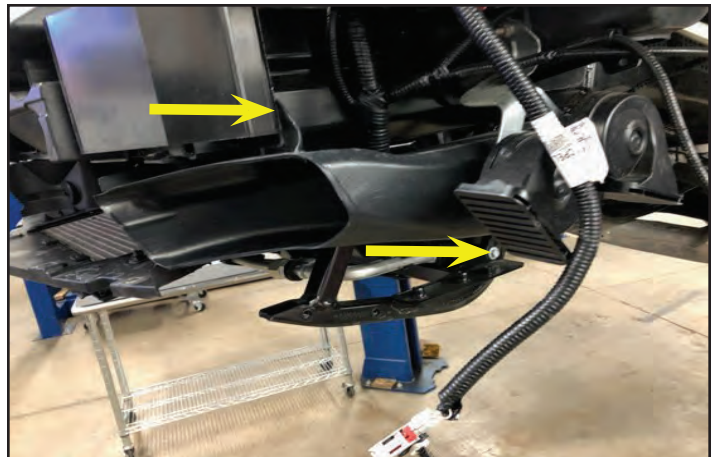

216. You may have to remove some items like the brake air duct to gain better access to this area. Place the LTR spigot hole template on the left side of radiator duct. The template is designed to nest within the radiator duct's pocket. Make sure the "UP" marking is oriented correctly. Line up the edges of the template with the front and bottom edges of the plastic molding. Center punch both hole centers.



217. Drill the pilot hole for the hole saw at the center locations from the last step. Example: Drill a 1/4" hole at each location first. This will help to locate the hole-saw for final drilling. Drill the holes to the size indicated on template with hole-saw. Ease up pressure on the drill prior to breaking through. Deburr holes after drilling.



218. Tape the template shown in the location under car near the steel radiator support. Follow the instructions of the template to properly line it up with the cross support. Center punch the holes (2 each) at the center lines. The locations of the holes are shown with arrows.

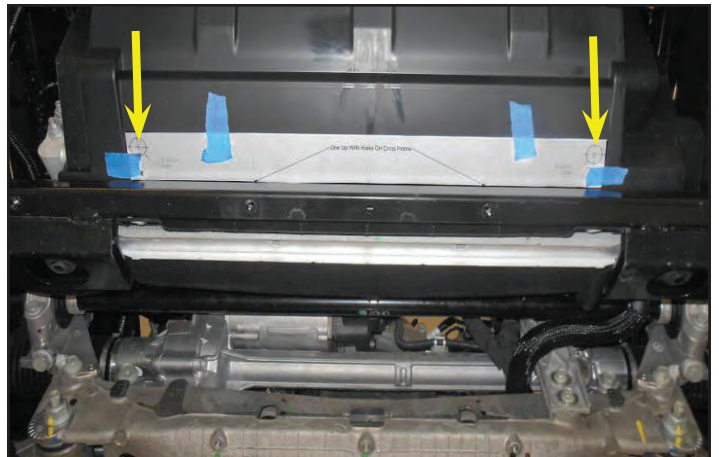

219. Drill the holes to the size given on the template. Ease up pressure on the drill prior to breaking through. The condenser is located near this area so extra care is needed. Deburr the edges of the holes.



220. Remove the bolts (2 each) shown with a 10 mm socket. They are located on the opposite side of the cross support where you just drilled the two holes.



221. Gather the following parts. These are the lower supports for the Low Temperature Radiator (LTR).



222. Install the two LTR support brackets from the previous step on the opposite side from the two bolts removed two steps ago. Push up on the plastic radiator duct above the steel cross support. Start the bracket in place and rotate as you push in. It will be easier to “hook” them over the cross support a few inches inward from the holes. You will be able to push up higher on the duct there. Slide the LTR brackets over to line up with the holes (2 each) made three steps ago.



223. Secure the brackets in place by re-installing the fasteners removed from the cross support. The brackets are slotted. Adjust their position so the grommets line up with the drilled holes.



224. Gather the following parts. These are the upper and lower Low Temperature Radiators (LTR) along with foam tape, and O-rings. Both LTRs are shown from the front side as identified by the ports at the arrow locations.

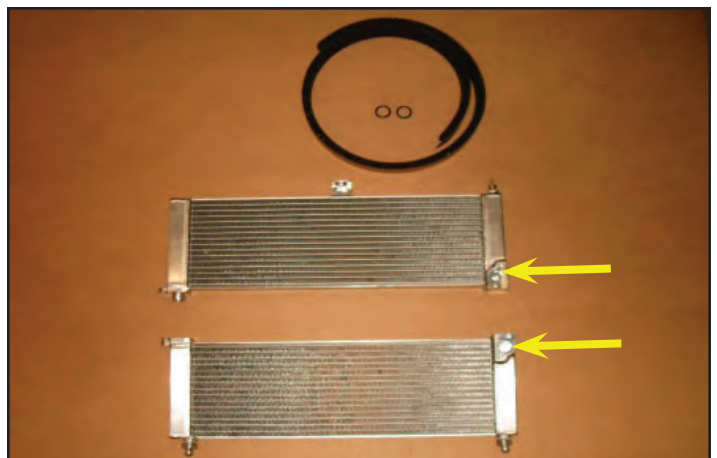

225. Apply a light coat of supplied Lubriplate grease to the two provided O-rings and install them into lower LTR. There are two grooves in the female port.



226. Wipe down the LTRs with denatured alcohol to prepare them for foam tape in the 5 areas where foam tape is shown. Install foam in locations shown of upper and lower LTRs. These are the back sides of both LTRs.



227. Apply Lubriplate grease to the mounting lugs (2 each) on lower LTR.



228. Install the lower LTR through front opening in the radiator duct. The foam faces towards the back side. Push the mounting lugs through holes in plastic, and into the LTR brackets installed previously. When pushing the LTR through the grommets it will help to support the underside of the grommet with one hand.



229. Close up of the mounting lug inserted through the rubber grommet in the mounting bracket. Make sure the lug is fully installed in the grommet, and that the grommet is secured in the bracket.



230. Front view of the lower LTR installed.

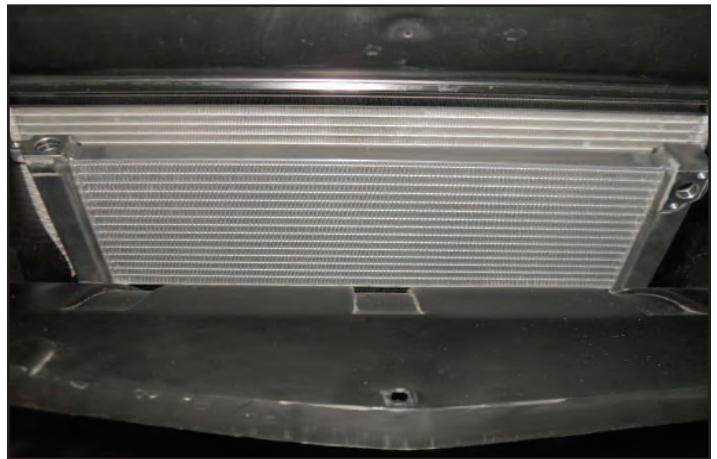

231. Apply Lubriplate grease to the male connection on the upper LTR.



232. Install the upper LTR with the male connection facing towards you and to your left. Then rotate the top of tank upwards as you move the LTR inwards as shown. Foam is facing away once installed. The center bracket will slip into the "pocket" created by the center duct mounting location (where you drilled the first hole).



233. Install the male connection from the upper LTR into the female connection of lower LTR. Line the spigot up as shown, then squeeze together at the mounting tabs as indicated by the arrows.

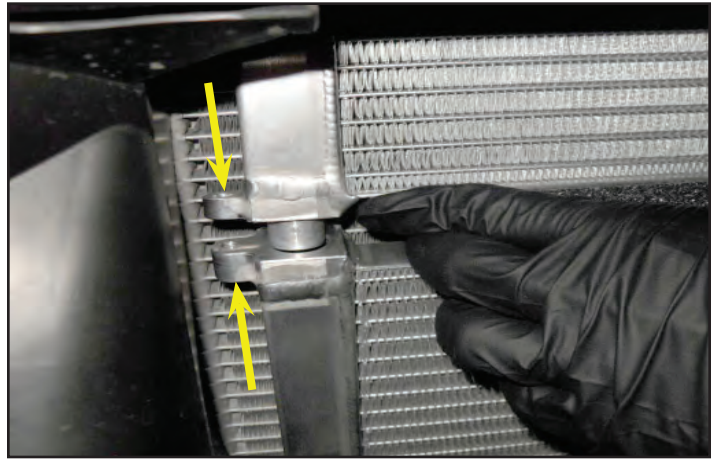

234. Gather the hardware shown. These are the socket head bolts (4 each, M6 x 20mm long), and a flange bolt (1 each, M6 x 20mm long). **Apply blue Loctite 242 to the bolts prior to installation.**



235. Apply Lubriplate grease to the O-rings on the LTR spigot. Coat the O-rings evenly and lightly with grease.



236. Install the LTR spigot at the right side of the LTRs where the holes were previously drilled. Install the socket head bolts (4 each, 20mm long) from two steps ago in the locations shown. Use a 5 mm Allen wrench.



237. Install the flange bolt (M6x20mm) from earlier step into the location between the two LTR units. Use a 1/4" drive 10 mm swivel socket to speed up the tightening.

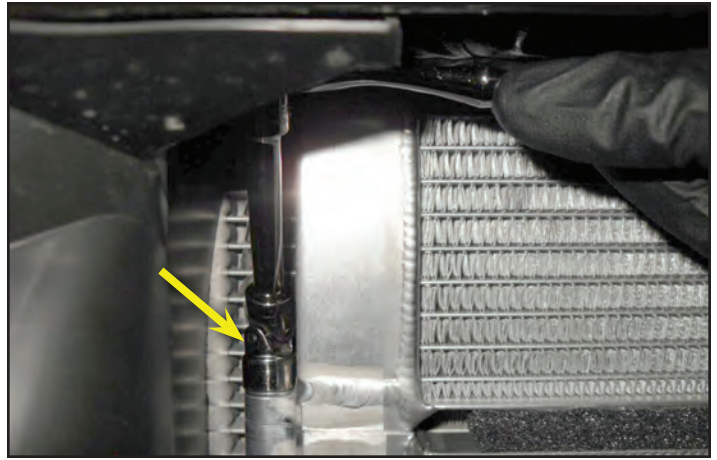

238. Gather the shoulder bolt, and the grommet shown below. **Apply blue Loctite 242 to the bolt prior to installation.** Install the grommet in the hole drilled earlier.



239. Install the shoulder bolt into the rubber grommet installed in last step. You will need to push the LTR assembly toward the A/C condenser to compress the foam backing and allow the shoulder bolt to line up with the LTR bracket.



Section 11: Cooling Pump, Reservoir and Hose Installation

240. Gather the provided coolant pump, rubber mount (Pre-installed), steel coolant pump bracket, and flange bolts (2 each, M6 x 16mm long).



241. Mount the metal bracket with the provided bolts from the last step in the location shown on left side of radiator support. **Torque bolts to 106 in-lbs.**

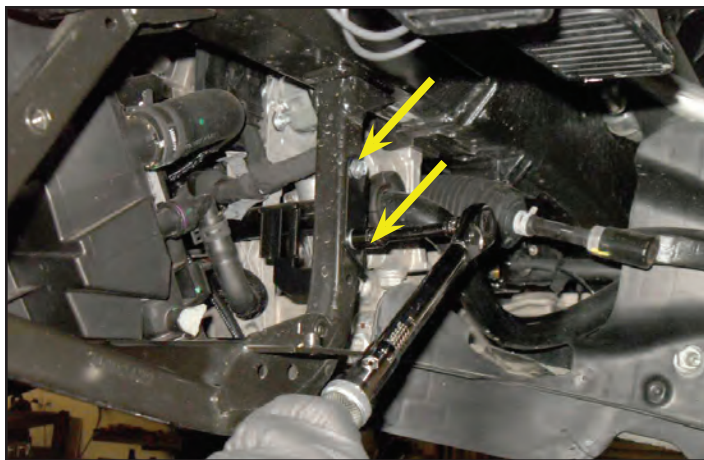

242. Grand sport models will require making sure you are on the correct side of the cooler hoses. Picture is shown with pump highlighted in green.



243. The pump should come with the rubber mount pre-installed in the orientation shown. Ensure that the stop hits at the arrow location.

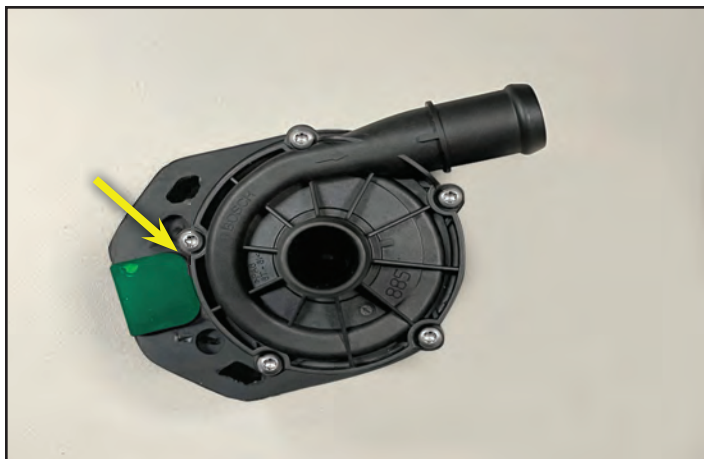

244. Insert the electrical connection to the water pump at the location shown with the green arrow. Slide the rubber mount on the steel mount where shown with the yellow arrow.

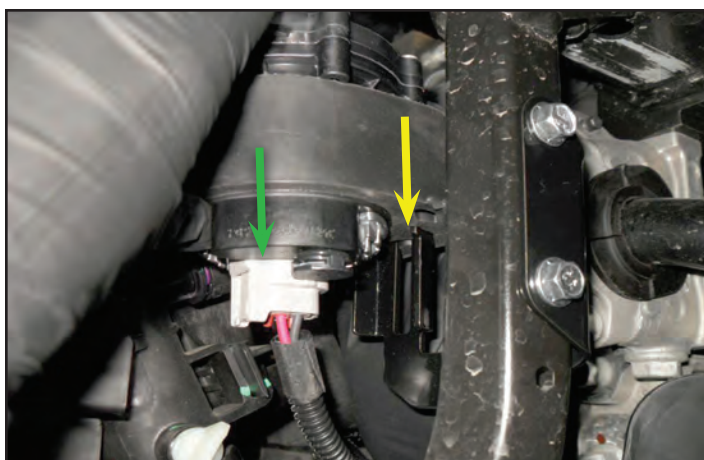

245. On left side frame rail, just in front of the vacuum pump, remove the fastener at the ground wire shown with the yellow arrow. Also remove the fastener shown with the blue arrow. Use a 13 mm socket.

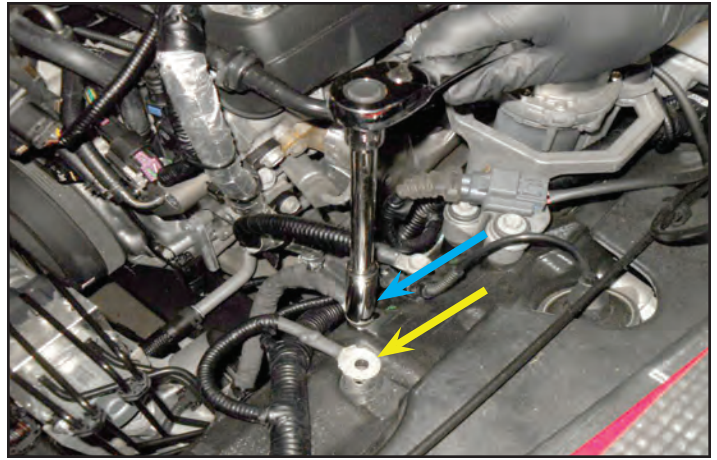

246. Move the ground wire from the yellow arrow location and combine it with the second ground wire at the blue arrow location. Reinstall the fastener and tighten.



247. Remove the cable tie fastener from the left side fender area just forward of the vacant grounding location. This location will be used for the mounting bracket.



248. Install the provided reservoir bracket in locations made from the previous steps with the two spacers provided (one shown with blue arrow) to gain clearance for the supercharger secondary belt drive. Use the provided M8x35mm hex flange bolt shown with the yellow arrow, and the provided M6x35mm flange bolt shown with the green arrow to secure the bracket. **Torque bolts to 106 in-lbs.** Take note of how the wire harness passes through the underside of the bracket.



249. Install the reservoir to the bracket. The bolts (3 each) are shipped already attached to the reservoir. Tighten the bolts by hand most of the way prior to using a wrench. Install cable tie removed in an earlier step into the location on the bracket shown with an arrow.



250. Gather the following hose. The shorter side shown at the left will attach to the pump. The reservoir side will need to be cut 4 inches from the bend at the dashed line as shown.

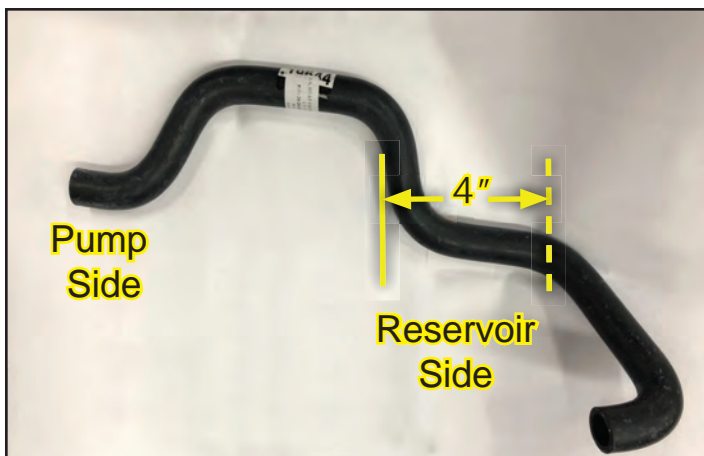

251. Install the shorter side of the hose from the last step on top of the pump where shown. Secure the connection with a supplied spring clamp.



252. Connect the other side of the hose from pump to the reservoir as shown using a worm gear clamp.



253. Gather the four provided 4"x18"x3/4" 90° hoses and cut one to 13.5" on the longer side measured from the outside edge. Cut the other three hoses to 7.5", 3" and 2.5" on the longer side as well.



254. Measure opposite sides of the hoses from the last step and cut off all four hoses to 4" as shown here.

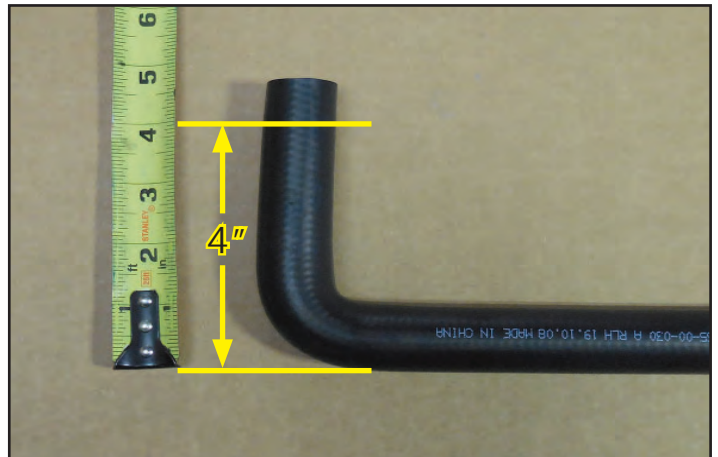

255. Gather the two provided "Y" connectors and the two provided quick connectors.



256. Cut 31" and 17" of the provided 3/4" hose and attach them to one of the "Y" connectors along with the 4"x13.5"x3/4" 90° hose that was cut earlier as shown here. Attach one of the quick connectors on the 4" section of the 90° hose. In the next two steps we will test fit the hoses to make sure they are rotated correctly.

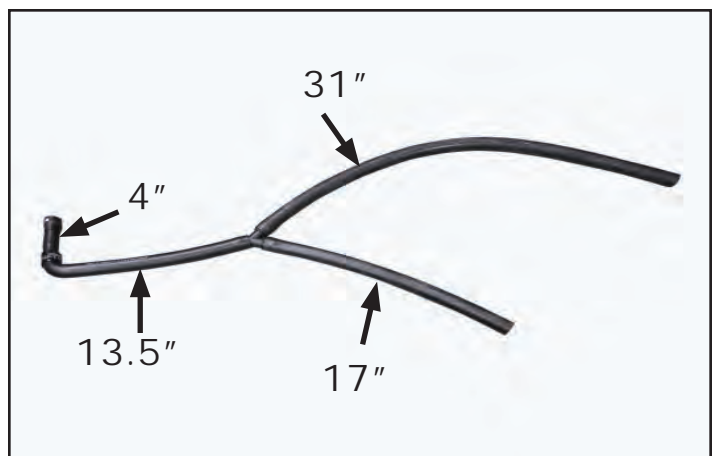

257. Attach the 31" and 17" sections of hose to the lower charge air cooler spigots on the supercharger as shown highlighted in green. Route the 4"x13.5" 90° hose to the left of the radiator.



258. Partially slide on the 4" section of the 90° hose to the upper spigot of the low temperature radiator, but do not engage the locking mechanism. Rotate the hose connection of the 4"x13.5" 90° hose at the "Y" connection if necessary to allow the hoses to route properly.



259. Cut 38" of provided 3/4" diameter hose and attach it to the other "Y" connector along with the 4"x3", and 4"x2.5" 90° hoses that were cut earlier as shown here. The 4" sections will attach to the "Y" connector. Ensure that the hoses are rotated as shown here. We will test fit this assembly in the next step.

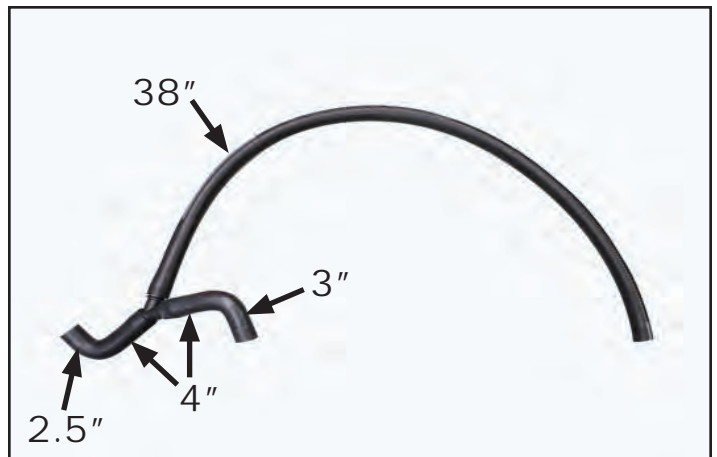

260. Attach the 3" side of the 4"x3" 90° hose and the 38" hose to the upper charge air cooler spigots on the supercharger as shown. Also attach the 2.5" side of the 4"x2.5" hose to the rear inlet on the reservoir. The hose assembly has been highlighted in green. Rotate the hoses at the "Y" connection to allow them to route properly. Now carefully remove the two hose assemblies so you can install the shrink clamps out of the engine compartment.



261. Gather the provided 8 shrink clamps. Crush the cardboard on these clamps to remove them.



262. Ensure that all hoses are bottomed out as shown. Slide the clamps over the three connections for the “Y” as shown. Ensure that you keep the clamps within less than 1/8” from the ends of the hoses as you heat them in the next step.



263. Use a heat gun to shrink the clamps that were installed in the last step. Move the heat gun continuously around the clamps to provide even heating. Ensure that they remain within less than 1/8” from the hose ends as you shrink them. You should see a slight hump in the middle of the clamp as it conforms to the shape of the hose barb under the hose. Test all connections after they have cooled by pulling them to confirm they are tight. **Repeat this procedure on the second “Y” connection and the quick connector end.**



264. Install the 17” mesh sleeve (highlighted in green) over the 4”x13.5” 90° hose. It will take a little bit of a stretch to get it over the fitting.

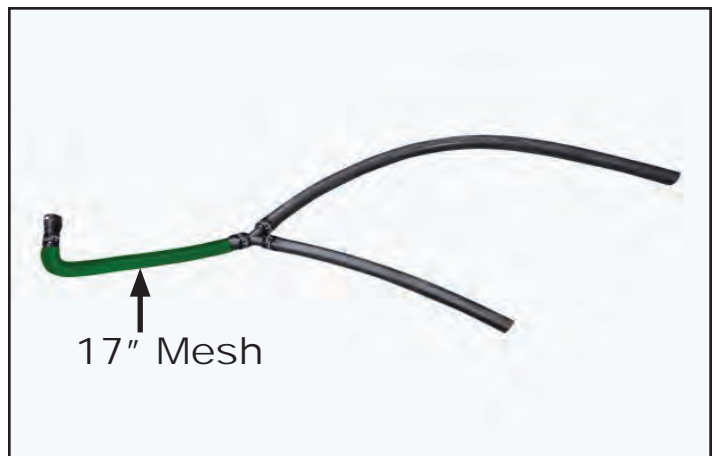

265. Once you have secured all the connections with shrink clamps you can reinstall the lower hose assembly at the two lower charge air cooler spigots again. Use two supplied spring clamps to hold the hose at the arrow locations. **Ensure that the clamp ears face towards the outside edges of the supercharger.**



266. Apply Lubriplate grease to both LTR spigots shown. Make the connection on the opposite side of the lower hose assembly from the previous step to the upper LTR spigot. Confirm that the fitting has locked in place by pulling on it.



267. Lightly secure the lower hose assembly from the last step in place using a cable tie (highlighted in green) with a tree attachment at the hole shown with the green arrow. Do not overtighten the clamp.

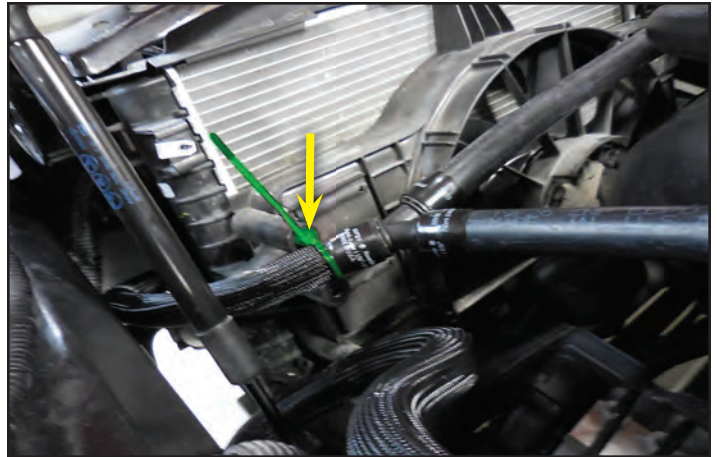

268. Gather the 4"x7.5" 90° hose that was cut earlier and install the shrink clamp and the quick connect fitting on the 4" side. Shrink the clamp in place as you did with the other 7 connections.



269. Install the 4"x7.5" 90 degree hose at the pump location highlighted in green. The LTR connection is a quick connect. Secure the pump side connection of this hose with a provided spring clamp.

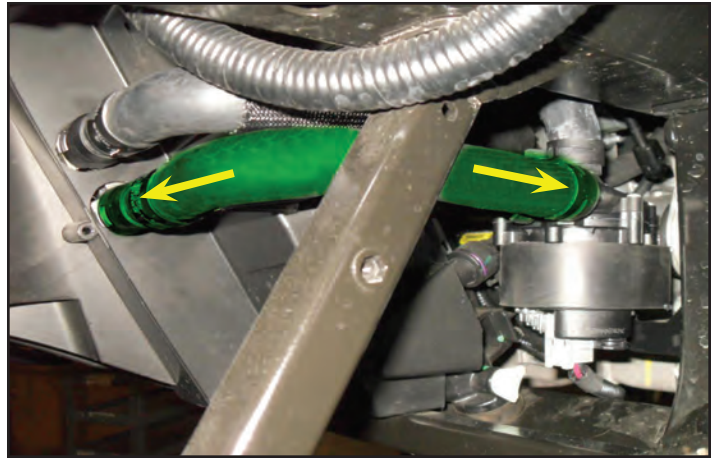

270. Now reinstall the upper hose assembly to the upper charge air cooler spigots and secure with the provided spring clamps. **Ensure that the clamp ears face inwards. This is opposite to the clamps below to give more clearance.**



271. Route the vent hose near the hood release cable. Connect the vent hose at the top of the upper LTR where shown with a green arrow and secure with a spring clamp. It will be necessary to use needle nose pliers to slip the clamp over the barb. Install cable ties (3 each) in the locations shown.

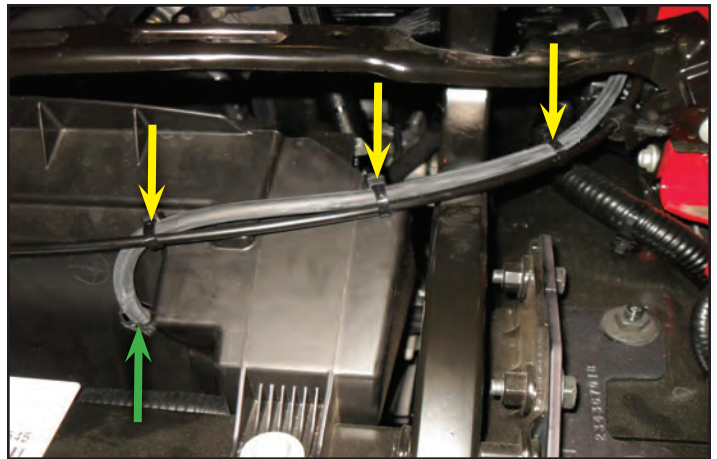

272. Install a cable tie at the red arrow location. Install the opposite end of the vent hose at the reservoir connection shown with the yellow arrow and secure with a spring clamp. If required, trim the hose so there are no kinks.

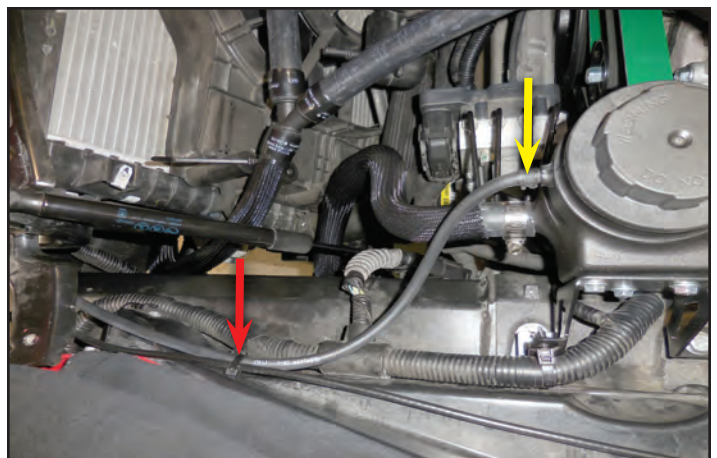

273. Gather the following provided inlet hose parts shown below. There is a silicone turbo hose, metal adaptor, and a hose clamp. Install the metal adaptor into the turbo hose with one inch exposed and tighten in place with a hose clamp as shown in the image at the right.

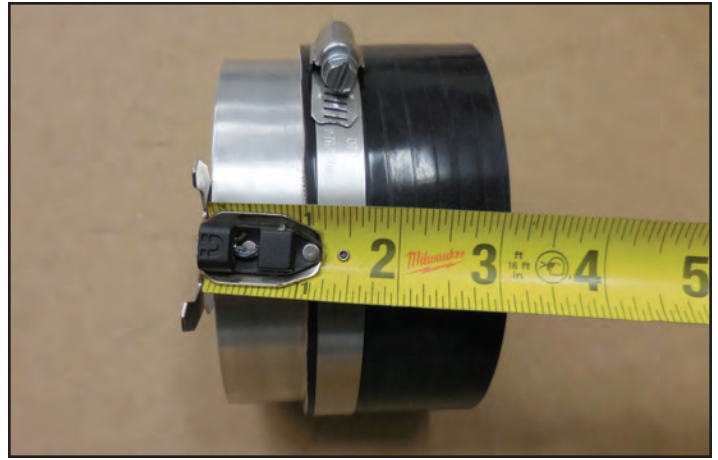

274. Insert the assembly from the last step into the inlet air tube and secure in place with a provided hose clamp. Add a provided hose clamp to both sides of the air tube for installation in the next step.



275. Install the inlet air tube between the throttle body and the air box as shown and secure in place with the two hose clamps. Ensure that the inlet air tube bottoms out at the throttle body and that the turbo hose bottoms out against the air box connection. Rotate the hose clamp bolts in the positions shown with arrows here and ensure that they are all tight. Ensure that all hoses run next to each other and do not overlap in this area to allow clearance for the air duct that will be reinstalled later.

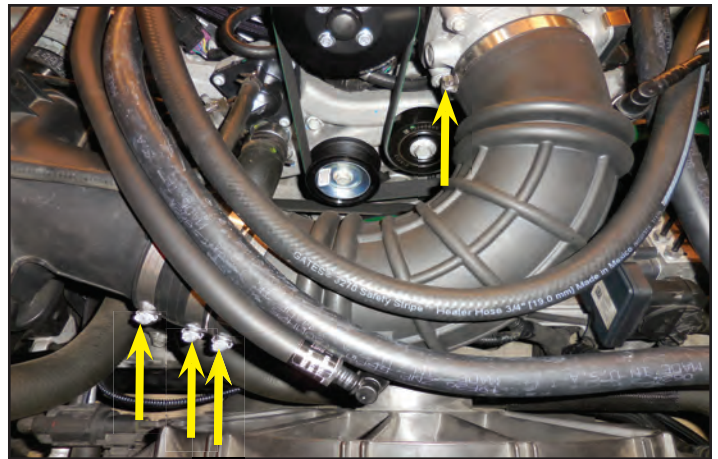

276. Install the green highlighted vent hose in the location shown.



277. Plug in the connection for the lower connection for the vent hose at the front of the air tube shown at the arrow. Ensure that the connector engages with a click and test it by pulling.

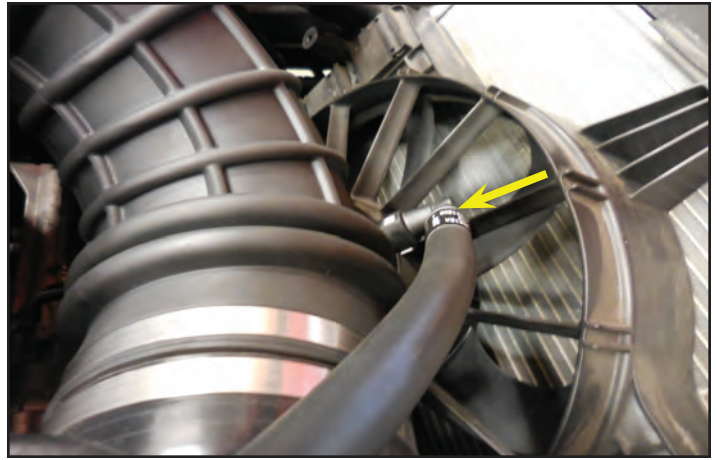

278. Gather the OEM PCV hose for the driver's side valve cover and reconnect at the green highlighted area. Ensure that both sides engage by pulling at the connections.

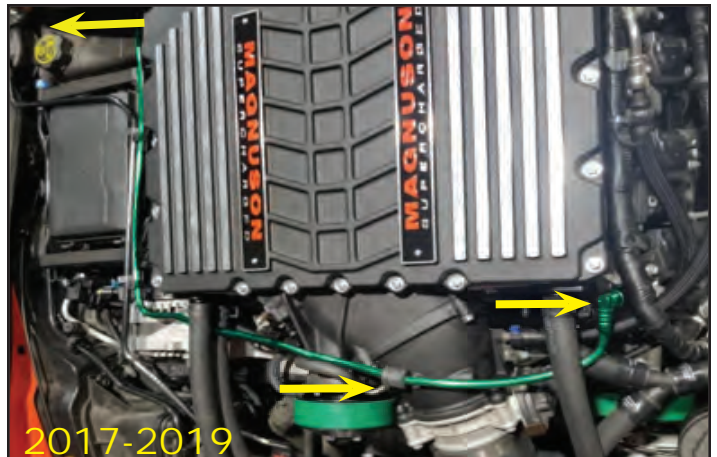

279. 2017-2019 application with the unused vacuum port need to be plugged with the supplied 3/8" vacuum cap.



Section 12: Hood Liner Removal

280. Remove the T-15 bolts (yellow arrow locations) securing the air duct shroud under the hood. On the bottom side, pull the shroud away from the hood to disengage the bottom clips. With gaps on the side pull away from the top to fully remove.

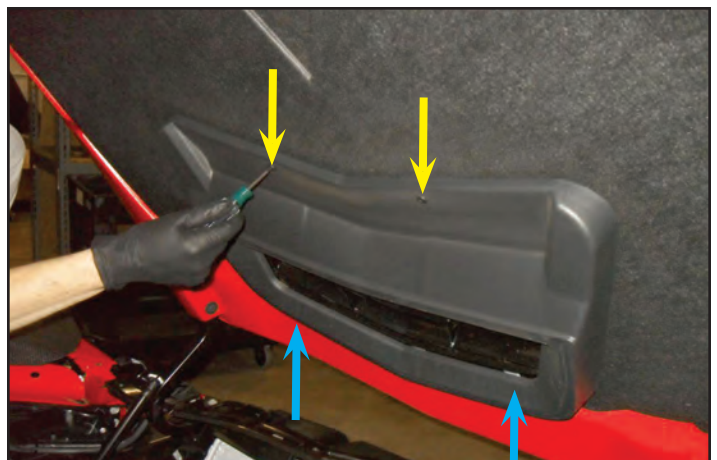

281. Remove the plastic rivets (6 each) securing the hood liner.

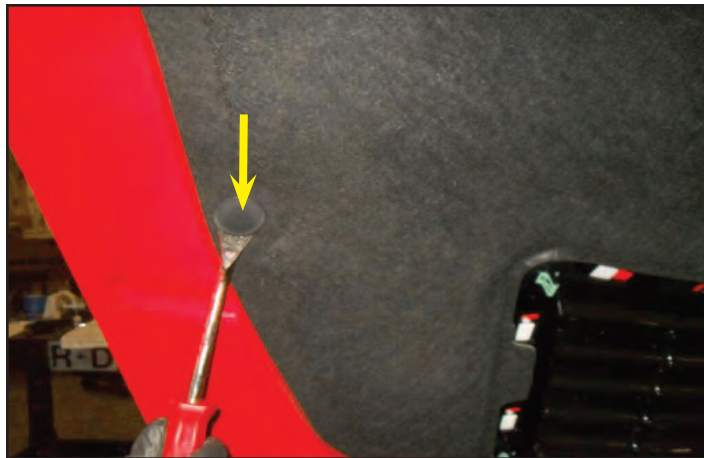

282. Remove the hood liner by pulling it up out of the slots. It is best to have a helper to pull the liner out evenly on both sides to prevent tearing. Once you have removed the hood liner you can reinstall the air duct that was removed three steps ago.



Section 13: Coolant Fill, Reinstall Body Panels, and Final Testing

283. Connect the battery and tighten with 10 mm wrench.



Make sure that you have followed step #1 in this manual to load the proper supercharger calibration to your vehicle's ECM.

*****WARNING: You must perform a vacuum leak down test on your intercooler system prior to adding any coolant. This can be accomplished with the same equipment that is used for engine cooling systems.*****

284. Place rags around the intercooler reservoir. Use the GM approved engine coolant mixture to fill your intercooler reservoir to capacity. You can temporarily leave the cap off the reservoir to monitor coolant level. Clear tools and other items from engine area.



285. Press down and hold in the Engine Start/ Stop button for 5 seconds **without** touching the brake pedal. **Do not start the engine.** All dash lights will come on, and the intercooler pump will begin to circulate coolant. While the pump is running check for circulation in the reservoir, and coolant leaks. Press the Engine Start/Stop button a second time to shut off the coolant pump. Check the coolant level of the intercooler reservoir. Fill the reservoir to the base of the neck on the housing. Do not let the pump run dry. Check the system for leaks.



286. Double check bracket shown to ensure it is aligned and tightened properly if it was loosened in a previous step. The top of the bracket lines up level and even with the bottom of the body panel as shown. **Torque the bolts to 35 in-lbs.**



287. Reinstall all fasteners and panels taken off in previous steps for front fascia in reverse order.



288. Reinstall the radiator duct using the OEM bolts (4 each) and a 7 mm nut driver.



289. Torque wheels after installation. The torque specification can be found in your owner's manual.



290. The supercharger is shown fully installed. Start the engine and check for coolant, and fuel leaks. Also check the supercharger belt alignment. Test drive vehicle for the first few miles under normal driving conditions. **Do not attempt any wide open throttle runs.** Check for any unusual sounds, vibrations, or engine misfires. The supercharger does have a slight whining noise under boost conditions, which is normal. After the initial test let the engine cool down, and recheck coolant levels.



291. After the initial test drive gradually work the vehicle to wide open throttle runs. Listen for any engine detonation (pinging). If engine detonation is detected let up on the throttle immediately. Most detonation is caused by low octane gasoline still in the tank. Premium 91 octane fuel is required. Enjoy your new supercharger!



After you finish your installation and road test your vehicle, please fill out the warranty registration. This can be found on our website.

292. Clean the surface in the location shown with the green circle and apply the provided CARB label.

If you have questions about your vehicles performance, please check with your installation facility.



Appendix

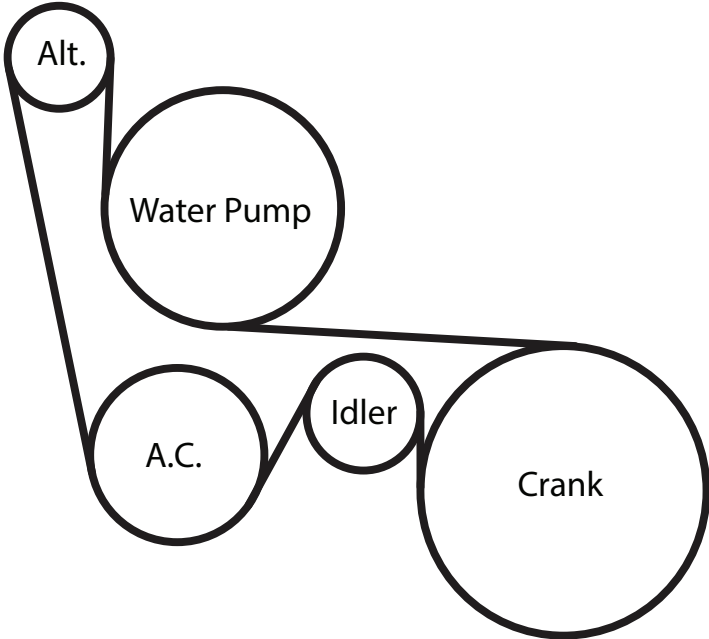

Primary Belt Diagram

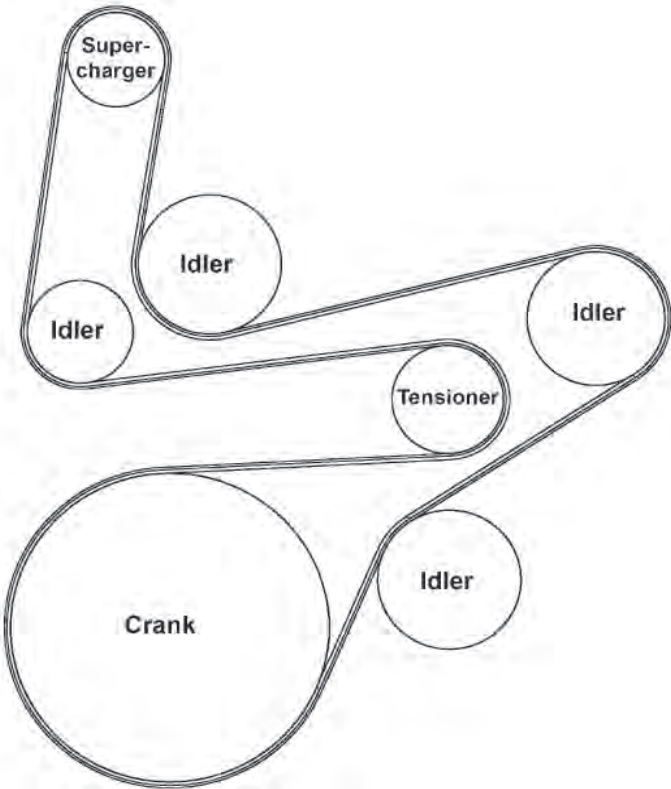

Supercharger Belt Routing Diagram

Torque Specifications

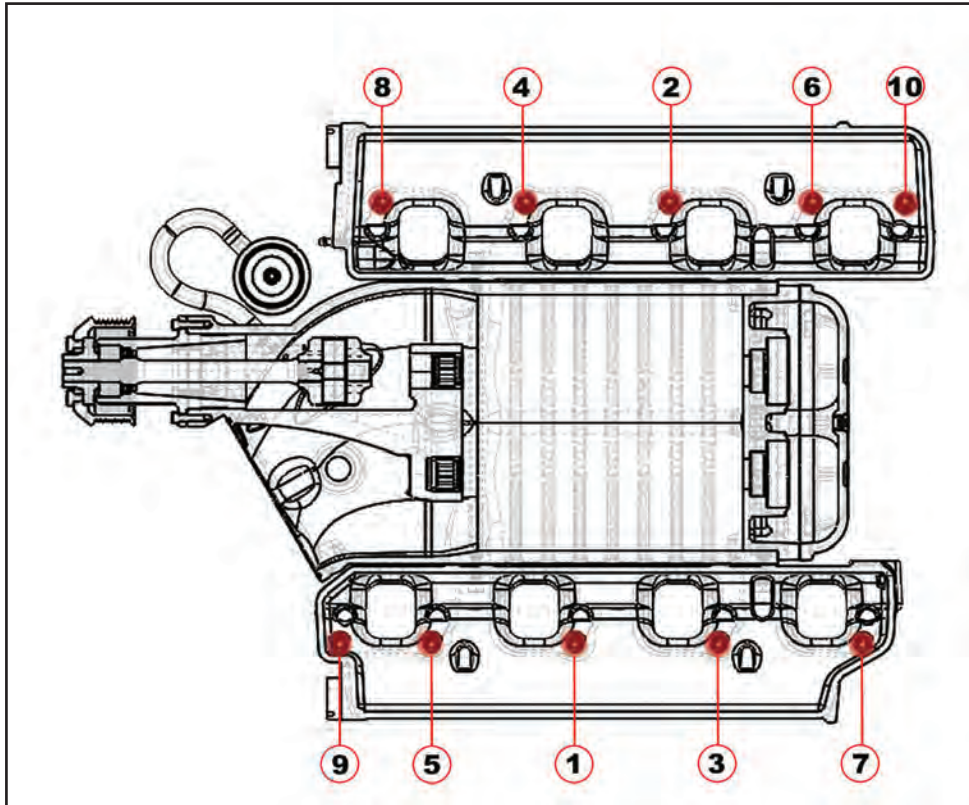

Supercharger to Cylinder Heads: 106in-lbs

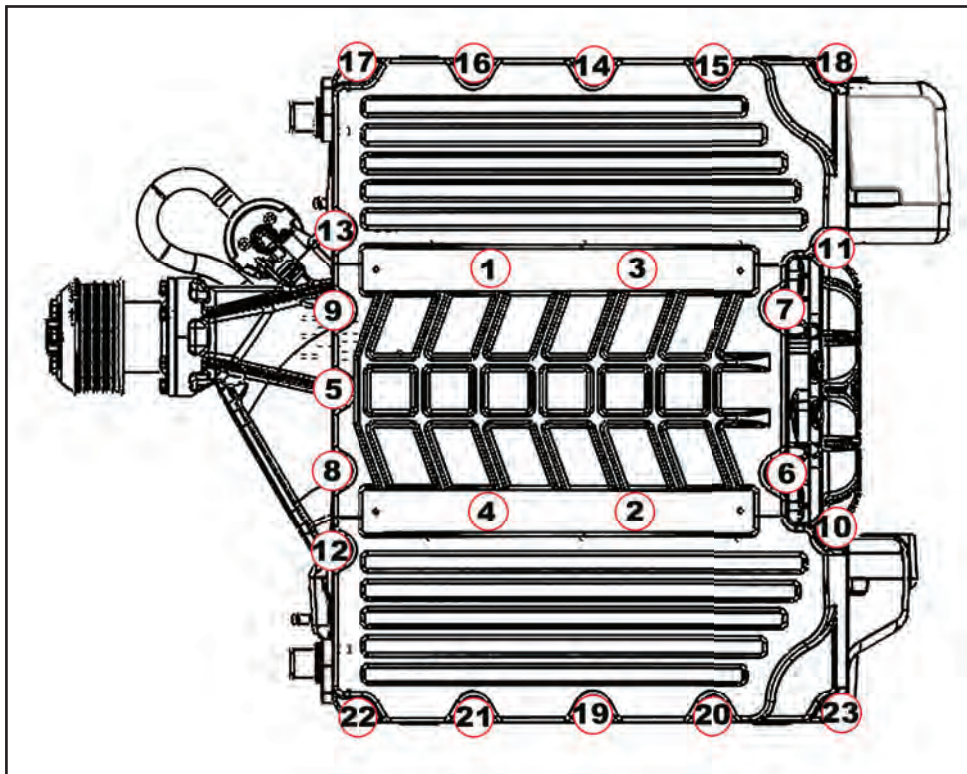

Lid to Supercharger Housing: 106in-lbs



Please enjoy your "Magnuson SuperCharged" performance responsibly.

Use only premium gasoline fuel, 91 octane or better.

MAGNUSON
SUPERCHARGERS