

MAGNUSON

SUPERCHARGERS

Installation Instructions for:
2006 - 2009 Toyota 4Runner 4.0L



Step-by-step instructions for installation of
the supercharger system.

*** PREMIUM GASOLINE FUEL REQUIRED ***



ATTENTION!
Your MAGNUSON SUPERCHARGER kit
is sensitive to corrosion!
Use only the vehicle manufacturer
recommended coolant for your engine in
the intercooler system as well.

Magnuson Products LLC
1990 Knoll Drive, Bldg A, Ventura, CA 93003
(805) 642-8833 phone
magnusonsuperchargers.com

INSTALLATION MANUAL

Magnuson Supercharger Kit: Toyota 4Runner 4.0L

Please take a few moments to review this manual thoroughly before you begin work: Make a quick parts check to be certain your kit is complete (see Bill of Material (BOM) parts list inside the accessory box). If you discover shipping damage or shortage, please call our office immediately. Take a look at exactly what you are going to need in terms of tools, time, and experience. Review our limited warranty with care.

Use only premium gasoline fuel, 91 octane or better.

Magnuson Products recommend that you run a minimum of one (1) tank of premium fuel through your vehicle prior to installation of the system to prevent any possible damage that may occur due to running the supercharged engine on lower octane fuel.

Magnuson Products Supercharger systems are designed for engines and vehicles in "GOOD" mechanical condition. Magnuson Products recommend that a basic engine system "Health Check" be performed prior to the installation of this supercharger system. Be sure to check for any pending or actual OBDII codes and fix/repair any of the stock systems/components causing these codes. If there are codes prior to the installation they will be there after the installation.

Magnuson Products also recommend the following services to be performed on your vehicle before starting and running the vehicle post supercharger system installation:

- Fuel Filter change
- Engine oil and filter change using brand name oil (organic or synthetic) and filter

Note: It is VERY IMPORTANT to use the factory specified oil viscosity. The original equipment manufacturer has selected this grade of oil to work with your other engine systems such as hydraulic chain tensioner and variable cam controls. Deviation from this specification may cause these systems to fail or not function properly. Please refer to your owner's manual for the recommended oil viscosity for your engine and application.

On older vehicles Magnuson Products recommend these additional services to be performed:

- Coolant system pressure test and flush. **NOTE: YOU MUST USE TOYOTA SPECIFIED COOLANT MIXTURE!**

Non "Magnuson Approved" calibrations or "tuning" will Void ALL warranties and CARB certification.

Our supplied calibration is designed for use with the components provided in this kit. Any adjustment to the intake, or exhaust systems or other engine components may adversely affect engine performance and may trigger your check engine light.

Drive belt = DAYCO #21-2973

Tools Required

- Metric wrench set**
- Metric 3/8" and 1/2" drive metric socket set (standard & deep)**
- 3/8" and 1/2" drive ft-lbs and in-lbs torque wrenches**
- Metric Allen socket set 3/8 drive**
- Metric Allen wrenches**
- Phillips and flat head screwdrivers**
- Serpentine belt tool**
- Funnel**
- Drain pan**
- Hose cutters**
- Hose clamp pliers**
- Safety glasses**
- Nut driver**
- Compressed air**
- Impact gun and 24mm impact socket**
- Air gun**
- Torx socket set 3/8 drive**
- Clip removal tool**
- Telescoping magnet**
- Anti-seize assembly lube (for spark plugs)**

Contact Information:

**Magnuson Products LLC
Magna Charger Division
1990 Knoll Drive, Bldg A
Ventura, CA 93003**

Sales/Technical Support Line (805) 642-8833
Websites www.magnusonsuperchargers.com
Email sales@magnusonproducts.com

Table of Contents

Section 1: Initial Preparation	5
Section 2: Intake Manifold Removal	6
Section 3: Fuel Injector Replacement	15
Section 4: Spark Plug Replacement	19
Section 5: Fan Shroud and Radiator Hose Removal	22
Section 6: Auxiliary Drive Installation	26
Section 7: Heater Hose Modifications	34
Section 8: Supercharger Preparation and Installation	37
Section 9: Intercooler Pump Installation	44
Section 10: Intercooler Reservoir and Hose Installation	48
Section 11: Intercooler Pump Wiring Connections	53
Section 12: Vacuum Hose and Air Cleaner Installation	56
Section 13: Coolant Fill and Vehicle Testing	59

NOTE: This instruction manual follows the process we used to complete this installation on our test vehicle. This does not imply there aren't alternate approaches.

Section 1: Initial Preparation

1. If your kit has a provided handheld tuner follow the instructions in the provided pamphlet to install your tune. **WARNING: DO NOT BEGIN THE INSTALLATION BEFORE OBTAINING YOUR NEW CALIBRATION FILE. IN SOME CASES, ESPECIALLY WITH NEWER VEHICLES, THIS STEP CAN TAKE SEVERAL DAYS AND YOUR VEHICLE WILL BE IMMOBILIZED WHILE YOU WAIT FOR THE NEW CALIBRATION FILE.** Your handheld tuner may not match the one shown.



2. Your Intercooler system is sensitive to corrosion. It's very important to use the OEM recommended coolant mixture in your supercharger system as well.



3. Your system requires the use of a minimum 91 Octane gasoline fuel. This system is **not** compatible with E85 fuel.



Any reference to the left or right side of the vehicle is given from the driver's seat perspective.

4. Remove the negative battery cable from the battery with a 10mm wrench. The battery is located in the left front area of the engine compartment. Ensure that the cable, and lead are covered with a rag or other suitable insulator to avoid accidental connection.

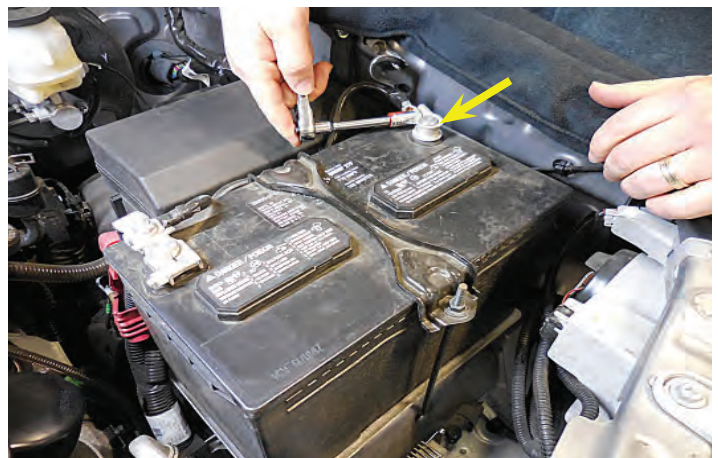

Section 2: Intake Manifold Removal

5. Remove the engine cover by removing the two acorn nuts shown with arrows.



6. Disconnect the ventilation hose shown with an arrow. View of skid plate being removed.



7. Disconnect the vacuum hose.



8. Unplug the mass air flow meter connector.



9. Remove the wire harness clamp shown with the arrow.



10. Remove the second wire harness clamp shown with the arrow.



11. Loosen the hose clamp at the air box.



12. Remove the hose clamp at the throttle body shown with an arrow.



13. Remove the two bolts shown with arrows.

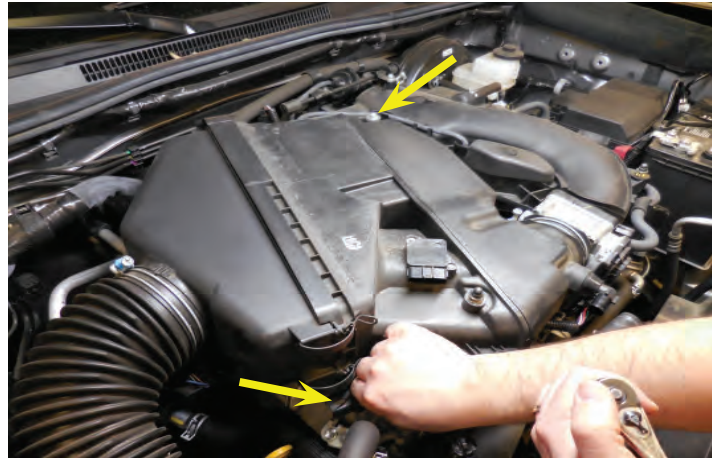

14. Remove the air box.



15. Disconnect the throttle body connector.



16. Remove the 4 bolts, and then remove the throttle w/ motor body and gasket.



17. Leave the throttle body connected to the coolant hoses for now.



18. Disconnect the fuel vapor feed hose.

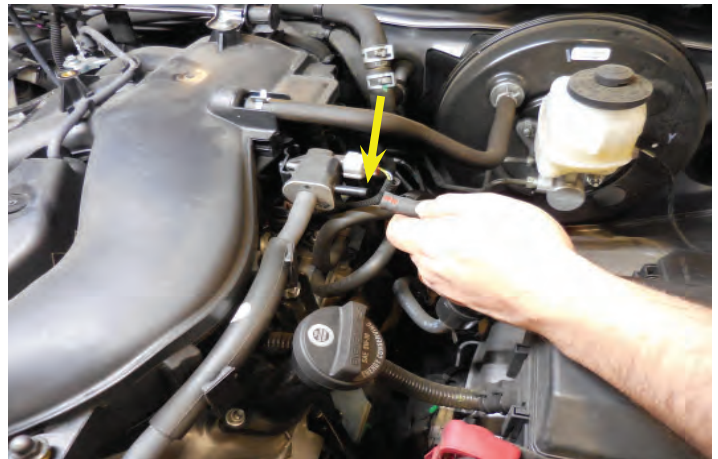

19. Disconnect the brake booster hose shown with an arrow if applicable.



20. Disconnect the ventilation hose shown with an arrow.



21. Disconnect the VSV connectors.



22. Disconnect the cable connector shown with the arrow.



23. Disconnect the ACIS connector shown. Use electrical tape to cover this connection and secure it to the wiring bundle as it will not be re-used.



24. Disconnect the harness connector shown.



25. Disconnect the cable tie for the harness shown with an arrow.

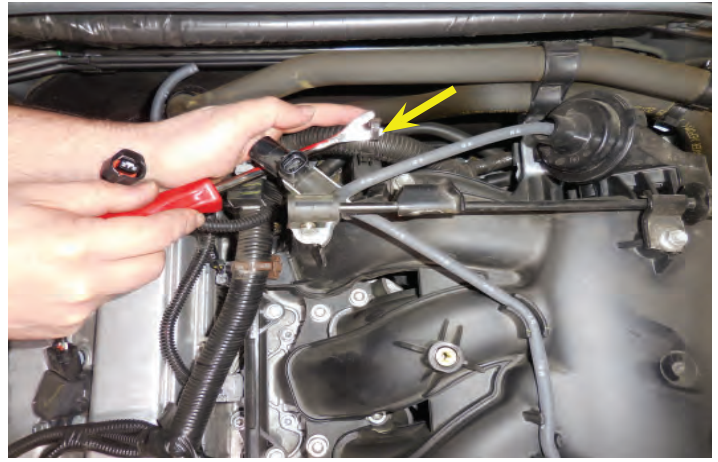

26. Remove the 4 coolant hose clamps and hose clamps shown with the two yellow arrows.



27. Remove the bolt that secures the bracket shown with the arrow.



28. This bracket must be removed to gain clearance for the supercharger.



29. Remove the front upper bolt shown with an arrow.

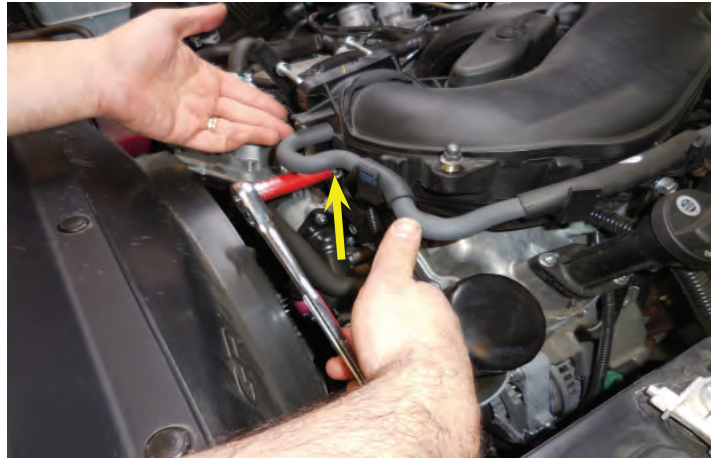

30. Remove the 2 bolts shown with arrows which are used to secure the 2 surge tank stays.



31. Remove the bolt that holds the front side bracket to the side of the cylinder head shown with an arrow.



32. Remove the bolt that holds the rear bracket to the side of the cylinder head shown with an arrow.



33. Remove and discard the bracket attached to the front of the cylinder head (Bracket stamped "A").



Wear Safety Glasses when using Compressed air

34. **CAUTION:** Before proceeding, make sure there is no dirt or debris on or around the base of the surge tank. If there is, you must remove it so that it will not enter the engine when the surge tank is removed.



35. Using an 8mm Allen socket, remove the 4 bolts (shown with yellow arrows) and the 2 nuts (shown with green arrows) with a 12mm socket. Remove the surge tank and gasket.



36. A magnet will help to remove the nuts from their locations.



37. Remove the surge tank and gasket.



38. The engine is shown with the manifold removed. Clean intake port areas with a clean dry rag. Then use Simple Green or other appropriate degreaser to clean port surfaces. Vacuum out any debris from the intake ports. Ensure that nothing gets inside the combustion chamber.

It is VERY important to not contaminate your work environment or allow any debris to fall into the exposed ports, or engine damage can occur.



39. Cover the ports with tape. Do not cover the studs with tape because they will be removed in the next step.



40. Remove the studs using an E-5 internal Torx socket. A 5 mm socket may also work if you do not have an E-5 Torx.



Section 3: Fuel Injector Replacement

41. Remove the gas cap, and leave it off to allow fuel pressure relief.

Warning: The Fuel System is under High Pressure. Use Safety Glasses and Fuel Compatible Gloves to prevent Personal Injury

Remove any dirt and foreign objects from the connectors before performing this work. Do not allow any scratches or foreign objects on the parts when disconnecting, as the fuel tube connector has the O-ring that seals the pipe. Perform this work by hand. Do not use any tools. Do not forcibly bend, twist or turn the nylon tube. Protect the disconnected parts by covering them with a plastic bag after disconnecting them. If the fuel tube connector and pipe are stuck, push and pull to release them.

42. Place a rag down to catch any fuel runoff. Remove the fuel pipe clamp shown with the arrow.

43. Pinch the tube connector, and pull the fuel pipe out of the connector as shown.

44. Repeat the process from the two previous steps for the No. 2 fuel pipe shown with an arrow.



45. Disconnect the 6 fuel injector electrical connectors.



46. Remove the 6 bolts holding the fuel delivery pipes in place.



47. Remove the fuel delivery pipes together with the 6 fuel injectors.



48. This photo shows the fuel delivery pipes, and the OEM fuel injectors along with the provided fuel injectors shown with an arrow.



49. Pull the 6 injectors out of the delivery pipe. Discard the injectors as they will be replaced with new higher flow injectors. The old injectors should be saved for the customer.

NOTE: The new injectors have Mustard colored bodies, while the OEM injectors have Blue colored bodies.



50. Install a light coat of spindle oil or gasoline to the O-ring on the top of each new injector. While turning the fuel injector left or right, install it onto the fuel delivery pipe positioning the connector facing outward. Repeat for all six new injectors. Apply a light coat of spindle oil on the injector insulators. Install insulators in the lower intake manifold



51. Inspect the injector insulators for damage and wear. If wear or damage exists, replace the insulator with Toyota part number 23291-23010 or equivalent superseded part.



52. If the injector insulators are not located on the OEM injectors you will have to extract them from the intake manifold.



53. Clean the injector insulators and install them onto the new injectors. Ensure that the thicker edge of the insulator gets installed on the injector first. This will allow the injectors to get located easier onto the intake manifold.

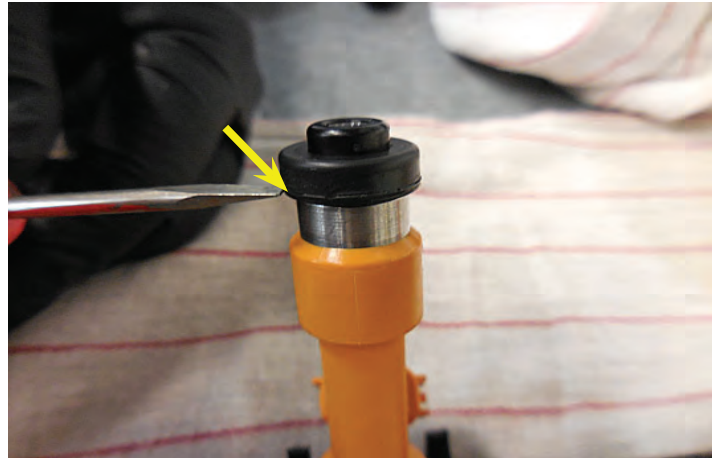

54. Place the fuel delivery pipe together with the new injectors on the intake manifold. Provisionally install the 6 bolts, which are used to hold the delivery pipe, onto the intake manifold. Check to see that the injectors rotate smoothly. Position the injector connectors facing outward.



55. Torque the 6 bolts to **15 Nm (11 ft lbf)**.



56. Reconnect the 6 fuel injector electrical connectors. Reconnect the No. 1 and No. 2 fuel pipe sub-assemblies to the fuel delivery pipe connectors by pushing together until the connector makes a “click” sound. After connecting, check that the pipe and connector are securely connected by pulling on them. Reinstall the clamps on each connector. Reinstall gas cap.

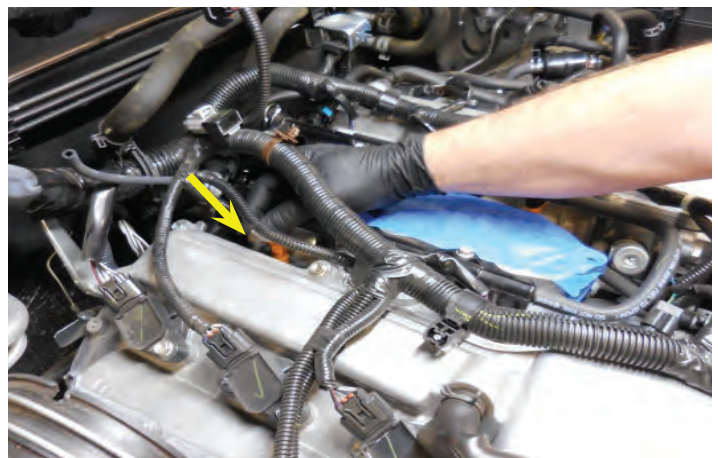

Section 4: Spark Plug Replacement

57. To ensure clearance to the supercharger manifold, pry the wire loom retainer up off the stud on the left cylinder head cover. **NOTE: Do not omit this step.**

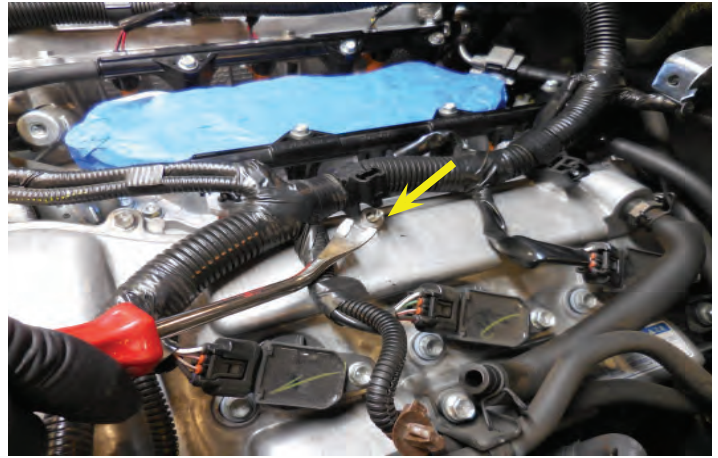

58. Unplug the electrical connector from each of the 6 ignition coils.



59. Remove the 6 bolts holding the ignition coils in place.

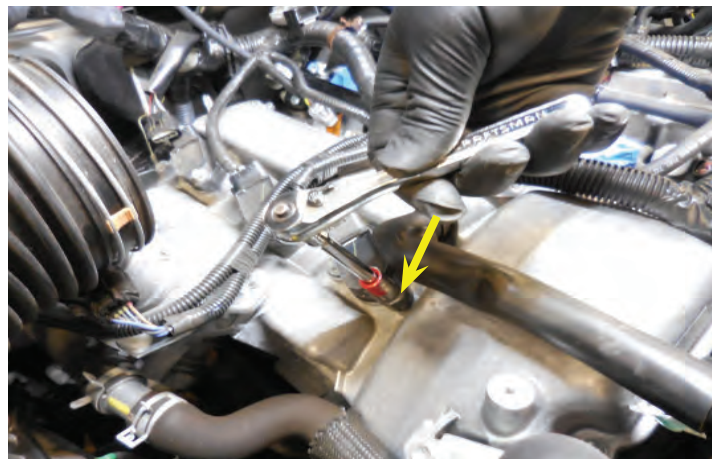

60. Remove the 6 ignition coils.

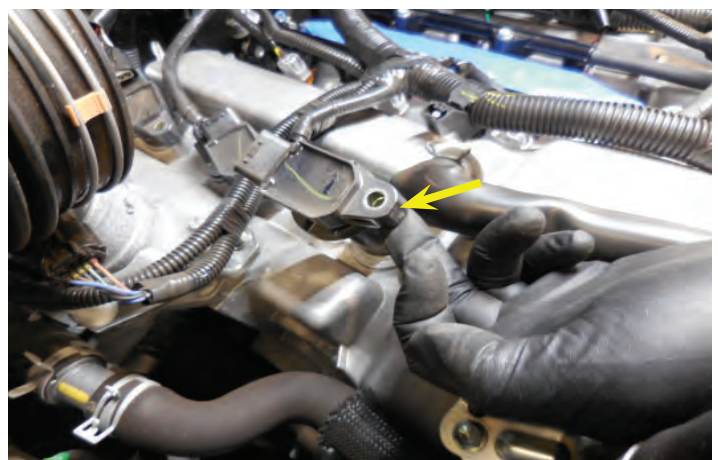

61. Push the hose shown with the red arrow out of the way to allow the left rear ignition coil to be removed.



Wear Safety Glasses when using Compressed air

62. **CAUTION: Blow any dirt or debris from around the spark plugs before removing them.**



63. Remove the 6 spark plugs and discard them in a box for the customer. New colder plug will be installed.



64. You can use a magnet to extract the spark plug from their bores.



65. Set Spark Plug Gap at **0.8 mm (0.032")**. A little anti-seize on the plug threads will prevent seizing in the future.



66. Use a piece of hose that will fit tightly around the plug (or a spark plug socket) to hand thread the 6 new spark plugs into place.



67. Thread the plugs in place using a socket and extension. Torque the spark plugs to **20 Nm (15 ft lbf)**.



68. Reinstall the ignition coils and the bolts and torque them to **10 Nm (7.4 ft lbf)**.



69. Reinstall the electrical connection for the ignition coil.



Section 5: Fan Shroud and Radiator Hose Removal

70. Remove the 7 plastic clips from the black plastic seal cover at the top of the radiator and set it aside for re-installation later. Set aside the seal cover for re-installation later.

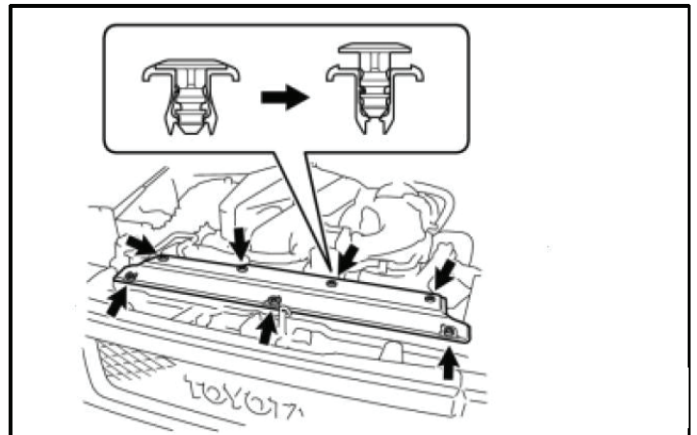

71. Remove 4 bolts, then remove the No.1 engine under cover

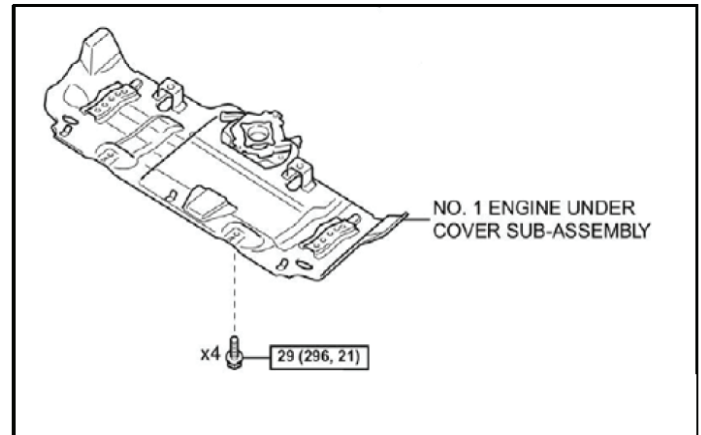

CAUTION: To avoid the danger of being burned, do not remove the radiator cap while the engine and radiator are still hot. Thermal expansion will cause hot engine coolant and steam to blow out from the radiator.

72. Remove the radiator cap and set it aside.



73. Remove the service hole cover from the engine under cover. NOTE: On some vehicles it may be necessary to remove the skid plate. Have a clean pan ready for coolant. Loosen the drain plug on the radiator (shown with the arrow and located on the right front of the engine).

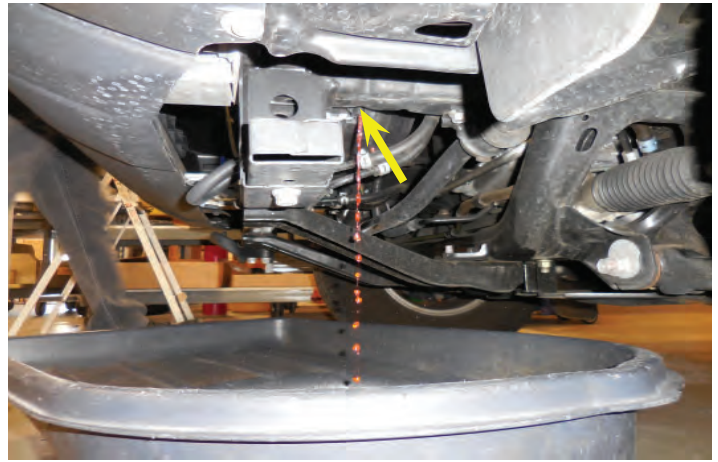

74. After you have drained the radiator you will have to drain the engine. The engine drain plugs are located on both sides of the engine, and have a spigot at the bottom. Once you have drained the engine torque the plugs to **13 Nm (9.0 ft lbf)**.

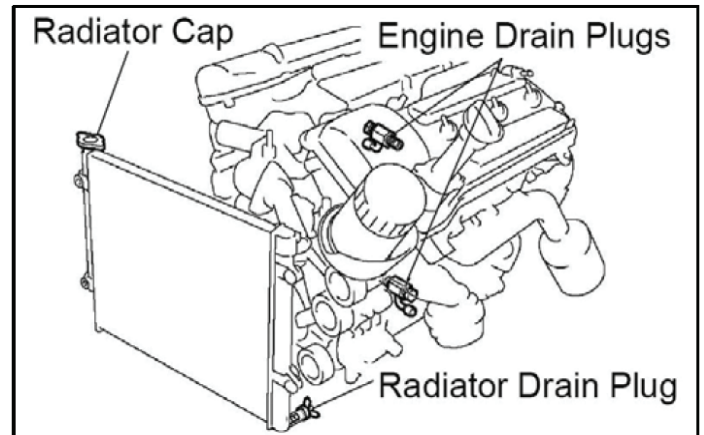

75. Remove the cap for the coolant reservoir tank.



76. Use a large cup to catch the coolant as you drain the coolant reservoir tank.



77. Remove the top radiator hose. Save for reuse.



78. Remove the four nuts that attach the fan/clutch to the fan pulley. Leave the fan in place for now.

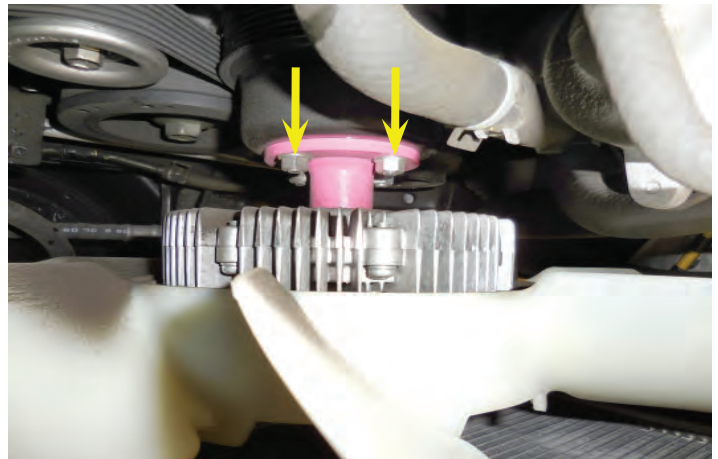

79. Remove the two bolts from the top corners of the fan shroud and the bottom corner of the coolant overflow tank.

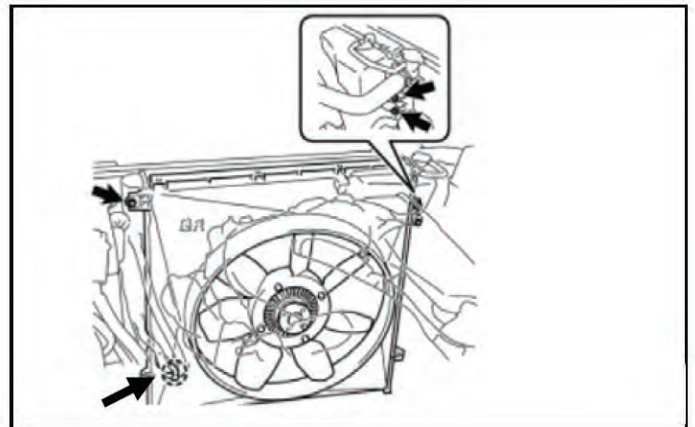

80. Disconnect the coolant overflow tube from the radiator. If the vehicle has a transmission oil cooler, it will be necessary to remove a clip holding a fluid line to the shroud.



81. Disconnect the plastic hose clamps shown with the arrow if you have a transmission oil cooler.

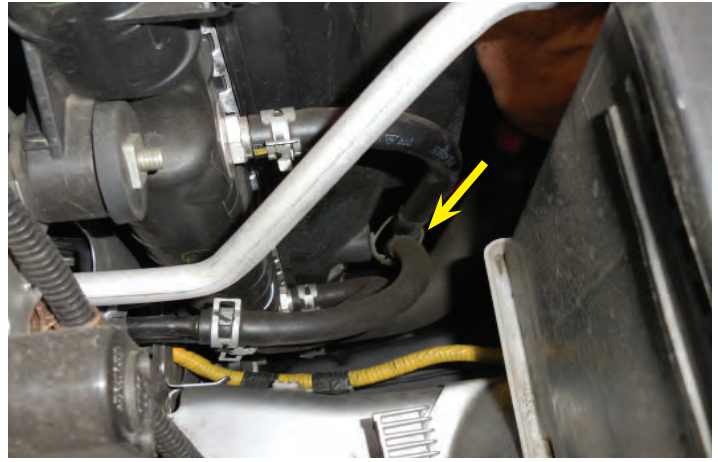

82. Carefully remove the fan and shroud together so you do not damage the radiator. You may need a second person to help you with this step.

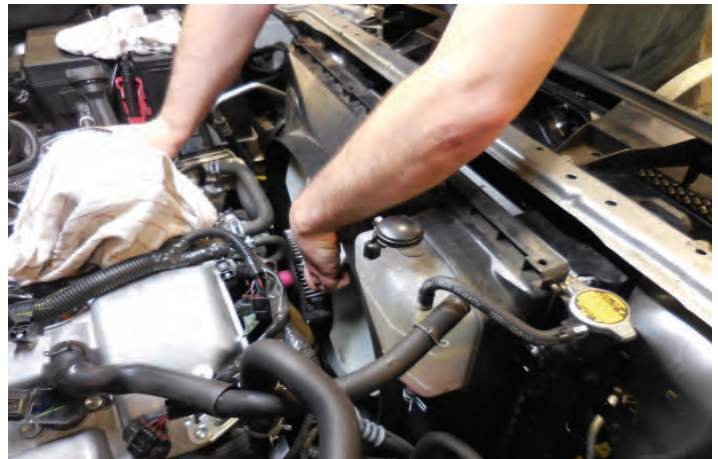

83. Note: Tape a piece of cardboard (about the size of the radiator) to the back side of the radiator to prevent damage during subsequent steps.



84. Reinstall two of the fan nuts (finger tight) so the fan pulley will not fall off.



85. Remove the lower radiator hose. The hose will not be reused. The ends of this hose are shown with arrows.

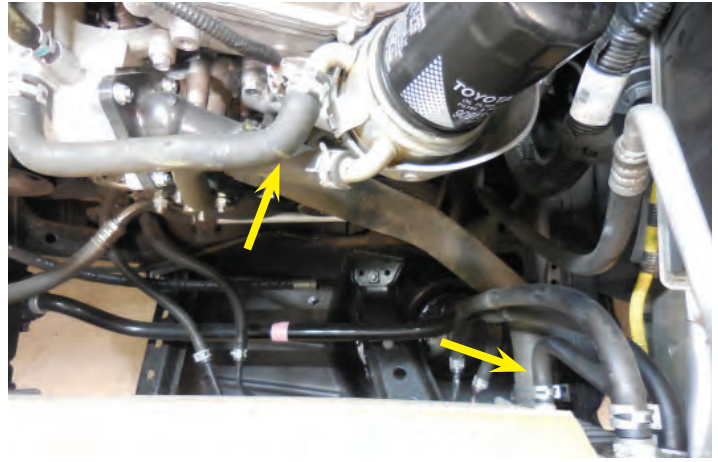

Section 6: Auxiliary Drive Installation

86. While releasing the belt tension by turning the belt tensioner (shown with the arrow) counterclockwise, remove the belt from the power steering pump pulley. **NOTE: It is not necessary to completely remove the belt.**

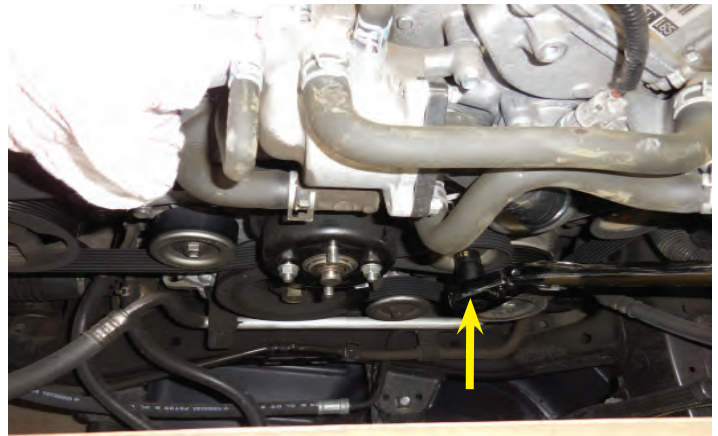

87. Remove Idler No. 1 and discard the bolt. Keep the thin step washer (if present) and pulley for the next step. **NOTE: Some vehicles may not have the thin step washer.**

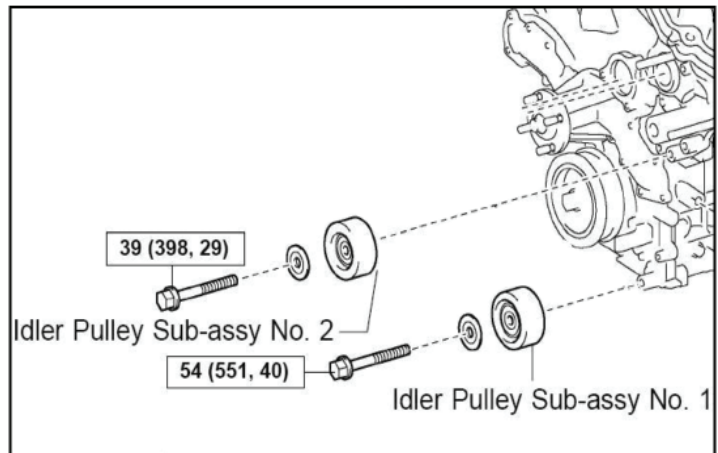

88. Here is a photo of the parts that will be installed in the location where the Idler Pulley Sub-assembly No.1 was just removed. After the M10 stud (shown at the bottom) is installed you will reinstall the original smooth pulley (with the large radius facing away from the engine) and thin step washer (if present), the idler spacer without a groove (smaller diameter facing away from the engine), the 6 rib idler pulley (snap ring facing the engine), and one of the short spacers. Temporarily install the M10 nut finger tight to hold this assembly in place. **The M10 nut will be removed later to install the belt tensioner assembly.**

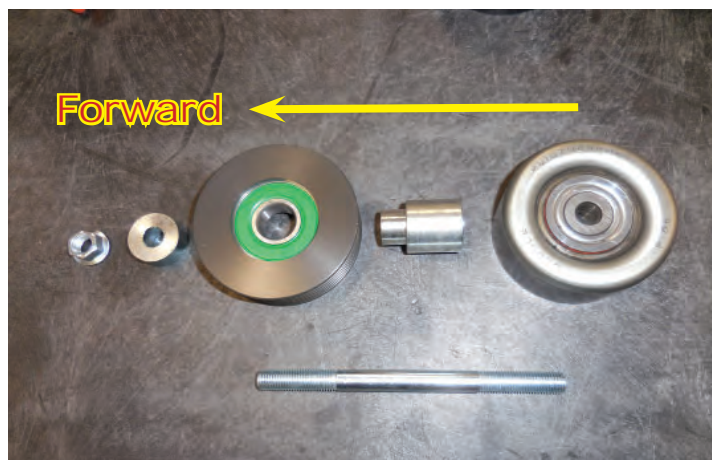

89. Install one of the double ended M10 studs and snug it in place with a flat blade screwdriver in the location where Idler Sub-assembly No.1 was removed.

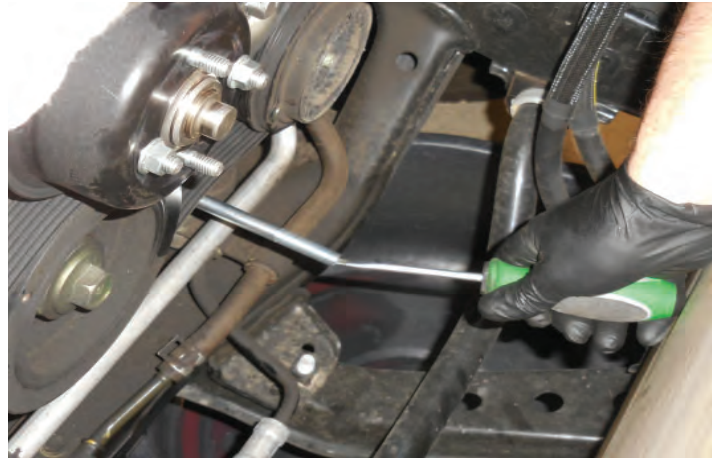

90. This photo shows the Idler Pulley Sub-assembly from two steps ago located (shown with a red arrow). Make sure to add the M10 nut finger tight to retain this assembly. Remove Idler No. 2 (shown with a yellow arrow) and discard the bolt. Keep the thin step washer (if present) and pulley for a later step. **NOTE: do not mistake Idler No. 2 for the tensioner pulley.**



91. Here is a photo of the parts that will be installed in the location where the Idler Pulley Sub-assembly No. 2 was just removed. Reinstall the original smooth pulley (with the large radius facing away from the engine) and thin step washer (if present), the idler spacer with a groove (smaller diameter facing away from the engine), the smooth idler pulley, and the other short spacer. Temporarily install the M10 nut finger tight. **The M10 nut will be removed later to install the belt tensioner assembly.**



92. Install the other double ended M10 stud in the location where idler No. 2 was removed two steps ago and snug it in place with a flat blade screwdriver.



93. This photo shows the Idler Pulley Sub-assembly from two steps ago located. Make sure to add the M10 nut finger tight to retain this assembly. **This M10 nut will be removed later to install the belt tensioner assembly.**

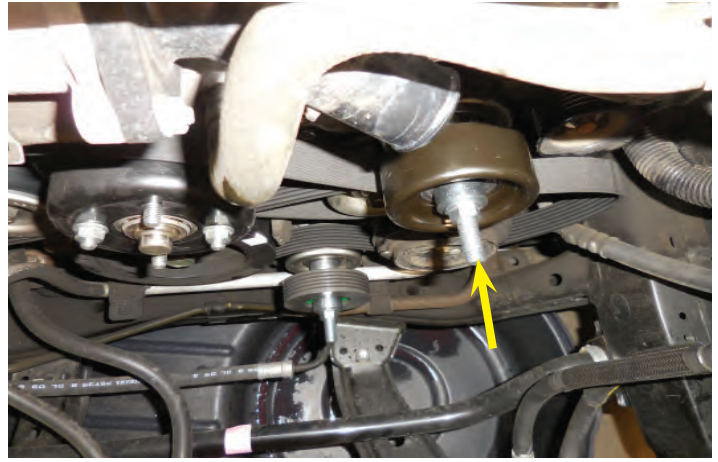

94. Reinstall the fan and generator belt.



95. Using an impact gun, remove the bolt and washer that secures the crankshaft pulley.



96. Discard the bolt and washer. **Do not remove the pulley.**



97. This photo shows the supplied washer bolt, and pulley that will be installed at the crankshaft pulley location.



98. Observe the location of the keyway in the OEM pulley (shown with an arrow). The supplied pulley has a pin that will locate with this keyway.



99. Clean the end of the crankshaft prior to installing the provided pulley.



100. Install the supplied crankshaft pulley in front of the existing crankshaft pulley making certain that the dowel pin in the new pulley is aligned with the key way in the existing pulley using the new supplied bolt and washer. **Torque the bolt to 277 Nm (204 ft lbf).**



101. Install the blower drive belt as shown. Refer to the diagram at the back of this manual for proper belt routing.

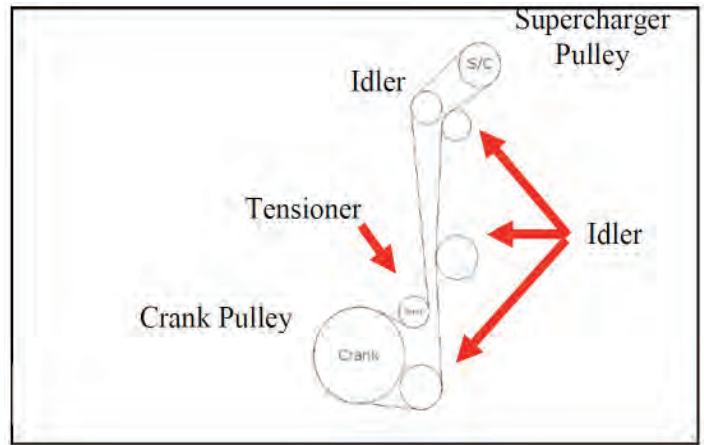

102. Remove the 2 M10 nuts that were installed previously on the two studs (shown with arrows) and replace them with 1/16" washers at both locations that are needed for A/C pulley clearance.

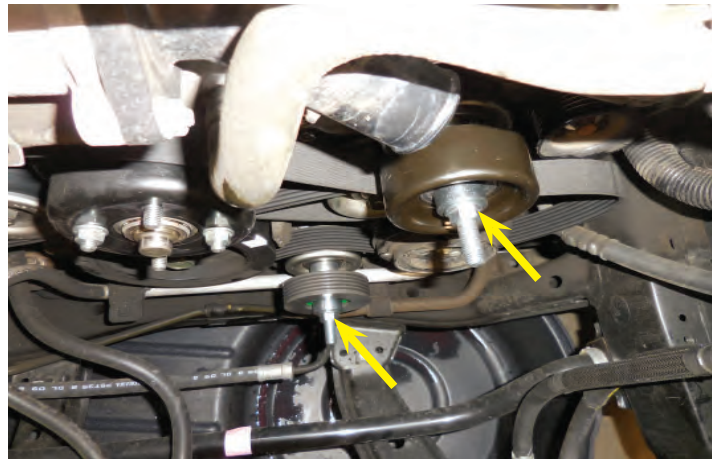

103. Install the belt tensioner assembly onto the two double ended studs previously installed. Again make sure that you have installed the 1/16" washers on each stud. Make sure both sides of the blower drive belt are free between the tensioner pulley and the upper idler pulley. Reinstall the two M10 nuts finger tight (shown with arrows).



104. Remove the top/forward AC compressor mounting bolt. **CAUTION: Do not remove the bolts that attach the AC lines to the compressor.**

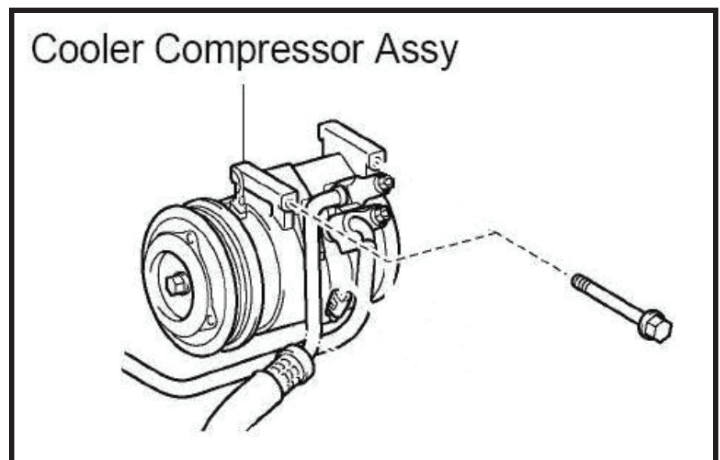

105. Using the bolt removed in the previous step, attach one end of the supplied tensioner support bracket (highlighted in green behind the belt) to the AC compressor finger tight. Attach the other end of the support bracket to the belt tensioner bracket using an M8x16 bolt. Tighten the two M10 nuts, then M8x16 bolt, and finally the AC Compressor bolt. **NOTE: Notice that the bracket goes behind the belt. Also be sure the blower drive belt is on the bottom of the tensioner pulley.**



106. Torque the **M10 nuts to 39 Nm (29 ft lbf)**. Torque the **M8 nuts to 25 Nm (18 ft lbf)**. Be sure the blower drive belt is on the bottom of the tensioner pulley.



107. Remove 2 throttle body bypass hoses and set the throttle body aside.



108. Remove the 2 small bypass hoses, and the larger bypass hose that are attached to the thermostat water manifold. It is suggested that a diagram be made showing where all the hoses go. Some vehicles may also have 2 oil cooler hoses to remove (shown with red arrows).

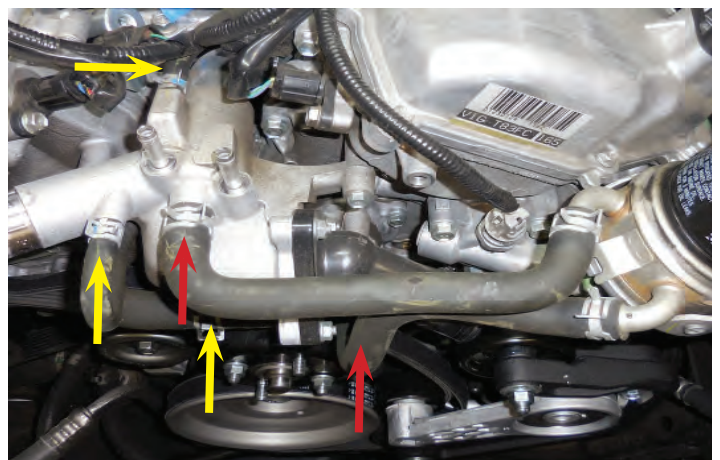

109. Remove and discard the 5 bolts attaching the thermostat water manifold to the engine. Make sure the 2 O-rings remain on the engine.



110. Apply Lubriplate grease to the inside bore of the provided water spacer pipe (shown with a red arrow) and slide it over the OEM O-ring location (shown with a green arrow). Ensure that the O-ring does not get pinched while sliding the water pipe spacer in place. Install the small provided O-ring (shown with the blue arrow) onto the supplied water pipe spacer. Apply a small amount of Lubriplate grease to the O-ring and inside the bore of the thermostat water manifold.



111. Install 3 of the provided M6x55 bolts in the thermostat water manifold.

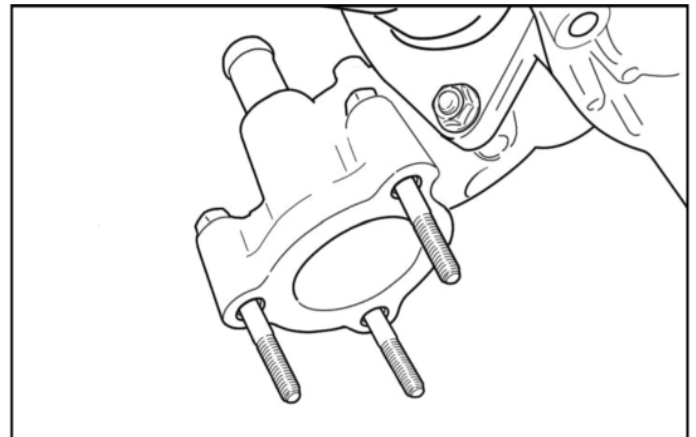

112. Install the supplied large O-ring in the groove of the provided thermostat spacer, a small amount of grease will help hold it in place, and then place the spacer on the 3 bolts with the O-ring facing the thermostat water manifold.

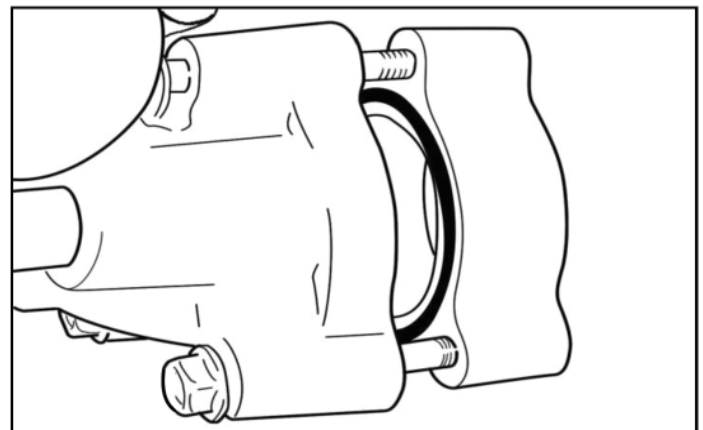

113. Install the thermostat water manifold back onto the engine making sure the 2 O-rings are still in place on the engine. Start the 3 bolts, but do not fully tighten them at this time. **CAUTION: Make sure all O-rings stay in place.** Using the 2 spacers (shown with arrows), place them between the thermostat water manifold and the engine at the 2 remaining mounting bosses and insert the 2 remaining M6x55 bolts.

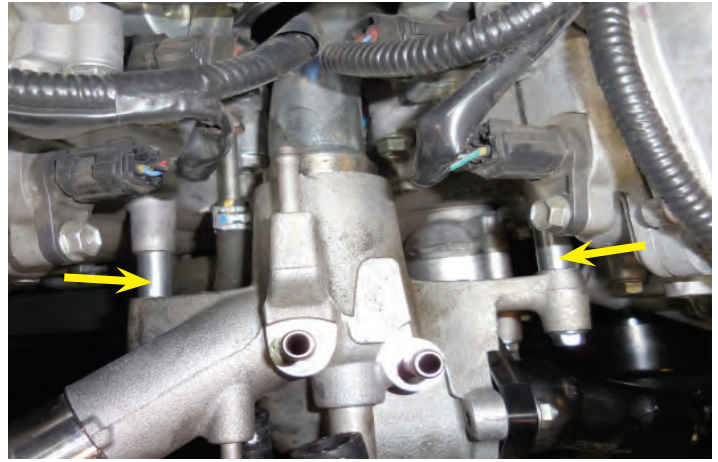

114. Torque all 5 bolts to **9 Nm (80 in lbf)**.



115. If the vehicle has an oil cooler, $\frac{1}{2}$ " will need to be cut from the ends of the coolant lines where they attach to the thermostat water manifold (highlighted in green).



116. Here the hoses from the last step are being cut.

CAUTION: IF THIS STEP IS OMITTED, THE HOSES WILL HIT THE FAN.



117. Reconnect all hoses, except for the radiator hoses, to the thermostat water manifold using the OEM spring clamp.



Section 7: Heater Hose Modifications

118. Note the position of the existing heater hoses and how they connect to the heater core.

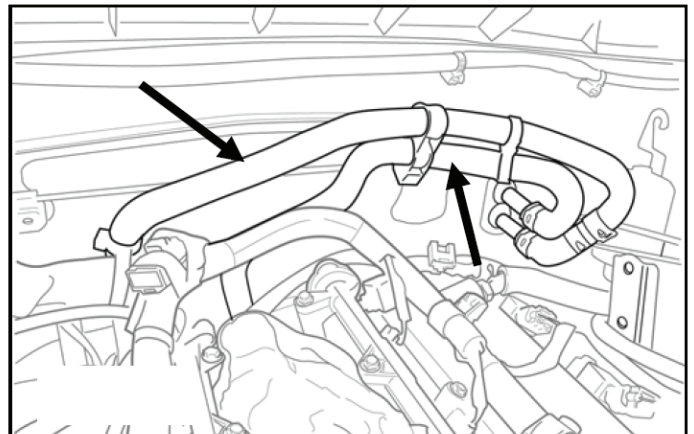

119. Disconnect the two heater hoses from the heater core barbs. Remove and retain the 4 hose clamps and the one mender for use later.

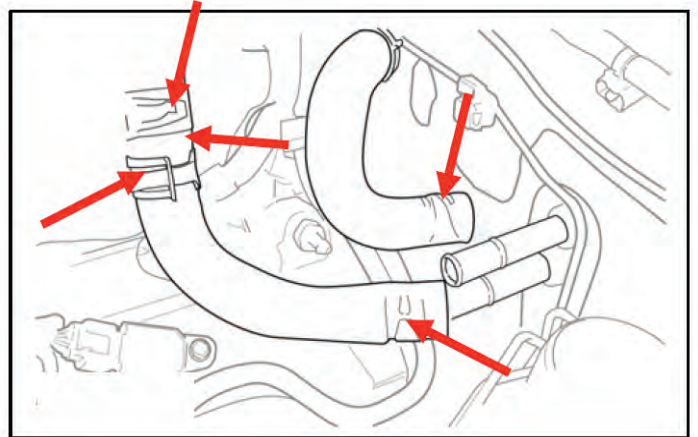

120. Remove the hose spacers, discarding the larger one and keeping the smaller one. Remove the metal bracket supporting the wire harness. Make certain that the metal bracket is not attached to either the heater hoses or the wiring harness.

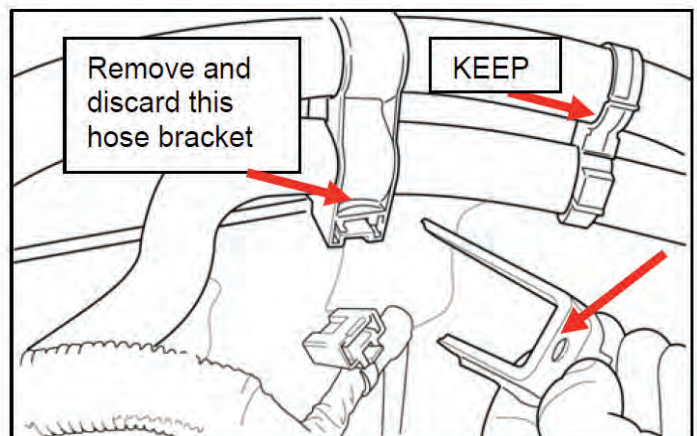

121. Use existing heater hose w/minor modifications. At firewall/heater core trim 1/2" on upper rubber hose (yellow) and 1-3/4" from lower rubber hose (red). This will enable both hoses to get closer to Firewall. Install 5/8" split wire loom as shown.

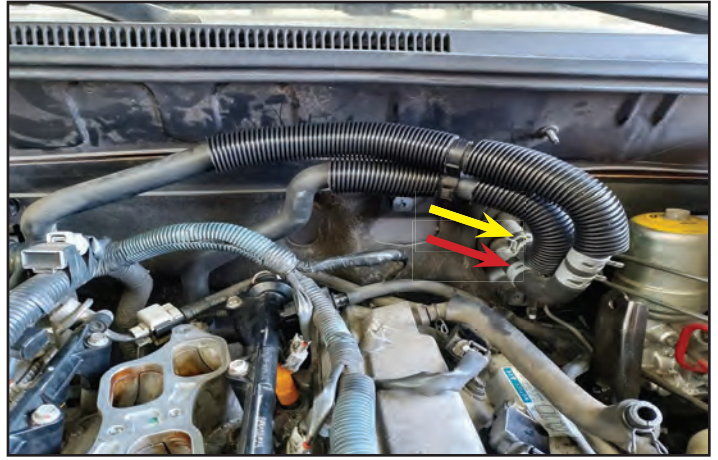

122. Relocate steel Wire Loom Bracket (on Passenger Side) as shown, moving it further towards the passenger side. There is also a second bracket that should be removed to the right or closer to center of vehicle. Both of these changes will give extra flexibility and clearance when installing the main supercharger assembly.



123. On the left side of the engine, remove the rear intake manifold support bracket (surge tank stay No. 2) and replace it with the provided support bracket. Note: the original bracket is stamped with a "C" and the provided bracket is stamped with a "B". Leave the attaching bolt finger tight. Make sure you use the same threaded bolt hole on the engine. If the vehicle has a manual transmission, remount the clutch hydraulic line bracket to the new support bracket.



124. Remove the VSV from the left rear side of the original intake manifold (surge tank). Keep the VSV and bolt for the next step.

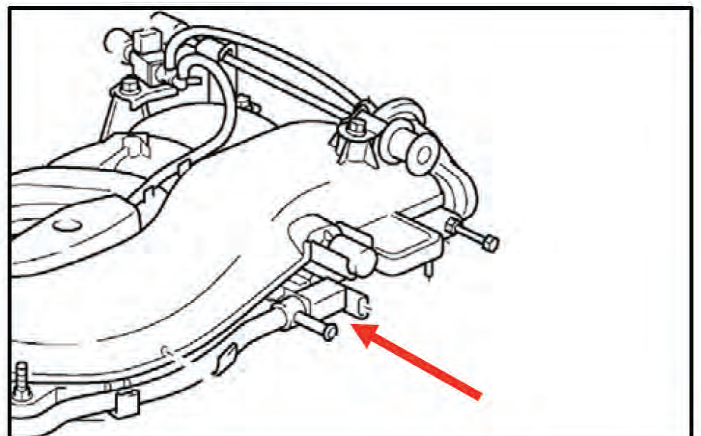

125. Attach the VSV to the supplied VSV Bracket using the stock bolt and a supplied M6 nut. Mount the VSV/VSV bracket subassembly to the front stud of the oil filler cap housing. Remove the stock nut, install the M6 washer, the bracket-valve assembly, and reinstall the nut. Torque this nut to **9 Nm (80 in lbf)**.

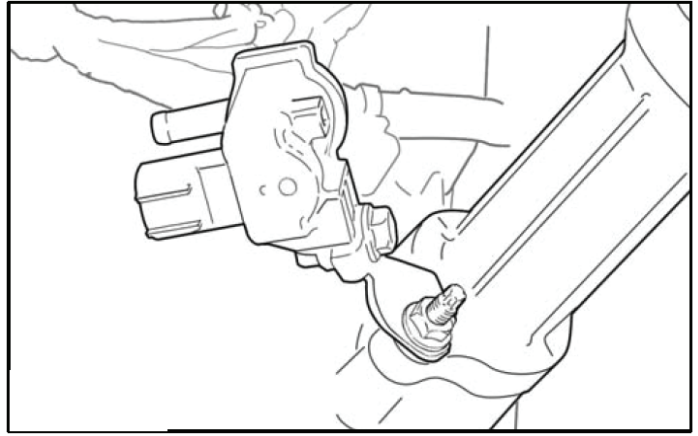

126. Plug in the electrical connector to the VSV.

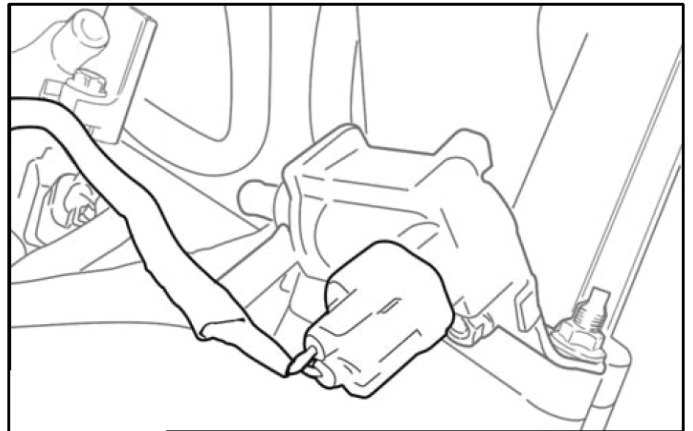

127. The fuel vapor hoses were originally connected to the VSV as shown. Disconnect these hoses and reconnect them as shown in the next two steps.

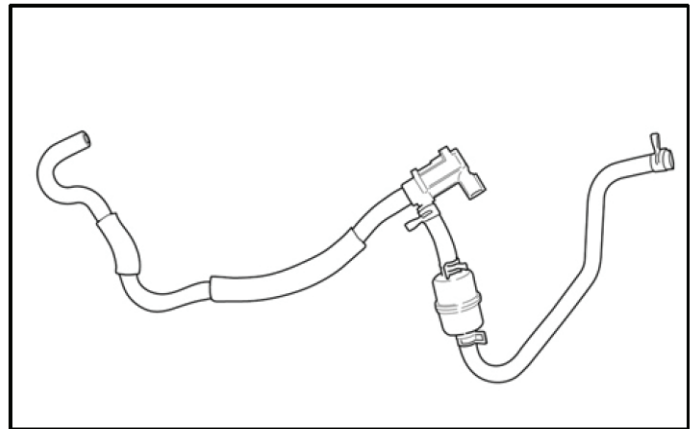

128. Hose end A attaches to the hard vapor line shown in the next step. Leave hose end B loose for now. Hose end B will be attached to the supercharger in a later step.

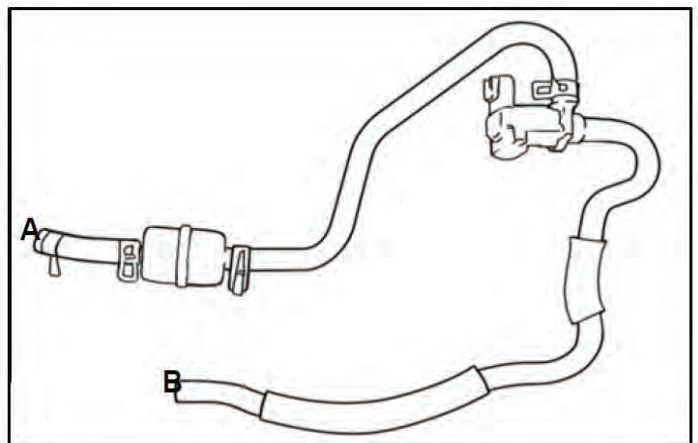

129. This illustration shows the connections for the vapor lines from the last step.

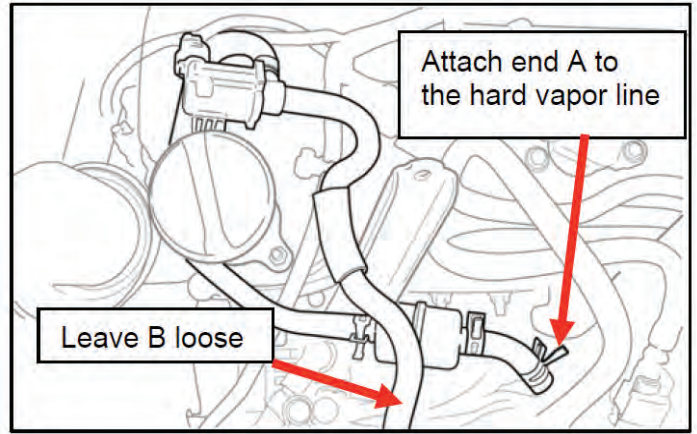

Section 8: Supercharger Preparation and Installation

130. Remove the throttle body O-ring from the intake air surge tank (shown with an arrow).



131. Here is the throttle body O-ring. Clean the O-ring and inspect it for any damage. Replace as necessary. Note the tab on the O-ring that will be aligned with the slot on the new intake manifold.



132. Install the throttle body gasket at the location shown on the supercharger assembly. Ensure that the alignment tab is positioned properly.



133. Remove the intake port gasket from the OEM air intake surge tank. **CAUTION: Do not damage the port gasket.** If the gasket appears to be damaged or excessively worn, replace the gasket with Toyota part number 17176-0P010 or 17176-31010 or equivalent superseded part. Install the intake gasket on the supercharger housing (shown in this photo). The molded gasket and O-ring should fit snugly in the grooved recesses in the housing.



134. Turn the supercharger housing upright and remove the 12 M6 bolts that attach the top cover. Retain these bolts. **CAUTION: Do not remove the larger bolt between the two coolant barbs (location shown with red arrow).** Record the serial number which is located at the yellow arrow location. The serial number is also located on the shipping box.



135. Carefully lift the cover up removing it from the main housing. Note: the charge air cooler will come out attached to the cover. It is bonded to the cover. **DO NOT SEPARATE it from the lid.** Set the assembly upside down so the foam seal is not damaged. The sealing O-ring should remain in the groove in the main housing.



136. Preinstall the provided 6 special reduced diameter shank M8 intake manifold bolts by threading them into the main housing. By reinstalling these bolts into the housing, the possibility of dropping them into the engine ports is reduced. When the bolts are fully threaded in, they will float up and down on reduced diameter shanks.



137. Disconnect and remove the 2 harness clamps on the left side valve cover (one is shown with the arrow).

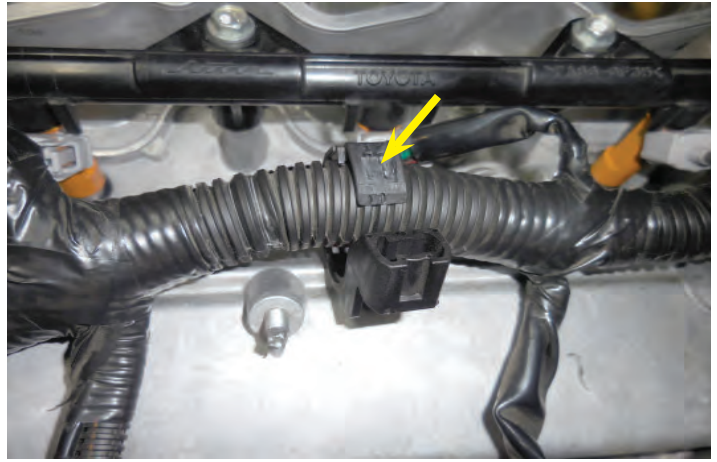

138. Move the electrical harness away from the stud locations that they were mounted to as shown in this photo.



139. Remove the tape covering the intake ports in the engine manifold. Make sure the surface is clean and that all obstructions have been removed.



140. Carefully, position the supercharger main housing on the intake manifold and hand start the 6 bolts. Do not tighten at this time. **CAUTION: Before proceeding, pull the heater hoses out from under the rear corner of the supercharger housing.**



141. Install the original 2 bolts that attach the support brackets (2 surge tank stays) to the supercharger housing. Do not tighten.

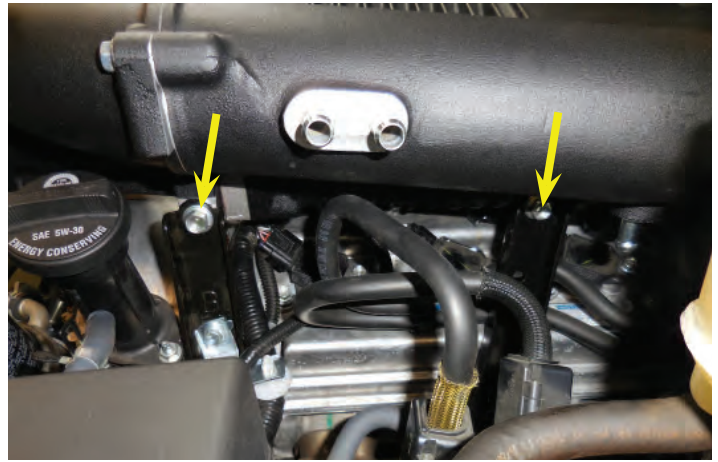

142. Lightly tighten the two lower bolts that attach the 2 surge tank stays to the engine.



143. Using the 3 provided M8 bolts, install the upper idler bracket assembly to supercharger housing (2 places) and the engine cylinder head boss (1 place). Do not tighten.

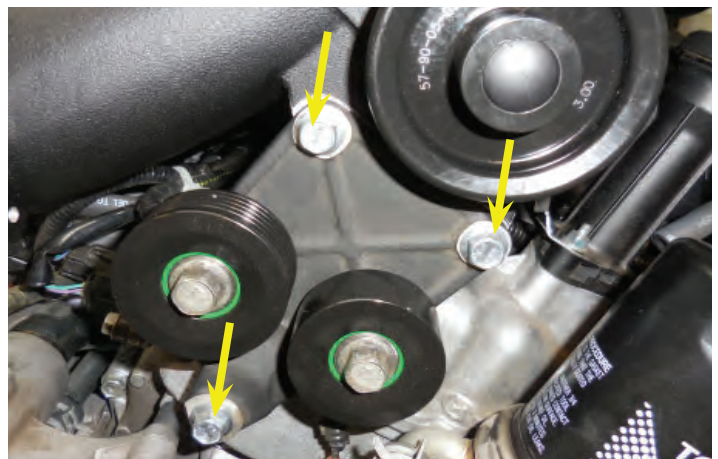

144. Torque the manifold bolts to **28 Nm (21 ft lbf)** starting from the center and working your way outwards in a criss-cross pattern.



145. Torque the 2 side support brackets at the top and bottom to **28 Nm (21 ft lbf)**.



146. Torque the 3 bolts on the upper idler assembly and the 2 M10 nuts on the lower supercharger belt tensioner assembly to **28 Nm (21 ft lbf)**.



147. After checking to make certain the large O-ring is properly seated in the groove in the main housing, carefully re-install the supercharger housing top cover by lowering it straight down. Fasten with the original 12 M6 bolts. Torque these bolts to **12 Nm (9 ft lbf)**
CAUTION: If the O-ring ends have separated, place a small spot of black RTV over the area where they join before placing the lid in position.



148. Finish installing the supercharger belt drive making sure the routing is correct. There is a larger version of this diagram at the back of this manual.

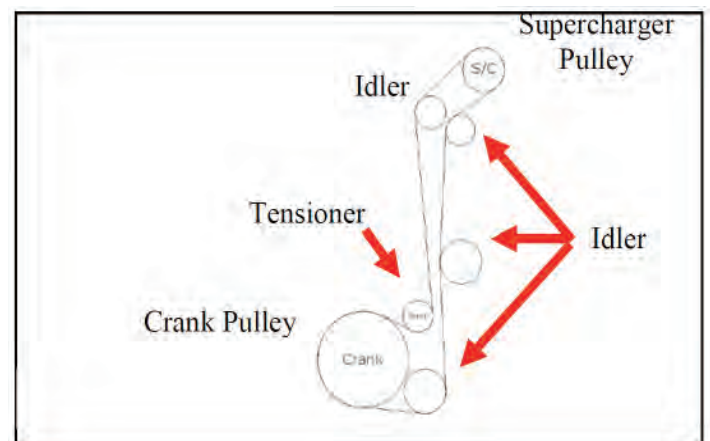

149. Here the supercharger belt drive is being installed.



150. Remove the cardboard from the back of the radiator.



151. Re-install the fan and radiator shroud and tighten all fasteners. Ensure that the tabs at the bottom of the fan shroud engage into their slots. **Torque the fan nuts to 21 Nm (15 ft lbf). Torque the shroud bolts to 5 Nm (44 in lbf).**



152. Re-install the top radiator hose using the OEM clamps.



153. Install the throttle body to the supercharger housing. Torque the 4 bolts to **11 Nm (8 ft lbf)**.



154. Re-connect the coolant hoses from the throttle body to the thermostat water manifold.

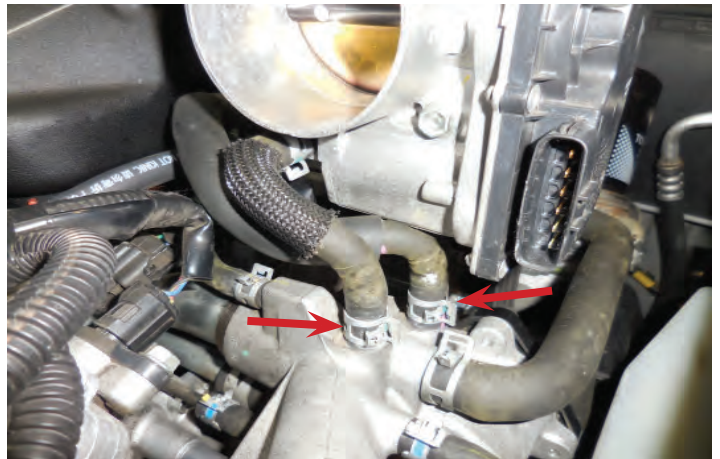

155. Place a clean rag over the throttle body to prevent dirt from entering the intake.



156. Using the OEM spring clamps, install the provided lower radiator hose. **CAUTION: Turn the clamps so they do not hit the fan or the belt.**

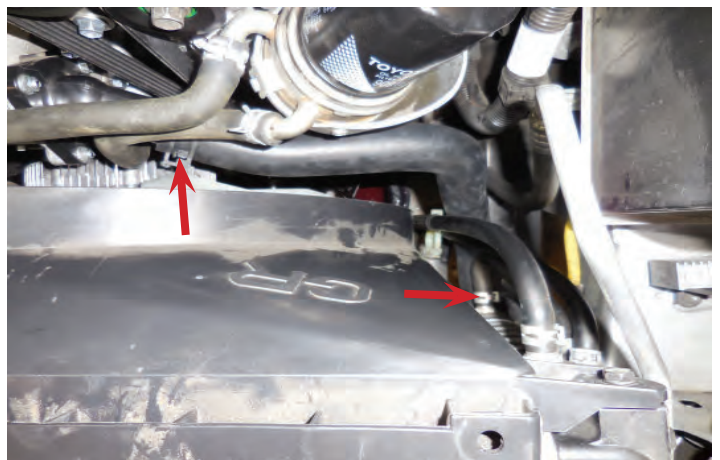

157. Reconnect the hose clamp to the two hoses shown with the arrow.

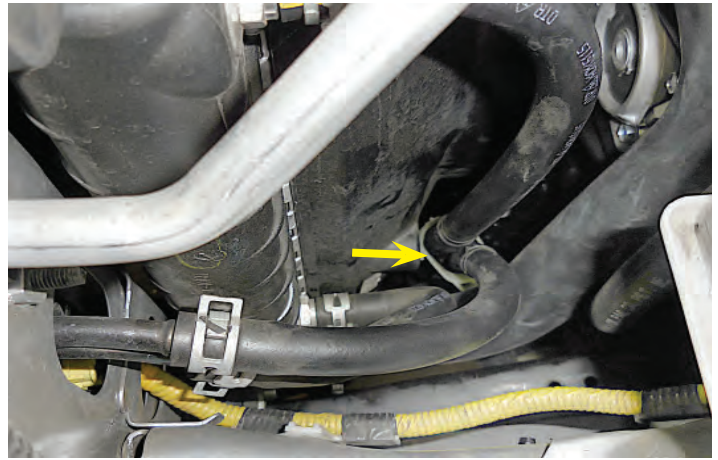

Section 9: Intercooler Pump Installation

158. Disengage the 4 claws and remove the plastic hood lock release lever protector.

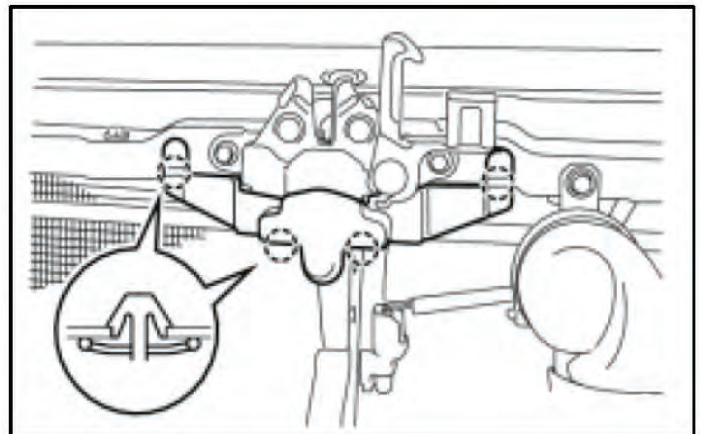

159. Remove the 3 bolts and the hood lock assembly. Remove the Temperature sensor from the radiator support. Let the hood lock assembly hang loose on the cable. Retain these parts.

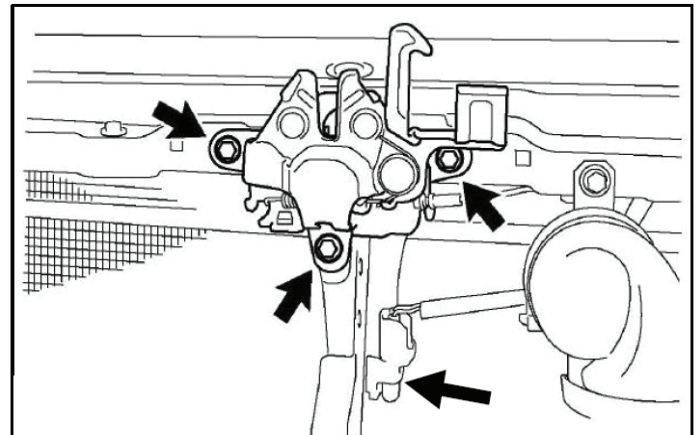

160. Disconnect the electrical connector and remove the horns. Retain these parts.

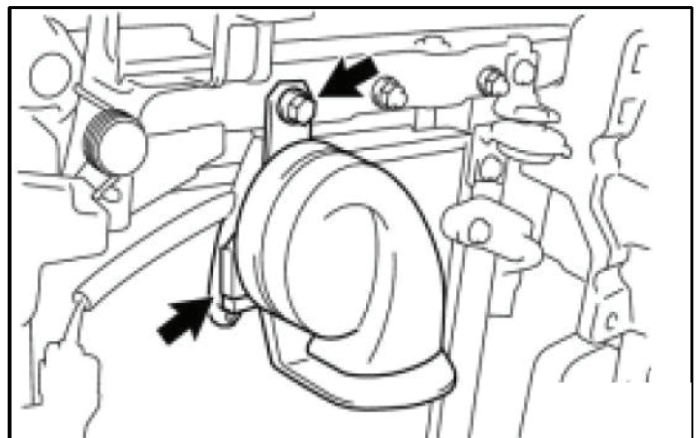

161. Remove the 3 bolts that attach the hood latch support bracket to the bumper and radiator supports. Save these fasteners. The bracket will be replaced by the new bracket supplied in the kit.

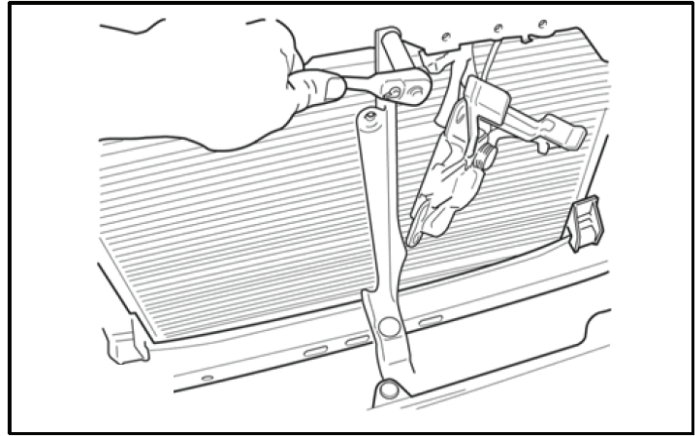

162. The AC condenser is mounted at 4 locations, 2 at the top and 2 half way down. Locate the two No. 2 cooler condenser cushions and remove the upper bolt from each. Save these bolts.

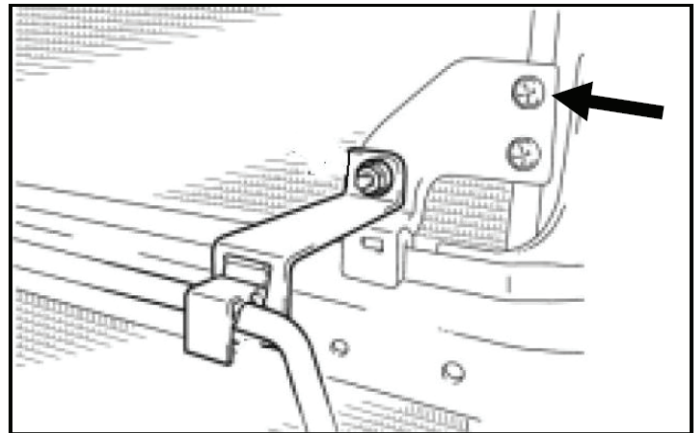

163. Remove and save the bolts from the two upper No. 1 cooler condenser cushions.

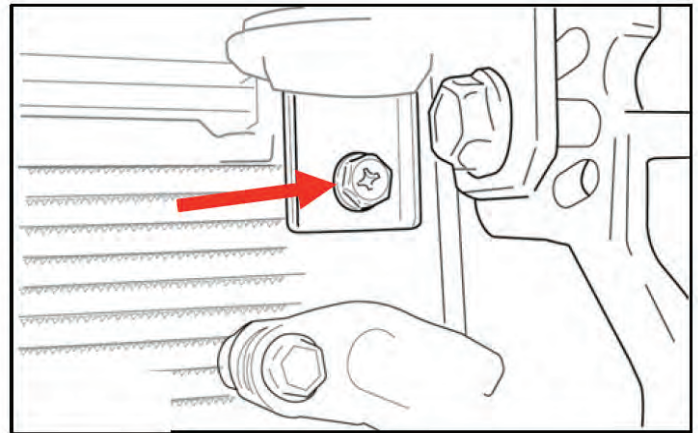

164. Place the provided Low Temperature Radiator (LTR) in position in front of the AC condenser as shown. **Ensure that the plastic plugs are removed from the upper and lower spigots on the LTR at this time.** The upper and lower mounting tabs on the LTR align with the bolts removed in the past two steps. Ensure that the plugs for the spigots have been removed from the LTR.

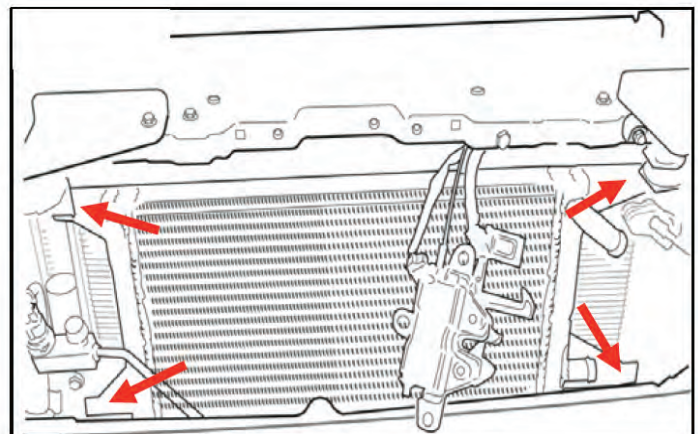

165. Reinstall the original condenser mounting bolts capturing the LTR mounting tabs between the AC condenser and the condenser cushions. **Torque these bolts to 5.5 Nm (49 in lbf).**

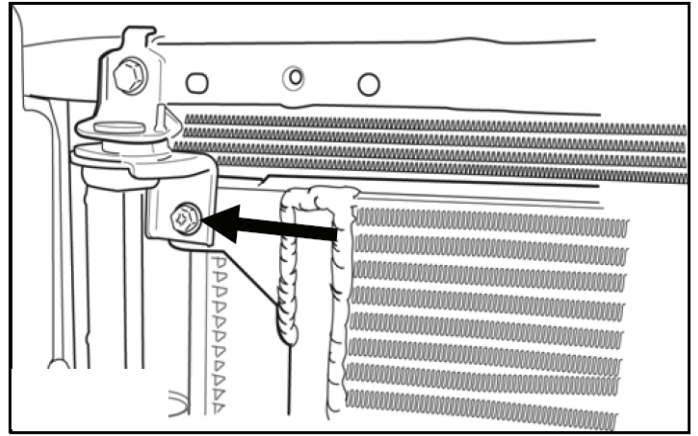

166. This image shows the lower mounting location for the LTR. **Torque these bolts to 5.5 Nm (49 in lbf).**

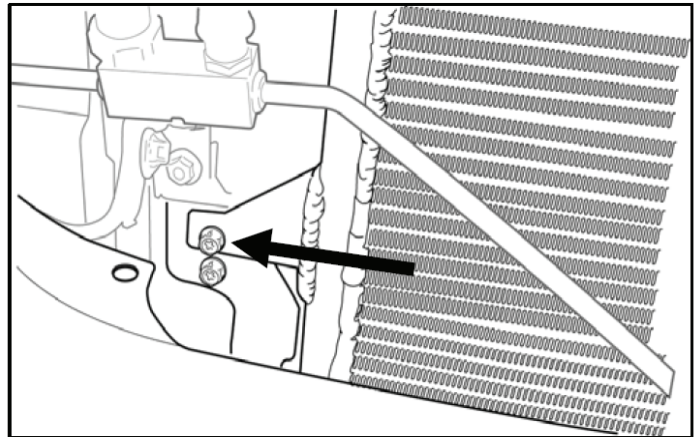

167. Mount the intercooler pump to the provided hood support bracket using the two large provided #35 Adel Clamps and M6X16mm Hex Flange Head Bolts. Do not tighten the fasteners at this time. **HINT: It helps to hand shape the Adel Clamps to the shape of the pump**

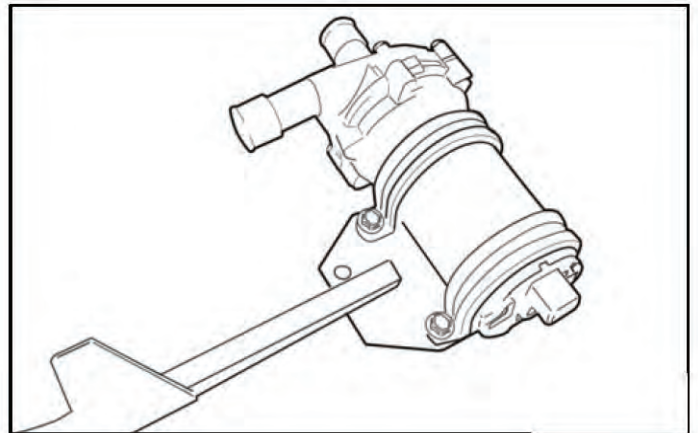

168. Install the new hood support bracket/pump assembly with the original fastener. **Torque: 8 Nm (71 in lbf)**

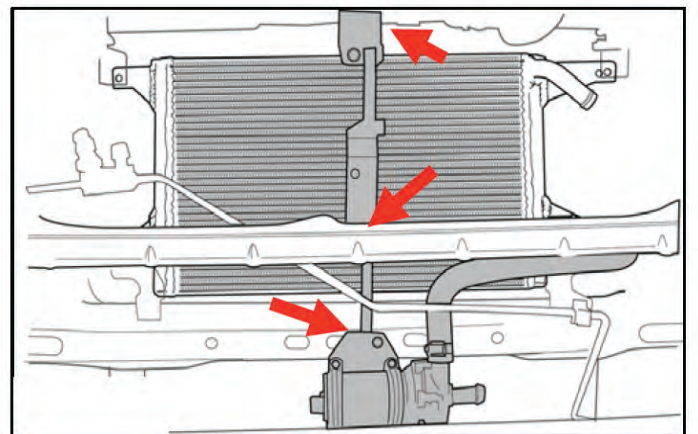

169. Reinstall the hood lock assembly. Torque these three bolts to **8 Nm (71 in lbf)**. Reinstall the temperature sensor to the new hood latch bracket.

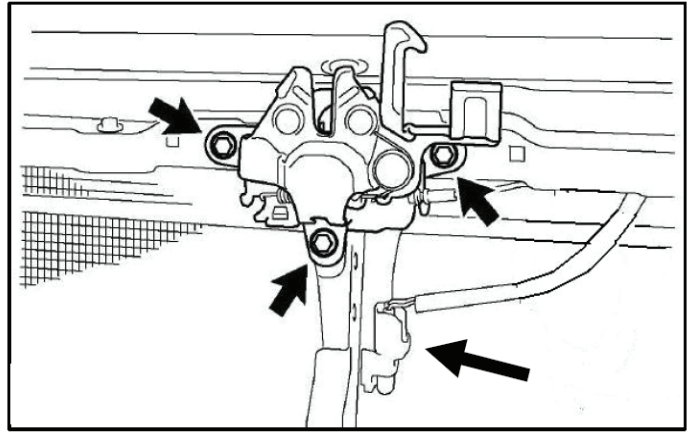

170. Trim the plastic hood lock release lever protector as shown.

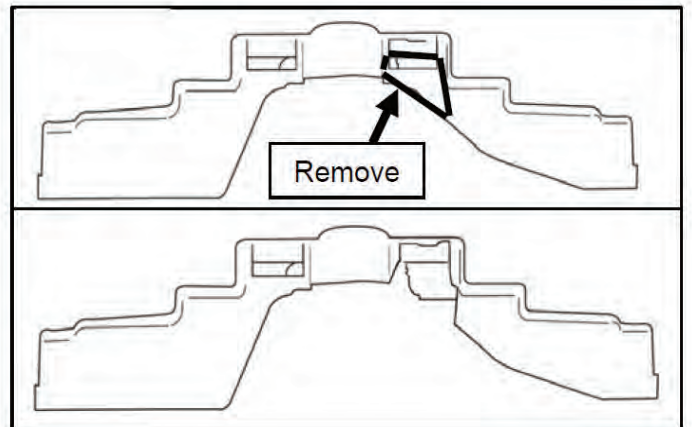

171. Reinstall the hood lock release lever protector.

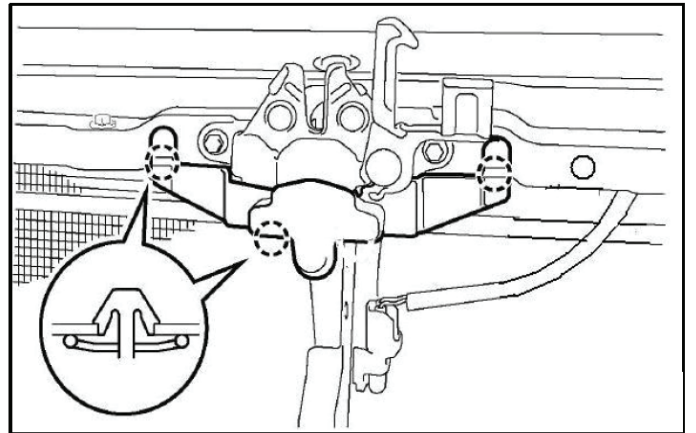

172. Mount the drivers side horn (red arrow) with a 2-1/8" spacer and a M8x70mm Hex Bolt. Arrange as shown to get maximum clearance to Upper LTR Hose Barb. Re-mount the passenger side horn (yellow arrow) with the provided spacer, and M8X30 mm bolt as shown. Torque these bolts to **9.8 Nm (7 ft lbf)**. Reconnect the electrical connector to the horns. In order to attach additional wiring to the drivers side horn, some tape on the wiring loom may have to be re-positioned to get additional wire length.

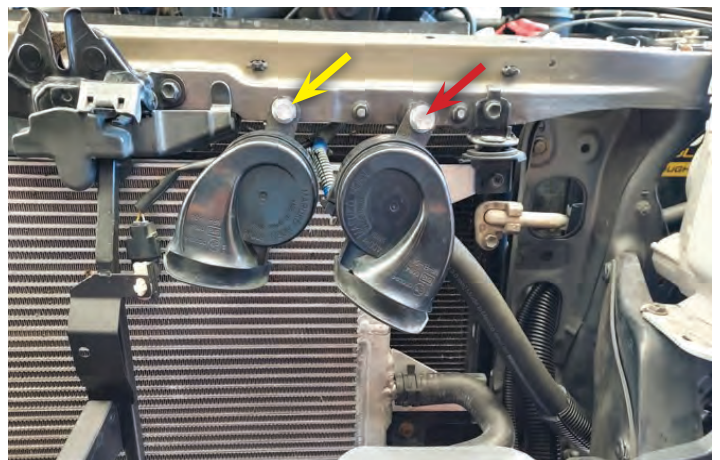

173. After making sure the outlet on the pump points straight up, tighten the mounting bolts. Torque these mounting bolts to **12 Nm (9 ft lbf)**. Slide a wide band spring clamp approximately 2" onto each end of the LTR to pump formed coolant hose. Install this hose to the lower outlet on the LTR and the pump outlet and position each clamp to hold it in place.

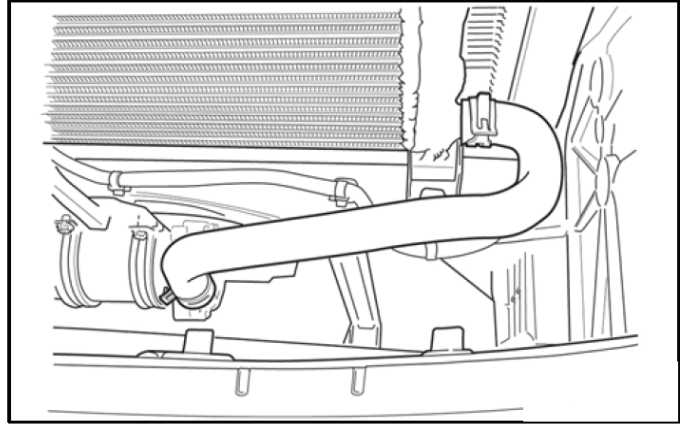

Section 10: Intercooler Reservoir and Hose Installation

174. There are 2 holes in the lifting bracket for the brake master cylinder. They will be used to mount the intercooler coolant reservoir. The forward most of the two holes has an M6 weld nut attached to the lifting bracket.

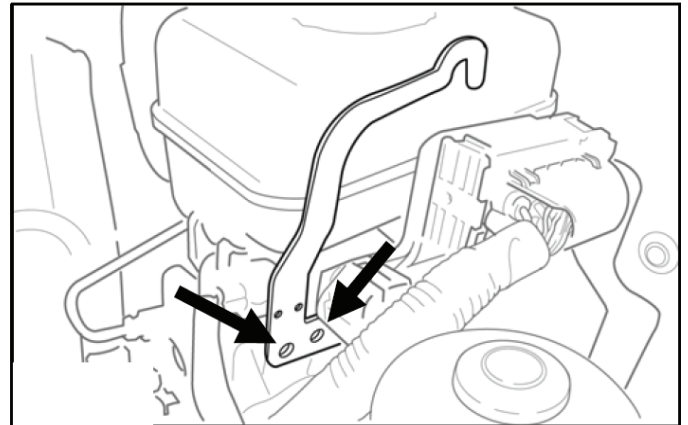

175. Using 2 provided M6x20mm bolts and 1 M6 nut, mount the intercooler reservoir bracket to the 2 holes (one location shown with the red arrow) in the lifting bracket. Torque these bolts to **5.5 Nm (49 in lbf)**. Remove the two bolts shown with the yellow arrows to use as mounting locations for the second reservoir bracket shown using the provided M8x20mm bolts and torque them to **8 Nm (71 in lbf)**.

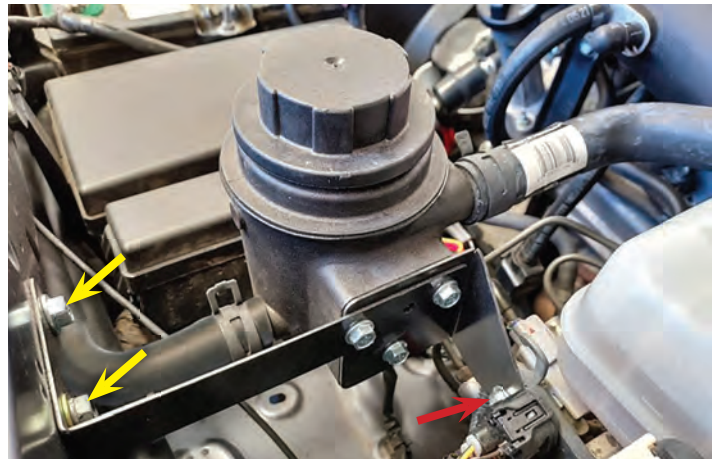

176. Using 3 provided M6x12mm bolts (green arrows), mount the intercooler reservoir tank to the reservoir bracket making sure you capture the brace that was just installed to the fender panel. Torque the M6 bolt to **4 Nm (35 in lbf)**.



177. Before proceeding with the remainder of the hose plumbing, study this hose routing diagram.

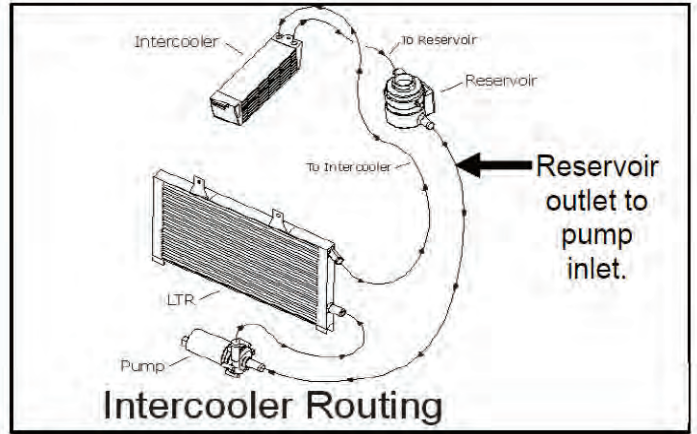

178. Coolant Hose, Reservoir to Pump Inlet:
Take a 4" x 60" 90-deg hose and cut the short end to 3" while leaving the 60" intact at this time.

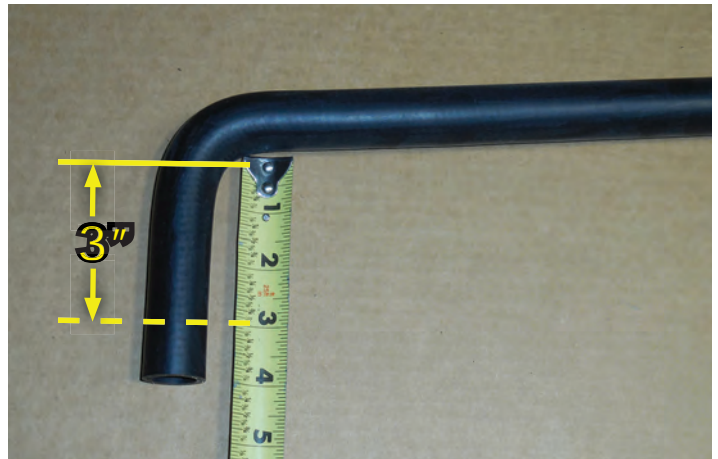

179. Install roughly 36" of split wire loom on long end of hose.



180. Install short end of the hose from the last step on lower reservoir outlet (highlighted in green) and secure with spring clamp.

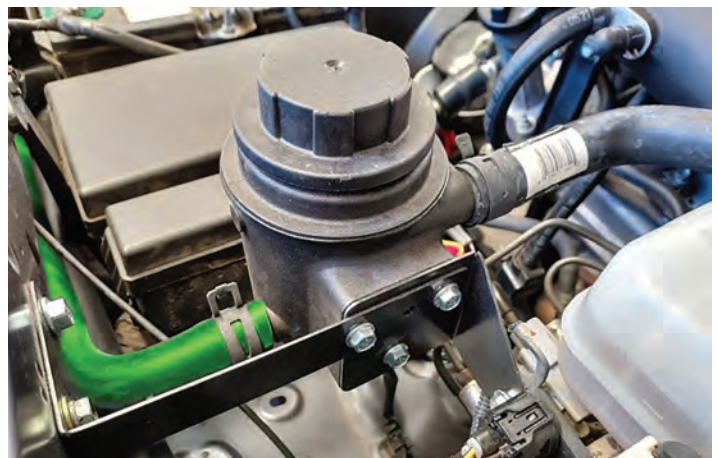

181. Route long section of hose behind Fuse Box and Battery (highlighted in green). **HINT: It is easier to route the hose if you unbolt the fuse box and temporarily move it inboard a little.**



182. Continue routing of hose highlighted in green through front bulkhead (though lower hole on driver side of radiator as shown).

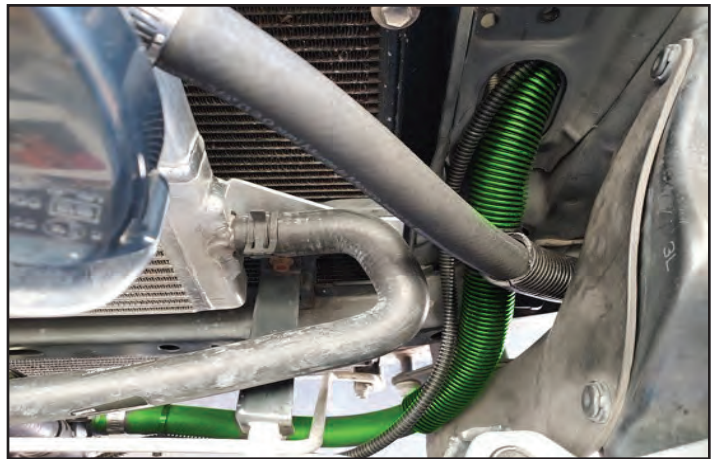

183. Route the end of the hose from the last step to the inlet of the intercooler pump. Trim the hose to length and secure it to the pump inlet with a wide band spring clamp.

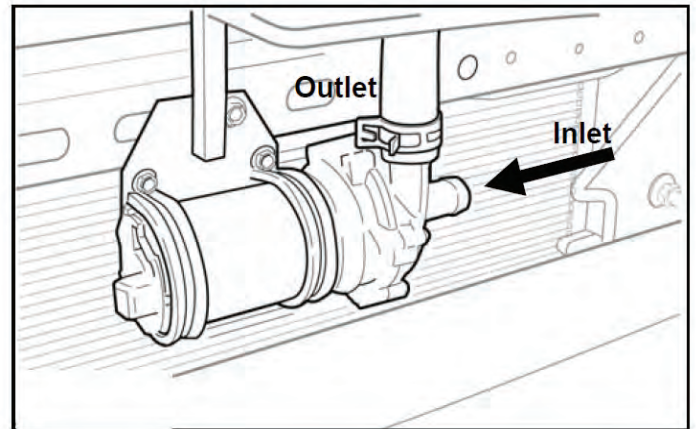

184. Cut a 4" x 60" hose to 2.5" x 51".



185. Install 18" of split loom approximately 12" from short end on the 2.5"x51" hose from the last step.

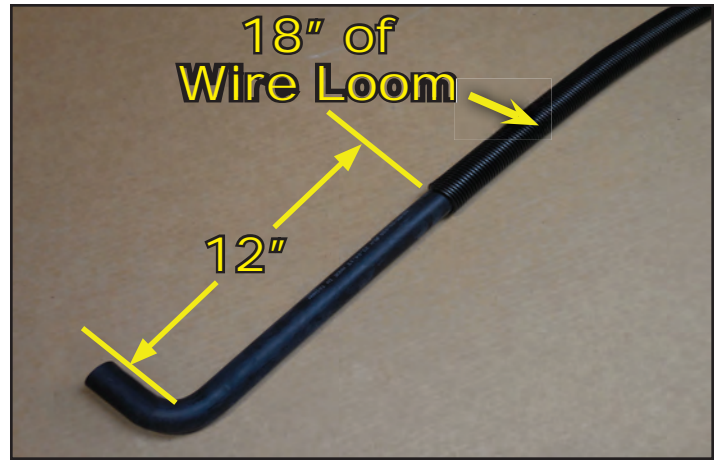

186. Cut a 40" piece of hose from the remaining 4" x 60" molded hose (save the remaining hose) and attach the 40" straight hose to the 2.5"x51" hose with a 3/4" hose mender and two spring clamps.

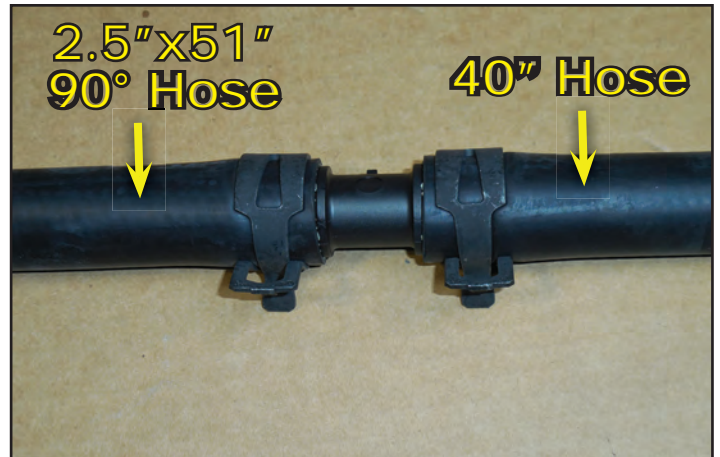

187. Install 30" of split loom on 40" hose from the last step as shown here.



188. Install the 2.5" leg of the hose assembly from the previous step to the right side intercooler fitting on the supercharger housing top cover shown. Secure it with a provided wide band spring clamp.

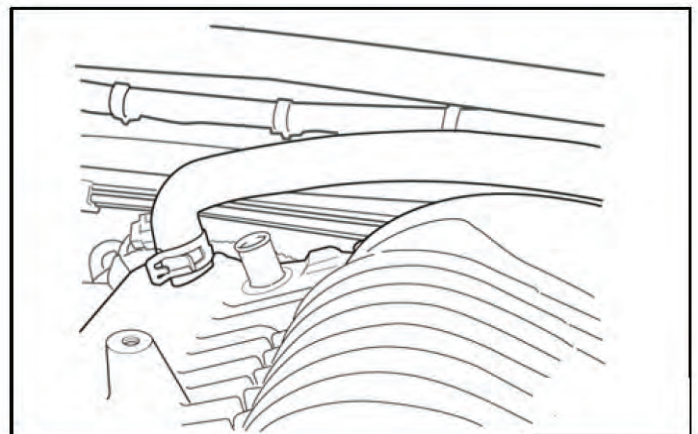

189. Route the hose assembly from the previous step across the firewall, behind the brake master cylinder, and along side the earlier hose assembly behind the fuse box and battery.

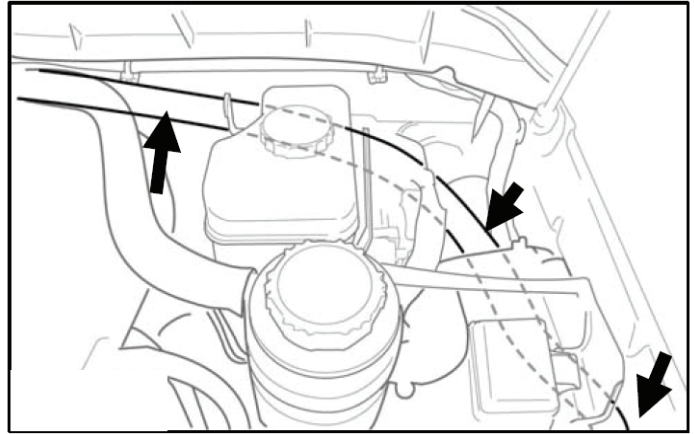

190. Continue routing the hose from the last step under the headlight as shown here highlighted in green.



191. Cut the hose from the last step (highlighted in green) so it connects to the upper LTR barb (red arrow) and secure with a provided hose clamp.

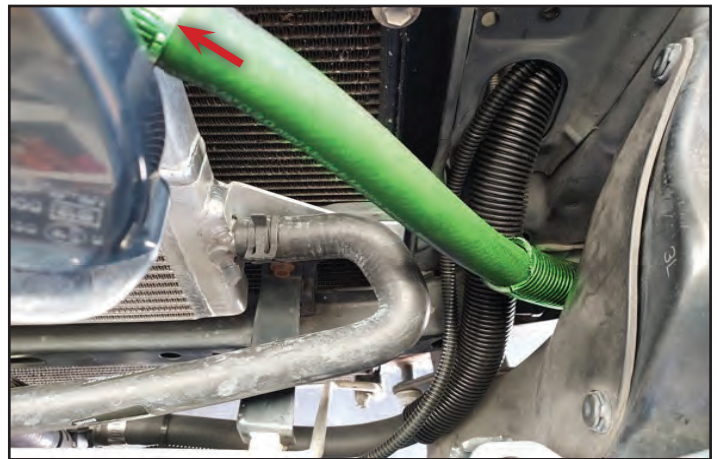

192. Gather the 4"x60" hose that had 40" cut from it. Cut the hose to 2.5" x 9.5" as shown here. Then connect it to the CAC spigot on the supercharger and secure it with a provided spring clamp.

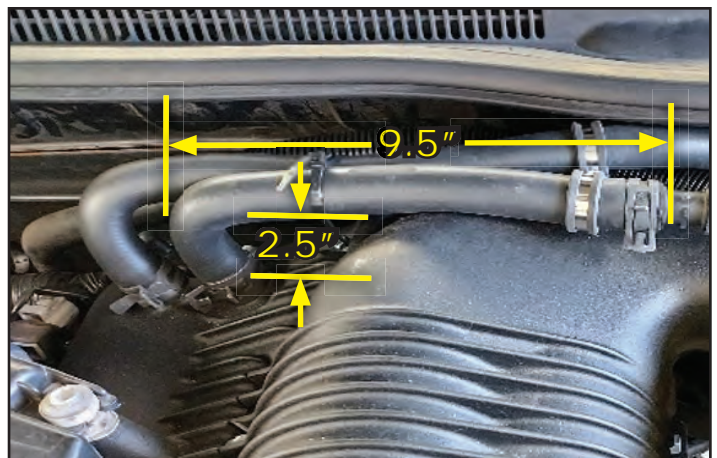

193. Cut one end of the Molded "S" Hose to 4.5" so that the center section of the "S" fits between Inlet Tract and Brake Reservoir. Join with 3/4" hose mender and attach as shown in photo. Connect the other end of the "S" hose to the reservoir and secure with a provided spring clamp. Secure both hoses (coming to and from CAC) with Single loop clamps under a single bolt at rear of supercharger housing.

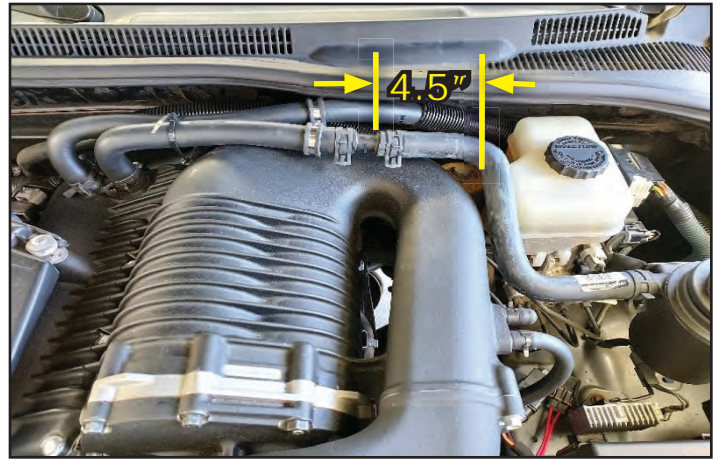

Section 11: Intercooler Pump Wiring Connections

194. Using the supplied M6x20 bolt preassemble the intercooler relay to the Fuse housing as shown.

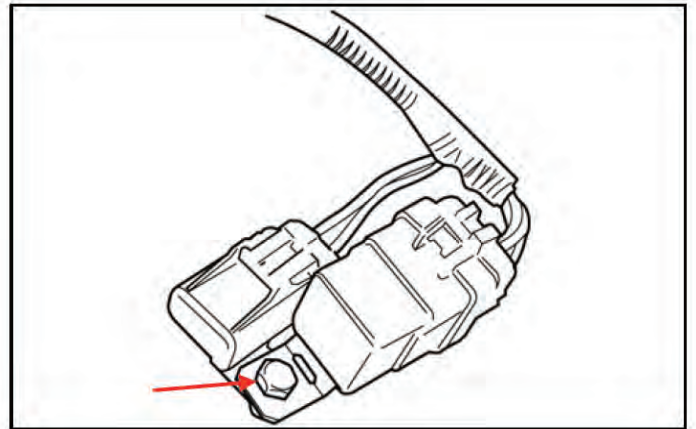

195. Remove the bolt retaining the vehicle ground wire to the fender, take the ground wire from the intercooler pump relay and install it over the vehicle ground wire and reinstall the bolt.

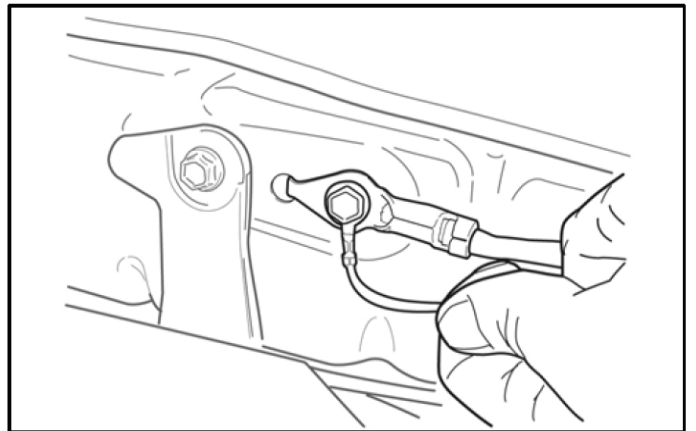

196. Route the two wire connector (red and black wires) through the opening in the radiator support bulkhead.

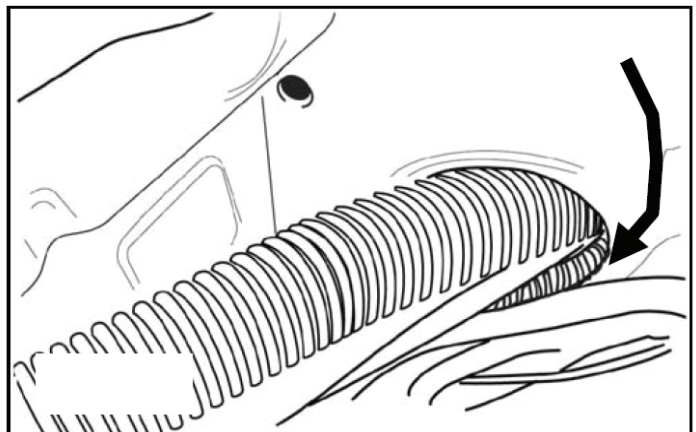

197. Plug the two wire connector into the intercooler pump. Secure the extra wire with tie-wraps

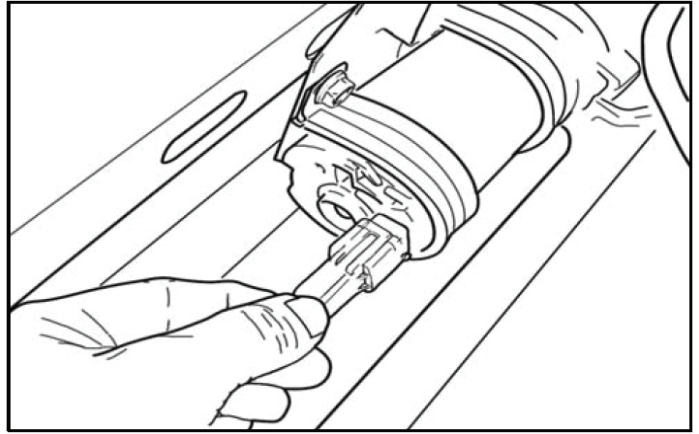

198. Route the wire harness containing the 10 gauge red wire and the yellow wire along the front of the fuse panel from the fender to the inside of the fuse box. Note: the battery is removed for clarity in the figure. Feed both wires up into the fuse box through the same opening used by the vehicle wiring harness.

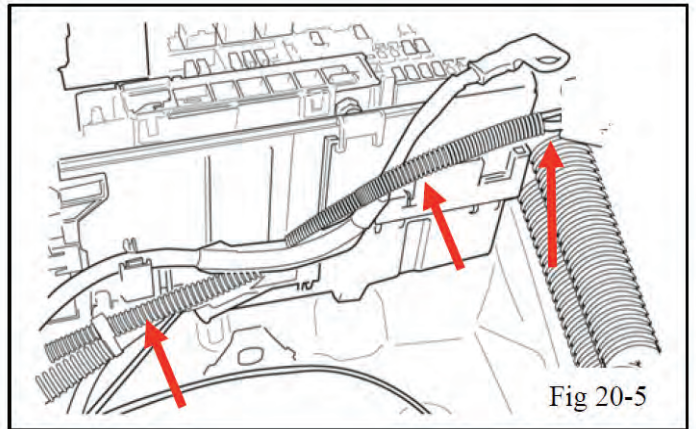

199. Remove the nut that is on the B (+) connection in the fuse panel and connect red wire with the 6mm ring terminal from the intercooler relay to the B (+) terminal in the fuse panel.

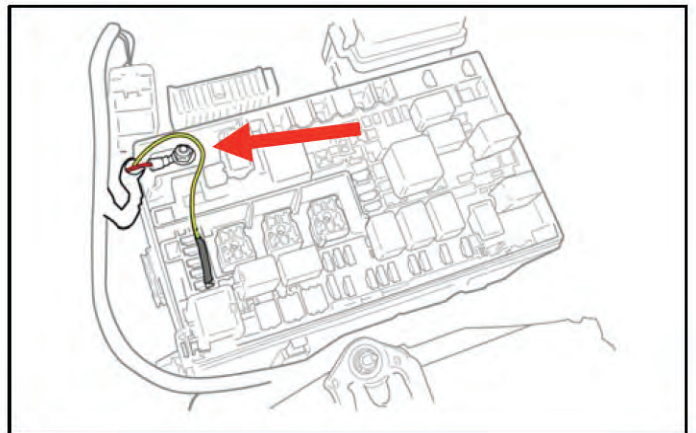

200. Remove the 10-amp mini fuse labeled EFI No. 2.

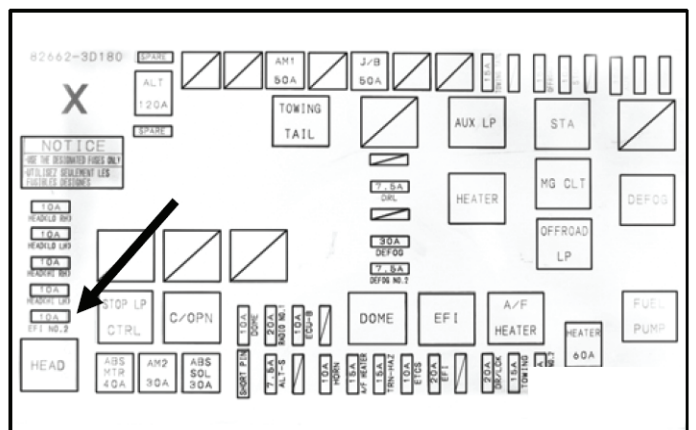

201. Install the T-tap on the original 10 amp mini fuse.

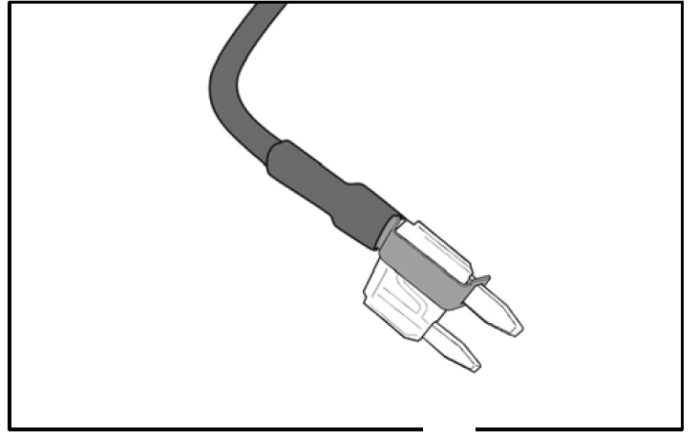

202. Install the fuse with the T-tap back in the same EFI location and then attach the yellow wire to the T-tap. **CAUTION: When installing the fuse, make sure the tap is toward the left side of the vehicle.**

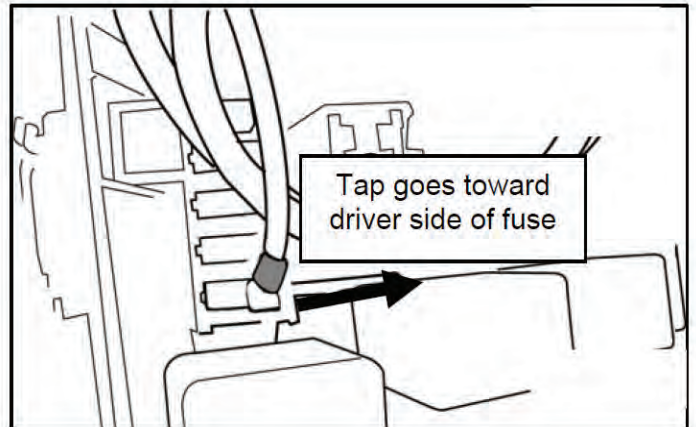

203. Install the 15 amp mini fuse in the intercooler relay fuse holder.

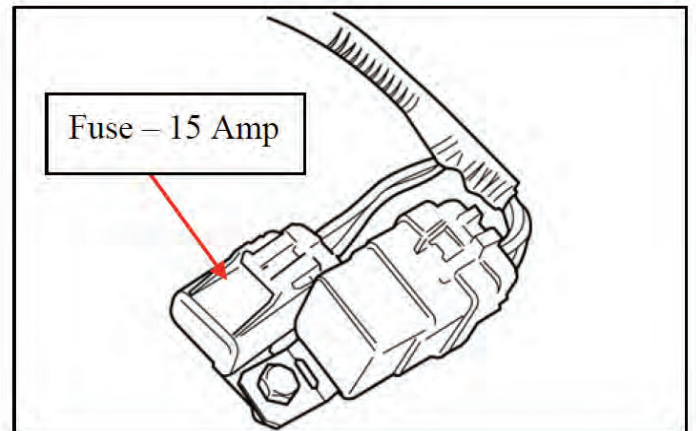

204. Mount the relay/ fuse assembly. Torque this bolt to **8.0 Nm (71 in lbf)**

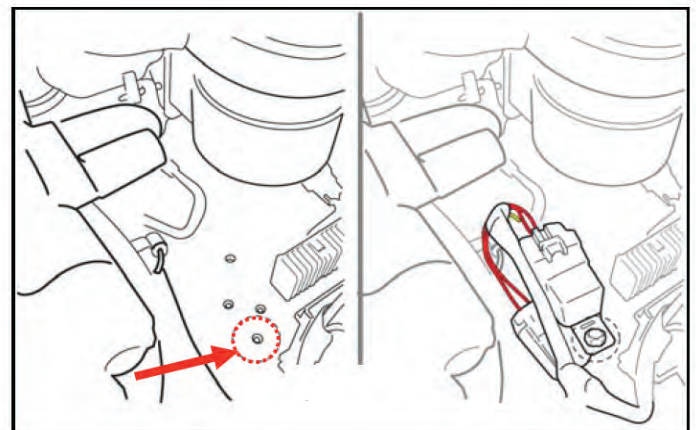

Section 12: Vacuum Hose and Air Cleaner Installation

205. Remove the cap shown with the arrow from the previously removed air surge tank.

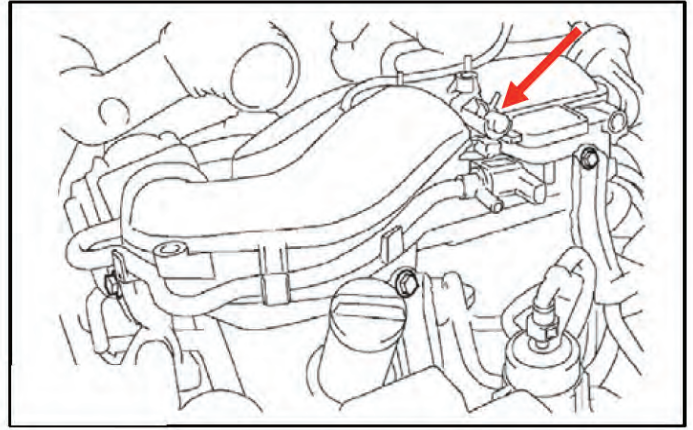

206. Install the cap from the previous step on the forward 3/8" barb (labeled "Vacuum Cap" in this illustration) on the supercharger housing. Connect the EVAP hose that comes from the VSV (Previously referred to as hose end B) to the remaining 3/8" barb on the supercharger housing (labeled "Purge Hose" in this illustration).

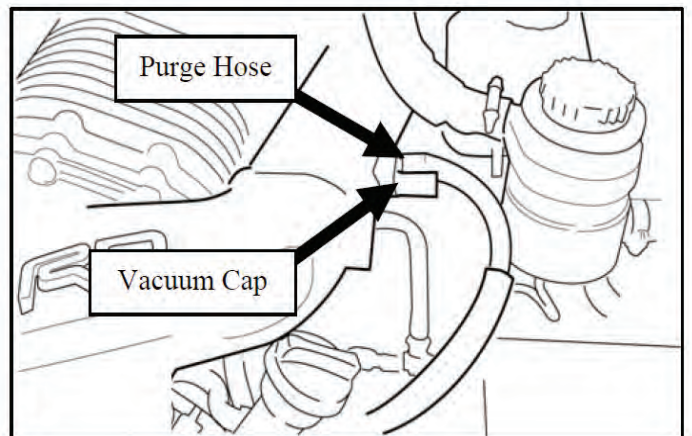

207. Finally, connect the ventilation hose that was disconnected in step #20 to the 3/8" barb that is on the bottom of housing supercharger housing.

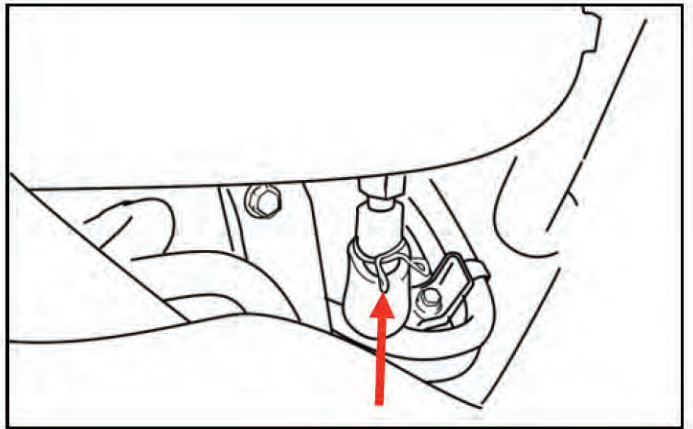

208. Using a M6x16 bolt, install the provided air box bracket to the right side cylinder head cover finger tight.

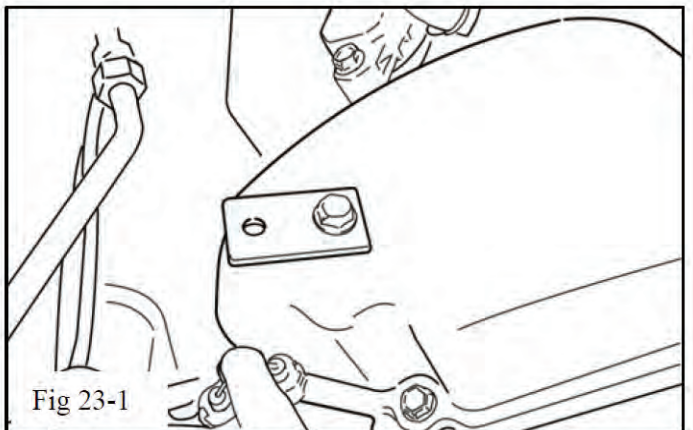
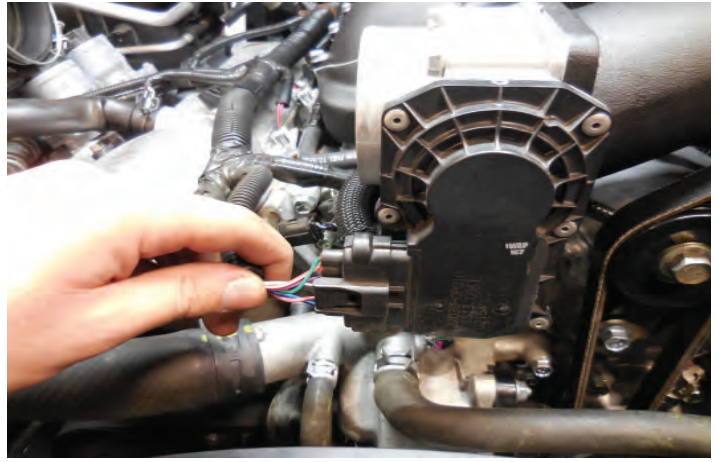

Fig 23-1

209. Plug in the throttle control connection.



210. Release the four clamps holding the air box lid.



211. Replace the OEM filter (on the left) with the provided filter. Secure the lid with the four clamps.



212. Replace the air cleaner assembly in the original location. One fastener location has changed.



213. Gather the two OEM air cleaner assembly fasteners shown.

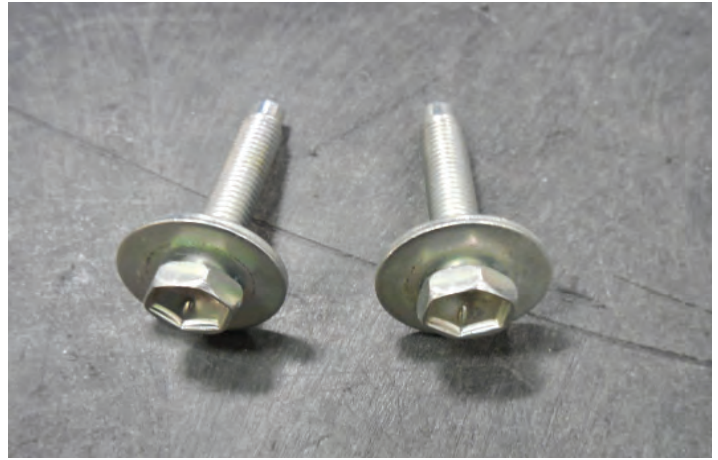

214. Install one of the two fasteners in the last step to the location shown with the yellow arrow. Connect and tighten the two hose clamps shown with green arrows. Plug in the MAF meter shown with the red arrow. Also connect the No. 2 ventilation hose shown with a blue arrow.

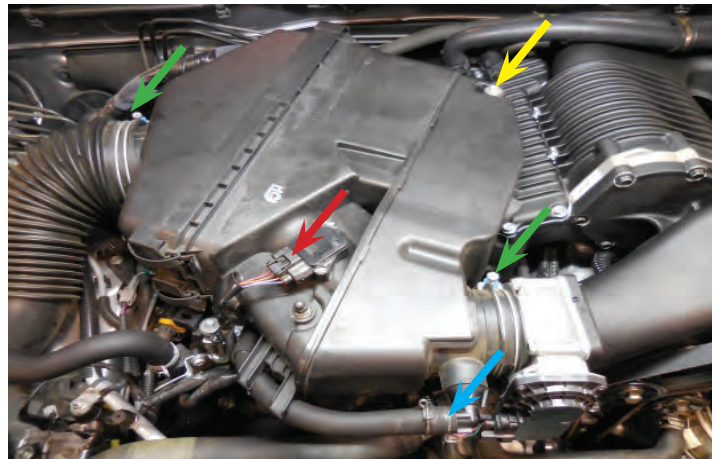

215. The other OEM fastener from two steps ago and a provided M6 nut will be located at the provided air box bracket which was installed on the right side valve cover. Torque these three air cleaner assembly bolts to **8.0Nm (71 in lbf)**.

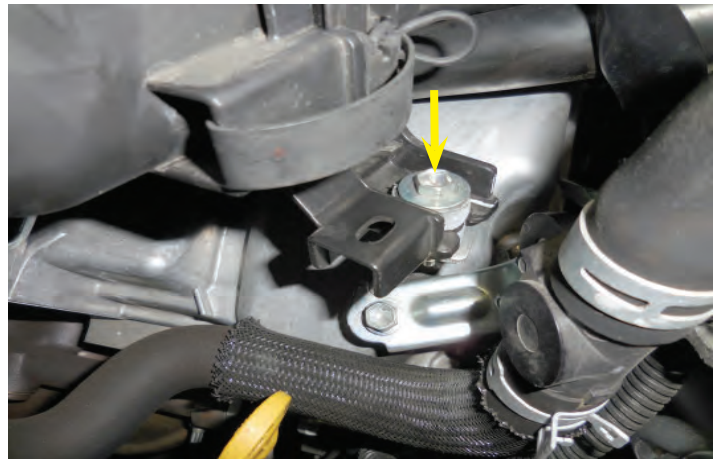

216. Reconnect the 2 wire harness clamps shown.

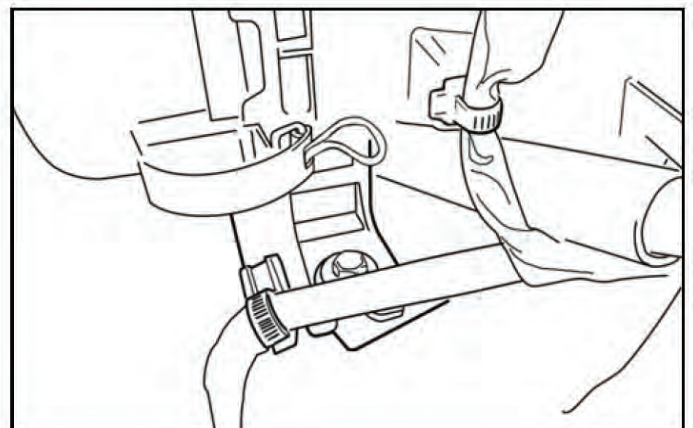

217. Reconnect the vacuum hose that is highlighted in green to the back of the air box assembly.



Section 13: Coolant Fill and Vehicle Testing

218. Ensure that the drain plug for the radiator is closed. Filter the saved coolant that was drained from the radiator earlier, and use that to re-fill the radiator. If you run out of coolant continue to top off with a Toyota approved coolant mixture. Check the coolant level inside the radiator by squeezing the inlet and outlet radiator hoses several times by hand. If the coolant level goes down, add coolant. Install the radiator cap. Slowly pour coolant into the radiator reservoir (shown with a yellow arrow) until it reaches the FULL line.



219. Reconnect the negative lead of the battery.



220. Fill the intercooler reservoir with a Toyota approved coolant mixture until it is full. Have someone else cycle your ignition switch to the accessory mode to trigger the pump on. **Do not start the vehicle!** This will circulate the fluid. Once the reservoir drains turn the pump off, and fill it again. **Do not allow the reservoir to run dry.** Check for fluid leaks. Also check for fuel leaks at this time. Repeat until full circulation is achieved with a full reservoir. Fluid level should be just above the top barb. Re-install the reservoir cap.



221. Check the belts to see that they are properly aligned on all the pulleys. Start the engine and let it idle. Check for fuel, and coolant leaks. Squeeze the inlet and outlet hose on the radiator to remove trapped air from the system. Check the air intake for leaks, and tighten any loose fittings. Shut down the engine, and allow it to cool.



222. Once the engine has cooled down check the level of the radiator reservoir, and the intercooler reservoir. Add coolant if necessary.



223. Reinstall the engine under cover assembly using the 4 OEM bolts.

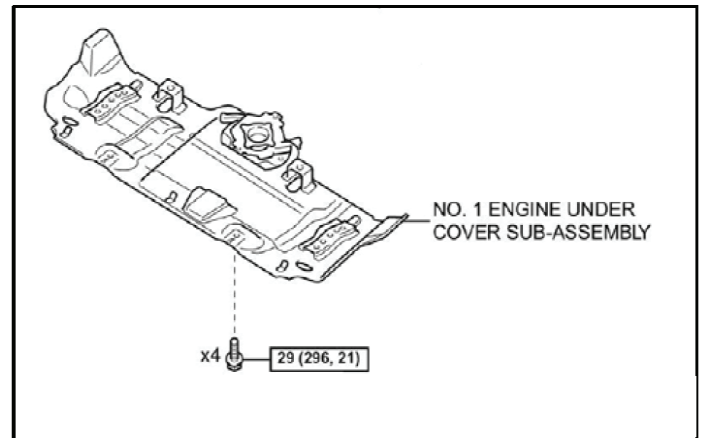

224. The cover (held on with 11 plastic Push Pins) must be clearance for the driver side Horn Spacer. Depending on tools that are available one can either remove some of the plastic with a Die Grinder or File. Once you have sufficient clearance to Horn Spacer, install upper plastic radiator cover.



225. Cut out the Template featured at the back of the Instructions and line up the Template with the bottom of the stock Hood Insulator. Align the vertical edge of the Template with the Driver side of the Insulator center rib (or approx 1" from the center of rib), trace around the Template and cut (standard scissors usually work fine). Since every vehicle is a little bit unique, check to see if there are any abrasions on the two Coolant lines that run along top of the main Supercharger unit (after a few miles). If any are detected, just do a little extra trimming for clearance.

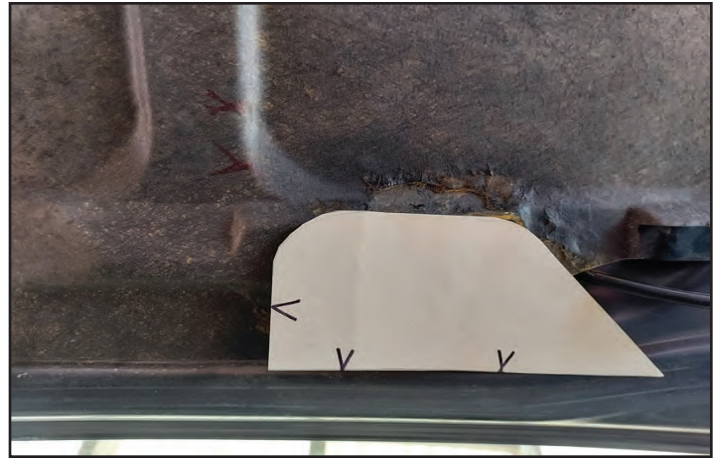

226. Test drive the vehicle for the first few miles under normal driving conditions. **Do not perform any wide open throttle runs.** Check for any unusual sounds, vibrations, or engine misfires. The supercharger does have a slight whining noise under boost conditions, which is normal.



227. After the initial test let the engine cool down, and recheck coolant levels.

228. After the initial test drive gradually work the vehicle to wide open throttle runs. Listen for any engine detonation (pinging). If engine detonation is detected let up on the throttle immediately. Most detonation is caused by low octane gasoline still in the tank. Premium 91 octane fuel is required. Enjoy your new supercharger.



If you have questions about your vehicles performance, please check with your installation facility.

After you finish your installation and road test your vehicle, please fill out the warranty registration. This can be found on our website.

Diagrams

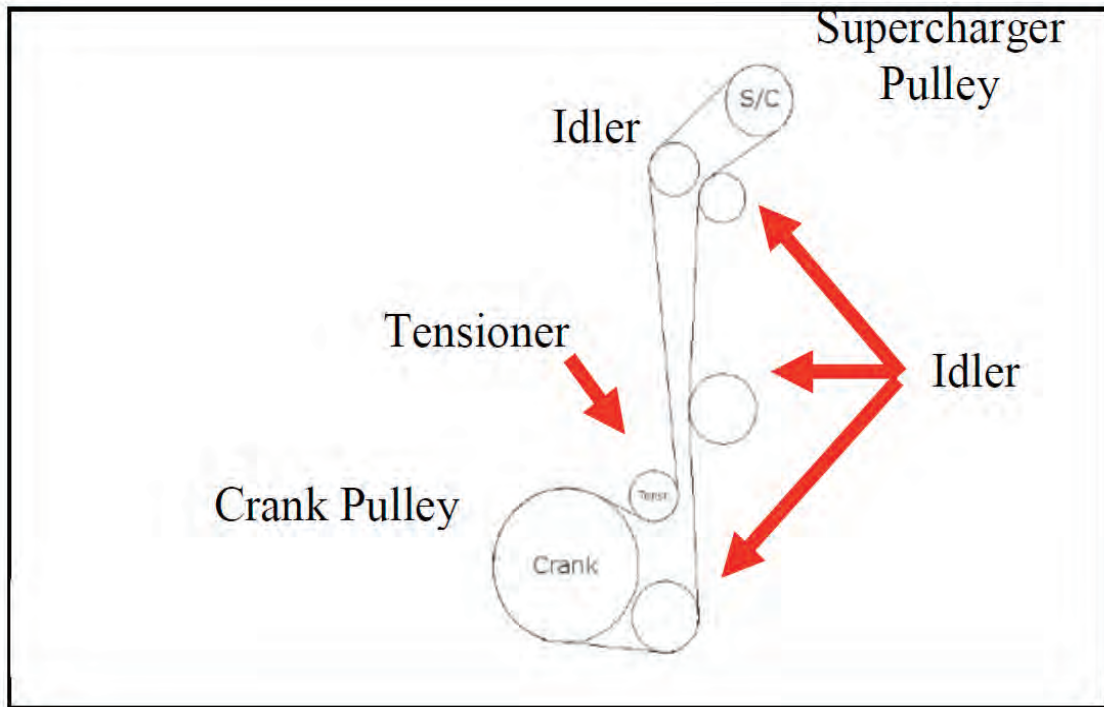

Belt Routing Diagram

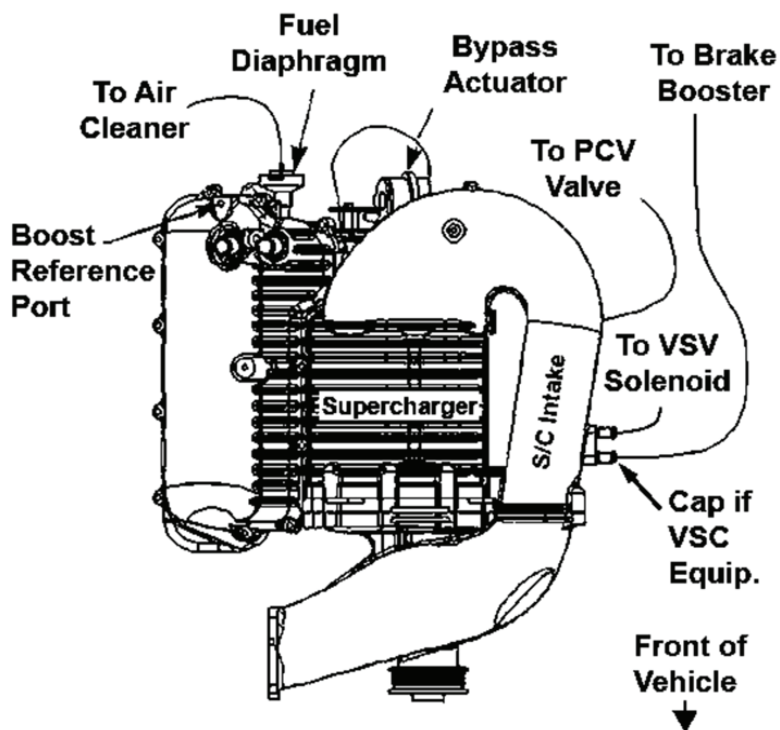

Vacuum Routing

Hood Insulation Template

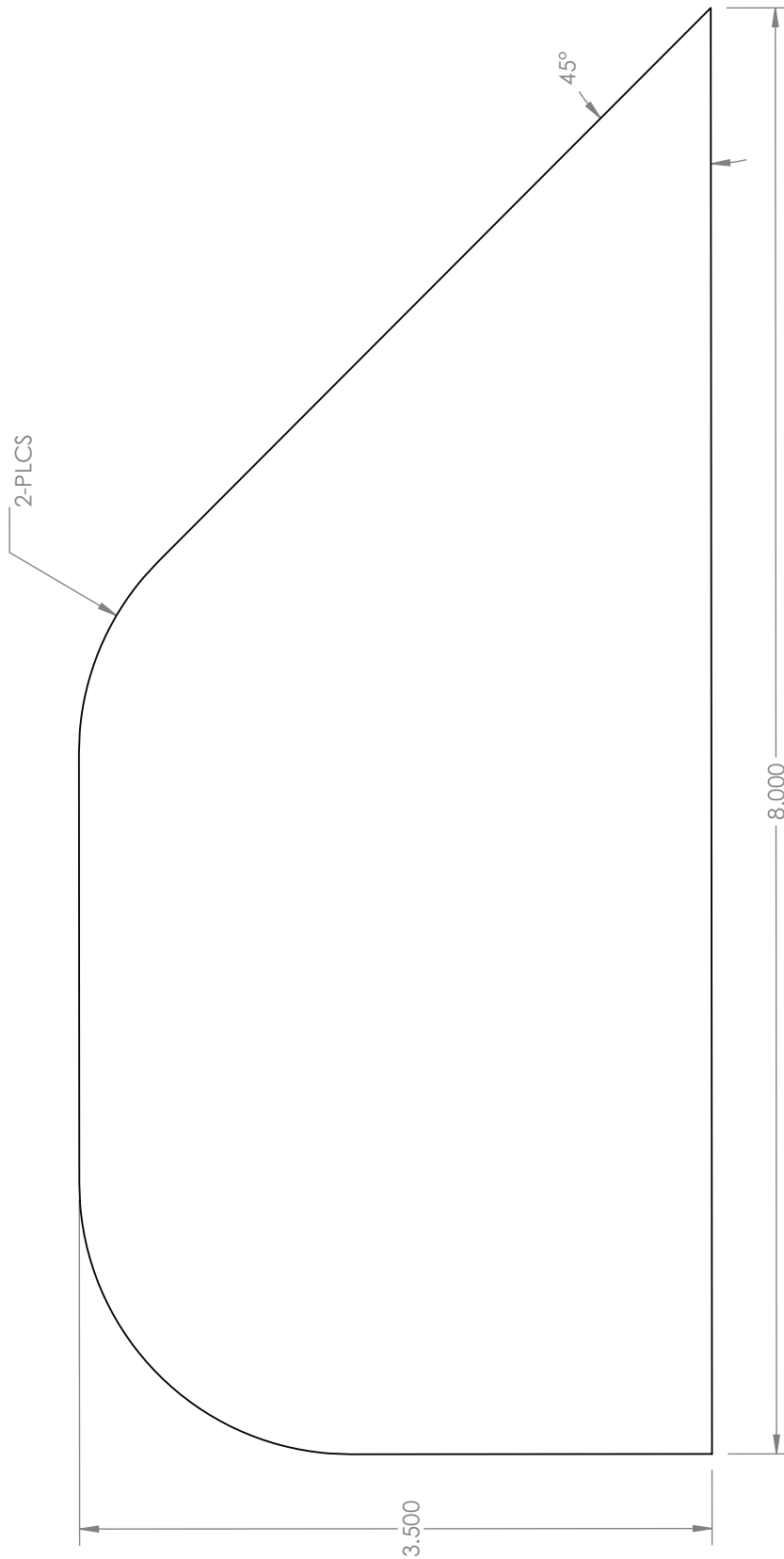

Notes

Notes

Notes

Notes



Use only premium gasoline fuel, 91 octane or better.

MAGNUSON
SUPERCHARGERS