

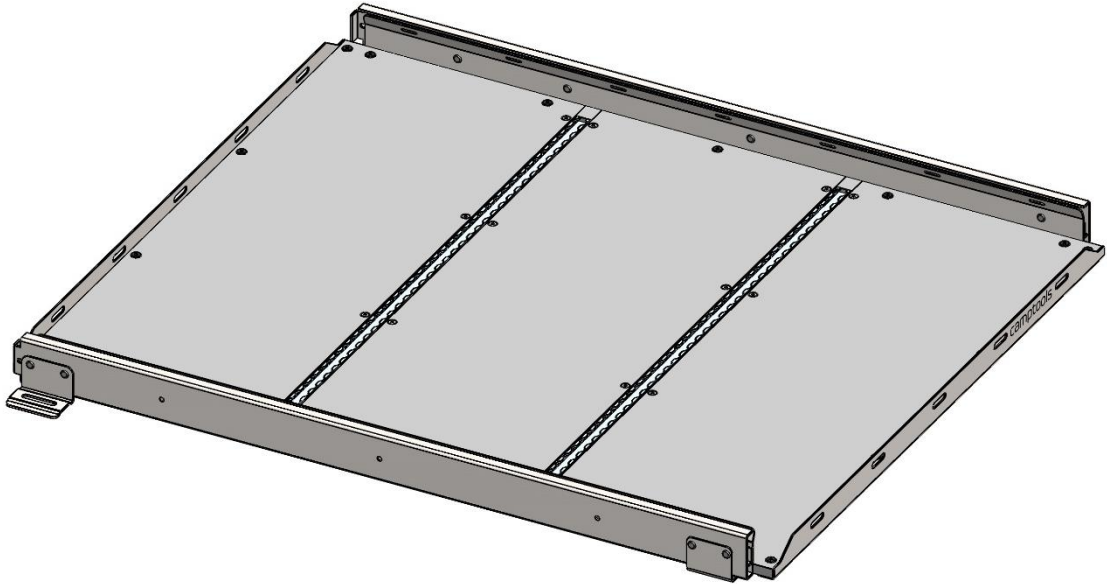

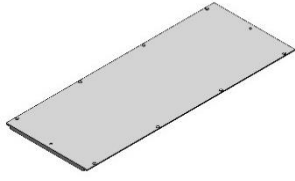

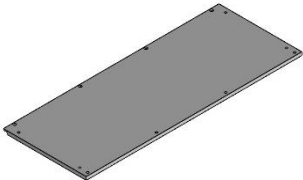

Montageanleitung Heckauszug 1250 4fix

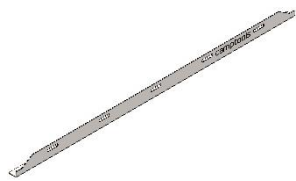
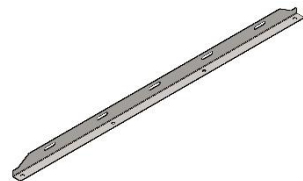
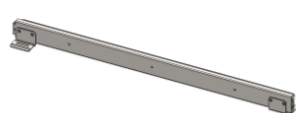

Lieferumfang

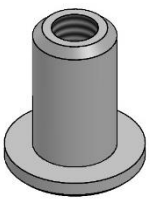
Menge / Bezeichnung	Bauteil
- 1 Stück Grundplatte 930 x 406mm	
- 2 Stück Grundplatte 930 x 400mm	
- 2 Stück Airlineschiene 930mm	
- 1 Stück Frontblech (mit Logo) - 1 Stück Rückblech	 
- 1 Stück Schwerlastauszug vormontiert links - 1 Stück Schwerlastauszug vormontiert rechts	 
- 18 Stück Flachkopschraube M6x15 - 18 Stück Rundmutter M6x15	 
- 16 Stück Senkschraube ISO10642 M6x10	
- 4 Stück Füllstück (NUR BEI VOLKSWAGEN)	

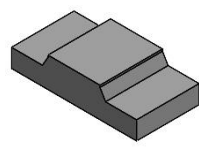
Montageschritt 1 – Front-/Rückbleche an den Grundplatten 1040x400mm montieren

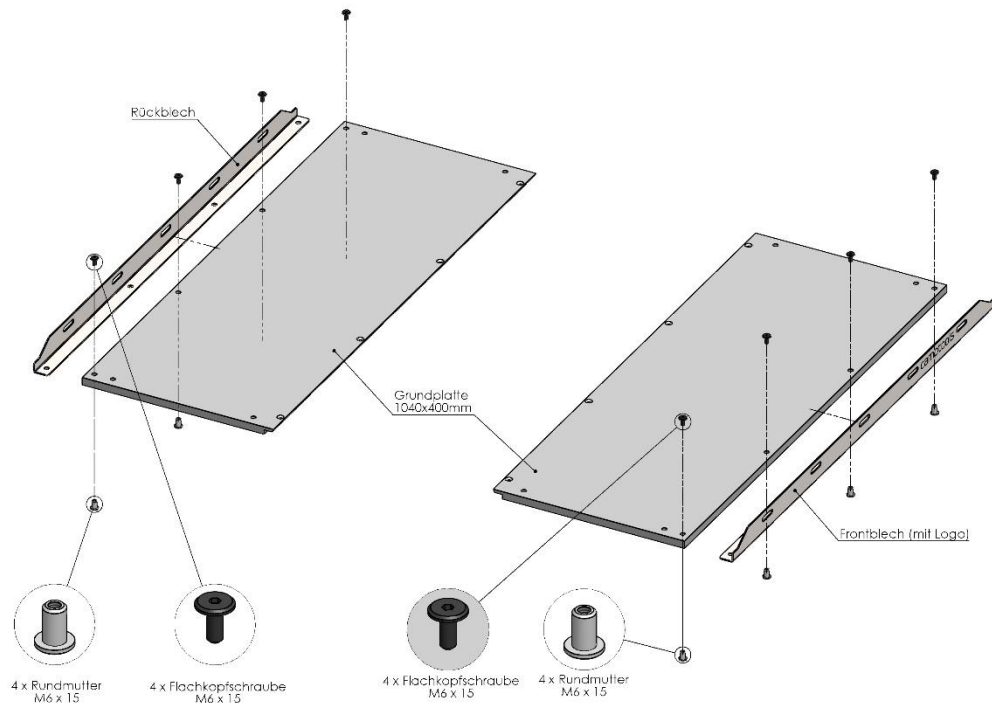

Montageschritt 2 – Airline Schienen und Grundplatten montieren

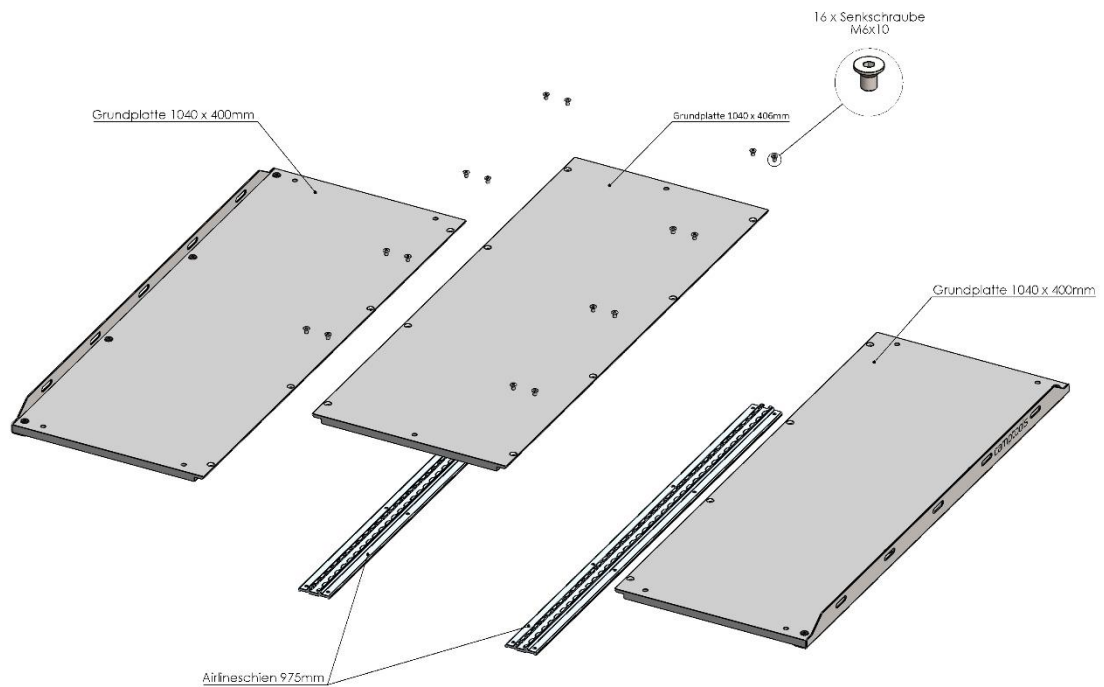

Montageschritt 3 – Schwerlastauszüge links/rechts montieren

