

IMPORTANT INFORMATION

SAFETY & RESPONSIBILITY

The operator of any tools should be skilled and familiar with the correct use of each tool. Proper safety gear must always be worn. It is the responsibility of the installer to ensure local building code(s) are followed. If uncertain, they should consult a local official.

RECOMMENDED TOOLS:

Miter Saw	and/or	Circular Saw	and/or	Table Saw
Finishing Blade		Drill w/ #2 Square Drill Bits		Rubber Mallet
Measuring Tape		Pencil/Marker		Level
Caulking Gun		Construction Adhesive		2P-10 Adhesive
(Needle Nose) Pliers		Utility Knife		Fine Sandpaper
Safety Glasses		Earplugs		Dust Mask

PRODUCT COLORING:

One of the great things about LANAI Premium Plank Decking is the beautiful variation in color tones in each *Deck Plank* and between different *Deck Planks*. It is very important to open as many bundles as possible and lay the *Deck Planks* out ensure the varying colors are evenly distributed to achieve the desired look. It is also important to note that *Deck Planks* should be used only with the grain (rough) side up. The bottom edge is very smooth and shiny and could be dangerous when wet.

CUTTING:

All cuts should be done very slowly and with a finishing or diamond. blade. The number of teeth will depend on the size of the blade.

PRODUCTS:

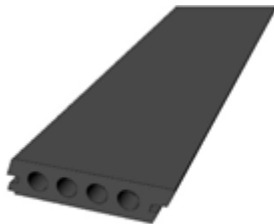

DECK PLANK
(48"x4"x1")



NARROW PLANK
(48"x2"x1")



DECK NOSING
(48"x3"x1")



HIDDEN NOSING
FASTENER

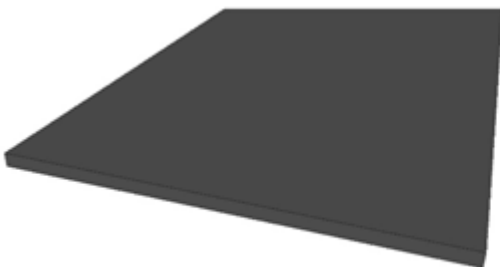

DECK FASCIA
(48"x12"x1/4")

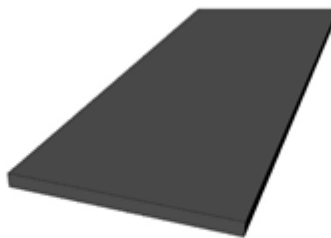

DECK RISER
(48"x7.25"x1/4")



HIDDEN PLANK
FASTENER



(FIT) FIRST-ROW
INSTALL TOOL

For more information, please visit our website or contact us:

www.LANAIoutdoors.com * Toll Free at 1-877-477-4373 * Email at hello@lanaioutdoors.com

DECK FRAMING

It is important to locate and follow standard deck framing methods that adhere to your local building codes.

LANAI Premium Plank Decking requires a doubled rim joist around the perimeter. This is needed for the installation of the *Hidden Nosing Fasteners and Deck Nosing*, which are the starting point of the deck installation. It is always recommended to frame any decking structure at a slight slope to help allow for additional drainage. As a rule, joists should be sloped 1/8" per foot away from the house. A very level joist substructure is essential. Ensure joists are very level and you may have to crown and plane some joists as needed. Refer to your local building code official for recommendations before building sub-structure.

LANAI is engineered to span joists framed 16" on center, but we highly recommend framing to 12" on center. This provides additional strengths as well as four staggered *Deck Plank* lengths creating a much nicer look. All framing should be completed with pressure-treated lumber and required fasteners. If the deck is already framed to 16", additional joists can be added for even more varied lengths. Cross-bracing should also be added every 4-6' between all joists (not below shown in all diagrams in these Installation Instructions).

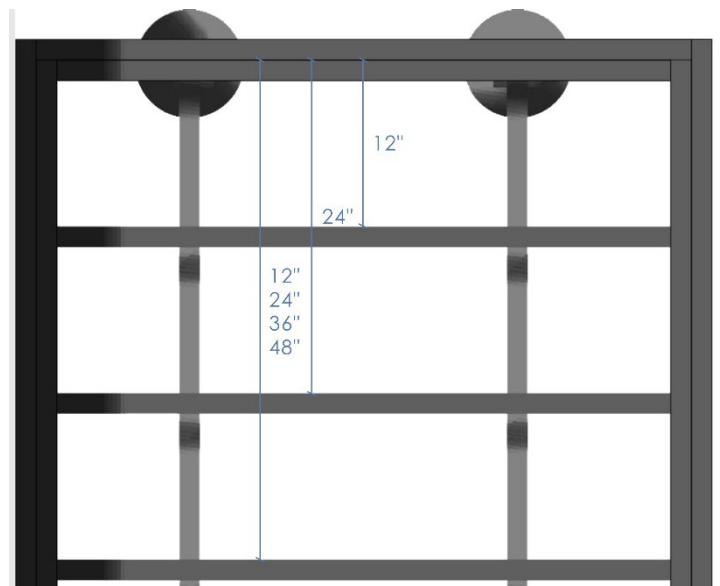
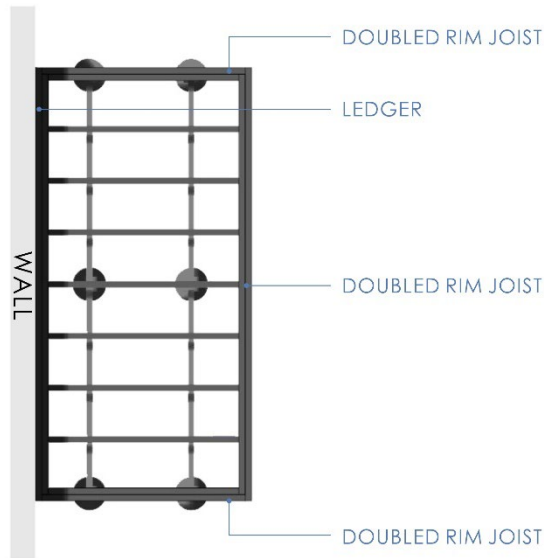

For more information, please visit our website or contact us:

www.LANAIoutdoors.com * Toll Free at 1-877-477-4373 * Email at hello@lanaioutdoors.com

BEFORE YOU START

INSTALL TEMPERATURES:

PVC decking will expand a small amount at high temperatures. It is highly recommended to either install during cooler temperatures (if possible) and/or to keep product shaded or in a cool area until it is ready to be installed. If product is installed while hot (expanded) it can later go back (contract) to its former size which can leave gaps – especially on longer runs.

NOTE:

Construction methods are always improving, and code is subject to change. Please go to lanaioutdoors.com for the most up-to-date Installation Instructions, and please ensure you are following updated code regulations.

GETTING STARTED

For the LANAI Premium Plank Decking system to be installed most effectively, we recommend starting at the **End Joist**, which is the furthest parallel point from the wall of the house/building. In most cases, the first course is always going to consist of *Deck Nosing*.

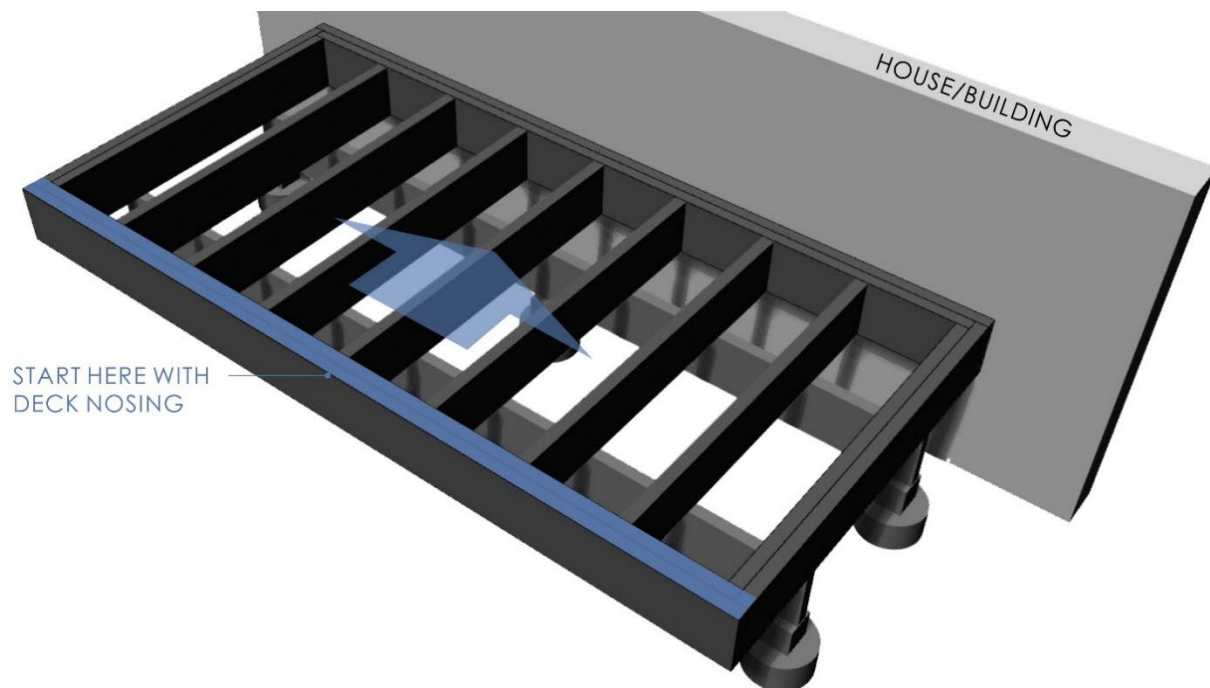

The only time the first course should be *Deck Planks* is when LANAI is being installed between two walls (as per below). In this situation *Deck Planks* would be installed from wall to wall, or a 'picture frame' install can be done using only *Deck Planks*.

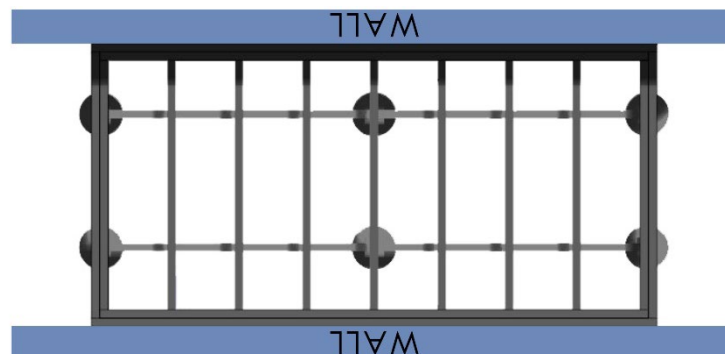

For more information, please visit our website or contact us:

www.LANAIoutdoors.com * Toll Free at 1-877-477-4373 * Email at hello@lanaioutdoors.com

PRO TIP These installation instructions recommend starting your install with smaller pieces of Deck Nosing at the corners, as the smaller the piece the less likely it is for the miter seam to 'open up' or have a gap. We recommend cutting the miter close to the middle of a Deck Nosing, creating a 23" and a 25" corner piece.

It is best to cut the first *Deck Nosing* BEFORE you begin installing *Deck Nosing Fasteners* as you will want to use the *Deck Nosing* as a guide to make sure everything is in the right place. Using a saw with a fine-tooth or diamond blade, begin by cutting a *Deck Nosing* to 23" and 25" lengths as per below. Then miter (at a 45-degree angle) the two *Deck Nosings* and ensure they fit cleanly together.

25"



23"

PRO TIP Cut slowly and straight down with the grain-side up and rounded edge of the Deck Nosing facing you to avoid any cap chipping. Cutting slowly and straight down with the grain-side up is also recommended for all other LANAI products.

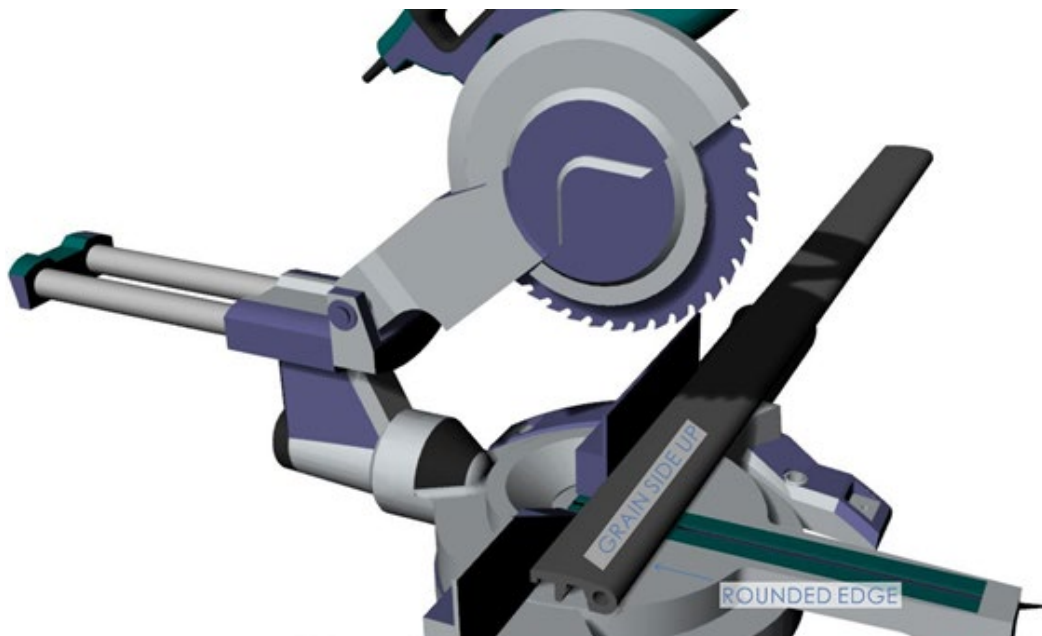

For more information, please visit our website or contact us:

www.LANAIoutdoors.com * Toll Free at 1-877-477-4373 * Email at hello@lanaioutdoors.com

INSTALLING THE PERIMETER DECK NOSING

1. Hidden Nosing Fastener Installation:

First attach the *Hidden Nosing Fasteners* along the **Outer End Joist**. The etched line on the *Hidden Nosing Fastener* should be in-line with the line between the two **End Joists**.

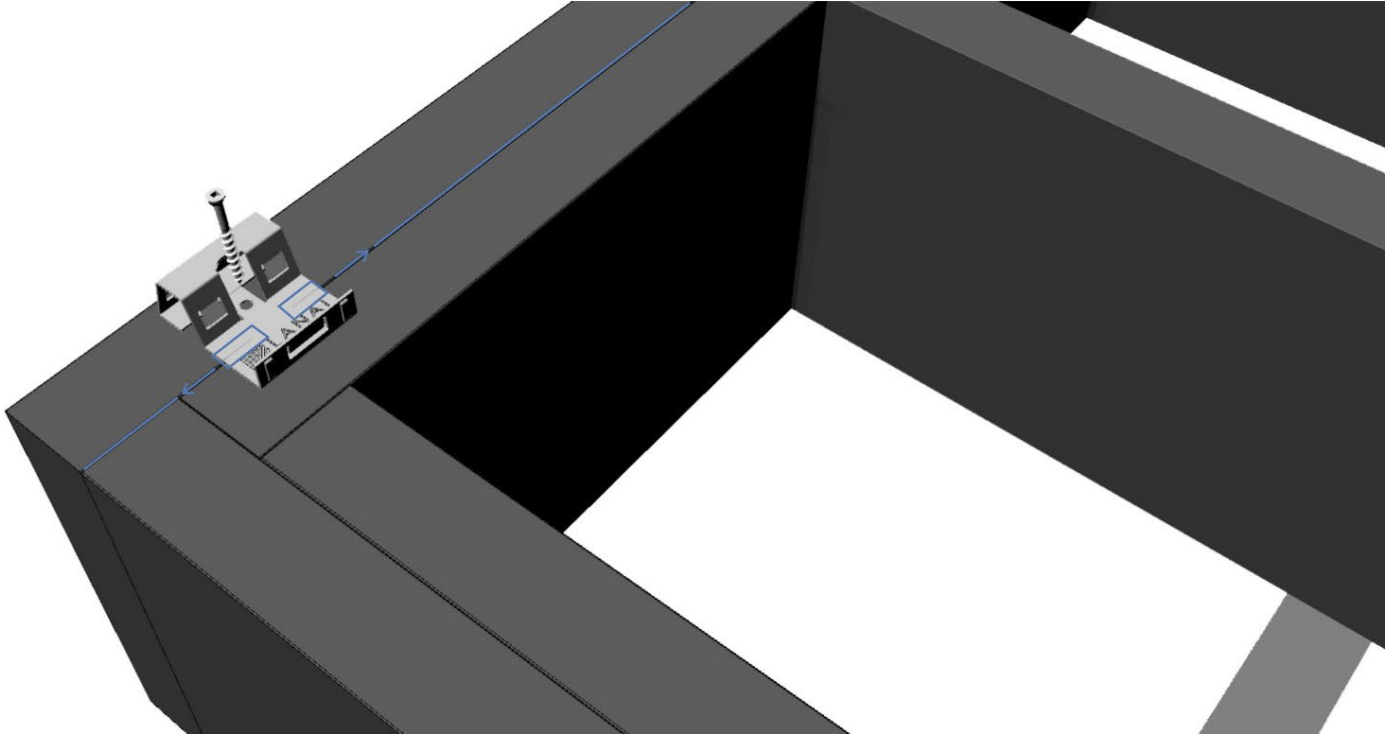

Begin by installing the first *Hidden Nosing Fastener* approximately 2¼" from the outer edge of the **Outer Side Joist**.

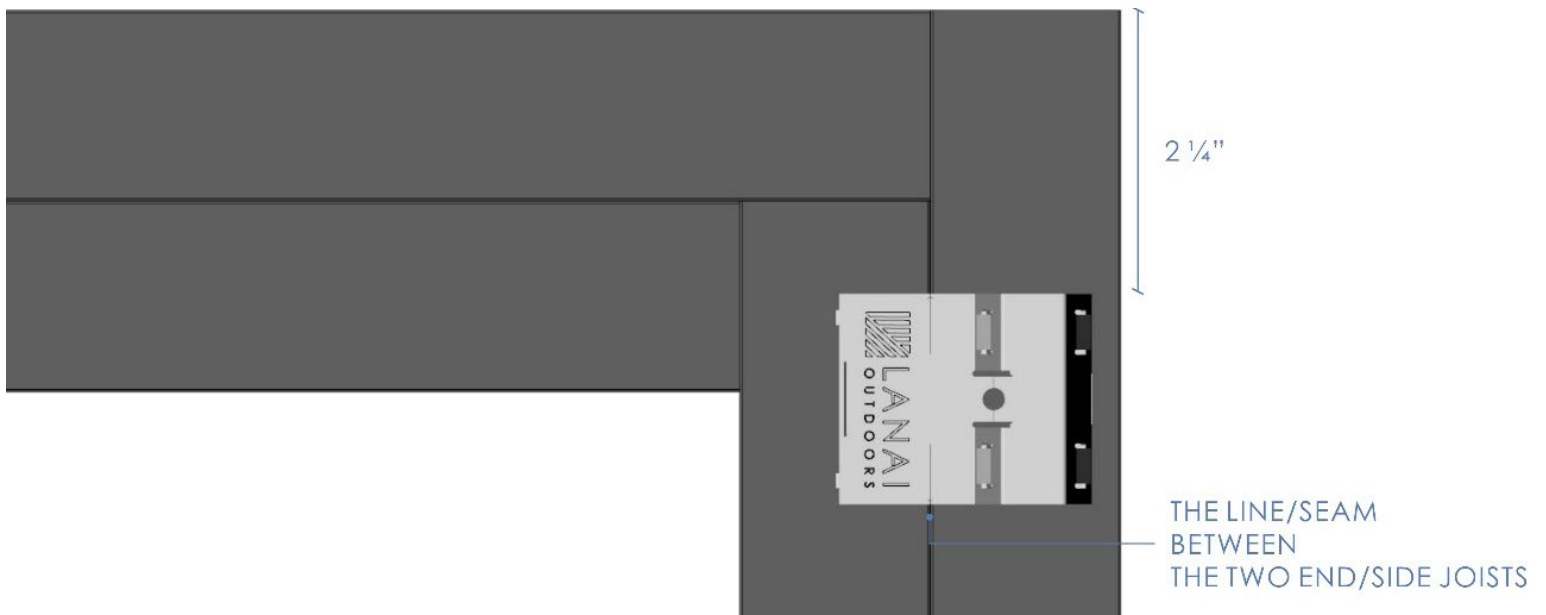

For more information, please visit our website or contact us:

www.LANAIoutdoors.com * Toll Free at 1-877-477-4373 * Email at hello@lanaioutdoors.com

Place the second *Hidden Nosing Fasteners* 8" from the first one, and then another one at the end of that cut *Deck Nosing* (another 8").

PRO TIP You can never have too many Nosing Fasteners, so you can double or triple the number used for high-traffic areas.

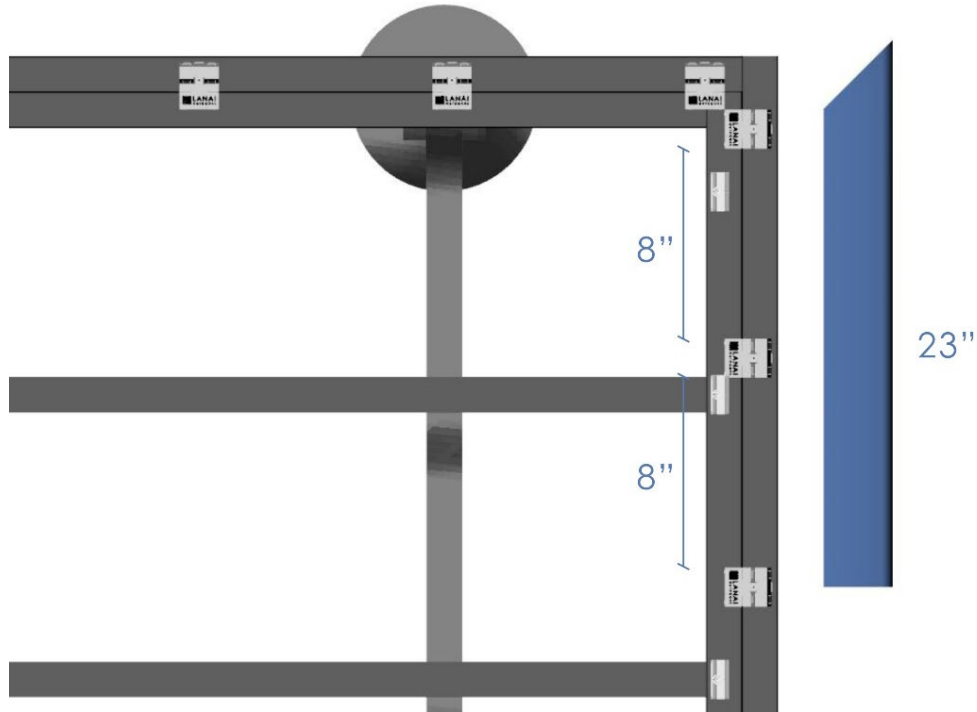

If the *Hidden Nosing Fastener* and the *Hidden Plank Fastener* hit one another, move the *Hidden Plank Fasteners* over to adjust.

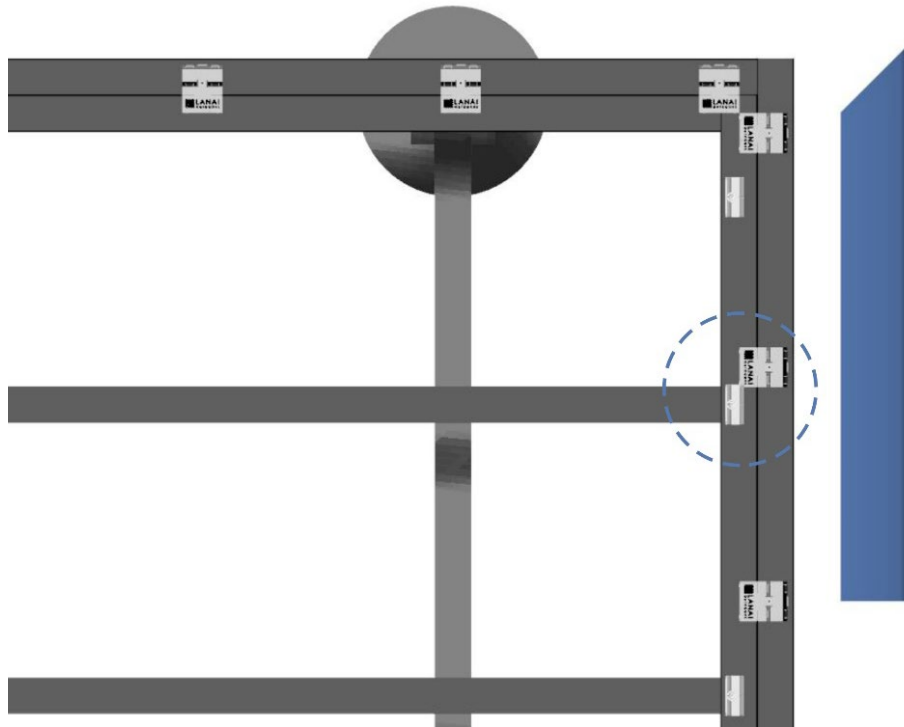

For more information, please visit our website or contact us:

www.LANAIoutdoors.com * Toll Free at 1-877-477-4373 * Email at hello@lanaioutdoors.com

The *Hidden Nosing Fastener* at the end of each *Deck Nosing* should be half under *that Deck Nosing* and half under the next, which will help keep all *Deck Nosings* aligned. Do not install any *Deck Nosings* at this point.

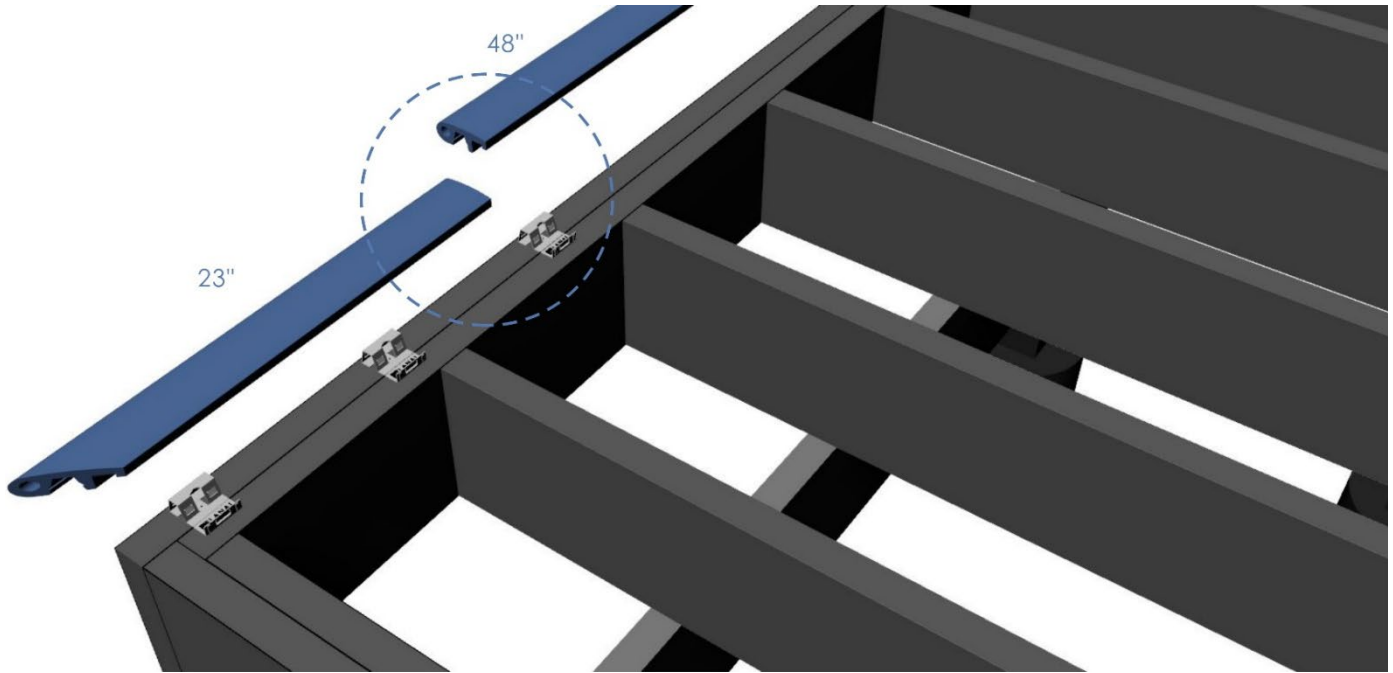

Now install *Deck Nosing Fasteners* down the adjacent *Side Joist*. The spacing between *Deck Nosing Fasteners* down the *Side Joists* will be 9" rather than 8". This is important to ensure the *Deck Nosing Fasteners* don't get in the way of the *Deck Plank Fasteners*.

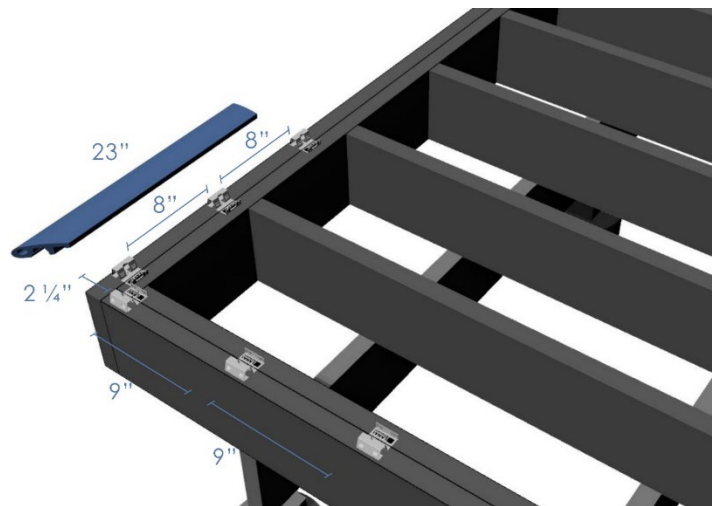
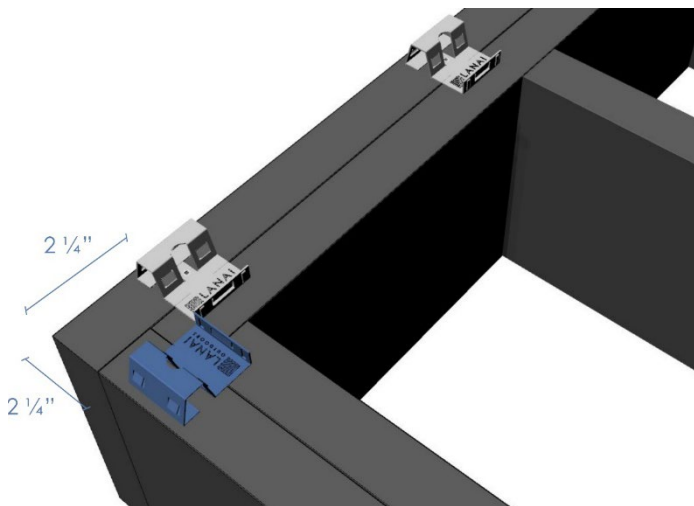

For more information, please visit our website or contact us:

www.LANAIoutdoors.com * Toll Free at 1-877-477-4373 * Email at hello@lanaioutdoors.com

Lay the two cut *Deck Nosings* in place to ensure (but do not secure) a good fit at the miter seam, proper alignment of the *Deck Nosings* and that each *Deck Nosing* covers approximately half of the *Hidden Nosing Fasteners* in both directions. Do not install yet.

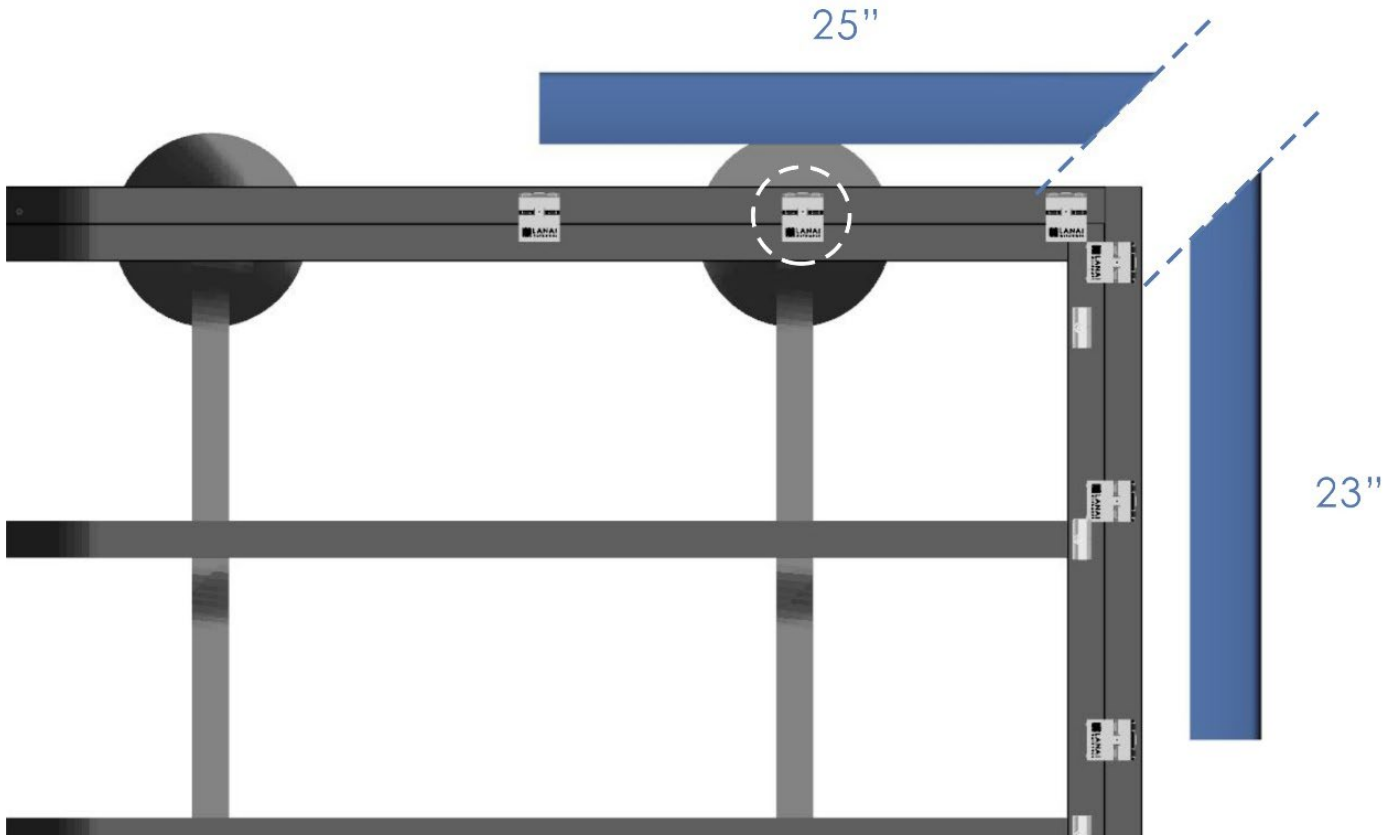

2. Hidden Plank Fastener Installation:

Position the First-row Install Tool (FIT) against the inside edge of the **Inner End Joist**, directly beside the first *Hidden Nosing Fastener*.

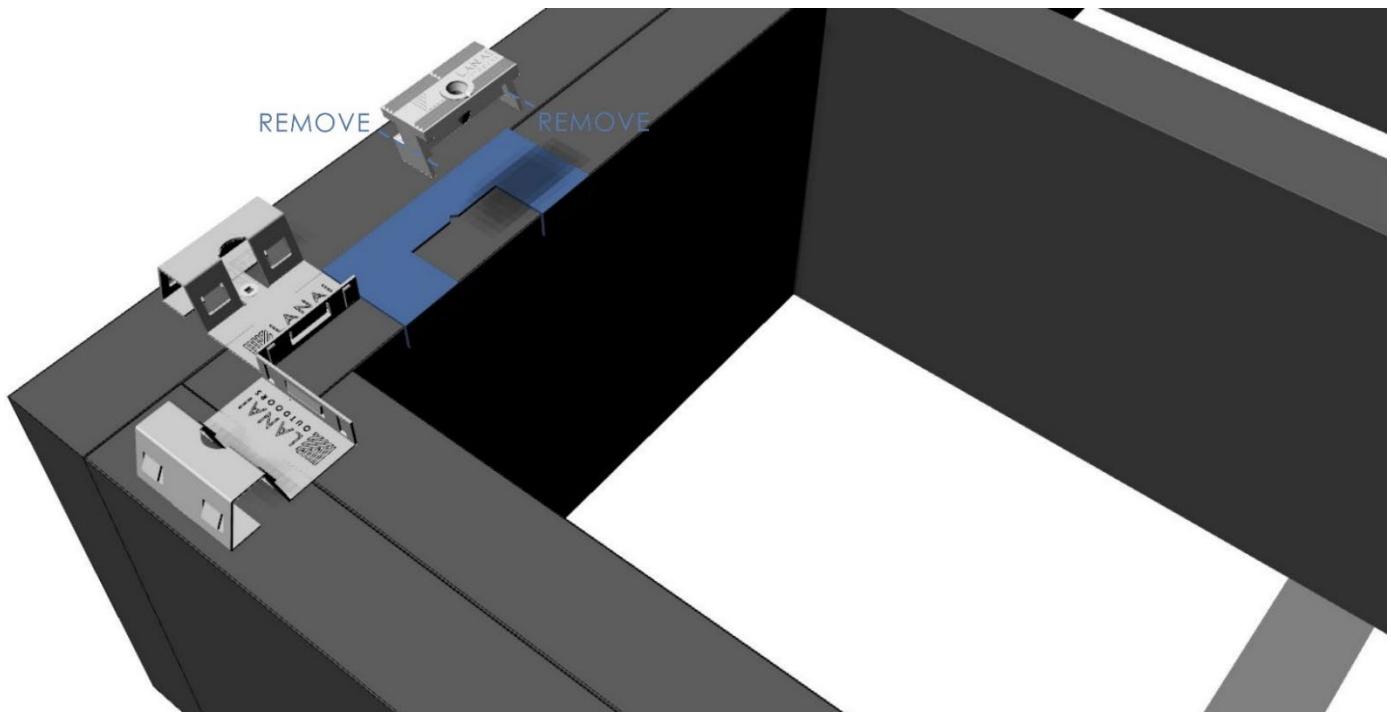

For more information, please visit our website or contact us:

www.LANAIoutdoors.com * Toll Free at 1-877-477-4373 * Email at hello@lanaioutdoors.com

PRO TIP Use a pair of regular pliers to easily remove the joist-wings. Simply bend the wings sideways and they will snap off cleanly.

First row only - both joist-wings on the *Hidden Plank Fasteners* will need to be removed.

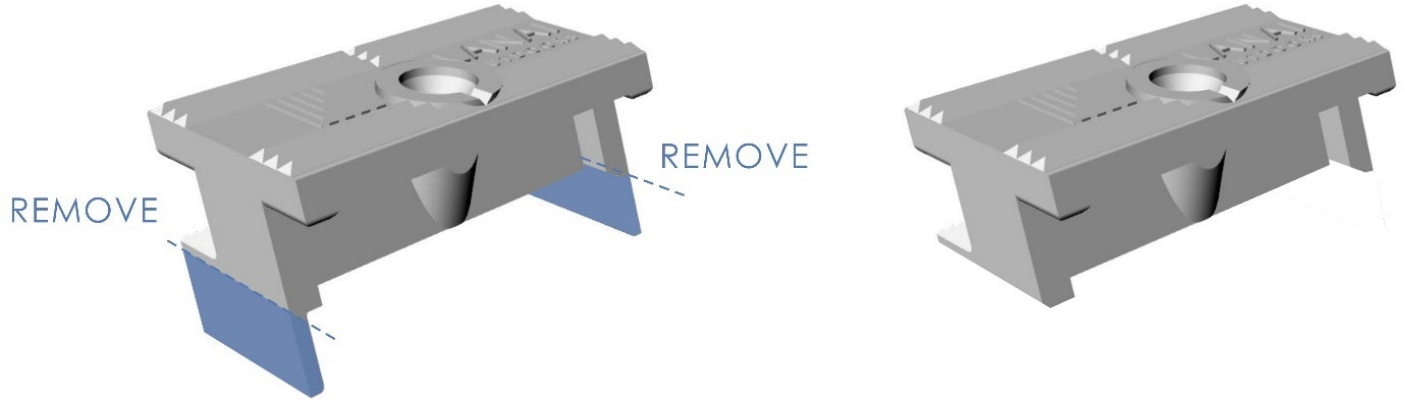

Place *Hidden Plank Fastener* into the FIT, making sure it is facing in the correct direction (LANAI logo should be facing same direction as the *Hidden Nosing Fasteners*, as per the diagram below). Secure by driving the screw into the joist until flush with the top.

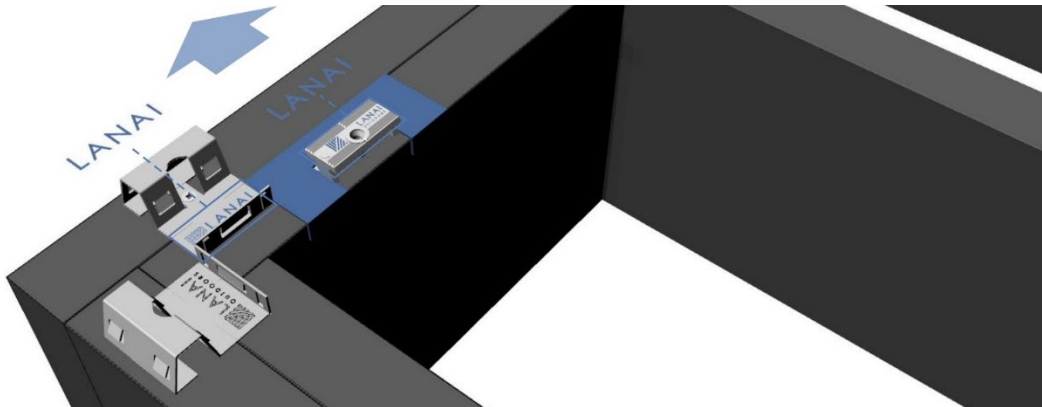

If you do not have the FIT tool, you can still measure and install the *Hidden Plank Fasteners*. Measure and mark a line $2\frac{1}{4}$ " from the outside edge of the **Outer End Joist**, or $\frac{1}{4}$ " in from the inside of the **Inner End Joist**. Install the *Hidden Plank Fasteners* with the legs touching that line(s).



For more information, please visit our website or contact us:

www.LANAIoutdoors.com * Toll Free at 1-877-477-4373 * Email at hello@lanaioutdoors.com

Next place *Hidden Plank Fasteners* centered in line with every joist that hits perpendicular to the **Inner Joist**. If a *Hidden Nosing Fastener* is in the way, the *Hidden Plank Fastener* can be placed next to it.

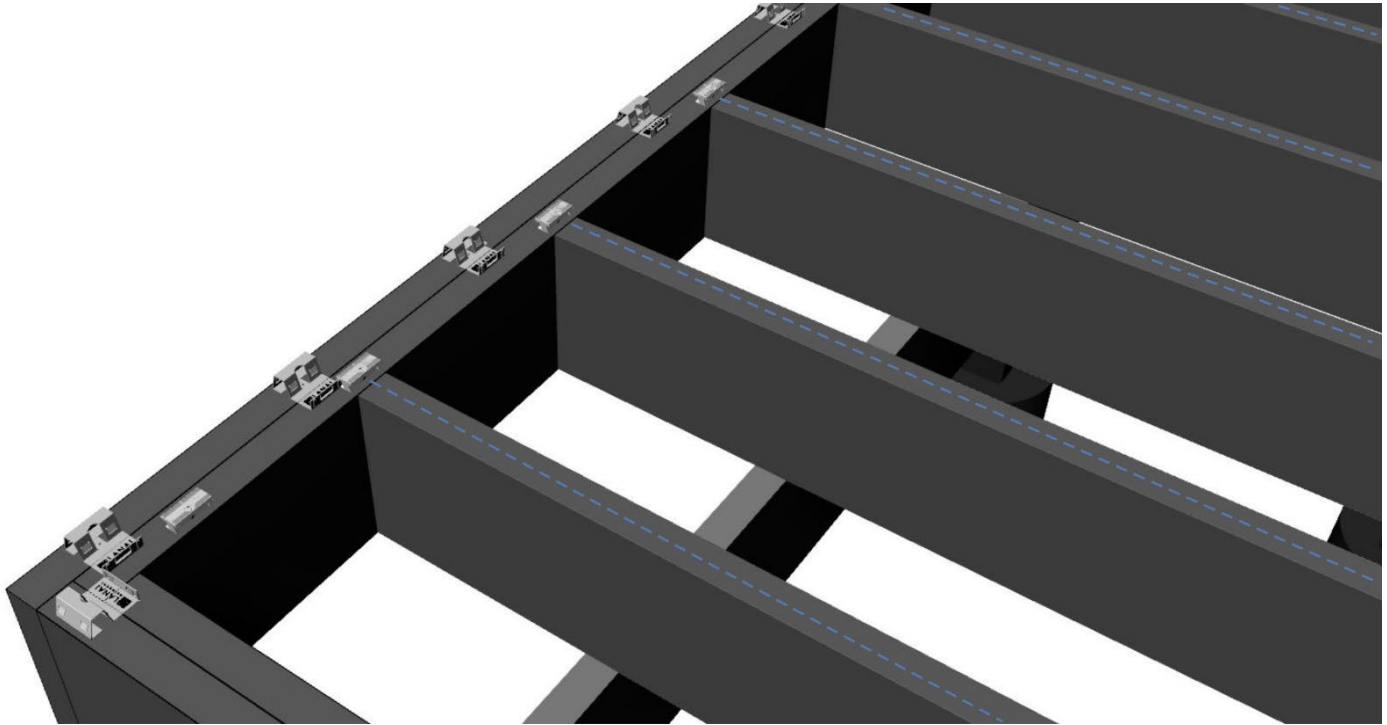

Hidden Nosing Fastener Installation:
Place the two cut *Deck Nosings* into place.

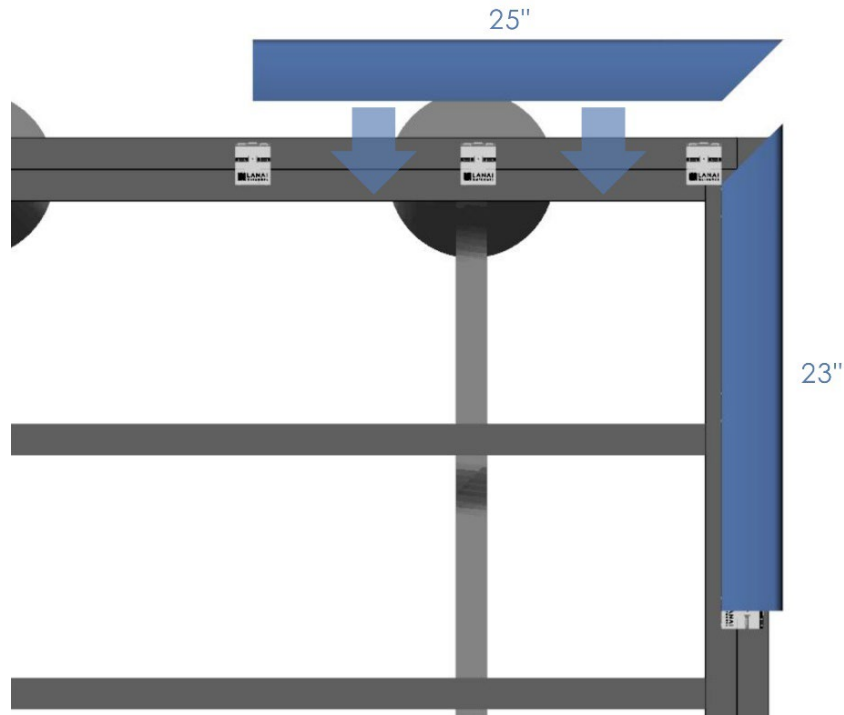

Ensure the bridge of the *Nosing Plank Fasteners* is directly under the matching bridge in the *Deck Nosings*.

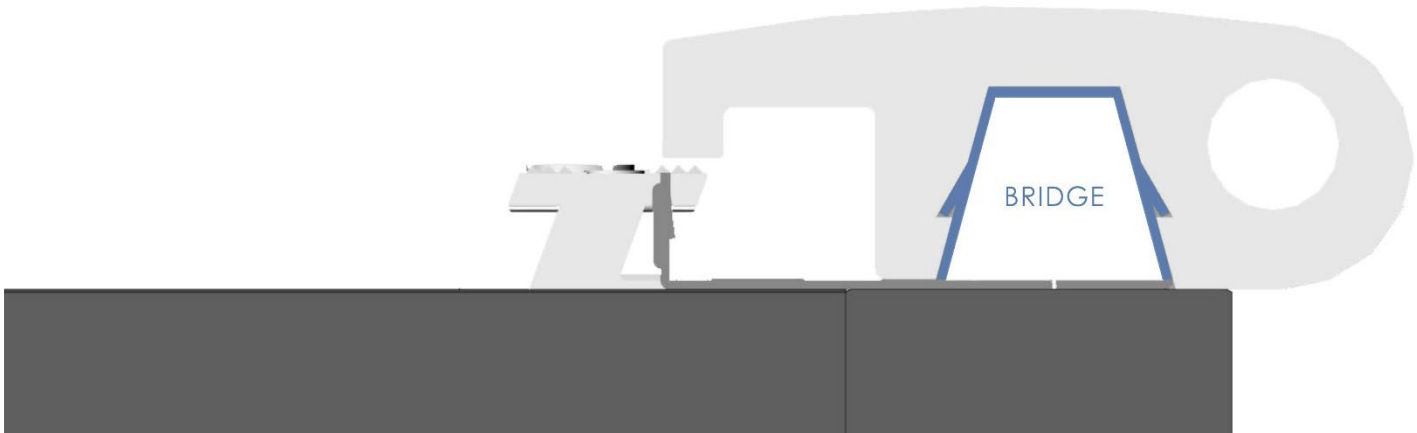

Once it is properly aligned, lightly tap down into place using a rubber mallet. You should hear a 'snap' or 'click' when it is fastened.

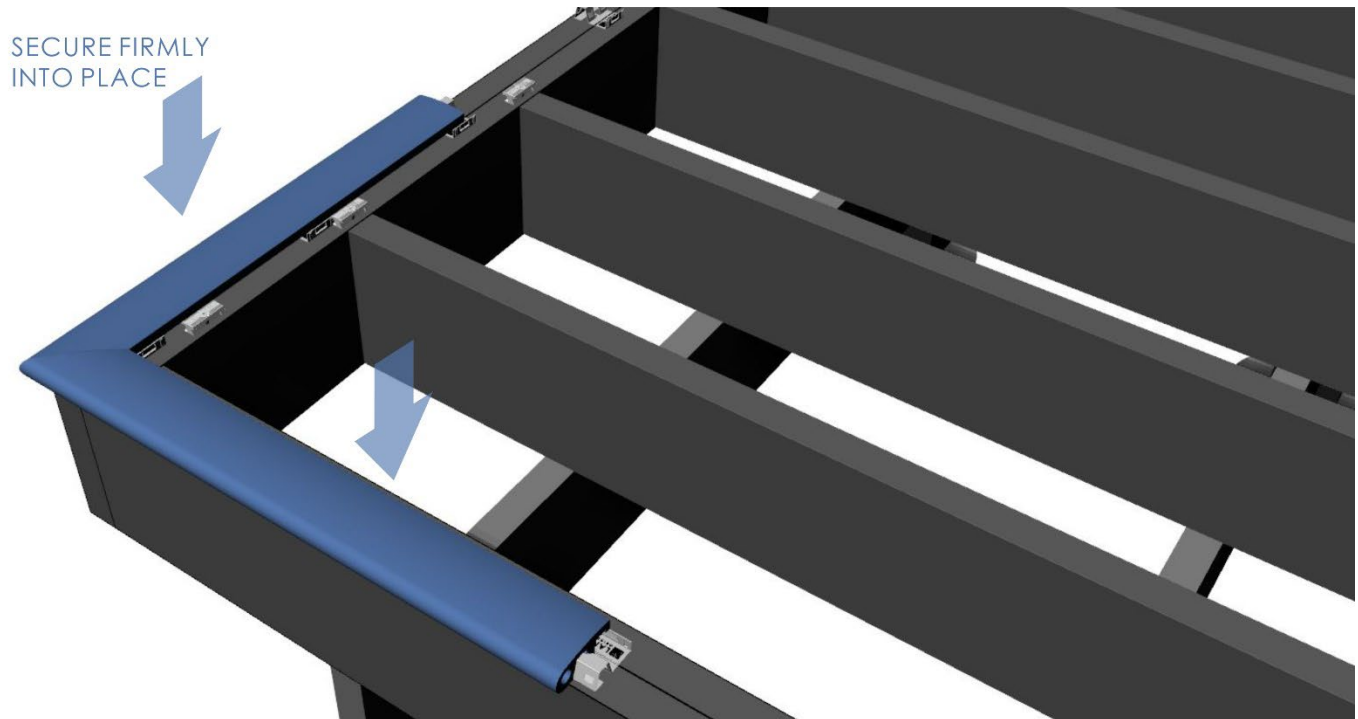

PRO TIP The rubber mallet can also be used to gently adjust the lateral placement of the Deck Nosing if necessary.

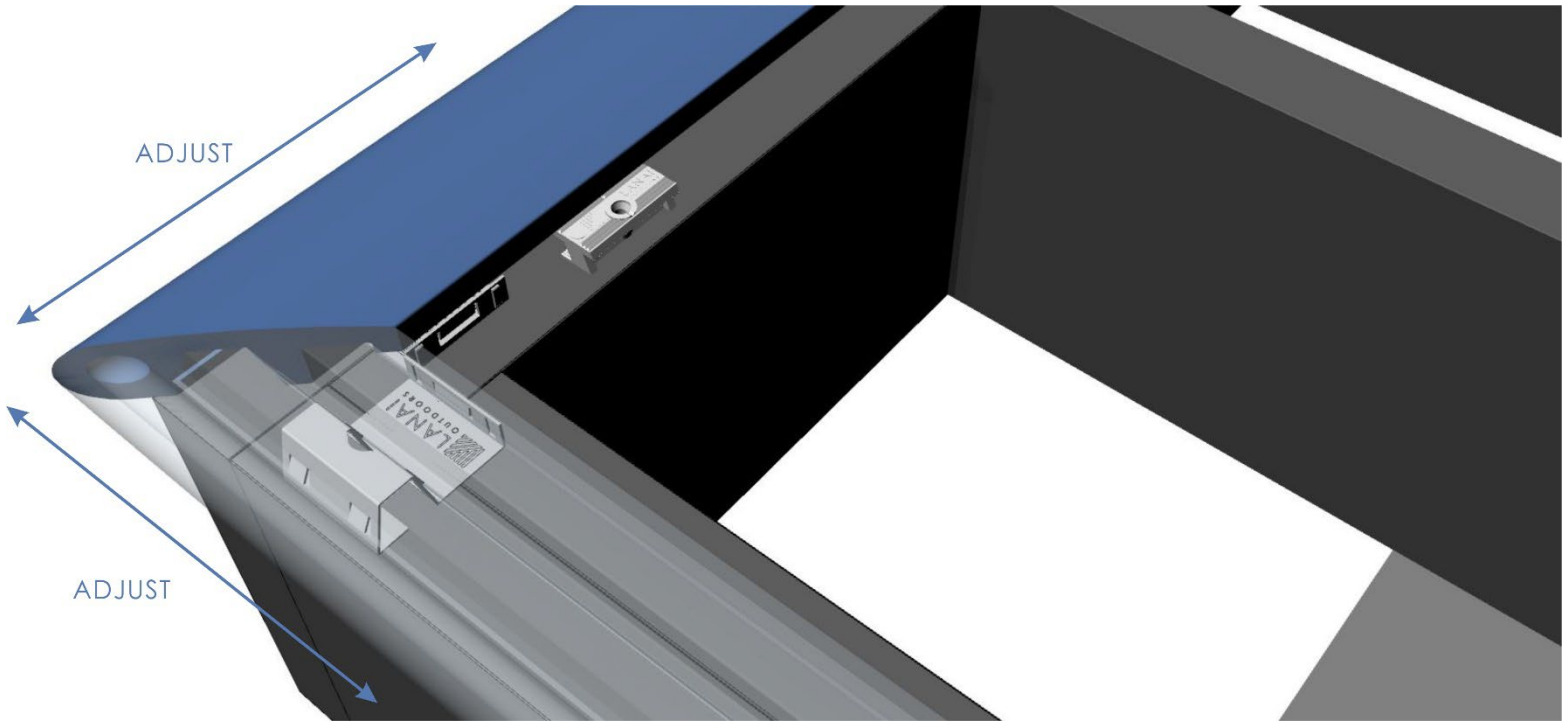

Continue installing *Deck Nosings* down the entire first row, butting them tight together. You should have a *Hidden Nosing Fastener* bridging each end, as well as two additional ones evenly spaced out.

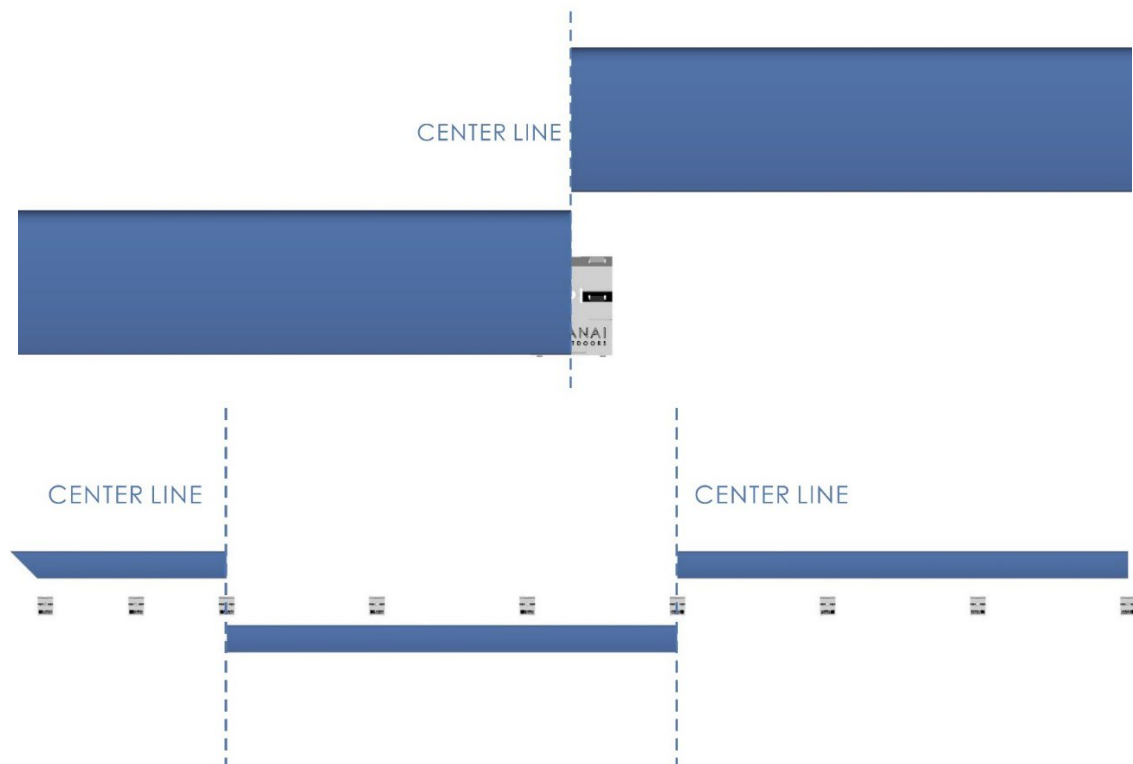

For more information, please visit our website or contact us:

www.LANAIoutdoors.com * Toll Free at 1-877-477-4373 * Email at hello@lanaioutdoors.com

Continue until there is less than 48" from outside edge of the Outer Side Joist.

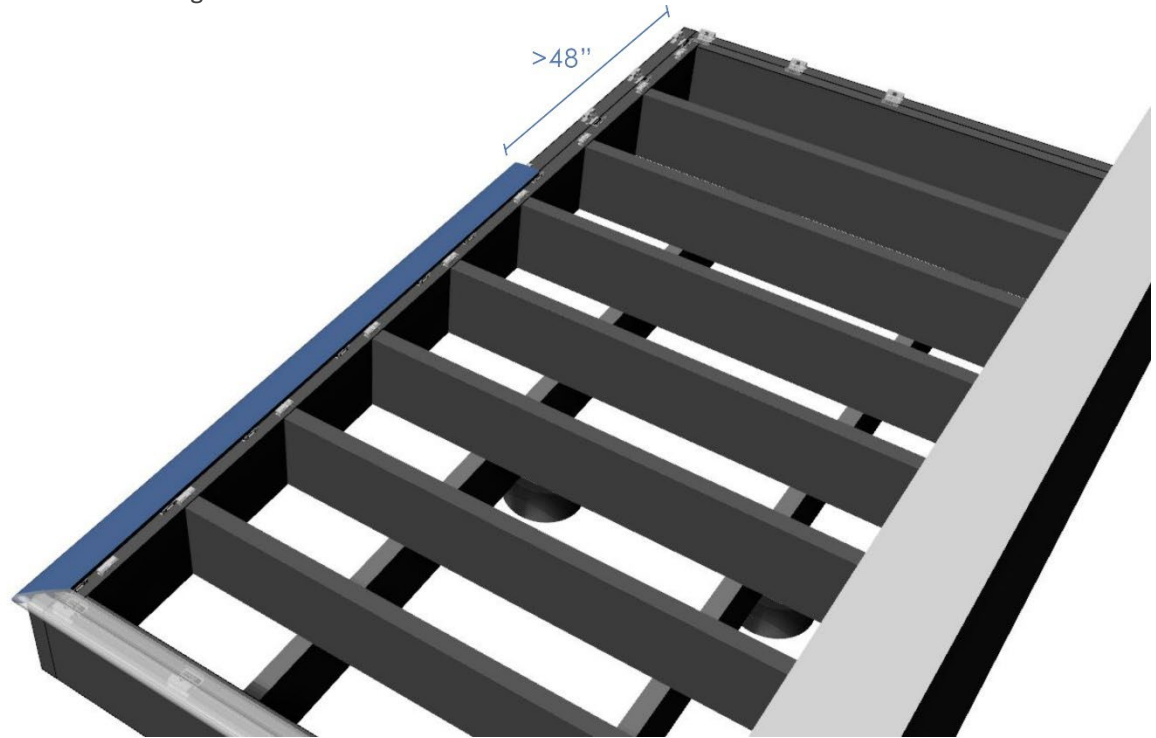

Measure and cut the final *Deck Nosing* to finish that row. You will measure to the outside of the **Outer Side Joist** and add $\frac{3}{4}$ " to that measurement. then make sure and make sure to miter out so the piece extends beyond the corner.

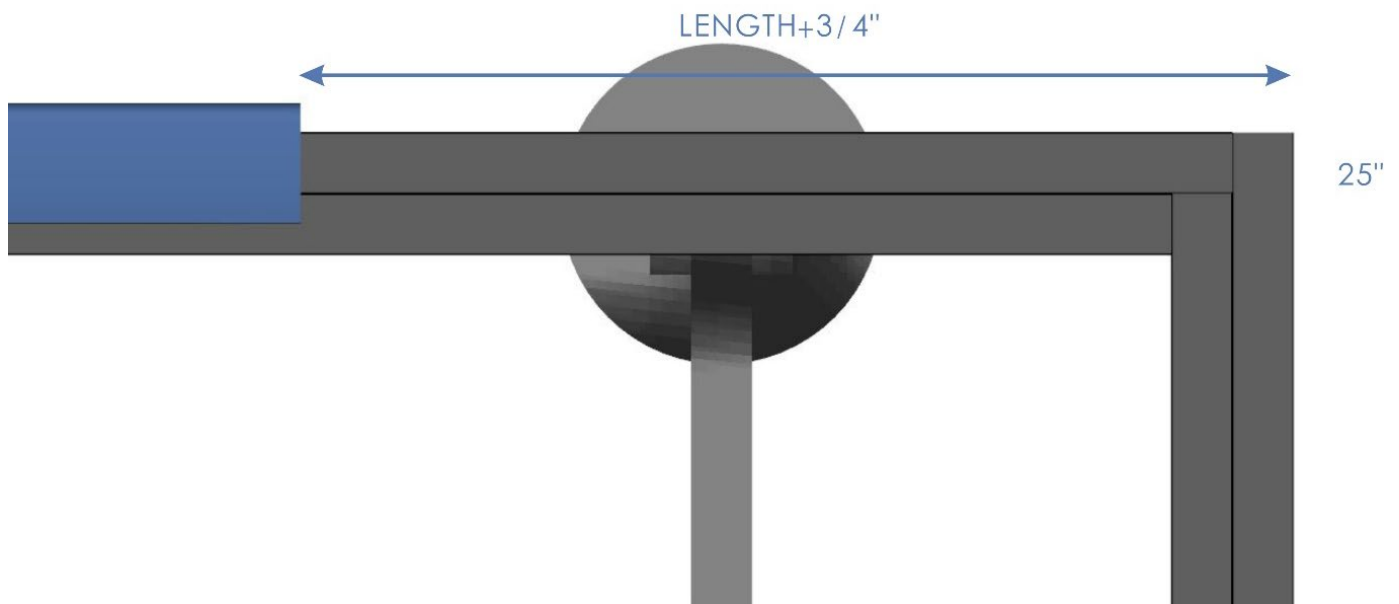

For more information, please visit our website or contact us:

www.LANAIoutdoors.com * Toll Free at 1-877-477-4373 * Email at hello@lanaioutdoors.com

Then make the necessary miter cut, but do not install the *Deck Nosing* yet.

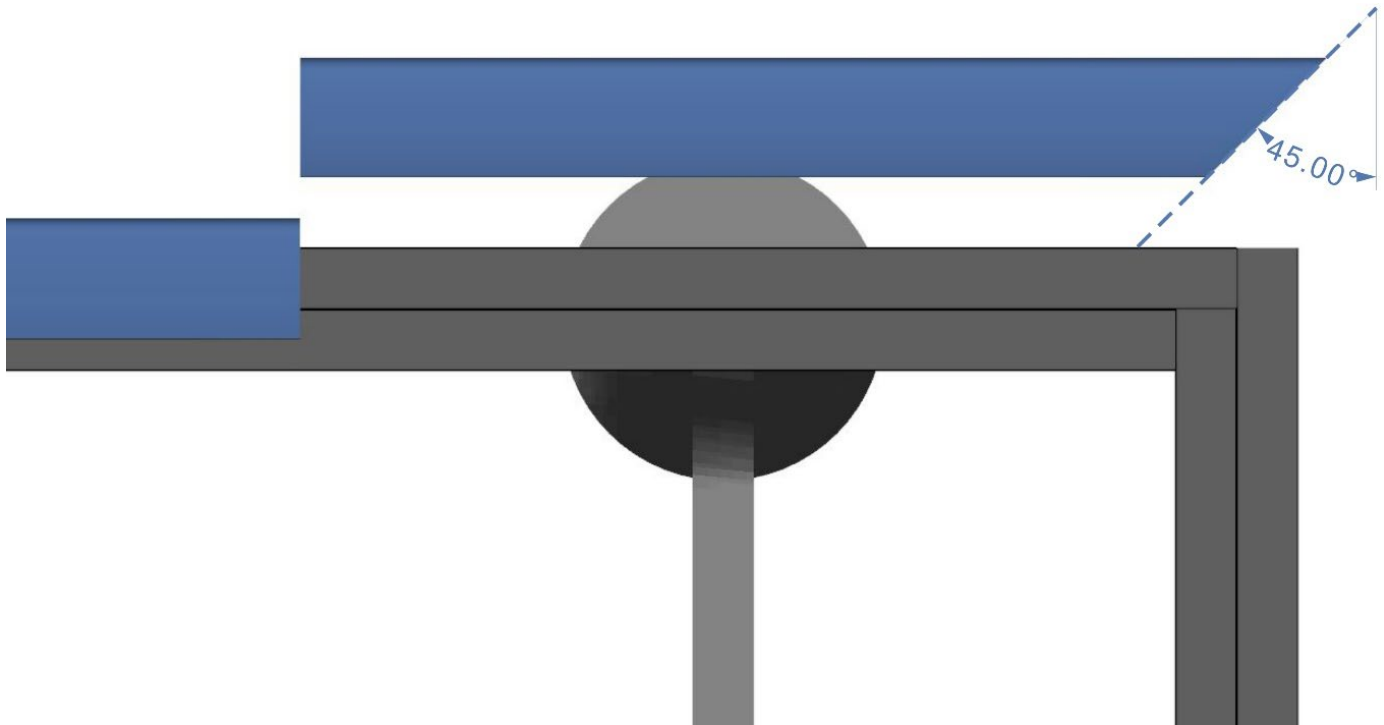

Install the adjacent *Hidden Nosing Fasteners* to match the opposite side of the deck.

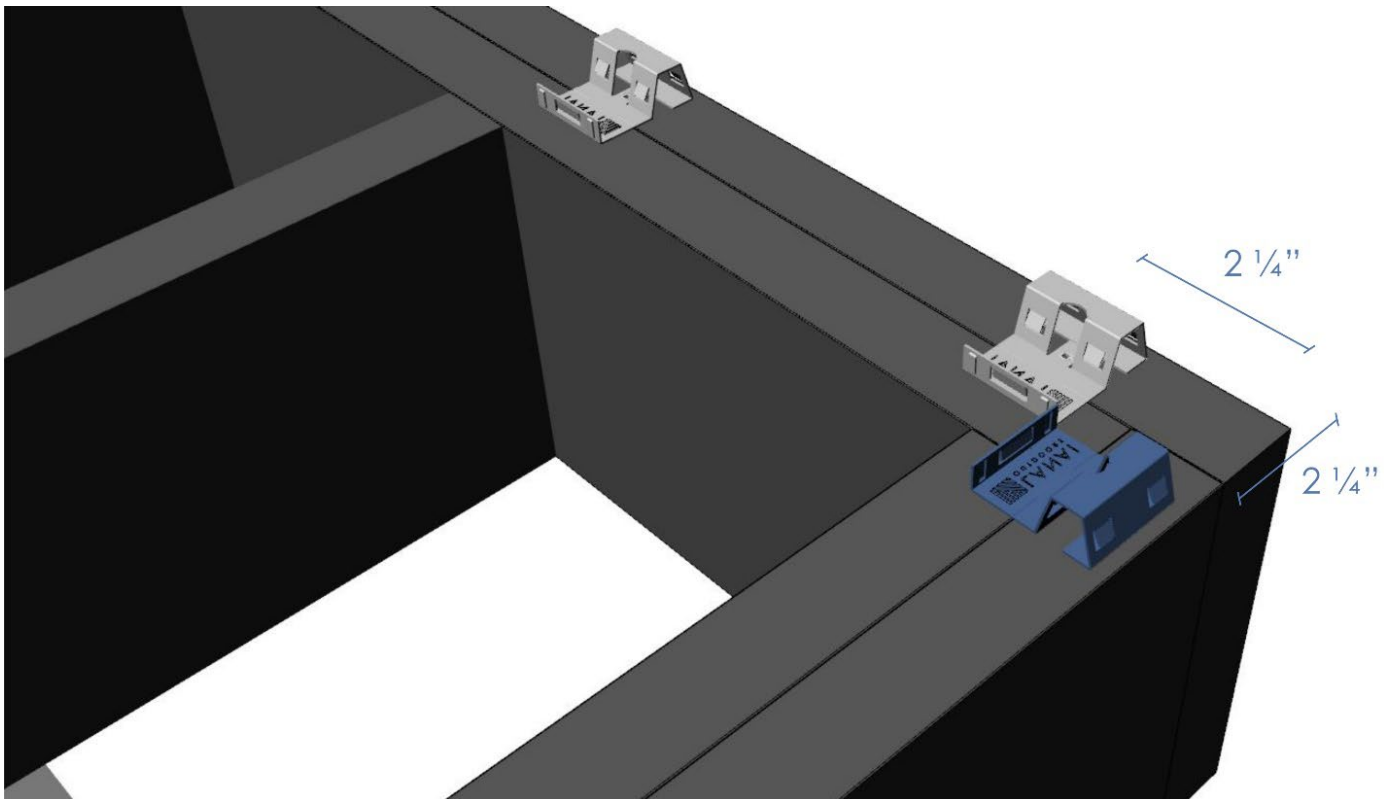

For more information, please visit our website or contact us:

www.LANAIoutdoors.com * Toll Free at 1-877-477-4373 * Email at hello@lanaioutdoors.com

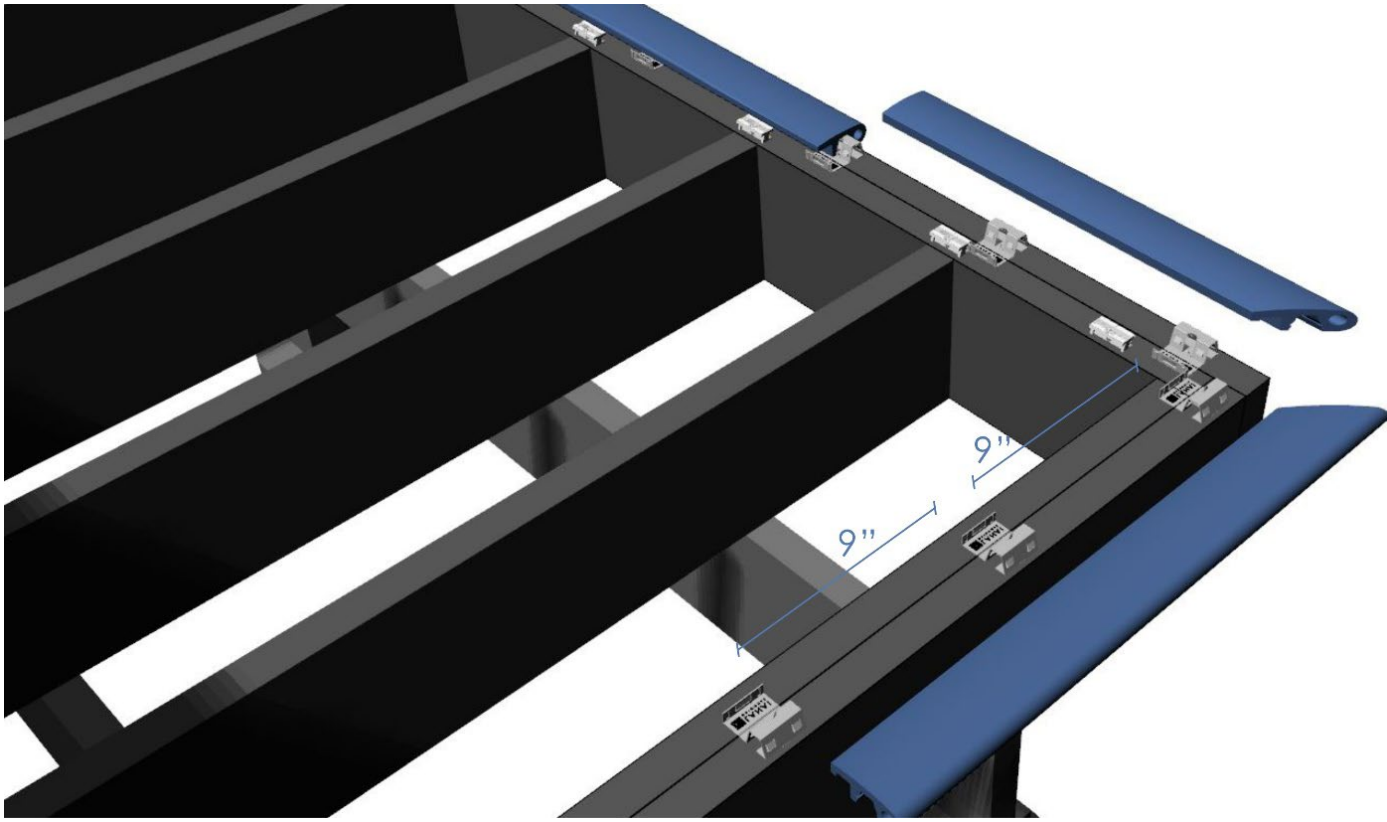

If it is long enough, cut the remainder of your last cut piece to 25". If it is not, we recommend cutting a new *Deck Nosing* to 25" to match the other side and ensure proper alignment with *Hidden Plank Fasteners*.

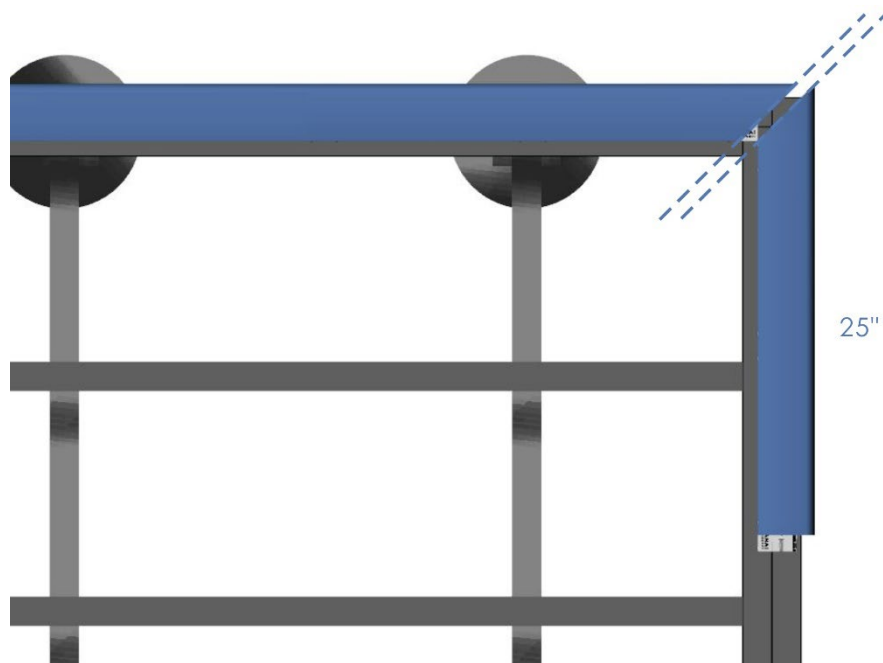

Lay Deck Nosing over the Hidden Nosing Fasteners to ensure a good fit, and then tap into place ensuring you hear the 'click' or 'snap'.

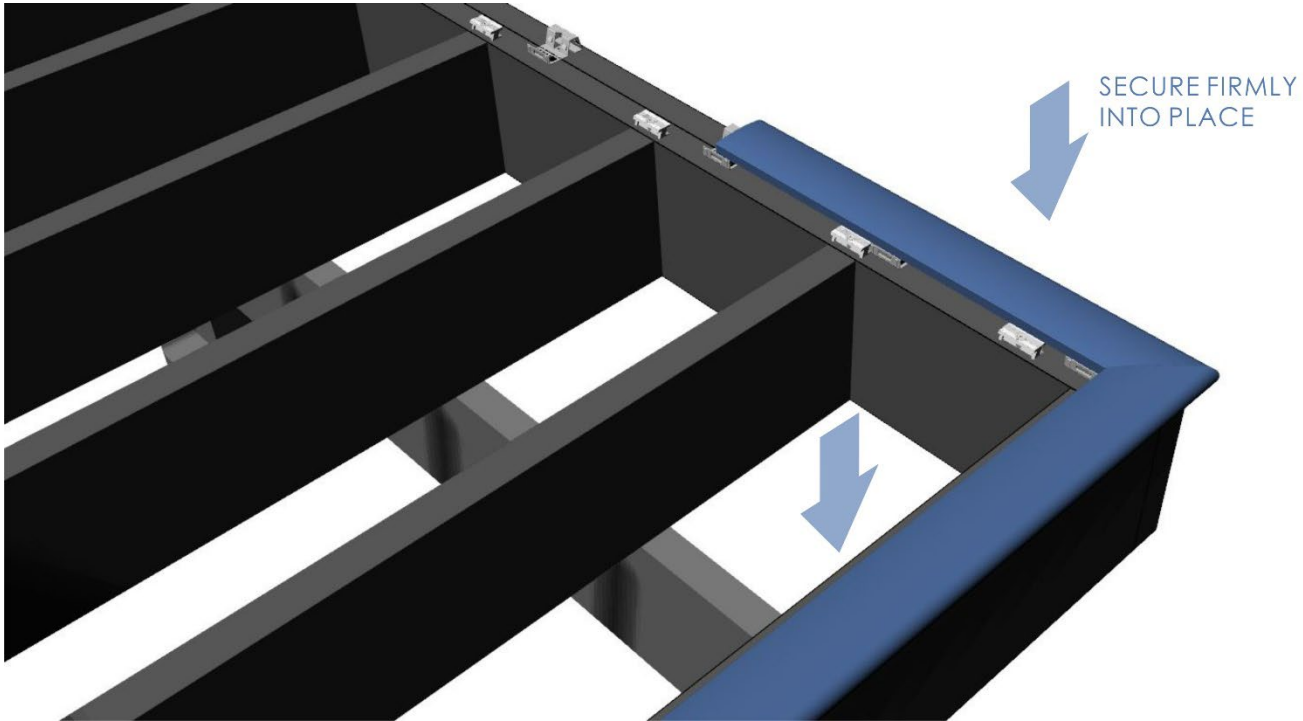

PRO TIP Adhesive can be applied to the core of the two adjoining Deck Nosings prior to installing them together. We recommend a specific adhesive for miters (Miter Pro, Mitre Bond, etc).

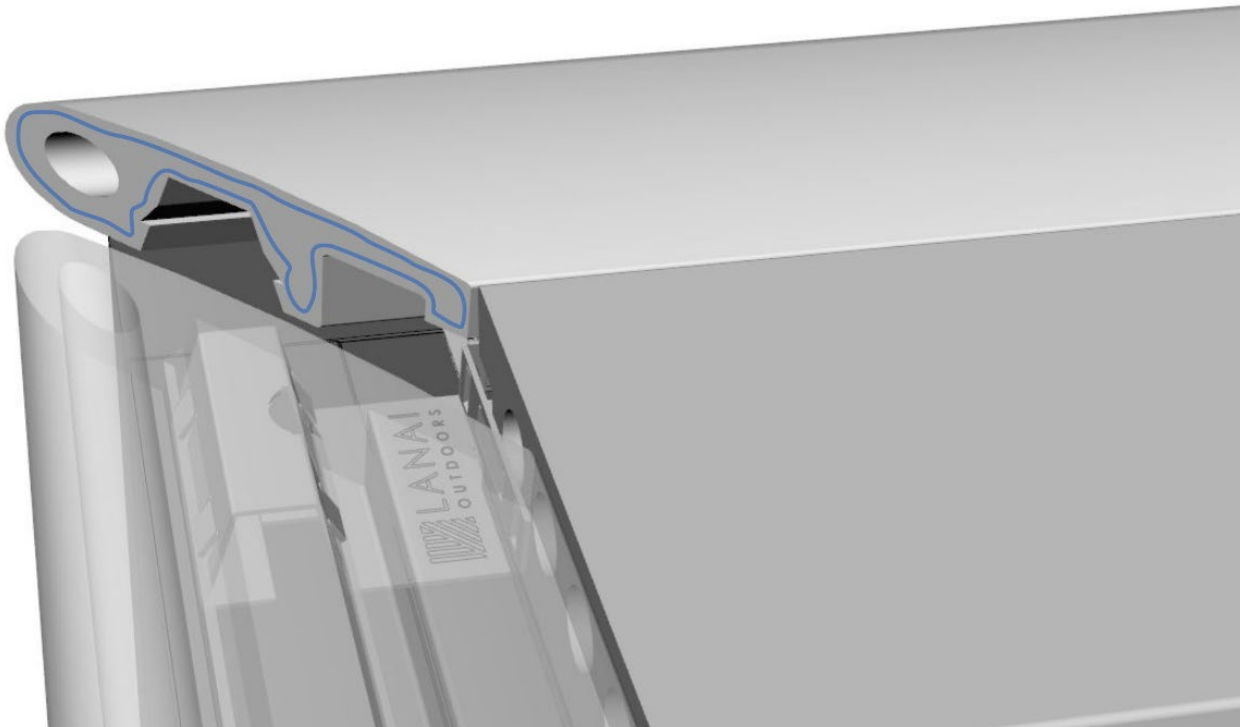

For more information, please visit our website or contact us:

www.LANAIoutdoors.com * Toll Free at 1-877-477-4373 * Email at hello@lanaioutdoors.com

INSTALLING DECK PLANKS

Now that you have your entire first row and 25" side *Deck Nosings* in place, you can begin installing your *Deck Planks*.

1. First Row:

Begin by butting the first full *Deck Plank* in the deck corner ensuring it is resting completely square against the two adjacent *Deck Nosings*.

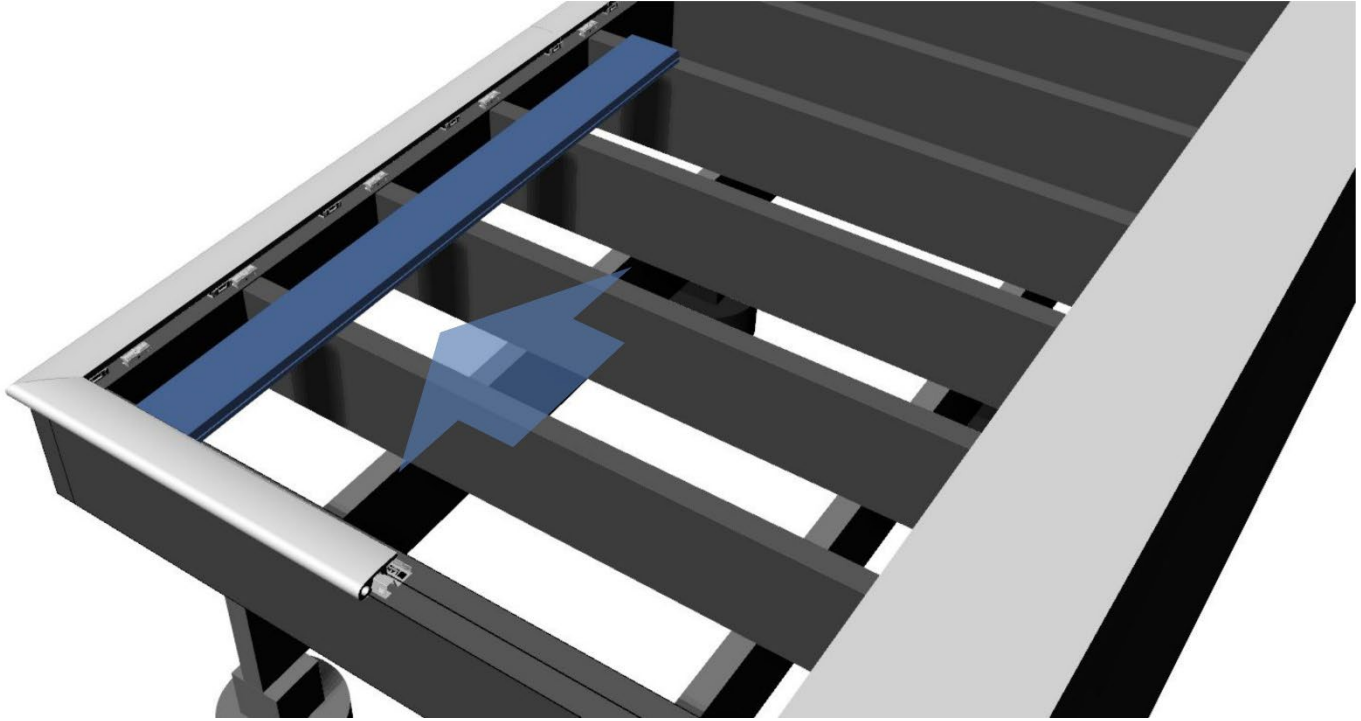

The groove of the *Deck Plank* should lock snugly with the Hidden Deck Fasteners on the starting row.

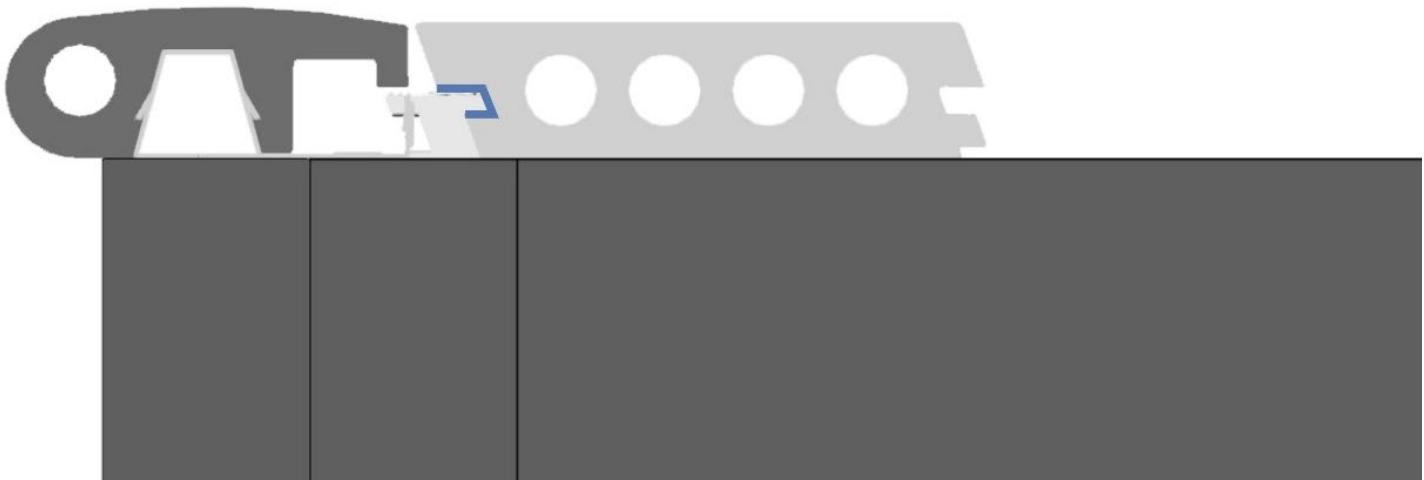

For more information, please visit our website or contact us:

www.LANAIoutdoors.com * Toll Free at 1-877-477-4373 * Email at hello@lanaioutdoors.com

Now tap that *Deck Plank* into place using the rubber mallet.

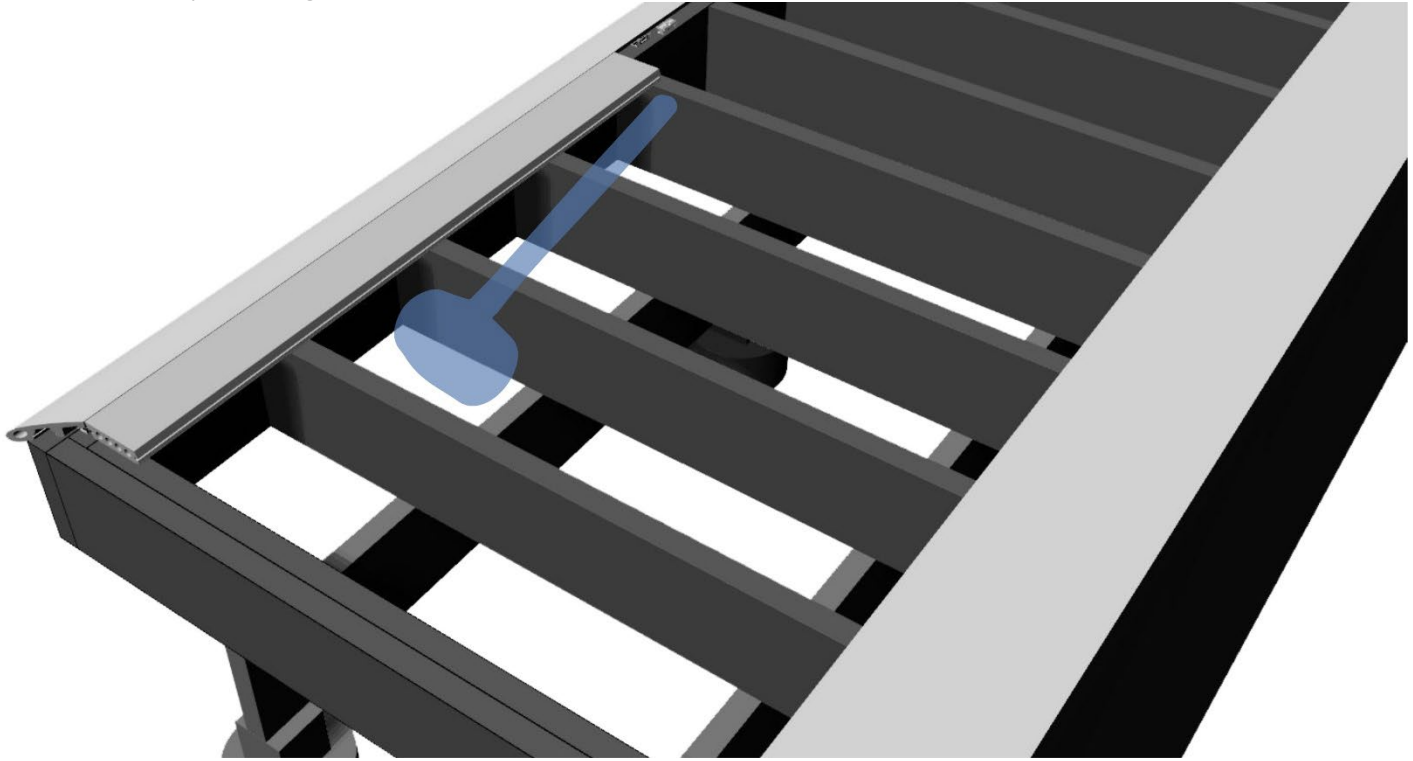

Continue putting the *Deck Planks* in the same fashion, ensuring all *Deck Plank* ends terminate on a joist. This is necessary for support, and the *Hidden Plank Fastener* on each joist will bridge the two meeting *Deck Planks*.

Deck Planks come with a slight bevel on both ends, so try to install the cut (non-bevel) edge against the side *Deck Nosing*.

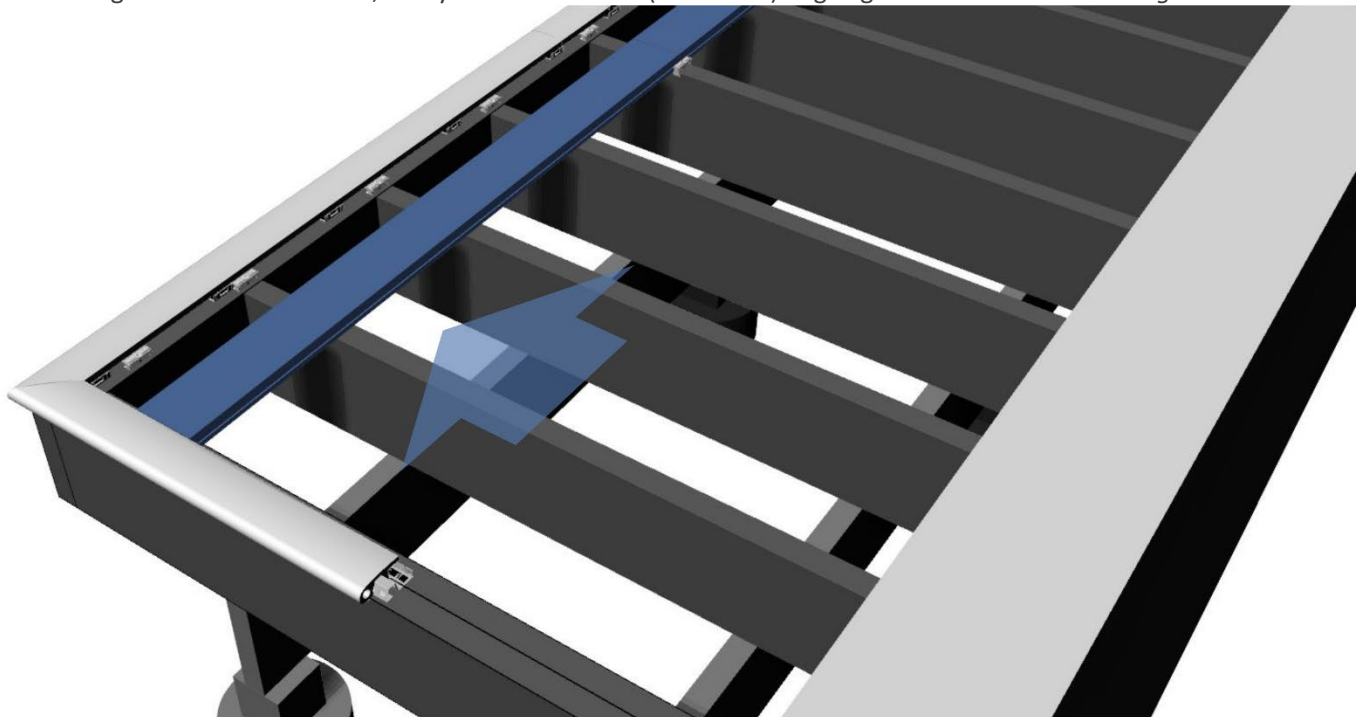

For more information, please visit our website or contact us:

www.LANAIoutdoors.com * Toll Free at 1-877-477-4373 * Email at hello@lanaioutdoors.com

Continue installing *Deck Planks* until there is less than 48" remaining in that row. When a point is reached that a *Deck Plank* needs to be cut, a miter saw with a finishing blade or diamond blade will provide the cleanest and straightest cut. Measure and cut *Deck Plank* to that size and install tight to the *Deck Nosing*.

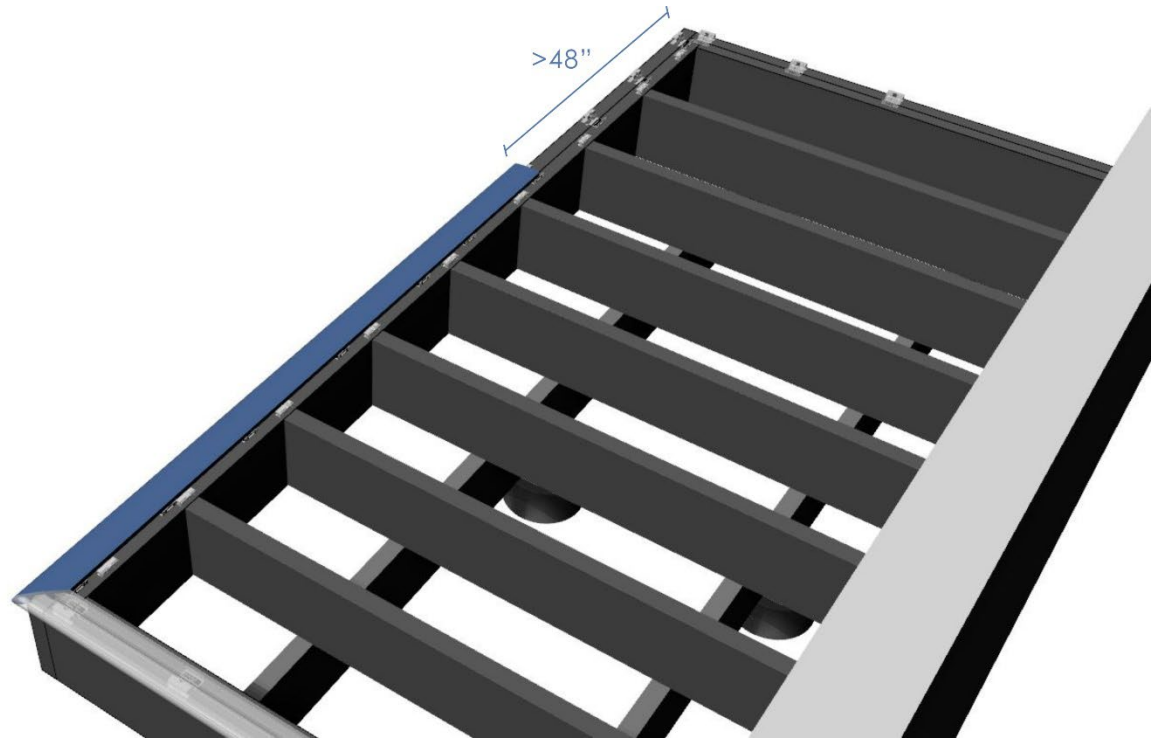

PRO TIP Use a fine sanding block on the top of the cut board to add a factory matching 'micro-bevel' to the ends of *Deck Planks*.

Now install *Hidden Plank Fasteners* to hold the other side of the of the first row of *Deck Planks*.

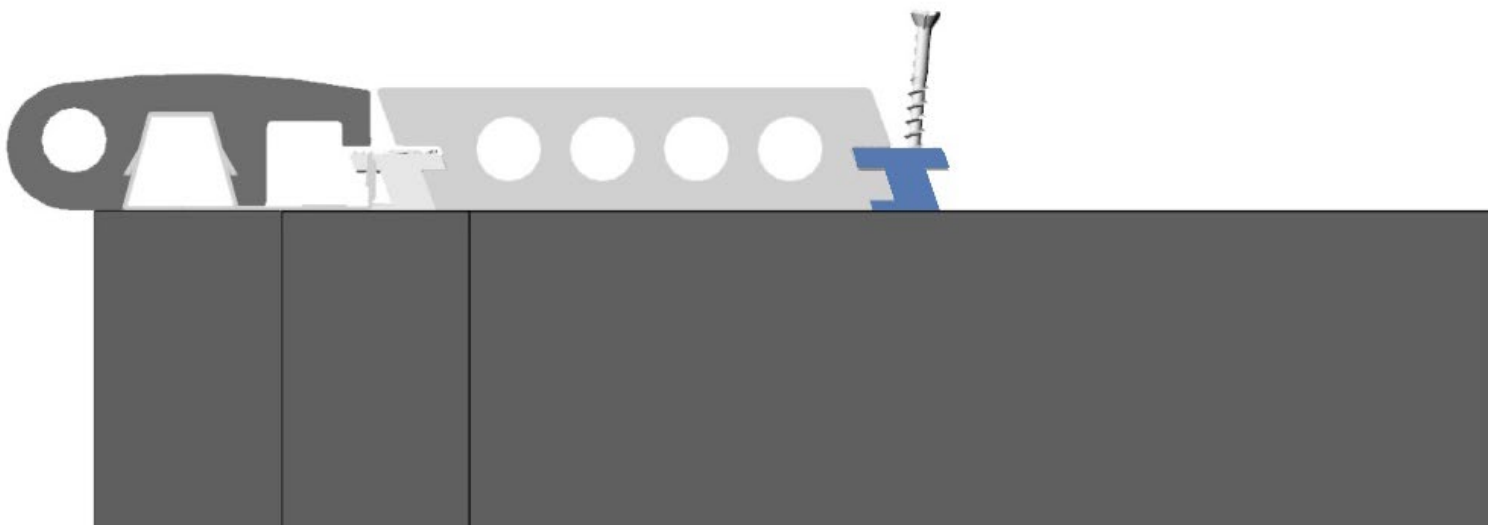

For the first *Hidden Plank Fastener* only, one of the joist-wings will need to be snapped off. Again using pliers, snap off the side that will need to sit onto the **Inner Side Joist**.

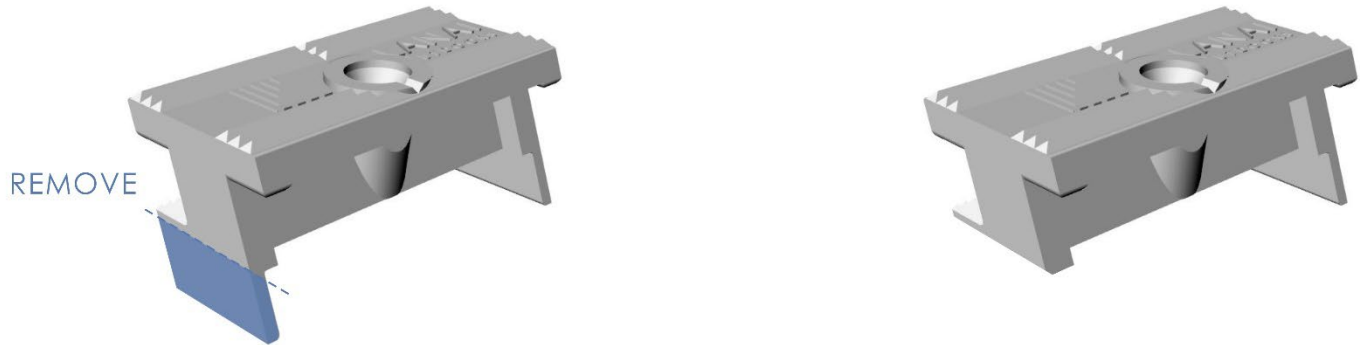

Place the *Hidden Plank Fasteners* joist-wing snug against the inside of the **Inner Side Joist** and slide into the groove on the other side of the first *Deck Plank*. Gently tap the *Deck Plank* and *Hidden Plank Fastener* with a rubber mallet to ensure they're seated correctly. Using a #1 square bit, screw the *Hidden Plank Fastener* screw down.

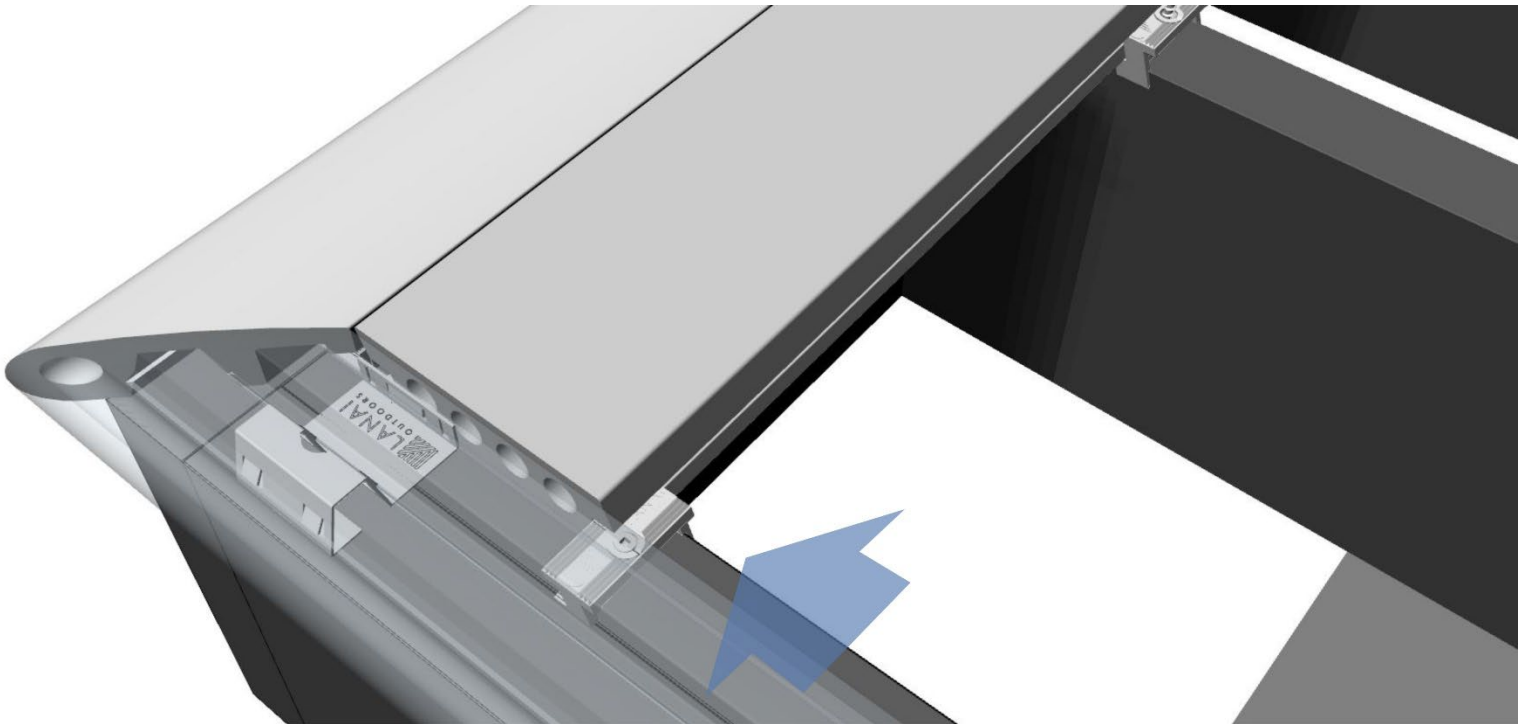

For more information, please visit our website or contact us:

www.LANAIoutdoors.com * Toll Free at 1-877-477-4373 * Email at hello@lanaioutdoors.com

Continue applying *Hidden Plank Fasteners* in this fashion to secure the *Deck Planks* on every joist.



Next Rows:

Continue installing *Deck Plank* rows in this fashion, varying the length of the first *Deck Plank* in each row.

For 12" on center framing – Planks can be 12", 24", 36", and 48"

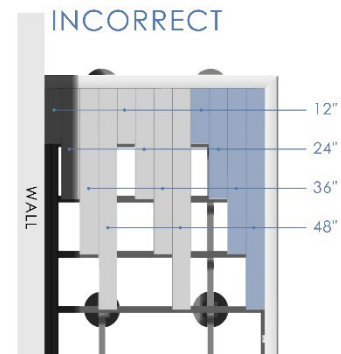
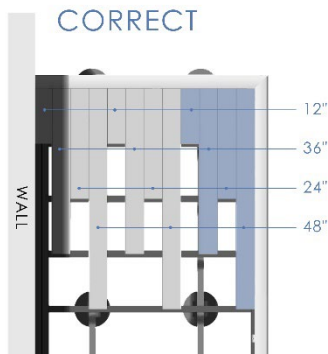

For 16" on center framing – Planks can be 16", 32", and 48"

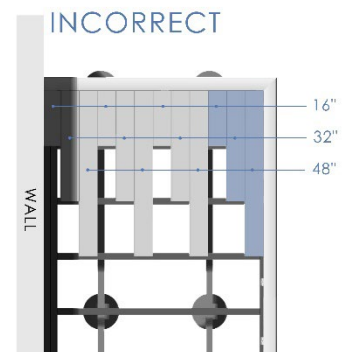
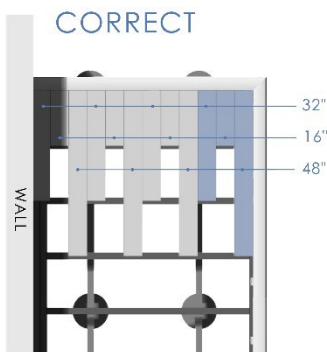

For more information, please visit our website or contact us:

PRO TIP To avoid waste, use the cut piece from a previous row and cut that down to one of the usable sizes below. For the most naturally varied look, try to avoid an even stagger.

Continue until you are close to the end of the two outside *Nosing Planks* installed, which should be 5 *Deck Plank* rows.



If everything is square, finish installing the *Deck Nosing* on both sides, installing tight against the wall.

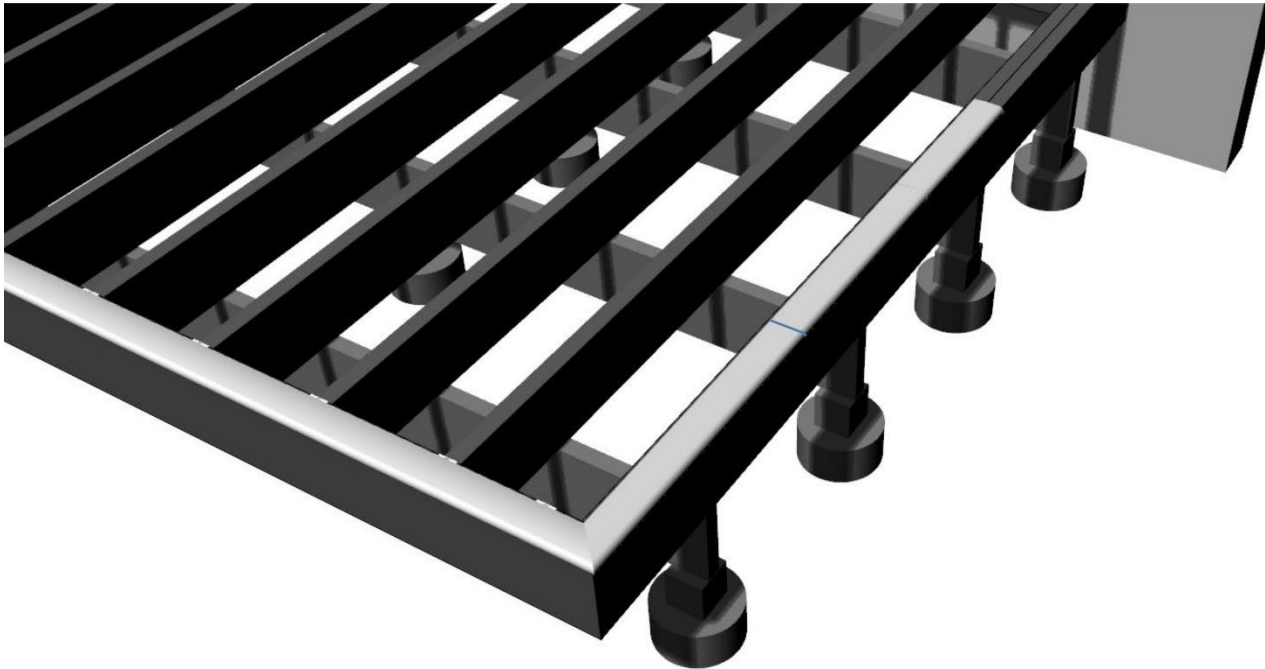

Now continue to install all rows of *Deck Planks* until you are less than 4" from the wall.

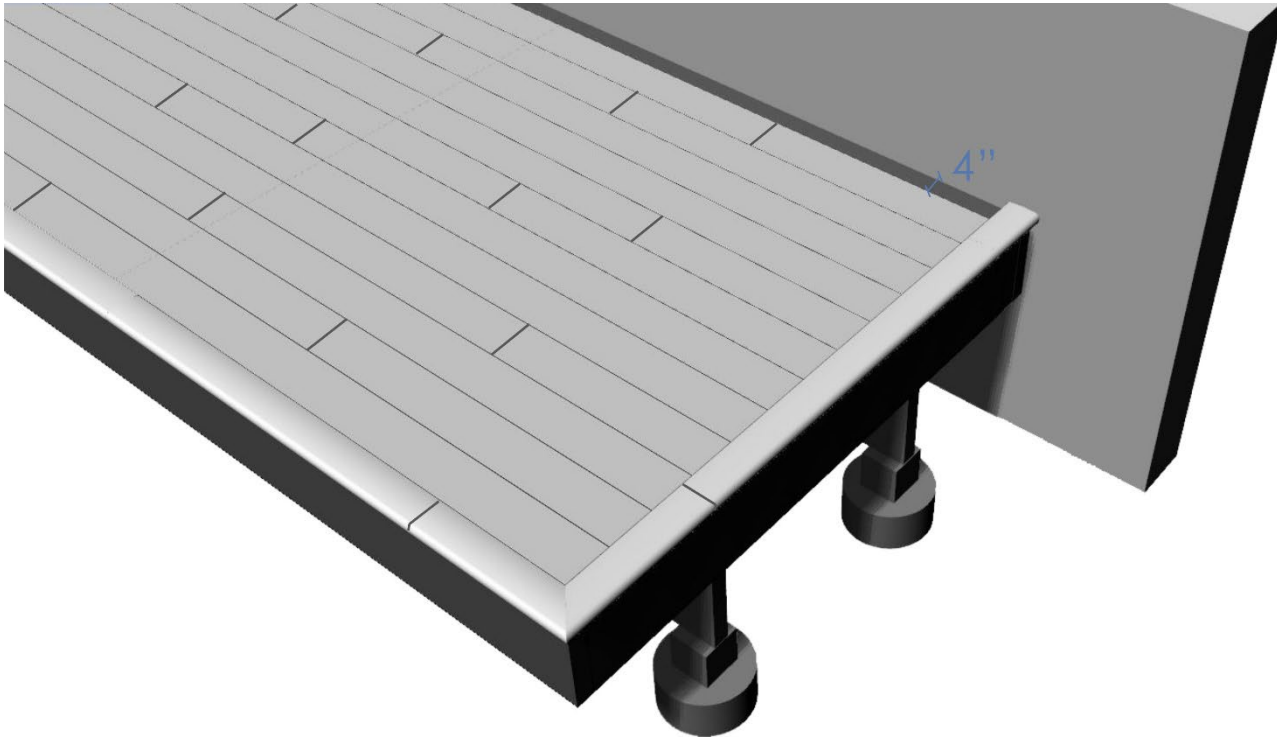

Final Row:

For most installations, a full *Deck Plank* will not fit as the final row (against the wall). If it works out perfectly that slightly more than 4" is remaining, then you can use a full *Deck Plank*. If the fit is too tight, you may need to cut off the angled bevel on the side of the plank facing the house/building.

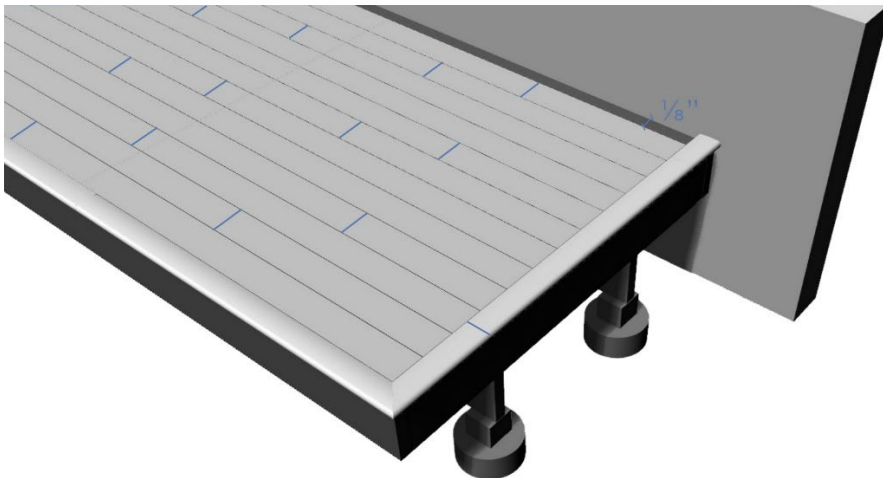

If there is less than 4" remaining, measure the space remaining and subtract 1/8". Measure, mark, and cut the *Deck Plank* lengthwise to fit. These should be dry fit first and then fastened down as only the one side will have a groove to fit into the *Hidden Plank Fastener* from the previous row.

For more information, please visit our website or contact us:

Now fasten the *Deck Riser* using one of two methods:

If using screws, we recommend color-matched composite deck or fascia screws. Place them 1 inch in from the end of each *Deck Plank*, and every 12 inches in between.

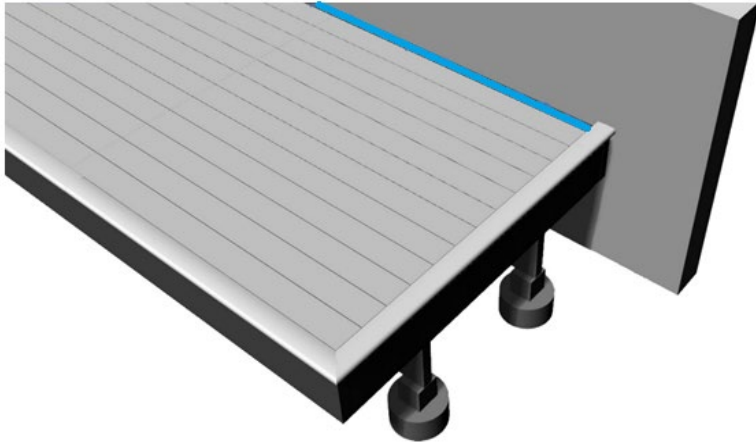

If using adhesive, always ensure that freeze/thaw or expansion/contraction will not be an issue. If you are unsure, it is best to use the screw method above.

Apply adhesive in along the center of the **Wall Joists** that are exposed. Then install the *Deck Planks* and apply light pressure to ensure a level finish. We recommend using Titebond TiteGrab, or an equivalent 'heavy duty construction adhesive'.

LANAI recommends Titebond PVC TRIM Adhesive if it is available. It does not have as a high tack, so you will likely need to use finishing nails, tape, clamps, or something else to hold it in place while it sets.

Otherwise, use a heavy-duty construction adhesive that is suitable / compatible with PVC.

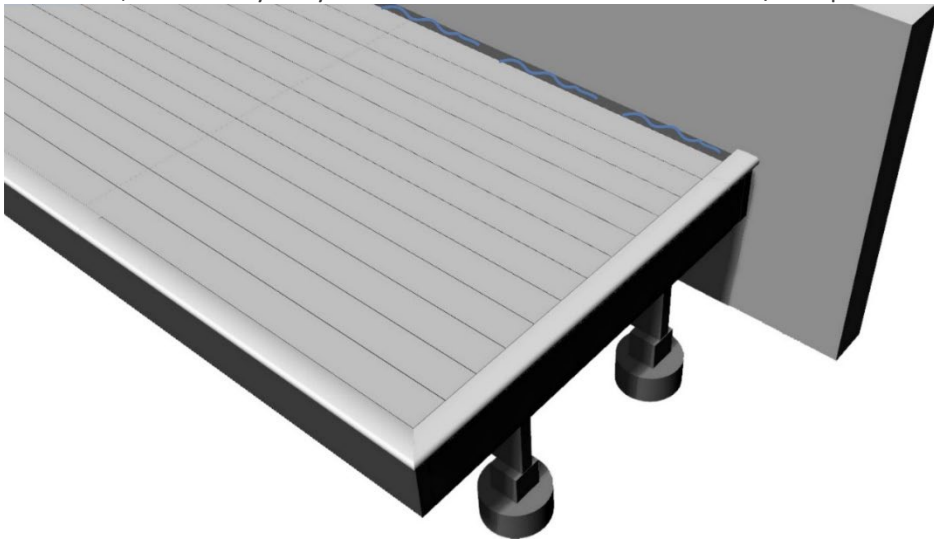

PRO TIP *Roughen up the back of the Deck Planks with sandpaper, a rasp, a metal brush, or something similar. Then ensure it is 100% free of dust and debris. This will provide a stronger adhesion.*

For more information, please visit our website or contact us:

www.LANAIoutdoors.com * Toll Free at 1-877-477-4373 * Email at hello@lanaioutdoors.com

INSTALLING DECK FASCIA

There are two ways to start your *Deck Fascia* installation, either with a butt joint or a mitered joint.

We recommend mitered corners for the *Deck Fascia* for the cleanest and most continuous look, but make sure they are very tight together to prevent any potential chipping or damage as the finished edge will be very thin.

PRO TIP Try to have the seams of the *Deck Fascia* match the seams of the *Deck Nosing* above them. Follow the instructions below to achieve this look.

If doing a mitered corner, start at an outside corner and measure the distance from the seam on the *Deck Nosing* to the edge of the deck. Add $\frac{1}{4}$ " (fascia thickness) to that measurement and mark that distance to the frontside of the *Deck Fascia*. 45-degree corner (cut at an angle that will create a longer measurement on the face) at the edge of the *Deck Fascia* that will be at the edge of the deck.

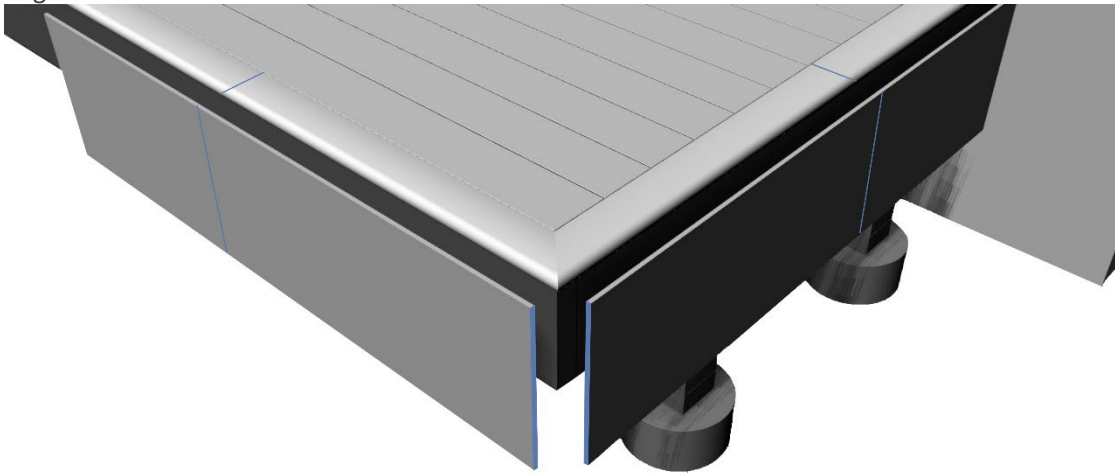

If doing a butt corner, start at an outside corner and measure the distance from the seam on the *Deck Nosing* to the edge of the deck. Mark that distance to the frontside of the *Deck Fascia* and cut to that distance and ensure that it meets up tight with the corner on one end and the *Deck Nosing* seam on the other end.

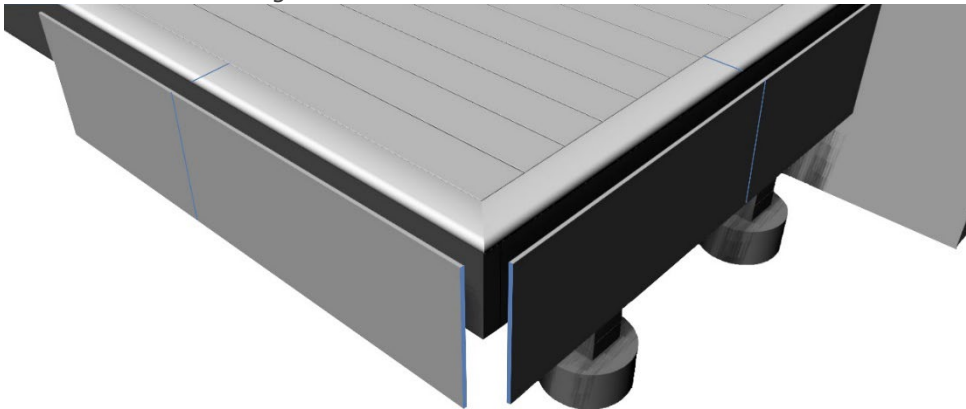

For more information, please visit our website or contact us:

www.LANAIoutdoors.com * Toll Free at 1-877-477-4373 * Email at hello@lanaioutdoors.com

Now it is time to fasten the first piece, using one of two methods:

Screws

(This is our recommended method as it works in every climate and condition)

Find a close color-matched composite deck or fascia screws, such as FastenMaster TrapEase. If you cannot find the exact ones below, there are many brands and colors that will work:

- Beach Wood – Beach Dune recommended
- Sunset Palm – Saddle recommended
- Dark Kona – Lava Rock recommended
- Black Sand – Woodland Brown recommended

You will pre-drill holes using the Counterbore Tool, and then fasten screws using the Driver Bit.

Starting at the edge, install screws 1" from the corner and then every 12", with three screws across the face at each interval.

Once there is less than 48" remaining to the wall or end-point, measure and cut the final *Deck Fascia*. If it is butting up to a house/building, simply measure the distance remaining and mark the *Deck Fascia* on the face for that cut. If it is going to be another corner, make the 45-degree angle or butt joint as per the instructions used above for the first *Deck Fascia*.

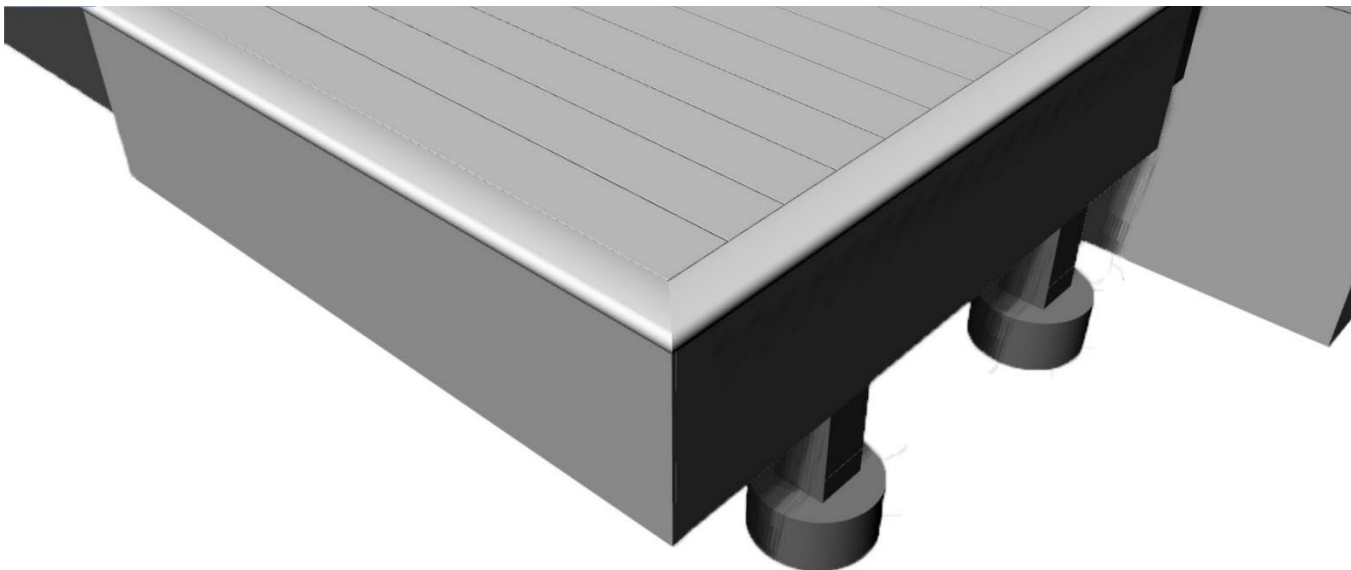
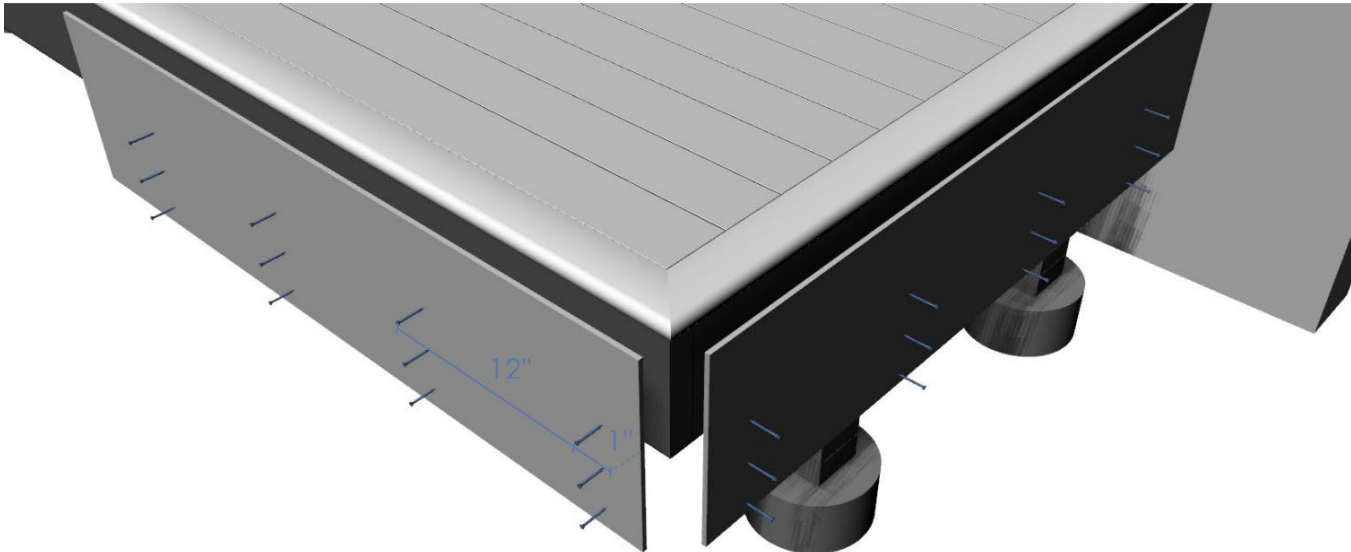

For more information, please visit our website or contact us:

www.LANAIoutdoors.com * Toll Free at 1-877-477-4373 * Email at hello@lanaioutdoors.com

Adhesive:

If using adhesive, always ensure that freeze/thaw or expansion/contraction will not be an issue. If you are unsure, it is best to use the screw method above.

Once the *Deck Fascia* is ready to install, ensure that all dust and debris is wiped off the back of the *Deck Fascia* and the Joist you are adhering to. Then apply a continuous bead of construction adhesive to the back of the *Deck Fascia* 1-2" from the 4 edges of the back (smooth side), and then in a serpentine shape in the middle. Then put in place and apply pressure across all areas of the *Deck Fascia* adequate spreading of the adhesive. Painter's tape or appropriate clamps can be used to help keep the *Deck Fascia* in place while it sets.

LANAI recommends Titebond PVC TRIM Adhesive if it is available. It does not have as a high tack, so you will likely need to use finishing nails, tape, clamps, or something else to hold it in place while it sets.

Otherwise, use a heavy-duty construction adhesive that is suitable / compatible with PVC

PRO TIP Roughen up the back of the *Deck Fascia* or *Deck Risers* with sandpaper, a rasp, a metal brush, or something similar. Then ensure it is 100% free of dust and debris. This will provide a stronger adhesion.

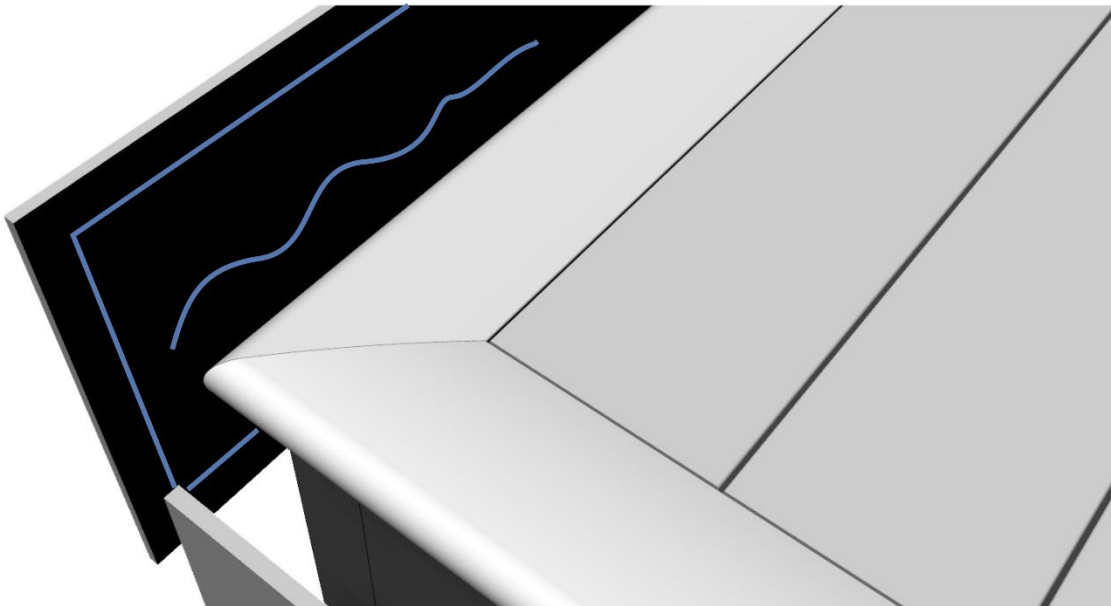

For more information, please visit our website or contact us:

www.LANAIoutdoors.com * Toll Free at 1-877-477-4373 * Email at hello@lanaioutdoors.com

INSTALLING COMPLETE

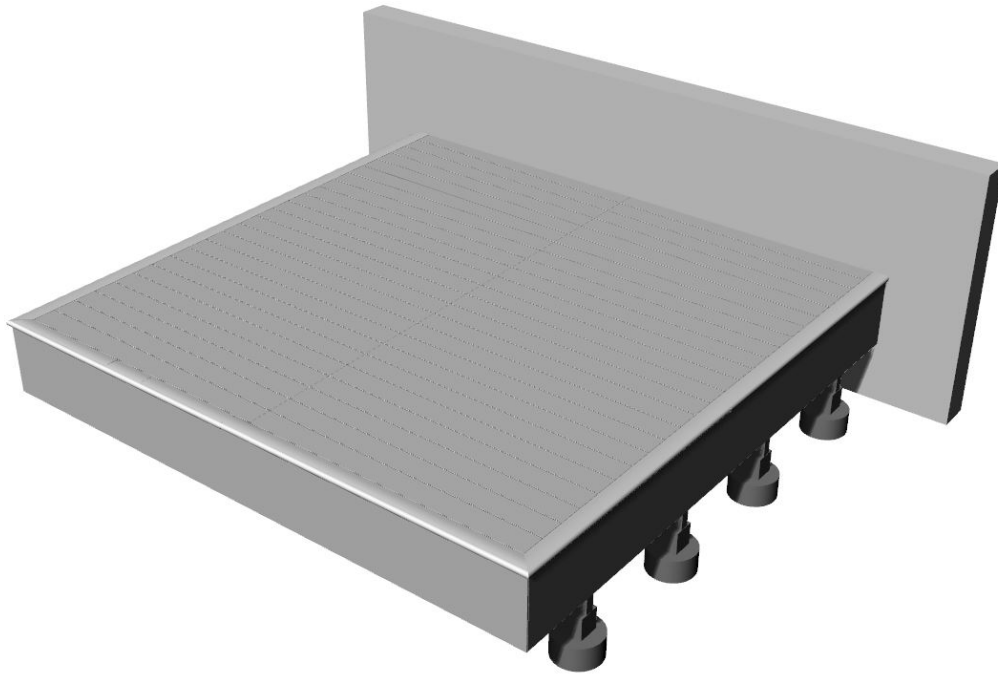
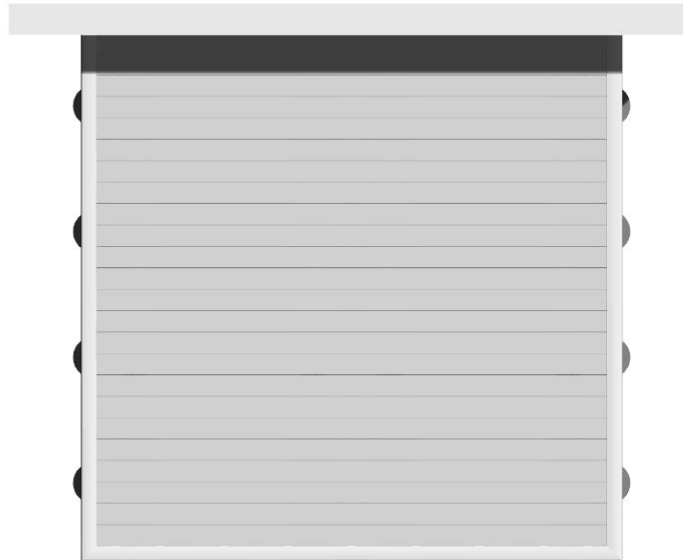

DISCLAIMER:

LANAI OUTDOORS INC. (LANAI) does not install or have any control over how product is installed, therefore these Instructions are to be used as only as guidelines. LANAI assumes no liability for improper installation or personal injury resulting from proper or improper use or installation.

For more information, please visit our website or contact us:

www.LANAIoutdoors.com * Toll Free at 1-877-477-4373 * Email at hello@lanaioutdoors.com