

# Ultra Tower Max User Manual

Before using: For Your safety, please read and understand this manual before using your product.

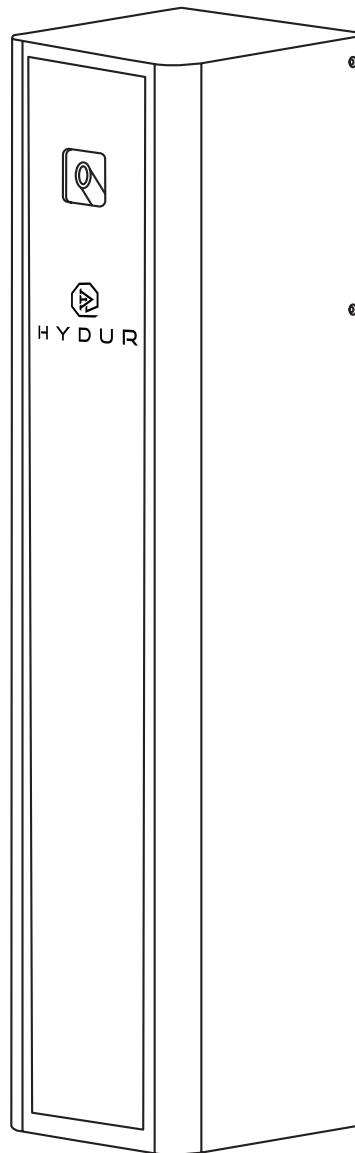

20 Scent Intensity  
Schedules

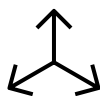

Up to 830sqm  
Coverage



1000ml Oil  
Capacity



Mobile App  
Bluetooth Operated

**Product Name:** Ultra Tower Max

**Coverage:** Up to 830m<sup>2</sup>/2500m<sup>3</sup>/88000ft<sup>3</sup>

**Dimensions:** (H) 664 mm x (W) 152 mm x (D) 150 mm

**Net weight:** 7.18 kgs

**Gross weight:** 7.85 kgs

**Oil Consumption:** 0.30 ml – 3.70 ml per hour

**Power:** 10 Watts

**Voltage:** DC12V

**Container capacity:** 1000 ml

**Accessories:** Power adapter

**Suitability:** Home, Retail, Commercial, Large Spaces, Halls, Lobby



Waste electrical products should not be disposed of with house hold waste. Separate disposal facilities exist, for your nearest facilities see [www.recycle-more.co.uk](http://www.recycle-more.co.uk)

## Specification

---

Our Ultra Tower Max takes home, office, retail and commercial scenting and aromatherapy to a whole different level. It is sleek and powerful that the diffuser can scent up to 800 square meters, creating a wonderful and relaxing ambiance for your home, office, shop, or commercial spaces.

Our technologically advanced scent diffuser use nebulisation, patented ultrasonic technology and is easy to use, modern, healthier and a safer alternative to Bakhoor, Candles and Incense. Unlike other scenting options, our Ultra Tower Max Diffuser does not require heat or water. The scenting oil is broken down into ultra dry nanoparticles, diffusing it into the air, leaving every room in your house, office, shop smelling of natural aromas.

The Ultra Tower Max comes with an adjustable scent intensity setting and the ability to custom scent schedule your scent diffusion based on your preferred time and day using our dedicated Hydur Scenting Bluetooth Mobile Application. With sufficient scenting oil storage, the Ultra Cylinder Max will diffuse for a long period of time before needing a refill.

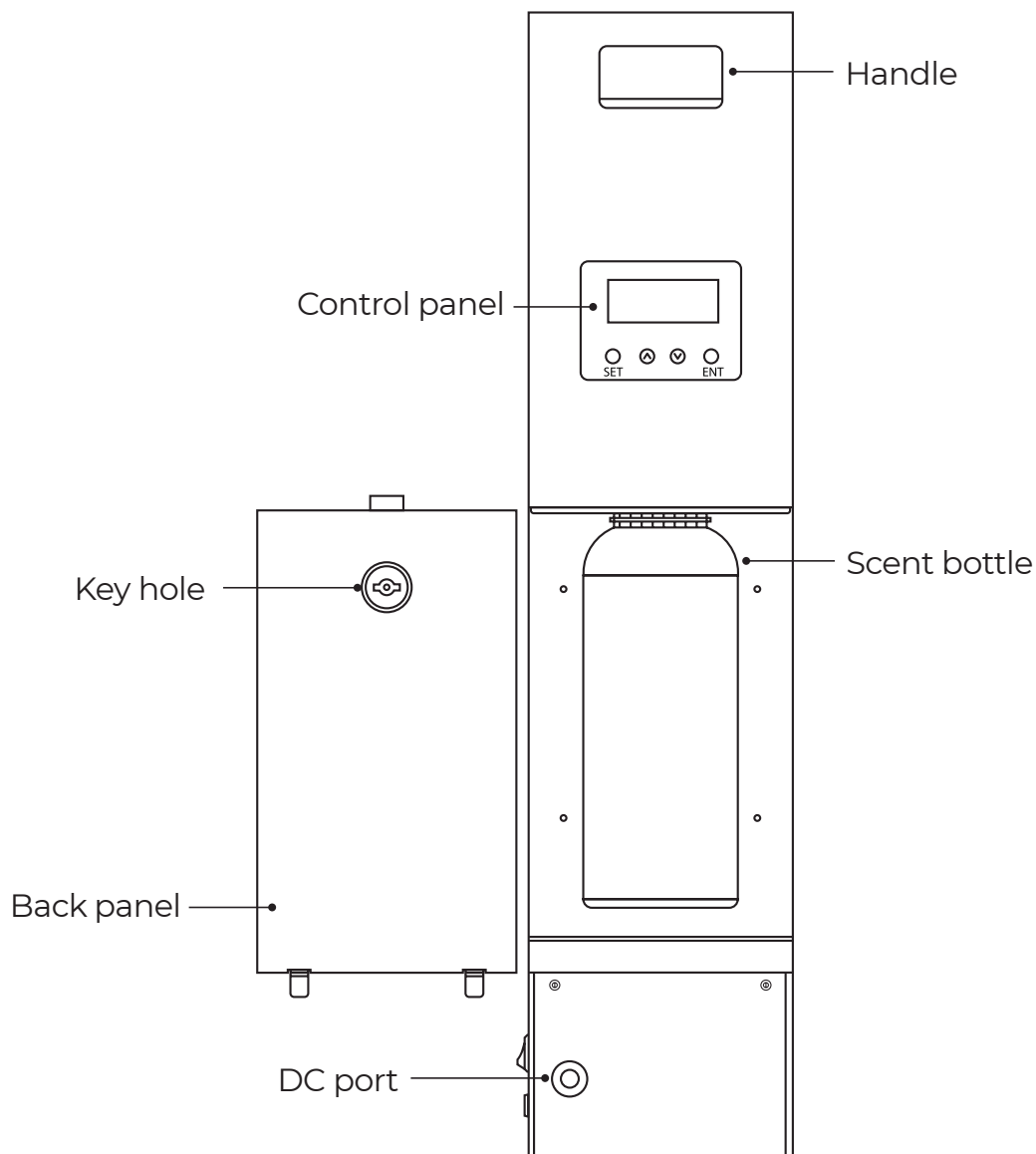

## Operating your diffuser

---

- 1 Using the key, unlock the back cover and remove the panel.

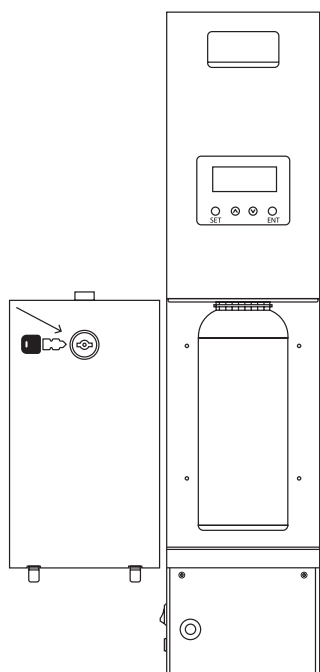

- 2 Unscrew the scent bottle and carefully take it out of the machine.

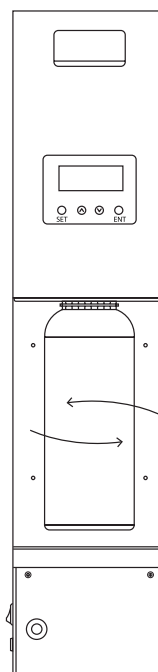

- 3 Fill the bottle with scenting oil and screw it back to the machine.

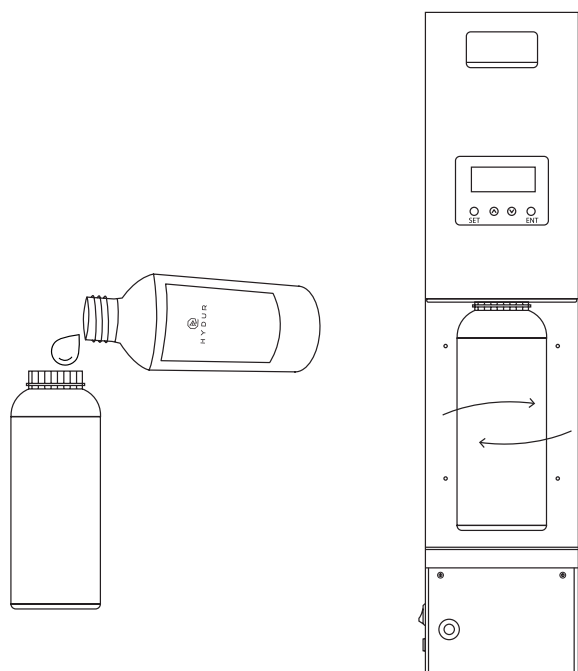

- 4 Keep the machine upright and securely place the back panel and lock it with the key.

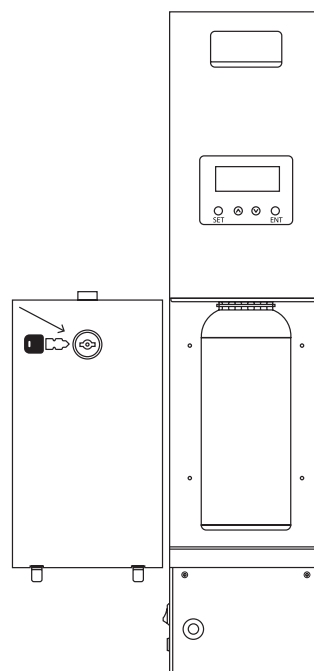

- 5 Plug in the power adapter and turn the machine ON, the machine will beep to indicate its ON and ready to operate.

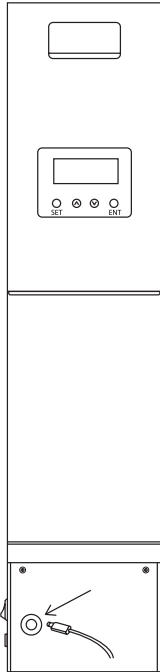

- 6 Adjust the desired intensity level by connecting to the Hydur Scenting app bluetooth. The app allows you to control your diffusion levels and settings based on your preferred day and time. The Hydur Scenting controller app is available to download on IOS or android. You may also configure the setting using the control panel.



- 7 Place your Ultra Tower Max Diffuser in conference rooms, hotel lounges, restaurant, salon, meeting room, office, or any ventilated indoor space.

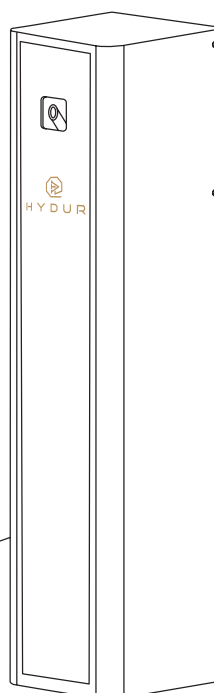

# How to set & control your scent intensity settings

- 1 Download and open the Hydur Scenting Controller App.

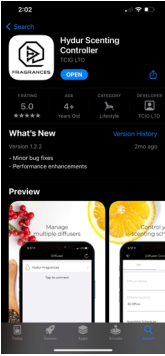

- 2 Select the Scent Diffuser from the list.

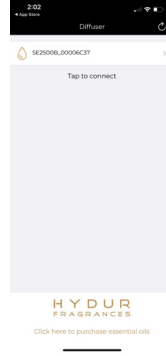

- 3 Log in using the default password '8888.'

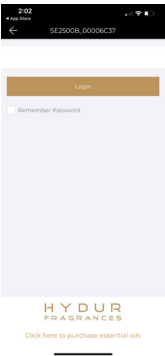

- 4 Tap the '+' or 'Add' button to add scenting schedule.

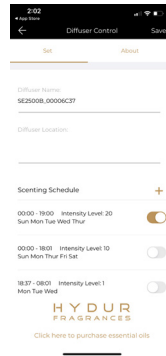

- 5 Select the desired Start and End Time.

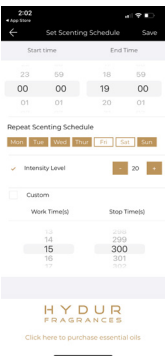

- 6 Adjust the intensity level and tap 'Save.'

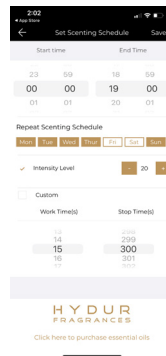

Hydur Scent Diffuser can work continuously or intermittently, depending on your settings. We recommend that you schedule your scent diffusion intermittently between one to three times a day for up to 1 hour at the maximum.

Set your intensity to the maximum level on the first cycle of scenting and reduce the intensity on the next cycles.

## Power On

---

Connect the DC12V adapter to the outlet and turn the power switch On. Local time and scent intensity levels will appear.

## Intensity and Oil Consumption

It takes approximately 3.5 hours for the diffuser to be fully charged (recommended) and will last approximately 24 hours in standby mode.

Intensity Level Indicator Light	Length of Diffusion	Interval Between Diffusion	Oil Consumption (ml/hr)
1	15 secs	5 mins	0.30 ml
2	15 secs	2.5 mins	0.40 ml
3	20 secs	2 mins	0.60 ml
4	20 secs	1.25 mins	0.70 ml
5	25 secs	1.20 mins	0.80 ml
6	30 secs	1.15 mins	1.00 ml
7	30 secs	1 min	1.10 ml
8	30 secs	50 secs	1.20 ml
9	30 secs	40 secs	1.30 ml
10	30 secs	33 secs	1.50 ml
11	33 secs	30 secs	1.70 ml
12	40 secs	30 secs	1.90 ml
13	50 secs	30 secs	2.20 ml
14	60 secs	30 secs	2.40 ml
15	75 secs	30 secs	2.60 ml
16	80 secs	25 secs	2.80 ml
17	85 secs	20 secs	3.00 ml
18	120 secs	20 secs	3.30 ml
19	150 secs	15 secs	3.50 ml
20	300 secs	15 secs	3.70 ml

## Safety Care

---

- Unplug the diffuser immediately and discontinue use in the event of smoke or a burning smell
- Do not wrap the adaptor with cloth, paper, or anything that may result to avoid abrasions, cuts, fraying, crimping, and kinking
- Do not disassemble or attempt to self-repair the diffuser, this will void the warranty. Any damage caused by the user does not qualify for replacement by Hydur
- Disconnect the diffuser from power adaptor before refilling, cleaning or moving the diffuser
- Clean the sensor with a isopropyl alcohol-soaked cotton swab
- Do not use metal objects to clean the sensor; use only a cotton swab or cloth dipped in isopropyl alcohol or a neutral detergent
- Make sure to clean the unit before switching to different scenting oils
- Use only essential oils or Hydur scenting oils. Artificial, synthetic, or impure oils and fragrances can damage the diffuser.
- Avoid placing the diffuser in direct sunlight, close to a refrigerator or fan, or in a hot environment
- When not in use, clean the diffuser and store dry at 0°C—50°C, 5%-95% humidity.

## Taking Care of your Storage

---

To keep your diffuser clean and ensure the best mixture of Hydur Fragrances it is recommended that you perform a cleaning cycle on your diffuser at least once a month, if you use your diffuser daily or in case any of these situation happens:

- Switch or change to another Scenting Oil
- Atomization volume becomes weak or there is no mist or less mist than usual

To do a cleaning cycle on your diffuser, follow these steps:

Step 1: Turn the device off and unplug prior to cleaning.

Step 2: Gently wipe the plate using a cotton swab dipped in rubbing/isopropyl alcohol.

Step 3: Fill a clean bottle with isopropyl alcohol.

Step 4: Install the bottle filled with rubbing alcohol to the diffuser and turn it on. Let it diffuse for 5-20 minutes or until the essential oil scent wears off.

Step 5: Replace the bottle of rubbing/isopropyl alcohol with your scenting oil.

## Disposal

---

Dispose of this product and packaging materials with your local regulation. Waste electrical products should not be disposed with household waste. Separate disposal exist for your nearest facilities, see [www.recycle-more.co.uk](http://www.recycle-more.co.uk)



## Troubleshooting

Condition	Solution
Diffuser is not working.	<p>USB cable or power plugged may not be properly plugged in or your diffuser ran out of battery (if battery operated).</p> <ul style="list-style-type: none"><li>• Check if the power is on or off and or your diffuser is charged or plugged in.</li><li>• Check if there is a scented oil inside the bottle.</li></ul>
No mist coming out of my diffuser.	<p>Your atomizer head might be blocked.</p> <ul style="list-style-type: none"><li>• Check if there is any scented oil build up on the plate. In case there is a buildup, follow the cleaning instructions.</li></ul>
Diffuser is leaking.	<p>Your diffuser head is either displaced or the the diffuser is tilted.</p> <ul style="list-style-type: none"><li>• Check that the diffuser head is screwed properly to the bottle.</li><li>• Make sure that the diffuser is set on a hard, flat surface.</li><li>• Keep the diffuser constantly vertical do not tilt or keep the diffuser horizontal.</li></ul>
Scent is too strong or too weak.	<p>If you find the mist/intensity is too strong or weak, adjust the diffuser intensity to either a higher or lower setting to suit your preference.</p>

### **What is the average oil consumption of a Ultra Tower Max?**

Average scenting oil consumption ranges from 0.30 ml – 3.70 per hour.

### **How much area does a Ultra Tower Max covers?**

An Ultra Tower Max will cover up to 830 square meters.

### **How long will my 100ml Scent last?**

A 1000 ml bottle can last approximately 1 month, depending on the intensity settings and diffusing times.

### **Do I need to put water on the diffuser?**

No. Hydur Diffuser does not use water. It atomize the scenting oils using a series of tubes, dispersing the oils in their purest form.

### **What type of oils can I use on the diffuser?**

Hydur Diffuser diffuses 100% essential oil or Hydur Scenting Oil. Other blends and oils may contain fragrances, base oils or synthetics that could result in malfunction. Hydur Scenting Oils are carefully blended and curated for Hydur Diffusers.

### **Do I need to clean the diffuser?**

Yes. It is recommended that you perform a cleaning cycle at least once a month.

### **How do I reset the password of the Hydur Scenting App?**

In case you forget the password, simply press the reset button to restore to factory settings. The default password is 8888.

### **How do I create a scenting schedule from the Hydur Scenting App?**

The scent scheduling feature is only available on Grandi Square, Grandi Tower and Ultra Tower Max.

To create a new scenting schedule using the app, simply:

Step 1: Select "Add New" under the "Schedule" section on the Homepage

Step 2: Choose to create your own schedule, or select one of the pre-set schedules

Step 3: Enter your desired Start time, End time, Name and intensity. If you would like the schedule to repeat, select the day(s) you would like it to repeat.

Step 4: Click "Save"

### **Will my diffuser work even if I am not connected to the Hydur Scenting App?**

Yes. The diffuser will keep the schedules you have set. Once you reconnect via Bluetooth you can change the schedules, adjust the scent intensity or turn the diffuser off manually.