

S Y N C A

USER MANUAL

**CirC**

**Compact Massage Chair**

**MR320**



Before using, please read this USER MANUAL carefully

Thank you for your purchase of this product. Before using, please read this USER MANUAL carefully, and pay special attentions to the safety precaution to ensure proper operation and use.

Please keep this USER MANUAL for further reference.

## CONTENTS

SAFETY PRECAUTIONS -----	1
NAME AND FUNCTION OF EACH COMPONENT-----	4
External structure -----	4
Internal structure -----	4
Controller -----	5
How to use the Controller-----	6
Installation -----	9
Installation position -----	9
Floor protection -----	9
Surrounding environment -----	9
How to Install -----	9
How to move -----	10
Turn on power supply -----	10
PRODUCT STORAGE AND MAINTENANCE-----	11
TROUBLE SHOOTING -----	12
TECHNICAL SPECIFICATIONS -----	13

## TECHNICAL SPECIFICATIONS

Name: CirC-Compact Massage Chair

Model: MR320

Rated voltage: 110-120V~

Rated frequency: 60 Hz

Rated Current: 0.45A

※Use only with on the designated voltage

## TROUBLE SHOOTING

No.	Problem	Possible Cause	Solution
1	When a pulling or light popping sound is heard	This is a normal sound made by the working motor or the sound is produced when the massage ball is rubbing against the cloth cover.	This is normal and no repair is needed.
2	The chair wont power on	The chair isn't plugged in	Plug the chair in
		The power supply switch is turned off	Turn on the switch
		The fuse of massage chair has blown.	Replace the fuse with a new one

If abnormal issues still remain after the above measures have been taken, please contact your local dealer for repair and maintenance

Note: Do not dismantle the product by yourself. Our company will bear no responsibility for the damage to the product or injury of any people caused by improper use/repair/maintenance! Thanks for your cooperation.

### Replace the fuse

- ▶ Make sure the chair is powered off and unplugged.
- ▶ Use a flathead screwdriver to pull out the fuse as displayed in pic. 1.
- ▶ Remove the old fuse and replace with a new fuse of the same power as displayed in pic. 2.

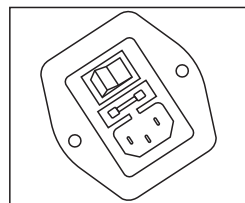
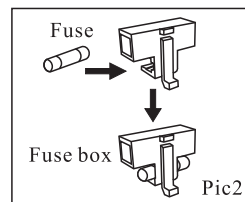
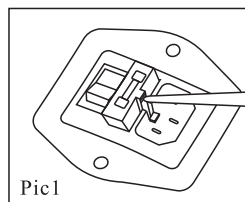
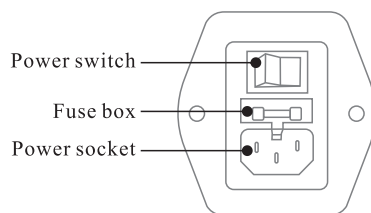

## SAFETY PRECAUTIONS

### IMPORTANT SAFETY INSTRUCTIONS

Read all instructions before using (this appliance).

**DANGER**-To reduce the risk of electric shock:





- 1) Always unplug this appliance from the electrical outlet immediately after using and before cleaning.
- WARNING**-To reduce the risk of burns, fire, electric shock, or injury to persons:
  - 1) An appliance should never be left unattended when plugged in. Unplug from outlet when not in use, and before putting on or taking off parts.
  - 2) Do not operate under blanket or pillow. Excessive heating can occur and cause fire, electric shock, or injury to persons.
  - 3) Close supervision is necessary when this appliance is used by, on, or near children, invalids, or disabled persons.
  - 4) Use this appliance only for its intended use as described in this manual. Do not use attachments not recommended by the manufacturer.
  - 5) Never operate this appliance if it has a damaged cord or plug, if it is not working properly, if it has been dropped or damaged, or dropped into water. Return the appliance to a service center for examination and repair.
  - 6) Do not carry this appliance by supply cord or use cord as a handle.
  - 7) Keep the cord away from heated surfaces.
  - 8) Never operate the appliance with the air openings blocked. Keep the air openings free of lint, hair, and the like.
  - 9) Never drop or insert any object into any opening.
  - 10) Do not use outdoors.
  - 11) Do not operate where aerosol (spray) products are being used or where oxygen is being administered.
  - 12) To disconnect, turn all controls to the off position, then remove plug from outlet.

SAVE THESE INSTRUCTIONS



## SAFETY PRECAUTIONS

### Safety Precautions

- ▶ Before using, please read these "SAFETY PRECAUTIONS" carefully to ensure proper operation.
- ▶ The following "SAFETY PRECAUTIONS" are of great help to ensure correct usage of this massage chair.

 <b>WARNING</b>	Improper operation may cause product damage.
 <b>CAUTION</b>	Improper operation may cause injury to users.
 Forbiden. Specific instructions will be indicated in the diagram drawings. (E.g,the left drawings means disassembly is not allowed.)	
 Mandatory instructions will be indicated in the diagram drawings. (E.g,the left drawing means to disconnect the power plug)	

### WARNING

 <b>COMPULSARY</b>	We recommend that anyone with the following conditions should consult a doctor before using. 1.Those who are using electronic medical instrument imbedded in the body, such as a cardiac pacemaker etc. 2.Those who are currently being treated by a doctor, especially those who feel uncomfortable or unwell. 3.Those who are suffering from malignant tumors, heart disease, or other serious medical conditions..
 <b>PROHIBITED</b>	♦Do not allow the mentally disabled to use the chair unsupervised. ♦Do not allow children play on or use the massage chair. ♦Do not allow more than one person to use the massage chair at a time. ♦If the power cord or power plug becomes damaged in any way you must disconnect from the power supply immediately and consult an authorized service provider for repair or replacement.
 <b>NO DISASSEMBLY</b>	Anyone else, except maintenance personnel specified by our company, should not disassemble, maintain, or remodel this massage chair. If there are any problems, please contact your local dealer immediately.

## PRODUCT STORAGE AND MAINTENANCE

### 1. Cleaning

- ▶ Before cleaning, make sure that the plug has been pulled out from the socket. Use a piece of cloth that has been moistened with cleaner to wipe the main unit of massage chair, and then use a piece of dry soft cloth to wipe it down.

### Caution

- ▶ Do not use corrosive cleaning agents like benzene or thinner to clean the massage chair,otherwise, the color of upholstery will fade or the massage chair fabric will crack and erode. Do not iron the upholstery.

### 2. Maintenance

- ▶ Make sure that the chair has been unplugged.
- ▶ Sweep off or vacuum off any dust. Keep the massage chair clean and away from damp places.

### Caution

- ▶ Do not store the product in direct sunlight or in places with high temperature. This may cause the color of the upholstery to fade.

### 3.Synthetic Leather and lining

- ▶ Please use a soft and dry cloth to clean the machine.
- ▶ Every two or three months, polish the lining with a clean cloth that has been moistened with a cleaning agent, and then clean it with a dry and soft cloth after it dried.



## NAME AND FUNCTION OF EACH COMPONENT

### External structure

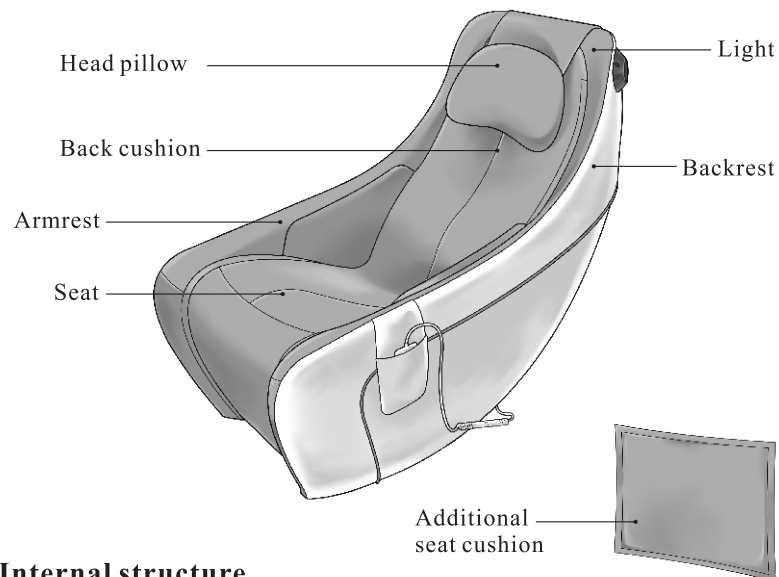

### Internal structure

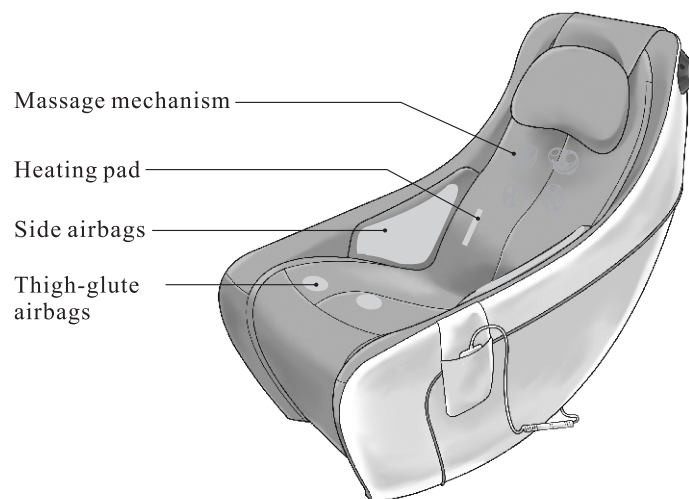

## INSTALLATION

### Installation method

(We recommend you don't move the chair by yourself and ask someone for assistance.)

#### Step 1:

- ▶ Unpack the carton, carefully get out massage chair and all accessories.
- ▶ Turn the supporting stand over backwards (support stand locates at bottom of the massage chair)

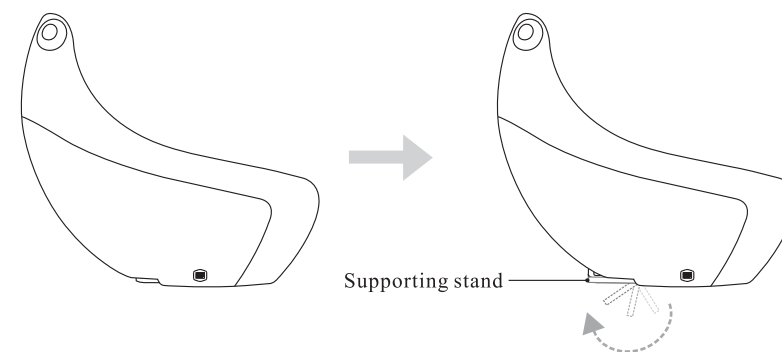

#### Step 2: accessories

- ▶ Plug the power cord into the chair and turn on the power switch and start the massage chair with remote controller.

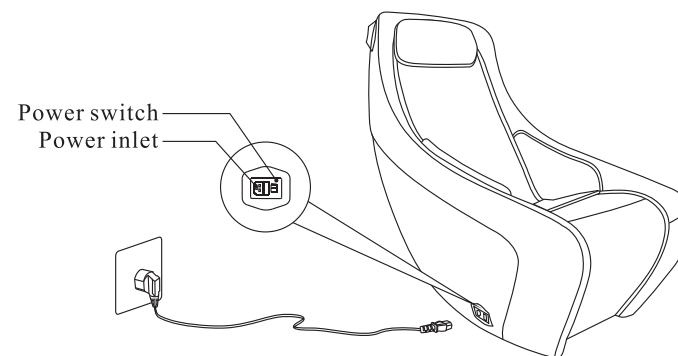

### ⚠ Caution

- ▶ Before using, please ensure none of the cables are tangled.

## INSTALLATION

### Installation position

Ensure there is a safe distance in front of and behind the massage chair.  
 Back: minimum 4in (10cm) from the wall or any other obstacles;  
 Front: minimum 8in(20cm) in front of the chair or any obstacles;  
 In order to prevent signal interference, please keep at least 40in (1 m) away from the TV, radio or other video or audio devices.

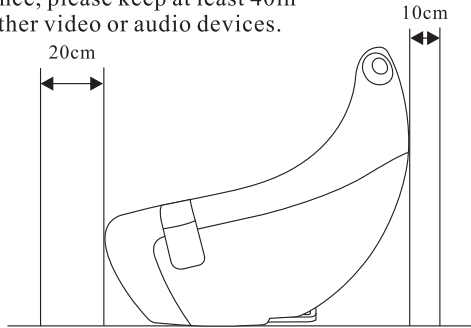

### Floor protection

► Please put carpet or another pad under the massage chair, in order to ensure a level surface.

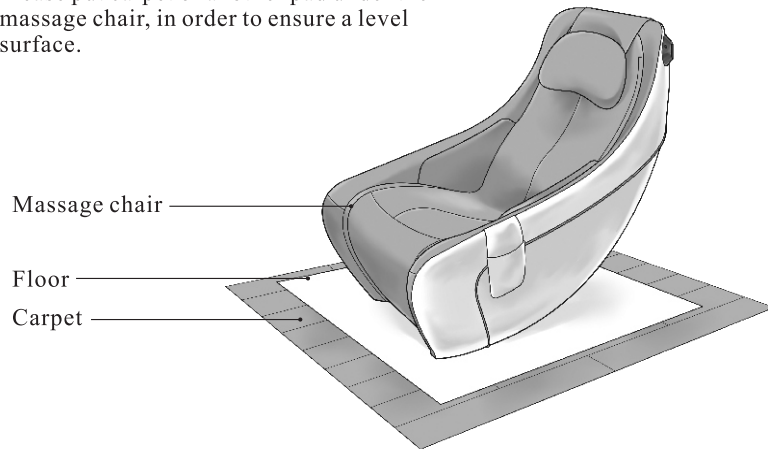

### Surrounding environment



Keep the massage chair away from damp places (for example: bathroom) to avoid electrical hazards.



Keep the massage chair away from high temperatures (for example: stove) to avoid fire or damage to the synthetic leather material.

## NAME AND FUNCTION OF EACH COMPONENT

### Controller

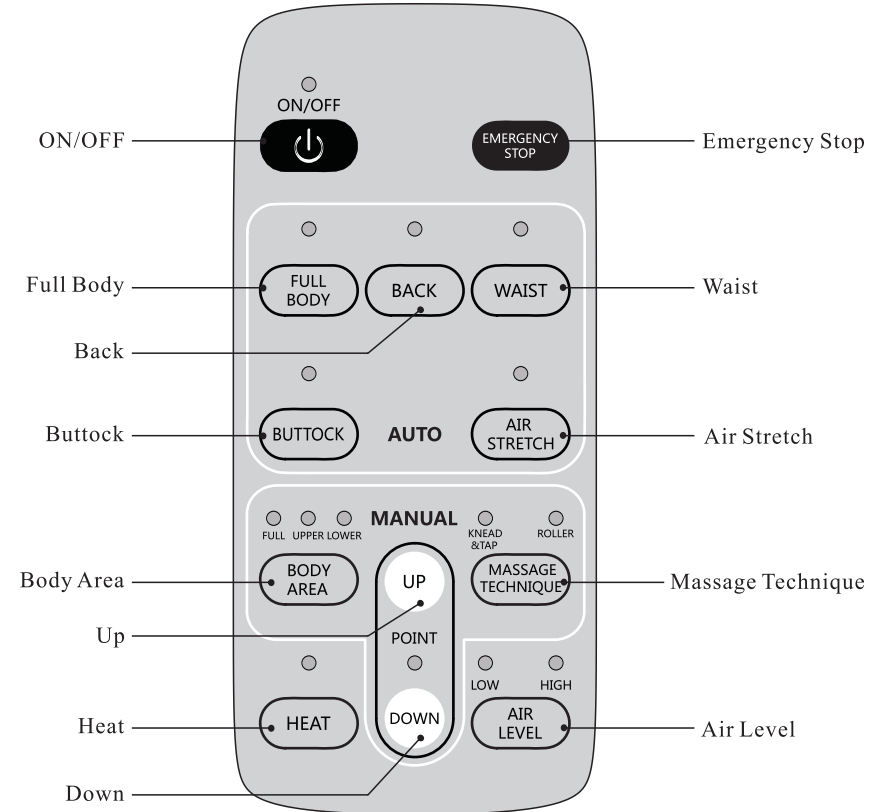

## NAME AND FUNCTION OF EACH COMPONENT

### How to use the Controller



#### ON/OFF

- ▶ When power is on, push the “ON/OFF” button to power on the chair, the light will stay on to let you know its on, choose any program from AUTO or MANUAL to start the massage. Push the button again to turn off the massage, (the rated time is 15 minutes) (If you didn't choose any program after pushing the ON/OFF button within 30 seconds, it will automatically turn off.)



#### Emergency Stop

- ▶ At any time, push the “EMERGENCY STOP” button to stop all function, push button “ON/OFF” to restart the massage.



#### Full Body

- ▶ When powered on, push the “FULLBODY” button to start the automatic course for your full body.



#### Back

- ▶ When powered on, push the “BACK” button to start the automatic course focusing on your back part.



#### Waist

- ▶ When powered on, push the “WAIST” button to start the automatic course targeting your waist region.



#### Buttock

- ▶ When powered on, push the “BUTTOCK” button to start the automatic course focusing on your glutes and thighs.



#### Air Stretch

- ▶ When powered on, push the “AIR STRETCH” button to start the automatic course air pressure course.



#### Body Area

- ▶ During AUTO massage mode push the “BODYAREA” button to change to the manual massage mode, and switch massage positions among FULL, UPPER, LOWER.
- ▶ During MANUAL massage mode, push the “BODY AREA” button to switch the massage position among FULL,UPPER,LOWER.

## NAME AND FUNCTION OF EACH COMPONENT



#### Message Technique

- ▶ During AUTO message mode, push the MESSAGE TECHNIQUE button to change to MANUAL message mode, and switch massage techniques between KNEAD&TAP and ROLLER.

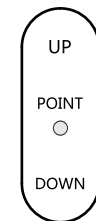

#### Up:

- ▶ During any message mode, push the UP button to switch to POINT message mode, hold the button to move the mechanism up. It only performs KNEAD&TAP massage under POINT mode.

#### Down:

- ▶ During any message mode, push the DOWN button to switch to POINT message mode, hold the button to move down the mechanism. It only performs KNEAD&TAP massage under POINT mode.



#### Heat

- ▶ During any message mode, push the “HEAT” button to switch the heating function on/off..



#### Air Level

- ▶ During any message modes except “AIRSTRETCH” ,push the button “AIR LEVEL” to switch among the "LOW" and “HIGH” level, turn off the air pressure function, or turn on the air pressure function.
- ▶ During message mode “AIR STRETCH” , push the “AIR LEVEL” button to adjust the level “LOW” or “HIGH” .