

DR.FUJI[®]

Cyber-Relax[®]

FJ-8000

USER MANUAL

DR.FUJI

FUJIIRYŌKI USA/DR.FUJI/ACIGI RELAXATION

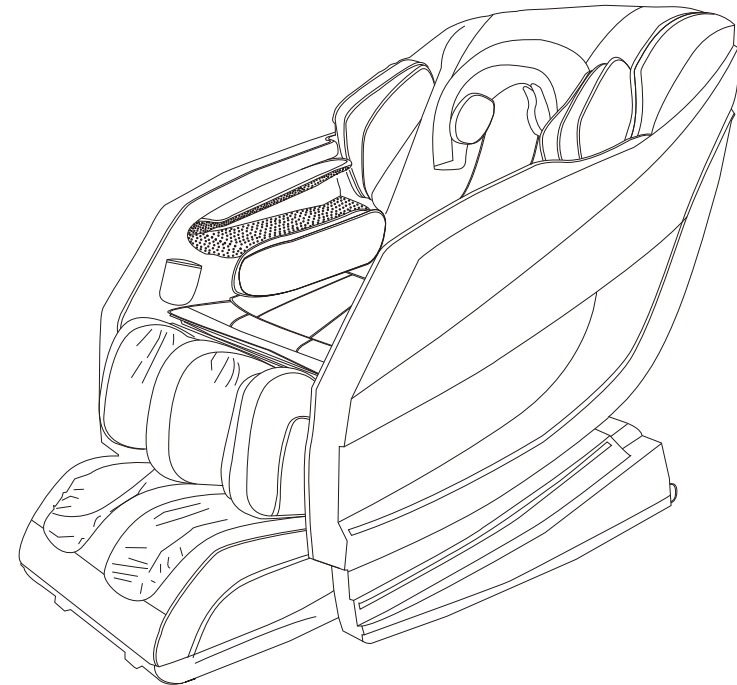

” IMPORTANT SAFETY INSTRUCTIONS ”

Please read this operating instruction carefully before operating the chair.
Please keep this manual in a good place for future reference after reading.

www.fujiiryokiusa.com
www.drfuji.com
1-888-816-0888
HEAD OFFICE: 4399 INGOT STREET
FREMONT, CA 94538, USA

ACIGI RELAXATION

Contents

Congratulations on purchasing this massage chair. Please read and follow all safety and operating instructions listed in this user manual prior to use. Basic precautions should always be used when operating an electrical appliance.

Note:

We reserve the right to make changes to information published in this document, including without limitation specifications and product descriptions, at any time and without notice. This document supersedes and replaces all information supplied prior to the publication here of.

Pre-work	Safety precaution	01
	Parts name	04

Installation	Methods of installation	05
--------------	-------------------------------	----

Usage and maintenance	Pre-work before massage	13
	Features	14
	Bluetooth and APP	15

Others	Trouble shooting	23
	Specifications	24

Safety Precaution

IMPORTANT SAFETY INSTRUCTIONS

Please read and follow the instructions given below. Failure to comply may result in the risk of burns, fire, electric shock, or injury to persons. Please use a compatible electric outlet to power your massage chair.

WARNING:

1. Any individuals who is pregnant, has a pacemaker, suffers from diabetes, phlebitis, and/or thrombosis or is at an increased risk of developing blood clots due to recent surgery should consult his/her physician before using a massaging massaging device or appliance designed for home use.
2. The massage experience should be pleasant and comfortable. Should pain or discomfort occur, discontinue use and consult your physician.
3. Do not use while sleeping or if you feel drowsy.
4. Never use with swollen or inflamed skin, or if skin eruptions or open wounds are present.

This unit has a hot surface. Those who are sensitive to heat must be careful when operating

SAFETY INSTRUCTIONS

1. Always unplug this appliance from the electrical outlet after use, before cleaning, before installing or removing parts.
2. Do not cover appliance with blankets or other items. Excessive heating can occur and cause fire, electric shock, or injury to persons.
3. Close supervision is necessary when the appliance is used by or near children, disabled persons, or pets. The product is not intended for use by children or persons with reduced physical, sensory or mental capabilities, or lack of experience and knowledge, unless they have been given supervision or instruction on using the appliance by a care giver.
4. Use this appliance only for its intended use as described in this manual. Do not use attachments not recommended by the manufacturer.
5. Please do not use replacement parts from an unauthorized dealer or service provider.
6. Never operate this appliance if it has a damaged cord or plug, if it is not working properly, if it has been damaged, or has come in contact with water. Return the appliance to the manufacturer for examination and repair.
7. Do not unplug the appliance by pulling on the power cord. To disconnect, turn power switch to off position, then remove plug from the outlet. Please do not use wet hands to unplug.
8. Keep the cord away from heated surfaces.
9. Never operate the appliance with the air openings blocked. Keep the air openings free of lint, hair, or other objects.
10. Never drop or insert any object into any opening.
11. Do not use outdoors.
12. Do not operate where aerosol spray products are being used or where oxygen is being administered.
13. Do not stand on or in the appliance. Please do not stand in, climb on, jump on, or sit on the leg rest portion of the massage chair. Use only while seated.
14. Please do not sit on the armrest or the backrest part of the massage chair. The machine may tip and cause bodily harm if excessive weight is applied.

Safety Precaution

15. Temperatures sufficiently high to cause burns may occur regardless of the control setting. Do not use heating function on children or persons with reduced physical, sensory or mental capabilities. Do not use heating function on a sleeping or unconscious person. Check skin in contact with the heated surfaces of the appliance frequently to reduce the risk of burns or blisters.

16. Move massage chair only when necessary and always handle with care when moving the backrest and leg rest to prevent damages.

17. Never remove backrest coverings and cushions. Examine the textile coverings and cushions prior to each use. If surface shows any sign of deterioration, such as cracking, peeling, blistering or fraying fabric, please refrain from use and contact customer service.

18. If power outage occurs in the middle of use, please switch the power switch to OFF, and unplug the machine to prevent power surge when electricity returns.

19. Please do not fall asleep during the massage, as reflexes and senses are diminished when unconscious, and may result in bodily harm.

20. Please use tremendous care when adjusting the backrest and leg rest reclining positions, and do not adjust positions when children or pets are near, under, or behind the machine.

Usage Environment Requirements

1. Please do not use machine in a high humidity or dusty environment to reduce the risk of malfunction or electric shock.
2. Please do not place machine in area of direct sunlight or near heat sources. DO not use when temperature of room exceeds 104° F.
3. Please use massage chair in an uncluttered environment with at least two feet of space around the machine.
4. Place and use massage chair on flat, even, non-slip flooring.
5. The massage chair is intended for personal use in a residential setting, and may not be used for commercial purposes.
6. If room is excessively cold or hot, please adjust the temperature gradually and not abruptly. If the massage chair has been stored in a cold area and is moved into a warm area, please wait one hour before use. Condensation may occur as a result and may cause malfunction.

Safety Precautions

1. Do not use massage chair in combination with other therapeutic appliances as this may result in ineffectiveness or injury.
2. Do not use massage chair for one hour prior or after dining.
3. Do not use appliance when your hands or body are wet.
4. Do not perform fixed position massage on one spot of your body for more than 5. minutes at one time as this may result in excessive stimulation and may cause negative effects.
5. Do not insert your hand or foot along the paths of the massage rollers during use
6. Stop immediately if you experience any discomfort.
7. Do not use when under the influence of prescription drugs, alcohol, or substances
8. Do not apply massage rollers directly on the head, elbow, joints, or abdomen
9. The massage chair is not intended for self-treatment of medical conditions that should be treated by a qualified healthcare provider.
10. Please consult physician prior to use if you are on medication, have medical conditions, or are not sure whether the massage chair is suitable for you.

Safety Precaution

Medical Conditions

Please consult your physician prior to use if you:

- ◆ Are under medical rest.
- ◆ Have spinal disorders, an abnormal spinal condition or have suffered a spinal injury.
- ◆ Have excessive back pain and severe back conditions.
- ◆ Have diabetes, osteoporosis or sensory impairment.
- ◆ Have malignant tumor.
- ◆ Have joint dysfunction such as rheumatism, hammer toe or gout.
- ◆ Have a pacemaker or other electronic/mechanical medical devices in your body.
- ◆ May be pregnant.
- ◆ Have phlebitis or thrombosis.
- ◆ Have an increased risk for blood clots.
- ◆ Recently had surgery.
- ◆ Have surgical pins, screws, or mechanical components in your body.
- ◆ Are undergoing chemical treatment.

CAUTION

Please switch off the main power switch immediately and disconnect the power cord from the electrical outlet if:

- ◆ Water is spilled onto the massage chair.
- ◆ Pain or discomfort during massage is experienced.
- ◆ Fabric or cushion is torn and internal components are exposed.
- ◆ Abnormal sounds or motions occur during the massage.

REPAIR

Do not remove the plastic back cover of the massage chair. Mishandling of the internal components may result in malfunction or injury.

Do not attempt to service or repair the chair. Work must only be performed by professional and authorized service technicians.

GROUNDING INSTRUCTION

This product must be grounded. In the event of an electric short-circuit, grounding reduces the risk of electric shock by providing a path of low resistance for the electric current. This product is equipped with a cord having a grounding wire with a grounding plug. The plug must be plugged into an outlet that is properly installed and grounded in compliance with all local codes and ordinances.

DANGER

Improper use of the grounding plug may result in a risk of electric shock. Check with a qualified electrician if you are in doubt as to whether the product is properly grounded. Do not modify the plug provided with the product- if it will not fit the outlet, have a proper outlet installed by a qualified electrician.

Name Of Each Component

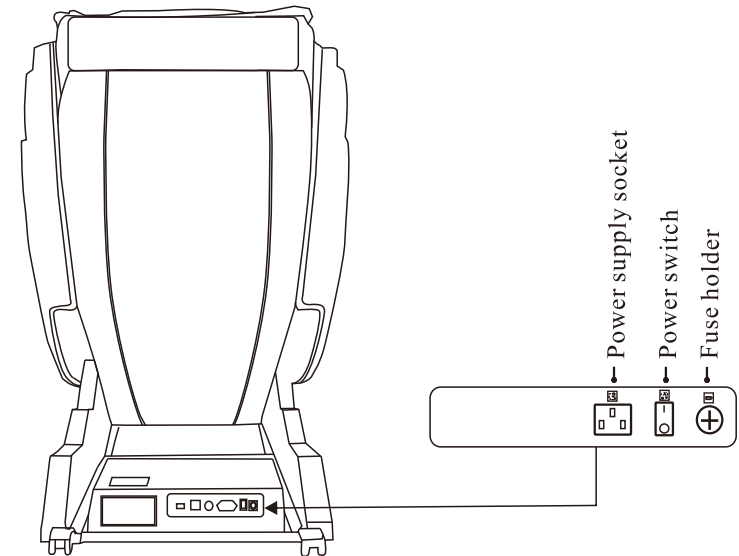
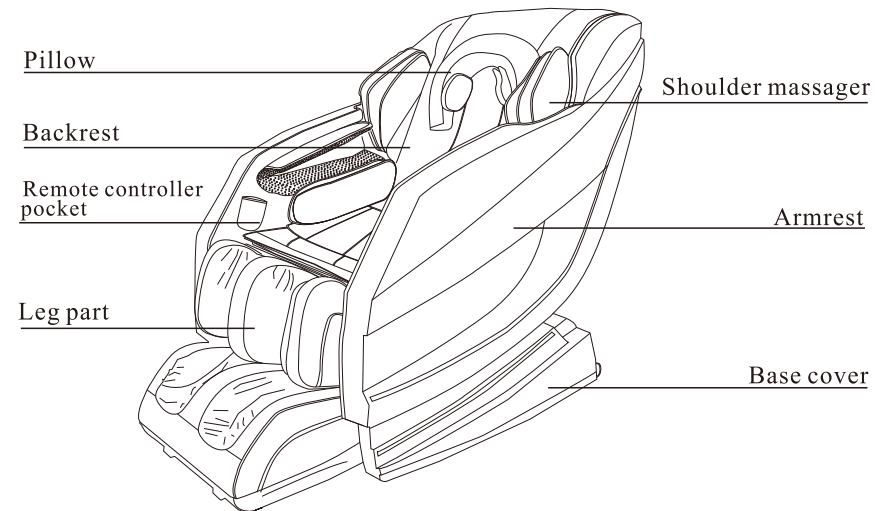

Method of installation

Installation(1)

Step1 Unpack the main body box.
Carry out the main body, leg part and accessory box, when carrying out the main body, we suggest at least two people to help.



Main body



Leg part



Pillow



Accessory box

Step2: Unpack the armrest box
Take out the armrest and base cover.



Armrest(Right)



Armrest(Left)

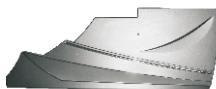

Base cover(Right)

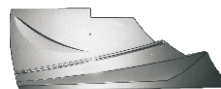

Base cover(LEFT)

Step3: Reset the main body
Connect the power cord, and remote controller, turn on the switch on the lower back, press the power buttons twice, waiting for about 30 seconds, the main body will go back to the reset position.



Original position



Reset position

Method of installation

Installation(2)

Step4: Install the wheels



Insert the wheels into the iron tube which is on the lower back of the main body.



Fix it with screws

Method of installation

Installation(3)

Step5: Install the lining iron of the leg part

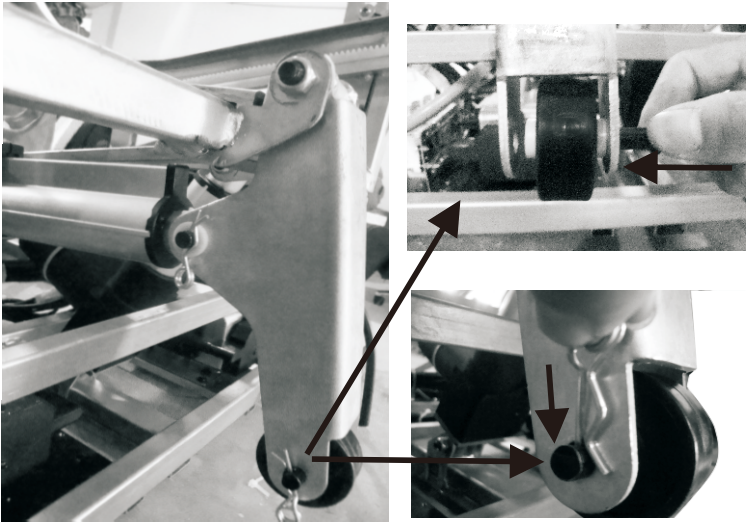

Fix the front part of the iron with dowels push rod with dowels in the same way. C frame than fix it with screws.

Step6: Connect the leg part

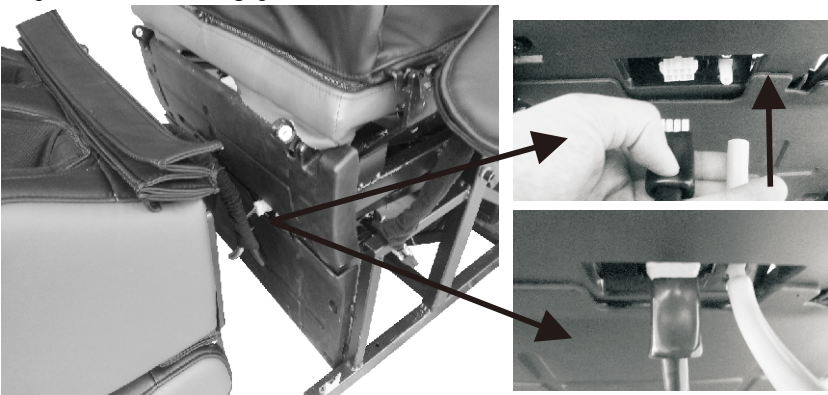

Connect the power cord and air hose to the main body

Method of installation

Installation(4)

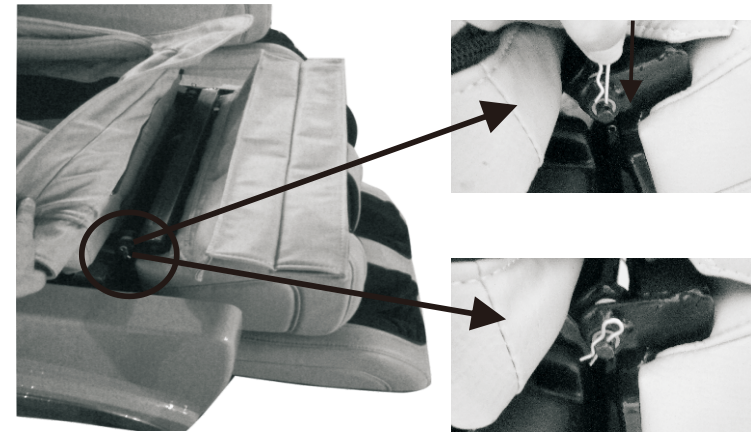

Hung the leg part to the leg part adapter of main body, fix it with pins and locker.

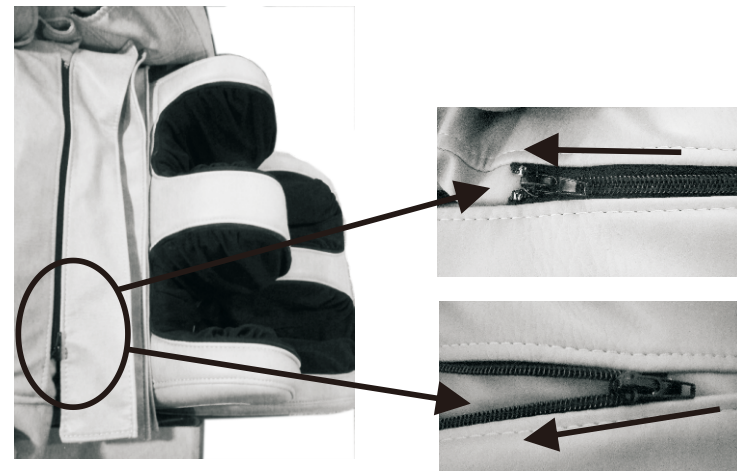

Zip up the leather case of between the leg part and cushion.

Method of installation

Installation(5)

Step7:Install the base cover

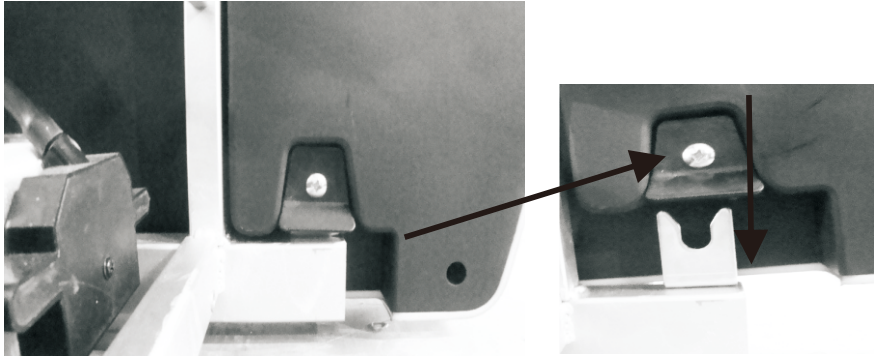

Insert the bottom of the base cover to the connector on the base frame of the main body from top to bottom. (Notes:The whole base cover as below)

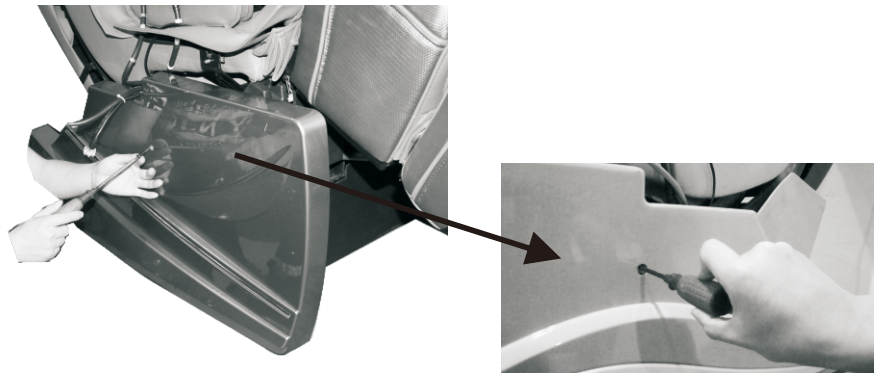

Fix it with screws

Method of installation

Installation(6)

Step8: Install armrest

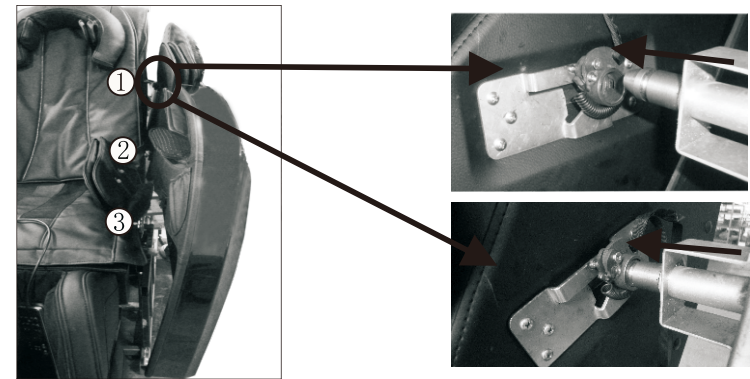

Lift the front part, then aim the side parts card at the fixed axis of the main body(as part1 in the picture).Pull the spring hook and push inward hardly to fix absolutely.

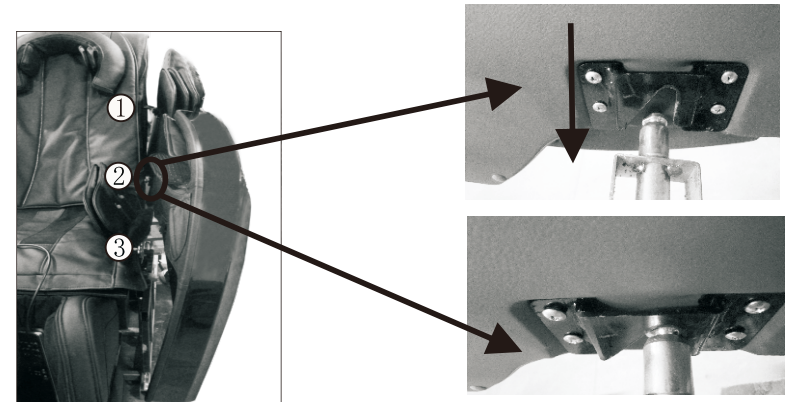

Set the armrest closely to the main body(as picture2).Insert the parts card into intermediate shaft of the main body from the top to the bottom slowly.

Method of installation

Installation(7)

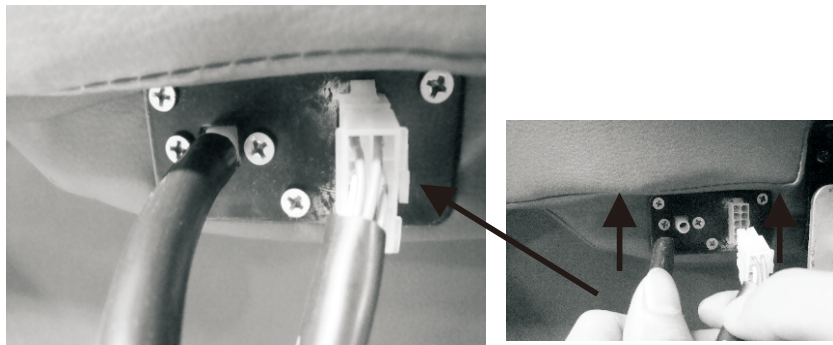

Connect the air hose and power cord to the main body.

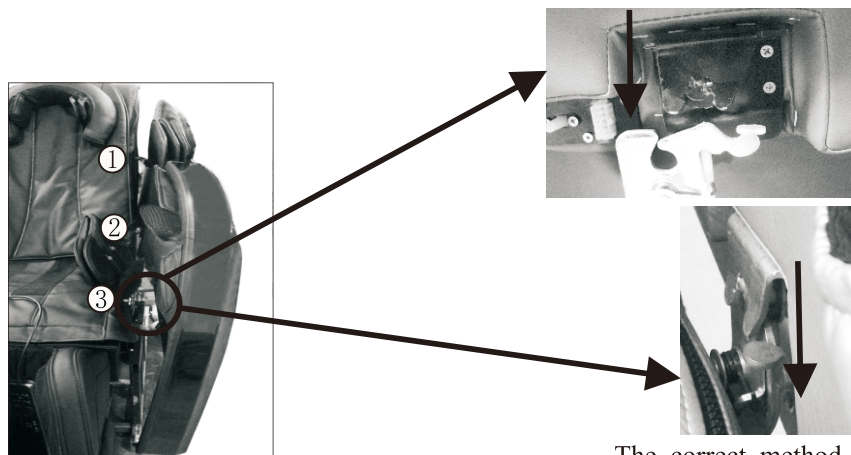

The correct method

Finally, insert the fixed block (as picture 3) into the fixed axis of the main body from the top to the bottom.



The fault method

Method of installation

Installation(8)

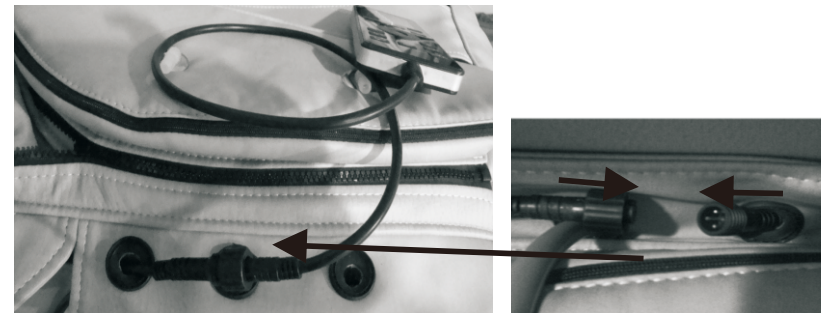

Connect the connecting line of the remote controller to the main body.

Step9: Install the back cushion

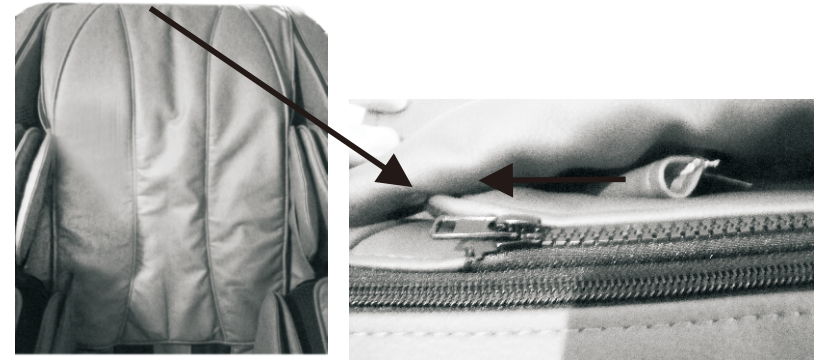

Lay the back cushion flat on the main body (as the above picture), then close the zipper at the top.

Installation instruction

Space needed

Make sure there is 10 cm space from the back to the wall or other obstacle, and 25 Cm from the front.

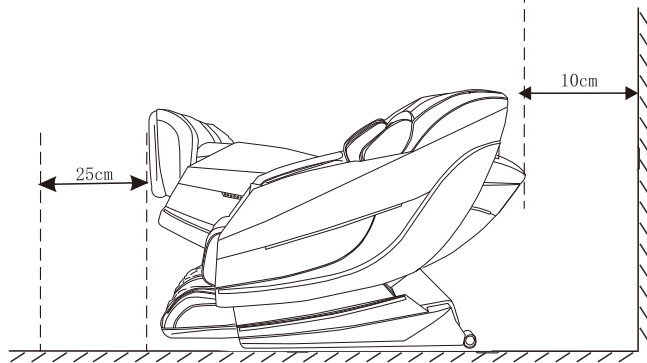

Before using, make sure the power cord is not knotted, entangled with other stuff or crushed under the main body; when the chair is reclining/lifting, make sure there is no kids, pets or other stuff around in the front/back part of the chair; to protect the floor, you can put a blanket under the massage chair.

Method of moving

The chair can be easily moved with the wheels on the lower back. While moving, please raise the front part of the chair as the picture shows, and move the chair to any suitable place.

Tips:

- 1 Remove the power cord and controller cord before moving.
2. If need to cross-a narrow door, we suggest to remove the armrest first.
3. If the floor is easily scratched, don't use the wheels to move the chair, lift it up by at least 4 people, and move it.

⚠ Attention

Do not move the chair while there is someone sitting on it.

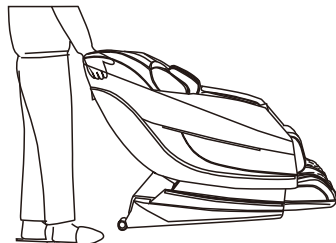

Confirm and adjust before usage

New features

Zero gravity: By adjusting the angle of the backrest, seat and leg part, the chair can offer a zero gravity position, which makes the massage more powerful and maximum the relaxation.

Foot roller: Equipped with 3 rows of rollers, cover the whole sole, offer real Thai scrapping massage.

Thai-style foot scrape therapy massage: 3 rows of foot rollers can offer you an artificial human scrape therapy massage from the heel to the toes.

Full air pressure armrest massager: Offer an air pressure arm massage according to 18 groups of built-in massage acupuncture points to promote blood circulation. Leg part extending function: The leg part can automatically stretch and contract according to the individual height and length of the legs.

Carbon fiber far-infrared heating: Heat the waist, buttocks & legs & heels by 50°C simultaneously. It can relieve your cold and pain to promote metabolism.

L-shape back track: Industry-leading "L" shape back track can make the massage more comfortable and perfect by the outstanding shoulder and waist track massage.

Pillow massage: The U-shape pillow can massage your temple accurately to relieve your fatigue to lead a perfect effect.

Bluetooth connection: Equipped with Bluetooth module, the chair can be connected to smart device, and can be operated and play music by smart device. (Android system and Apple IOS system)

Sliding Function: The top backrest forward sliding function can replace the old concept of backlying down function. It only needs about 10cm space from the chair to the wall. It is more convenient to place the chair in room which can save the space fully.

Calf rolling massage function: The latest rolling function and the wrapping air pressure massage function on the calf part can estimate the muscle of the calf part deeply.

Replace the fuse

When the fuse is burned-out, please remove the power plug first, turn off the switch, use a screw driver to open the fuse holder.

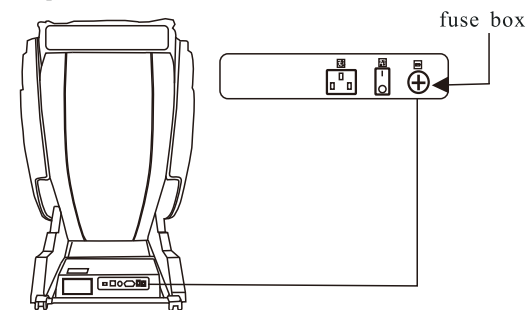

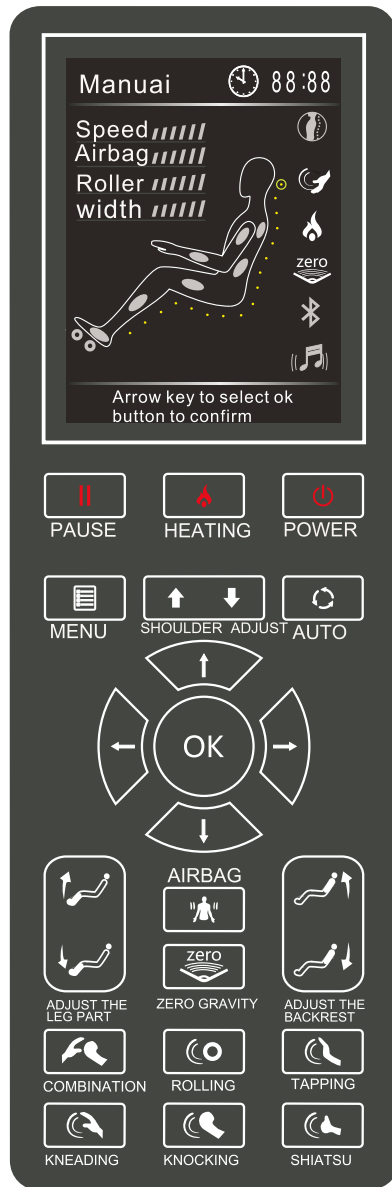

Remote controller instruction



Remote controller instruction

Instruction of the buttons

- 
Power: On/off key of the whole chair.
 - ▶ Press this key, the chair will start to work (default massage time is 20 minutes),
 - ▶ press it again, the chair will shut down and go back to the reset position.

- 
Pause
 - ▶ When the chair is working, press this key, all actions will be suspended, press it again, all the actions will recover.

- 
Menu
 - ▶ You can choose programs, massage methods, setting functions by pressing this key.

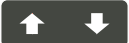
- 
Shoulder position adjustment
 - ▶ Adjust the height according to different people

- 
Full body program switch
 - ▶ Press this key to choose and switch full body program, this chair has equipped 4 full body program, they are Chinese massage, American massage, Thai massage, and Hong-Kong massage.

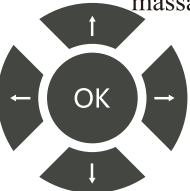
- 
Direction key
 - ▶ Up/down key: Press the key to adjust the menu and the roller position when it is at the focus function.
 - ▶ Right/left key: Press this key to adjust the leg part extending position.

- 
Zero gravity Key
 - ▶ Press this key to enter zero gravity position, the zero gravity icon on the display will be light up, and will turn off when you adjusting the backrest/leg part angle by manual, which will make the chair out of Zero gravity position.

- 
Lifting up the leg part
 - ▶ By long press this key, the leg part will lifted up.

- 
Lifting down the leg part
 - ▶ By long press this key, the leg part will lifted down.

Remote controller instruction



Lifting up the backrest
By long press this key, the backrest will lifted up



Lifting down the backrest
By long press this key, the backrest will lifted down.



Air bag key
▶ Turn on/off the air bag massage system by press this key



Heating key
▶ Press this key, the heating system will turned on, and the heating icon on the display will be light up, press it again the heating system will turned off, and the icon turn into grey.

Icon and Menu

▶ Auto program

In the auto program menu, there are four full body program, an upper body program and a lower body program.

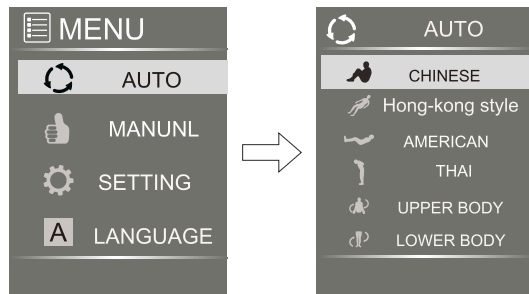

Hong-Kong massage: Regular position massage, for those who prefer a more gentle massage.

Chinese massage: Stretch function, for those who sitting for a long time.

Thai style massage: The massage position changes every 3 minutes, for those who need a deep massage.

American massage: The chair will works like a rocking chair, help the user to get a better rest

Upper/lower body massage: Partial body massage program.

Remote controller instruction

▶ Manual mode

Click the “Menu” button, then choose the “Manual” to start manual program.

Use up/down key to choose, OK to confirm.

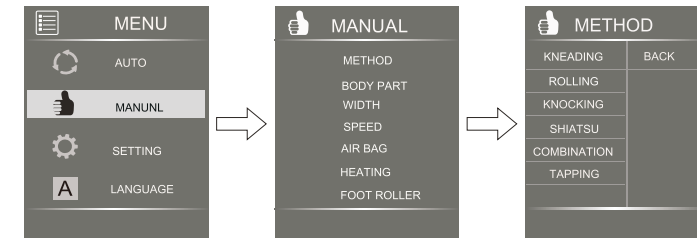

Message method: In this subdirectory, you can use up/down key to choose. There are six massage method: Kneading, Tapping, Knocking, Shiatsu, Rolling, Combination.

Part: This subdirectory is for back roller massage range, us up/down to choose. Offer 3 options: Full, partial, focus.

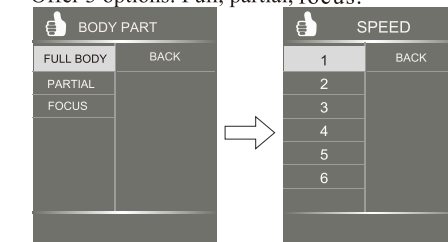

Width: This subdirectory is for adjusting the massage width of the back rollers. Offer wide, middle, narrow for option.

Speed: This subdirectory is for adjusting the massage speed of the back rollers. Offer 6 degree for option.

▶ Air bag: This subdirectory is for managing the air bag system, contains part and intensity option.

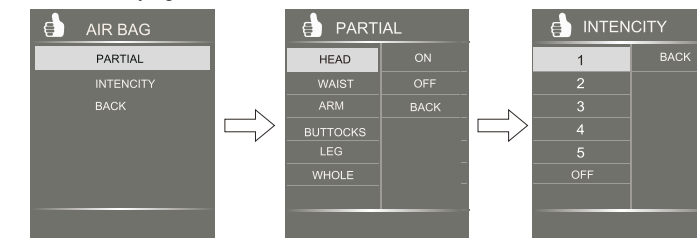

Part: In this Subdirectory, you can turn on/off some air bags by choose it and select the off/on button.

Intensity: This is for adjusting the air pressure intensity, offer 5 degree for option.

Remote controller instruction

► Foot roller

Choose roller, in the subdirectory, you can adjust the roller speed, offer 3 grade for option.

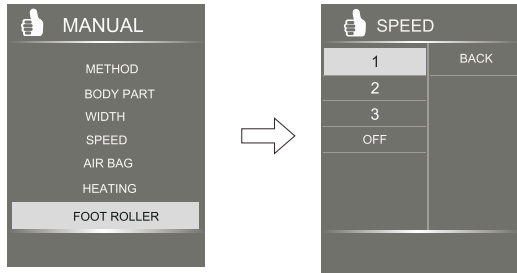

► Setting

Press "Menu" key, choose "Setting", enter the subdirectory

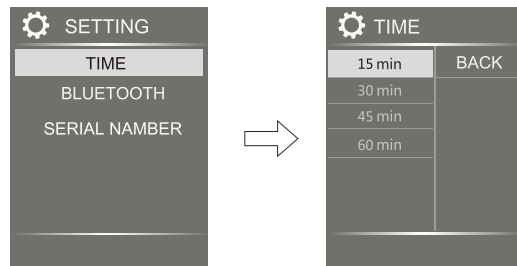

Time: Setting worktime, offer 10 minutes, 20 minutes, 30 minutes, 60 minutes for option.

Bluetooth: Turning on/off the Bluetooth module. By default, it is turn off

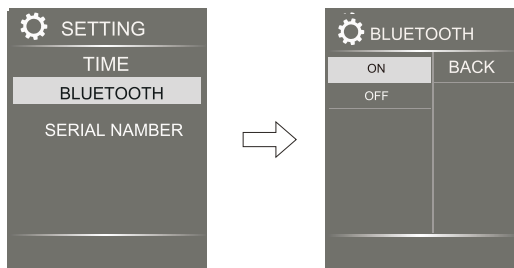

Remote controller instruction

Tips:

1. Under auto/manual mode, the display will switch to the home page after 10 seconds without any operation.



Home page while under manual mode



Home page while under manual mode

😊 Tips:

- During working, press "Menu" twice, it will go back to the home page immediately.
- In the home page, under manual/auto program, press shoulder position key to adjust the highest position of the back rollers.
- Press "auto" key to choose auto program.

2. Before running auto program, it will inspect shoulder position first. After the inspection, it will switch to the auto program.

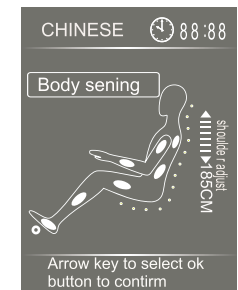

Memory Mode

New program has memory function, it will record airbag intensity, foot roller speed, set time etc. as the parameters of next time.

Remote controller instruction

Display Music

This chair allows you to display music on it via any Bluetooth enabled device. Please turn on the Bluetooth of your device, and connected with the device named "Massager", then the audio system of the chair will be able to work.



The message chair can be easily operated via a Bluetooth enabled Android or ios device. Please Scan the QR code listed below to install a remote APP first.



iOS



Android

For IOS users, user can search "Message Chair Remote" at APP store.

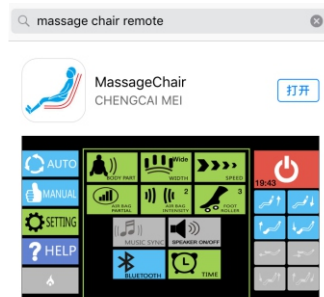

Bluetooth and APP

App Operating Guide

Now that you've installed the remote app, and your device has connected to the message chair successfully, the chair is almost available for wireless operation. All you need to do is open the app, and press the Bluetooth icon on the home screen, and connect to the "massager" device again, after the connection being settled, the color of the power button will turn from grey to red, press it, the chair will start to work and you can also adjust the chair through other buttons.

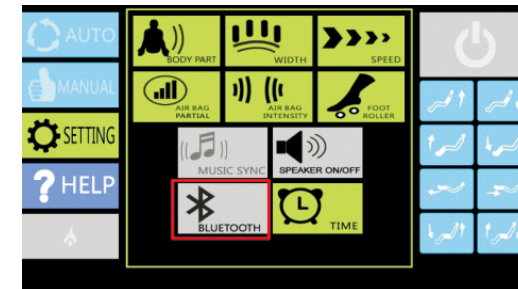

Press the bluetooth button

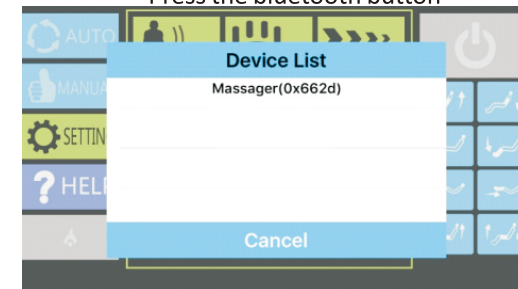

Connect with the "Massager" again

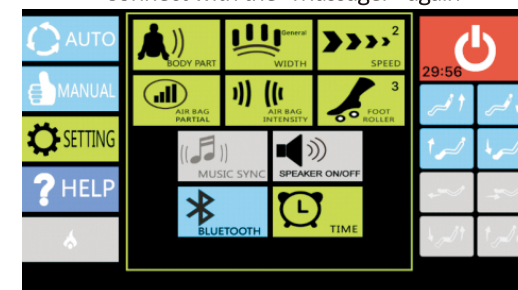

The chair is ready for operation when the power button turns red

Troubleshooting

Failure	Possible cause	Processing method
Can not work after supplied power	Didn't turn on the power switch	Turn on the switch
	Didn't choose massage program	Choose a massage program
	Bad connection between plug and socket	Connect again
	Power cord or plug damaged	Replace the power cord
	The fuse burned up	Replace the fuse
	A fault in the controlling circuit	Contact with the maintenance department of supplier
Working with tap-tap-tap or hum sounds	Sounds from air pump, motor or other mechanical parts	Normal phenomenon
Different hight for the massage rollers	Rollers under alternately work	Normal phenomenon
Abnormal sounds suddenly occurred while working	If after long time works	Cut down the power and check after 30 minutes
	Cause from long time work	Contact with the maintenance worker
Suddenly stopped working	If after long time works	Supply power again
	Auto programmed time is up	Cut down the power and use after 30 minutes
Can not recline	Obstructor there; work overloaded automatically stopped work for protecting machine	To move the obstructor; stop work and use after 30 minutes
Can not restore after relined	Problem on electromotion pole or plug-ing under bad connection	Contact with the maintenance worker
Control panel overheat seriously	Cause from long time work	Cut down the power and call the maintenance worker
Abnormal overheat from power wire and plug	Work overloadingly	Cut down the power and use after 30 minutes
	Causes from other reasons	Cut down the power and call the maintenance worker



If problems all are not from above reasons, please stop power supply and contact with the distributor or factory for maintenance.

Specifications

Model	FJ-8000
Performance parameter	
Massage Stroke Length(in)	51.2
Rollers Space Between(in)	1.3-7.1
Tap(cpm)	200-600
Pummel (cpm)	100-450
Knead&Tap(cpm)	10-90
Shiatsu (cpm)	180
Knead (cpm)	25-100
Calfrest Recline Angle(°)	0-100
Backrest Recline Angle(°)	128-160
Calfrest stretch Length (in)	0-9.8

Model	FJ-8000
Technical Spec	
Dimension of main box. (in)	L59.8*W26.8*H34.3
Dimension of armrest box.(in)	L66*W21.3*H28.7
Dimension of the leg structure(in)	L23.6*W21.3*H21.7
Net weight of main box.(lb)	178.6
Gross weight of main box.(lb)	216.1
Net weight of armrest(lb)	60
Gross weight of armrest(lb)	103.6
Net weight of leg structure(lb)	51.8
Gross weight of leg structure(lb)	61.7

Model	FJ-8000
Specifications	
Rated Voltage	AC100-120V AC200-240V
Rated Frequency	50-60Hz
Power Consumption	220V
Safety Standards	Type 1