



PROTEK MANUFACTURING CORP.
High Performance Fire Fighting Equipment



FEATURE PRODUCTS

For high performance fire fighting equipment, visit www.protektfire.com.tw



Style 366-F
Low Pressure Selectable Gallonage Nozzle
(See page 23)



Style 620
Dual-Purpose Ground Monitor
(See page 66)



Style 660
Industrial Monitor
(See page 63)



Style 366E-BC
Selectable Gallonage Foam Nozzle
(See page 29)



Style 326
Multi-Mode Nozzle
(See page 11)



Style 837-BC
Constant Gallonage Monitor Nozzle
(See page 52)

For high performance fire fighting equipment, visit www.protektfire.com.tw



IRCS

Integrated Remote Control System
(see page 76)



Style 325

Multi-Mode Nozzle
(See page 11)



Style 355

Low Pressure Selectable Gallonage Nozzle
(See page 24)



Style 661

Industrial Monitor
(See page 63)



Style 542

Multi-Purpose Wye
(See page 82)



Style 372-F

Low Pressure Constant Gallonage Nozzle
(See page 23)

PROTEK MANUFACTURING CORP.

About Protek

Protek Manufacturing Corp. is a leader in providing high performance fire fighting equipment. Since 1972, Protek has adhered to three operating principles of delivering high-quality products, creating value for our customers and providing exceptional service.

Headquartered in Taichung, Taiwan, Protek has established manufacturing capability and management to deliver quality, value and service to all our customers. From employing new technologies to testing each and every product before shipment, Protek takes pride in its products as customers worldwide can attest.

Protek is constantly improving existing products and developing new products in order to meet the challenges of the fire industry. From new-generation multi-mode nozzles to wireless remote controlled monitors, we have continually developed products that are tailored to the evolving needs of our customers.

Protek is committed to delivering products of the highest quality and value for our customers, exceptional service and effective manufacturing processes. Protek strives to exceed customers' expectations at all times and continue its position as an industry leader.

Quality and Certifications

Protek is proud to be ISO 9001:2008 registered with the internationally recognised Underwriter Laboratories Inc. (UL). This accomplishment reflects our relentless dedication to quality in our products, excellence in our manufacturing processes and service for our customers.

Protek has received FM approvals for a wide range of our nozzles and monitors. Recognised and respected across the globe, the FM approvals are a testament that our products have been objectively tested and conform to the highest standards. In addition, Protek has received US Coast Guard approval for selected marine nozzles.

Protek is committed to ensure NFPA 1964 compliance. All of Protek nozzles are designed and tested to comply with NFPA 1964. In addition, we are EN 15182-2 Type 3 and DIN 14367 compliant across our selected range of handline nozzles.

As part of Protek's focus on quality, we are continually assessing our products and renewing our certifications.



Customer Sales: sales@protektfire.com.tw

Customer Service: support@protektfire.com.tw

Technical Support: technical@protektfire.com.tw

Visit our official worldwide website!

www.protektfire.com.tw

TABLE OF CONTENTS

HANDLINE NOZZLES

Selectable Gallonage Nozzles	2-7
EN Selectable Gallonage Nozzles	8-9
Multi-Mode Nozzles	10-11
Multi-Purpose Nozzles	12-13
Automatic Nozzles	14-17
Constant Gallonage Nozzles	18-21
Low Pressure Nozzles	22-24
High Pressure Nozzles	25-26
Shockless Nozzles	27
Retractable Foam Nozzles	28-30
Self-Educting Handline Nozzles	31-32
Dual-Flow Foam Nozzle	32
Dual-Agent Nozzle	33
Dry Chemical Nozzle	33
Foam Aeration Tubes	34
Ball Shutoffs & Playpipes	35-36
Smooth Bore Tips	37
Shutoff with Tips	38
Nozzle Accessories	39
Optional Nozzle Base & Teeth	40
Pistol Grips & Handles	40

SPECIALTY NOZZLES

Wildland/Forestry Nozzles	41
Marine Nozzles	42-43
Flashover Nozzle	44
Electric Nozzle	44
Deicing Nozzle	44
Piercing Applicators	45
Industrial Fog Nozzle	45

MONITOR NOZZLES

Selectable Gallonage Monitor Nozzles	46-47
Adjustable Flow-Baffle Monitor Nozzles	48-50
Automatic Monitor Nozzles	51
Constant Gallonage Monitor Nozzles	52
Electric Monitor Nozzles	53
Self-Educting Monitor Nozzles	54-56
Monitor Nozzle Accessories	56

MONITORS

Industrial Ground Monitors	57-63
Portable Ground Monitors	64
Dual-Purpose Ground Monitors	65-67
Portable Oscillating Ground Monitors	68
Monitor Accessories	69-70
Remote Control Monitor	71-72
Wireless Remote Control Monitors	73-75
Integrated Remote Control System	76-78

FOAM EQUIPMENT

Retractable Foam Nozzles	28-30
Self-Educting Handline Nozzles	31-32
Dual-Flow Foam Nozzle	32
Dual-Agent Nozzle	33
Dry Chemical Nozzle	33
Foam Aeration Tubes	34
Monitor Foam Aeration Tube	56
Self-Educting Monitor Nozzles	54-56
In-Line Eductors	79-80
Portable By-Pass Eductors	80

VALVES

Forestry Wyes	81
Leader Line Wyes	81
Hydrant Wyes	81-82
Plain Wye	82
Water Thief	82
Suction Siamese	83
Clappered Valve Siamese	83
Valves	83

TECHNICAL DATA

Service Kits	84
Flow & Reach Data	85-88
Compatibility Chart	89
Eductor/Nozzle Performance Data	90
Thread Information	91
Metric Conversion	92
Style Number Index	93-94



SELECTABLE GALLONAGE NOZZLES

Protek's Selectable Gallonage Nozzles are combination pattern nozzles with versatile multiple flow settings. The unique stainless steel teeth produce a wide range of patterns from straight stream to full fog. Inlet size is available in 1" (25mm), 1-1/2" (38mm) or 2-1/2" (65mm). Nozzles are available in either lightweight hardcoat anodized aluminium or corrosion resistant brass construction. All nozzles are compatible with Protek's foam aeration tubes. Nozzles are available in tip only configuration and shutoff/playpipe combinations. All Protek nozzles are NFPA compliant.

Features:

- Superb wide fog pattern for optimum fire fighter protection
- Standard operating pressure at 100 psi (7bar), optional 85 psi (6 bar) or 75 psi (5 bar)
- Available in either lightweight hardcoat anodized aluminium or corrosion resistant brass construction
- Available in tip only and shutoff combinations
- Standard stainless steel spinning teeth or optional one-piece moulded fixed teeth
- Meets European standards
- Minimal maintenance reflected in robust design, precision machining and quality materials



Laser-etched anodized label for excellent durability and visibility

Unique series number etched for easy identification

New and improved handle design

Raised lug for easier pattern identification

Reinforced metal pieces improve durability

Flush without changing pattern or shutting down

Stainless filter mesh prevents blockage caused by debris

Baffle etched with pressure (psi and bar)

Choice of 1", 1-1/2" or 2-1/2" swivel inlet

Style 366



Stainless steel spinning teeth

Flow pattern detents facilitate positive positioning and smooth action



Heavy-duty chrome plated metal shutoff ball for smooth action and long life

Ergonomic design pistol grip (available in various colours, see page 40)



SELECTABLE GALLONAGE NOZZLES

1" 360-Series Selectable Gallonage Nozzles

- 5-10-24-40 GPM (19-37-90-150 LPM)
- Optional 1-1/2" inlet size
- Flow setting at 100 psi (7 bar) operating pressure
- Can be used for high pressure applications up to 580 psi (40 bar)
- Compatible with Low and Medium Expansion Foam Tube
Style 210, 211 & 225 (see page 34)



Style 360 or 361

360 1" Selectable Gallonage Nozzle with Pistol Grip

360-TO 1" Selectable Gallonage Nozzle Tip Only

- Twist shutoff optional

360-BA 1" Selectable Gallonage Breakapart Nozzle

Style 360-TO or 361-TO

- Combination of Style 360-TO tip and Style 100 shutoff (see page 35)

360-BC 1" Selectable Gallonage Nozzle with Pistol Grip

- Brass construction

360-BCTO 1" Selectable Gallonage Nozzle Tip Only

- Brass construction



Style 360-BA

1" 361-Series Selectable Gallonage Nozzle

- 13-25-40-60 GPM (50-100-150-230 LPM)
- Optional 1-1/2" inlet size
- Compatible with Low and Medium Expansion Foam Tube
Style 210 & 225 (see page 34)

361 1" Selectable Gallonage Nozzle with Pistol Grip

Style 360-BC or 361-BC

361-TO 1" Selectable Gallonage Nozzle Tip Only

- Twist shutoff optional

361-BC 1" Selectable Gallonage Nozzle with Pistol Grip

- Brass construction

361-BCTO 1" Selectable Gallonage Nozzle Tip Only

- Brass construction



Style 360-BCTO or 361-BCTO

Style	Inlet Size	Length	Weight Lbs(kg)	Flow Settings	
				GPM	LPM
360	1" (25mm)	7.4" (190mm)	2.3 (1.1kg)	5-10-24-40	19-37-90-150
360-TO	1" (25mm)	5.5" (140mm)	1.6 (0.7kg)	5-10-24-40	19-37-90-150
360-BA	1" (25mm)	9.5" (242mm)	3.3 (1.5kg)	5-10-24-40	19-37-90-150
360-BC	1" (25mm)	7.4" (190mm)	5.3 (2.4kg)	5-10-24-40	19-37-90-150
360-BCTO	1" (25mm)	5.5" (140mm)	3.3 (1.5kg)	5-10-24-40	19-37-90-150
361	1" (25mm)	7.4" (190mm)	2.3 (1.1kg)	13-25-40-60	50-100-150-230
361-TO	1" (25mm)	5.5" (140mm)	1.6 (0.7kg)	13-25-40-60	50-100-150-230
361-BC	1" (25mm)	7.4" (190mm)	5.3 (2.4kg)	13-25-40-60	50-100-150-230
361-BCTO	1" (25mm)	5.5" (140mm)	3.3 (1.5kg)	13-25-40-60	50-100-150-230



SELECTABLE GALLONAGE NOZZLES

1" 362-Series Selectable Gallonage Nozzle

- 12-23-30 GPM (50-90-115 LPM)
- Optional 1-1/2" inlet size
- Compatible with Low and Medium Expansion Foam Tube Style 210 & 225 (see page 34)
- Can be used for high pressure applications up to 580 psi (40 bar)

362 1" Selectable Gallonage Nozzle with Pistol Grip

362-TO 1" Selectable Gallonage Nozzle Tip Only

- Twist shutoff optional

362-BC 1" Selectable Gallonage Nozzle with Pistol Grip

- Brass construction

362-BCTO 1" Selectable Gallonage Nozzle Tip Only

- Brass construction



Style	Inlet Size	Length	Weight Lbs(kg)	Flow Settings	
				GPM	LPM
362	1" (25mm)	7.4" (190mm)	2.3 (1.1kg)	12-23-30	50-90-115
362-TO	1" (25mm)	5.5" (140mm)	1.6 (0.7kg)	12-23-30	50-90-115
362-BC	1" (25mm)	7.4" (190mm)	5.3 (2.4kg)	12-23-30	50-90-115
362-BCTO	1" (25mm)	5.5" (140mm)	3.3 (1.5kg)	12-23-30	50-90-115

1-1/2" 366-Series Selectable Gallonage Nozzles

- 30-60-95-125 GPM (115-230-360-475 LPM)
- Optional 2-1/2" inlet size
- 100 psi (7 bar) standard, 75 psi (5 & 6 bar) optional
- Compatible with Low and Medium Expansion Foam Tube Style 212, 213 & 226 (see page 34)

366 1-1/2" Selectable Gallonage Nozzle with Pistol Grip

366-TO 1-1/2" Selectable Gallonage Nozzle Tip Only

- Twist shutoff optional

366-BA 1-1/2" Selectable Gallonage Breakapart Nozzle

- Combination of Style 366-TO tip and Style 101 shutoff (see page 35)

366-BC 1-1/2" Selectable Gallonage Nozzle with Pistol Grip

- Brass construction

366-BCTO 1-1/2" Selectable Gallonage Nozzle with Pistol Grip

- Brass construction



Style	Inlet Size	Length	Weight Lbs(kg)	Flow Settings	
				GPM	LPM
366	1-1/2" (38mm)	9" (228mm)	3.9 (1.7kg)	30-60-95-125	115-230-360-475
366-TO	1-1/2" (38mm)	6.3" (160mm)	2.2 (1kg)	30-60-95-125	115-230-360-475
366-BA	1-1/2" (38mm)	12.4" (315mm)	4.4 (2kg)	30-60-95-125	115-230-360-475
366-BC	1-1/2" (38mm)	9" (228mm)	8.3 (3.7kg)	30-60-95-125	115-230-360-475
366-BCTO	1-1/2" (38mm)	6.3" (160mm)	5.5 (2.5kg)	30-60-95-125	115-230-360-475



SELECTABLE GALLONAGE NOZZLES

366-BI Selectable Gallonage Nozzle with Integrated 2-1/2" Inst. Male

- BIM inlet

366-K 1-1/2" Selectable Gallonage Nozzle

- Dual fixed and spinning teeth enhance quality and efficiency of fog pattern

366-L 1-1/2" Selectable Gallonage Nozzle

- Special fluorescent bumper enables night vision search



Style 366-BI



Style 366-K



Style 366-L

Style	Inlet Size	Length	Weight Lbs(kg)	Flow Settings	
				GPM	LPM
366-BI	2-1/2" (65mm)	12.6" (320mm)	4.4 (2kg)	30-60-95-125	115-230-360-475
366-K	1-1/2"(38mm)	9" (228mm)	3.9 (1.7kg)	30-60-95-125	115-230-360-475
366-L	1-1/2"(38mm)	9" (228mm)	3.9 (1.7kg)	30-60-95-125	115-230-360-475

Mid-Range 367-Series Selectable Gallonage Nozzles

- 95-125-150-200 GPM (360-475-550-750 LPM)
- Optional 2-1/2" inlet size
- 100 psi (7 bar) standard, 75 psi (5 bar) optional
- Compatible with Low and Medium Expansion Foam Tube Style 214, 215 & 226 (see page 34)



Style 367



367 Mid-Range Selectable Gallonage Nozzle with Pistol Grip

367-TO Mid-Range Selectable Gallonage Nozzle Tip Only

367-BA Mid-Range Selectable Gallonage Breakapart Nozzle

- Combination of Style 367-TO tip and Style 102 shutoff (see page 35)

367-BC Mid-Range Selectable Gallonage Nozzle with Pistol Grip

- Brass construction

367-BI Mid-Range Selectable Gallonage Nozzle with Integrated 2-1/2" Inst. Male

- BIM inlet



Style 367-BC

Style	Inlet Size	Length	Weight Lbs(kg)	Flow Settings	
				GPM	LPM
367	1-1/2" (38mm)	10.2" (260mm)	5.7 (2.6kg)	95-125-150-200	360-475-550-750
367-TO	1-1/2" (38mm)	7.1" (180mm)	3.3 (1.5kg)	95-125-150-200	360-475-550-750
367-BA	1-1/2" (38mm)	13.1" (332mm)	6.3 (2.9kg)	95-125-150-200	360-475-550-750
367-BC	1-1/2" (38mm)	10.2" (260mm)	12.7 (5.8kg)	95-125-150-200	360-475-550-750
367-BCTO	1-1/2" (38mm)	7.1" (180mm)	8.6 (3.9kg)	95-125-150-200	360-475-550-750
367-BI	2-1/2" (65mm)	13.8" (350mm)	6.3 (2.9kg)	95-125-150-200	360-475-550-750



SELECTABLE GALLONAGE NOZZLES

Wide-Range 369-Series Selectable Gallonage Nozzles

- 30-60-95-125-150-200 GPM (115-230-360-475-550-750 LPM)
- 100 psi (7 bar) standard, 75 psi (5 bar) optional
- Compatible with Low and Medium Expansion Foam Tube Style 214, 215 & 227 (see page 34)



Style 369

369 Wide-Range Selectable Gallonage Nozzle with Pistol Grip

369-TO Wide-Range Selectable Gallonage Nozzle Tip Only

369-BA Wide-Range Selectable Gallonage Breakapart Nozzle
 • Combination of Style 369-TO tip and Style 102 shutoff (see page 35)



Style	Inlet Size	Length	Weight Lbs(kg)	Flow Settings	
				GPM	LPM
369	1-1/2" (38mm)	10.2" (260mm)	5.7 (2.6kg)	30-60-95-125-150-200	115-230-360-475-550-750
369-TO	1-1/2" (38mm)	7" (178mm)	3.3 (1.5kg)	30-60-95-125-150-200	115-230-360-475-550-750
369-BA	1-1/2" (38mm)	13" (330mm)	6.2 (2.8kg)	30-60-95-125-150-200	115-230-360-475-550-750

High-Range 368-Series Selectable Gallonage Nozzles

- 95-125-150-200-250 GPM (360-475-550-750-950 LPM)
- 100 psi (7 bar) standard, 75 psi (5 bar) optional
- Compatible with Low and Medium Expansion Foam Tube Style 214, 215 & 227 (see page 34)



Style 368-TO



Style 368

368 High-Range Selectable Gallonage Nozzle with Pistol Grip

368-TO High-Range Selectable Gallonage Nozzle Tip Only

368-BA High-Range Selectable Gallonage Breakapart Nozzle
 • Combination of Style 368-TO tip and Style 102 shutoff (see page 35)

368-BC High-Range Selectable Gallonage Nozzle with Pistol Grip
 • Brass construction



Style 368-BA

368-BCTO High-Range Selectable Gallonage Nozzle Tip Only
 • Brass construction

Style 368-BC

Style	Inlet Size	Length	Weight Lbs(kg)	Flow Settings	
				GPM	LPM
368	2-1/2" (65mm)	11" (280mm)	6.3 (2.8kg)	95-125-150-200-250	360-475-550-750-950
368-TO	1-1/2" (38mm)	7.1" (180mm)	3.2 (1.5kg)	95-125-150-200-250	360-475-550-750-950
368-BA	2-1/2" (65mm)	13" (330mm)	6.3 (2.8kg)	95-125-150-200-250	360-475-550-750-950
368-BC	2-1/2" (65mm)	11" (280mm)	14.7 (6.7kg)	95-125-150-200-250	360-475-550-750-950
368-BCTO	1-1/2" (38mm)	7.1" (180mm)	9.9 (4.5kg)	95-125-150-200-250	360-475-550-750-950



SELECTABLE GALLONAGE NOZZLES

368-BI High-Range Selectable Gallonage Nozzle with Integrated 2-1/2" Inst. Male

- BIM inlet

368-TP High-Range Selectable Gallonage Nozzle Tip with Playpipe

- Combination of Style 368-TO tip and Style 130 playpipe (see page 36)

368-BCTP High-Range Selectable Gallonage Nozzle Tip with Playpipe

- Brass construction
- Combination of Style 368-BCTO tip and Style 130-BC playpipe (see page 36)



Style	Inlet Size	Length	Weight Lbs(kg)	Flow Settings	
				GPM	LPM
368-BI	2-1/2" (65mm)	9.9" (250mm)	6.4 (2.9kg)	95-125-150-200-250	360-475-550-750-950
368-TP	1-1/2" (38mm)	11.8" (300mm)	9.5 (4.3kg)	95-125-150-200-250	360-475-550-750-950
368-BCTP	2-1/2" (65mm)	11.8" (300mm)	21 (9.5kg)	95-125-150-200-250	360-475-550-750-950

High-Range 390-Series Selectable Gallonage Nozzle

- 160-200-240-280-320 GPM (600-750-900-1050-1200 LPM)
- 100 psi (7 bar) standard, 75 psi (5 bar) optional
- Compatible with Foam Tube Style 220 (see page 34)



Style 390

390 High-Range Selectable Gallonage Nozzle with Pistol Grip

Style	Inlet Size	Length	Weight Lbs(kg)	Flow Settings	
				GPM	LPM
390	2-1/2" (65mm)	11" (280mm)	5.5 (2.5kg)	160-200-240-280-320	600-750-900-1050-1200

396-Series Selectable Gallonage Nozzle with Trigger shutoff

- 30-60-95-125 GPM (115-230-360-475 LPM)
- Flow setting at 100 psi (7 bar) operating pressure
- Customised flow settings available on request
- Adjust flow by turning the flow selection ring
- Trigger shutoff automatically shuts off flows when released



Style 396

396 High-Range Selectable Gallonage Nozzle with Pistol Grip

Style	Inlet Size	Length	Weight Lbs(kg)	Flow Settings	
				GPM	LPM
396	1-1/2" (38mm)	9" (228mm)	3.9 (1.7kg)	30-60-95-125	115-230-360-475



EN SELECTABLE GALLONAGE NOZZLES

Protek's EN Selectable Gallonage Nozzles are combination pattern nozzles with multiple flow settings at lower operating pressure. The nozzles are designed to meet EN 15182-2 Type 3 and DIN 14367 compliance requirements. Inlet size is available in 1" (25mm), 1-1/2" (38mm) or 2-1/2" (65mm). Nozzles are available in lightweight hardcoat anodized aluminium construction. All nozzles are compatible with Protek's foam aeration tubes.

Features:

- EN 15182-2 Type 3 and DIN 14367 compliant
- Combination pattern nozzle with multiple flow settings for operator flow control
- Easy to operate with a-quarter turn from straight stream to fog
- One-click turn of the moulded bumper ring to flashover pattern position
- Raised lug on the bumper for flashover fog pattern
- Maximum flow position touch button on the flow selection control ring
- Exceptionally lightweight and compact



EN SELECTABLE GALLONAGE NOZZLES

EN Selectable Gallonage Nozzles

- 2360 1" EN Selectable Gallonage Nozzle with Pistol Grip**
- 20-40-100-150 LPM at 6 bar
 - Compatible with Low and Medium Expansion Foam Tube Style 210 & 225 (see page 34)
 - Can be used for high pressure applications up to 580 psi (40 bar)



Style 2360 or 2361

- 2361 1" EN Selectable Gallonage Nozzle with Pistol Grip**
- 50-100-150-230 LPM at 6 bar
 - Compatible with Low and Medium Expansion Foam Tube Style 210 & 225 (see page 34)

- 2365 1.5" EN Selectable Gallonage Nozzle with Pistol Grip**
- 70-130-230-400 LPM at 6 bar
 - Compatible with Low and Medium Expansion Foam Tube Style 213 & 226 (see page 34)



Style 2365 or 2366

- 2366 1.5" EN Selectable Gallonage Nozzle with Pistol Grip**
- 100-250-350-500 LPM at 6 bar
 - Compatible with Low and Medium Expansion Foam Tube Style 213 & 226 (see page 34)

- 2368 2.5" EN Selectable Gallonage Nozzle with Pistol Grip**
- 285-500-600-800-950 LPM at 6 bar
 - Compatible with Foam Tube Style 220 (see page 34)



Style 2368

- 2368-TP 2.5" EN Selectable Gallonage Nozzle Tip with Playpipe**
- 285-500-600-800-950 LPM at 6 bar
 - Compatible with Foam Tube Style 220 (see page 34)



Style 2368-TP

Style	Inlet Size	Length	Weight	Flow Settings	
				LPM	Pressure
2360	1" BSP F	19 cm	1.2 kg	20-40-100-150	6 bar
2361	1" BSP F	19 cm	1.2 kg	50-100-150-230	6 bar
2365	1.5" BSP F	21.5 cm	1.6 kg	70-130-230-400	6 bar
2366	1.5" BSP F BS 336 Inst.	22.8 cm	1.6 kg	100-250-350-500	6 bar
2368	2.5" BSP F BS 336 Inst.	27.9 cm	2.5 kg	285-500-600-800-950	6 bar
2368-TP	2.5" BSP F BS 336 Inst.	43.1 cm	4.2 kg	285-500-600-800-950	6 bar



MULTI-MODE NOZZLES

Protek's new-generation Multi-Mode Nozzle is a dynamic nozzle with combined pulsing, selectable, automatic and low-pressure modes. These versatile nozzles combine controlled stream quality, reduced pressure on fire fighters and pump, optimum flow rate at regulated pressure and maximum selectable flows. Change in the flow pattern can readily be achieved via an efficient 120° turn of the moulded bumper. Enhanced positivity of the flow selection ring and ball-valve shut off delivers optimal stream performance and effective operating control slide-valve design reduces turbulence and controls flow rate whilst preserving quality stream. Inlet size is available in 1" (25mm), 1-1/2" (38mm) or 2-1/2" (65mm). All Protek nozzles are NFPA compliant.

Features:

- Combination pattern nozzle with combined pulsing, selectable, automatic and low pressure modes
- Slide-valve design reduces turbulence and controls flow rate whilst preserving quality stream
- Efficient 120° turn of the moulded bumper from jet stream to fog pattern
- Shock absorber in the bumper for greater resilience
- Improved positivity of flow selection ring ensures optimal stream performance
- Large index ring with indicator allows easy flow, pressure or flush selections with a gloved hand
- Optimal straight stream and fog pattern performance are achieved at the selected flow setting



1-1/2" 325 Multi-Mode Nozzle

- Pulsing 30 GPM @ 100 psi (115 LPM @ 7 bar), automatic 60 GPM @ 90 psi (230 LPM @ 6.5 bar) and low pressure 80 GPM @ 85 psi (300 LPM @ 6 bar)
- Compatible with Foam Tube Style 208 (see page 34)
- Optional stainless steel spinning teeth

Style	Inlet Size	Length	Weight Lbs(kg)	Flow Settings	
				GPM	LPM
325	1-1/2" (38mm)	9.7" (247mm)	3 (1.4kg)	PULSING 30 GPM @ 100 psi	PULSING 115 LPM @ 7 bar
				AUTOMATIC 60 GPM @ 90 psi	AUTOMATIC 230 LPM @ 6.5 bar
				LOW PRESSURE 80 GPM @ 85 psi	LOW PRESSURE 300 LPM @ 6 bar



Style 325



Style 326

1-1/2" 326 Multi-Mode Nozzle

- Pulsing 80 GPM @ 100 psi (300 LPM @ 7 bar), automatic 130 GPM @ 85 psi (500 LPM @ 6 bar) and low pressure 170 GPM @ 75 psi (635 LPM @ 5 bar)
- Compatible with Foam Tube Style 209 (see page 34)
- Optional stainless steel spinning teeth

Style	Inlet Size	Length	Weight Lbs(kg)	Flow Settings	
				LPM	Pressure
326	1-1/2" (38mm)	11.2" (284mm)	5.4 (2.5kg)	PULSING 80 GPM @ 100 psi	PULSING 300 LPM @ 7 bar
				AUTOMATIC 130 GPM @ 85 psi	AUTOMATIC 500 LPM @ 6 bar
				LOW PRESSURE 170 GPM @ 75 psi	LOW PRESSURE 625 LPM @ 5 bar



MULTI-PURPOSE NOZZLES

Protek's Multi-Purpose Nozzles are technologically advanced nozzles with synchronised solid bore and fog stream capability. The nozzle offers the flexibility to flow both at the same time or independently. Solid bore provides excellent reach and penetration at low pressure, whilst fog stream offers protection and rapid cooling. Inlet size is available in either 1-1/2" (38mm) or 2-1/2" (65mm). Nozzles are capable of operating efficiently at pressures as low as 50 psi to reduce fire fighter fatigue or up to 100 psi for maximum flow. All Protek nozzles are NFPA compliant.

Features:

- Operates effectively from 50 psi (3.5 bar) to 100 psi (7 bar)
- Exceptionally lightweight and compact
- Suitable for use with CAFS systems
- Conforms to all aspects of NFPA 1964 (Spray, Nozzles, Shutoff and Tips)

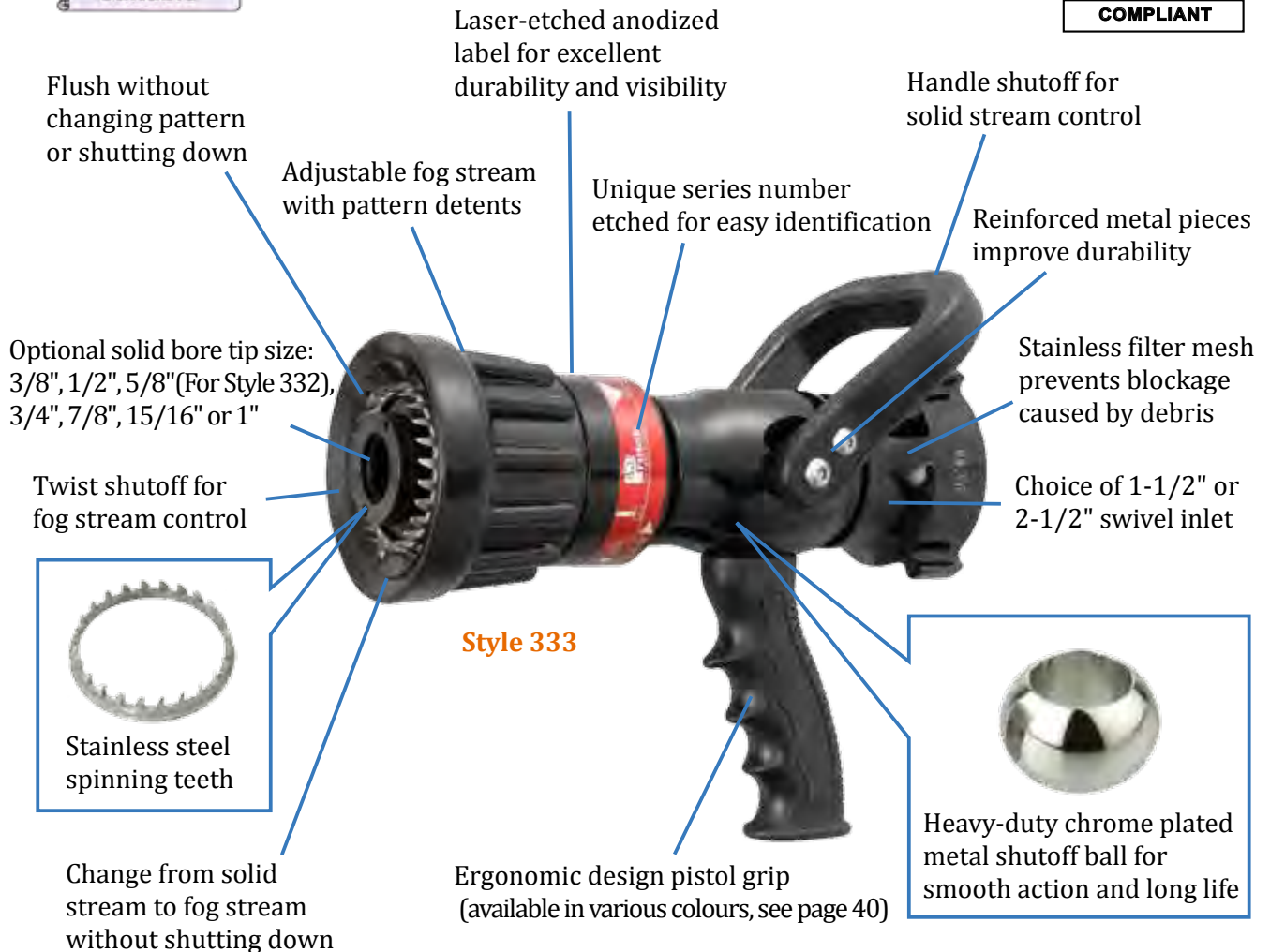

MULTI-PURPOSE NOZZLES

Style 332 Flow Chart

332-Series Multi-Purpose Nozzle

332 1-1/2" Multi-Purpose Nozzle with Pistol Grip

- Optional solid bore tip size of 3/8", 1/2" or 5/8"
- Operating pressure up to 100 psi
- Compatible with Foam Tube Style 212 (see page 34)



Style 332

Tip Size	Inlet Pressure(PSI)	Solid Bore Flow(GPM)	Fog Flow (GPM)	Combination Flow(GPM)
3/8"	50	23	42	66
	75	30	50	75
	100	36	60	95
1/2"	50	45	42	86
	75	60	50	110
	100	66	60	120
5/8"	50	75	42	105
	75	95	50	135
	100	100	60	155



FOG



SOLID BORE



COMBINATION STREAMS

333-Series Multi-Purpose Nozzle

333 1-1/2" or 2-1/2" Multi-Purpose Nozzle with Pistol Grip

- Optional solid bore tip size of 3/4", 7/8", 15/16" or 1"
- Operating pressure up to 100 psi
- Compatible with Foam Tube Style 214 (see page 34)



Style 333 Flow Chart



Style 333

Tip Size	Inlet Pressure(PSI)	Solid Bore Flow(GPM)	Fog Flow (GPM)	Combination Flow(GPM)
3/4"	50	115	95	199
	75	140	115	245
	100	160	135	285
7/8"	50	155	95	232
	75	195	115	295
	100	220	135	340
15/16"	50	180	95	250
	75	195	115	300
	100	250	135	365
1"	50	205	95	270
	75	240	115	340
	100	285	135	385

Style	Inlet Size	Length	Weight Lbs(kg)	Tip Options	Fog at 100PSI	
					GPM	LPM
332	1-1/2" (38mm)	8.6" (218mm)	3.5 (1.6kg)	3/8", 1/2", 5/8"	60	230
333	1-1/2" or 2-1/2"	11" (280mm)	5.8 (2.6kg)	3/4", 7/8", 15/16", 1"	135	510



AUTOMATIC NOZZLES

Protek's Automatic Nozzles by design adjust to fluctuating water flow to maintain effective pressure and a consistent stream in all flow ranges. Nozzles are adjustable from straight stream to fog pattern. Nozzles flush easily without shutting down and provide a constant flow in either fog or straight stream. Inlet size is available in 1" (25mm), 1-1/2" (38mm) or 2-1/2" (65mm). All nozzles are compatible with Protek's foam aeration tubes. Nozzles are available in ball/slide valve configurations and shutoff/playpipe combinations. All Protek nozzles are NFPA compliant.

Features:

- Extensive range of flow settings
- Exceptionally lightweight and compact
- Minimal maintenance reflected in robust design, precision machining and quality materials
- Conforms to all aspects of NFPA 1964 (Spray, Nozzles, Shutoff and Tips)



Slide Valve Control available in Style 321, 322, 323, 324	Ball Valve Control available in Style 310, 311, 312, 314
---	--



Style 323-DP

Optional fixed moulded teeth or stainless steel spinning teeth

Laser-etched anodized label for excellent durability and visibility

Flow-rate control handle with multiple flows and closure (slide valve control)

Choice of either ball valve control or slide valve control

Stainless filter mesh prevents blockage caused by debris

Choice of 1", 1-1/2" or 2-1/2" swivel inlet

Ergonomic design pistol grip (available in various colours, see page 40)

Spray angle lock option available in Style 322-SP

Change from solid to fog stream without shutting down

Flow pattern detents facilitate positive positioning and smooth action

Optional dual pressure settings via adjustment of the baffle



1" and 1-1/2" Ball-Valve Automatic Nozzles

310 1" Automatic Nozzle with Pistol Grip

- 10-75 GPM (40-285 LPM)
- Ball valve control
- Spinning teeth
- Compatible with Foam Tube Style 212 (see page 34)



Style 310

311 1-1/2" Automatic Nozzle with Pistol Grip

- 60-125 GPM (230-475 LPM)
- Ball valve control
- Spinning teeth
- Compatible with Foam Tube Style 212 (see page 34)



Style 311

1-1/2" Ball-Valve Automatic Nozzle

312 1-1/2" Automatic Nozzle with Pistol Grip

- 60-200 GPM (230-750 LPM)
- Ball valve control
- Spinning teeth
- Compatible with Foam Tube Style 214 (see page 34)



Style 312

2-1/2" Ball-Valve Automatic Nozzles

- 75-350 GPM (280-1325 LPM)
- Ball valve control
- Spinning teeth
- Compatible with Foam Tube Style 217 (see page 34)



Style 314

314 2-1/2" Automatic Nozzle with Pistol Grip

314-TP 2-1/2" Automatic Nozzle with Playpipe



Style 314-TP

Style	Inlet Size	Length	Weight Lbs(kg)	Flow Settings	
				GPM	LPM
310	1" (25mm)	9.1" (229mm)	3.7 (1.7kg)	10-75	40-285
311	1-1/2" (38mm)	9.2" (234mm)	3.7 (1.7kg)	60-125	230-475
312	1-1/2" (38mm)	10.6" (269mm)	5.6 (2.5kg)	60-200	230-750
314	2-1/2" (65mm)	12.2" (309mm)	8.0 (3.6kg)	75-350	280-1325
314-TP	2-1/2" (65mm)	17.1" (435mm)	9.9 (4.5kg)	75-350	280-1325



AUTOMATIC NOZZLES

1" and 1-1/2" Slide-Valve Automatic Nozzles

- 10-125 GPM (40-475 LPM)
- Slide valve control
- Fixed teeth
- Compatible with Foam Tube Style 216 (see page 34)

321 **1" Automatic Nozzle with Pistol Grip**



Style 321

322 **1-1/2" Automatic Nozzle with Pistol Grip**

322-SP **1-1/2" Automatic Nozzle with Pistol Grip**

- Lockage spray angle of 40° that can be reset to 110°



Style 322



Style 322-SP



Lockable spray angle of 40° which can be reset to 110°



Style	Inlet Size	Length	Weight Lbs(kg)	Flow Settings	
				GPM	LPM
321	1" (25mm)	8.6" (220mm)	3.1 (1.4kg)	10-125	40-475
322	1-1/2" (38mm)	9.0" (230mm)	3.2 (1.4kg)	10-125	40-475
322-SP	1-1/2" (38mm)	9.0" (230mm)	3.2 (1.4kg)	10-125	40-475



1-1/2" Slide-Valve Automatic Nozzles

- 70-200 GPM (265-750 LPM)
- Slide valve control
- Fixed teeth
- Compatible with Foam Tube Style 218 (see page 34)

Style 323



Style 323-DP



323 **1-1/2" Automatic Nozzle with Pistol Grip**

323-DP **1-1/2" Dual Pressure Nozzle with Pistol Grip**

- Dual pressure setting offers the unique ability to change operating nozzle pressure
- Pressure mode is interchangeable between rated pressure and low pressure, such as 100 psi and 75 psi
- Switch between pressure modes via an easy twist of the knob on the end of the baffle
- High operating pressure provides the ability to aggressively conduct a hard-hitting fire attack
- Low operating pressure reduces the reaction torque at initial discharge
- Conforms to all aspects of NFPA 1964 (Spray, Nozzles, Shutoff and Tips)

Style	Inlet Size	Length	Weight Lbs(kg)	Flow Settings	
				GPM	LPM
323	1-1/2" (38mm)	11" (280mm)	5.1 (2.3kg)	70-200	265-750
323-DP	1-1/2" (38mm)	11" (280mm)	5.1 (2.3kg)	70-200	265-750

2-1/2" Slide-Control Automatic Nozzles

- 50-350 GPM (190-1325 LPM)
- Slide valve control
- Fixed teeth
- Compatible with Foam Tube Style 219 (see page 34)



Style 324

324 **2-1/2" Automatic Nozzle with Pistol Grip**

324-TP **2-1/2" Automatic Nozzle with Playpipe**



Style 324-TP

Style	Inlet Size	Length	Weight Lbs(kg)	Flow Settings	
				GPM	LPM
324	2-1/2" (65mm)	12.6" (320mm)	7.5 (3.4kg)	50-350	190-1325
324-TP	2-1/2" (65mm)	15" (381mm)	10.6 (4.8kg)	50-350	190-1325



CONSTANT GALLONAGE NOZZLES

Protek's Constant Gallonage Nozzles effectively deliver a constant gallonage from straight stream to full fog. The nozzle combines quality stream performance at various pressures with the simplicity of a fixed orifice. Nozzles are affordably priced, easy to use and reliable in tough situations. Inlet size is available in 1" (25mm), 1-1/2" (38mm) or 2-1/2" (65mm). Nozzles are available in either lightweight hardcoat anodized aluminium or corrosion resistant brass construction. All nozzles are compatible with Protek's foam aeration tubes. Nozzles are available in shutoff/playpipe combinations. All Protek nozzles are NFPA compliant.

Features:

- Constant single-flow nozzle delivered with a calibrated flow disc installed
- Superb wide fog pattern for optimum fire fighter protection
- Excellent performance at pressure as low as 50 psi (3.5 bar)
- Standard operating pressure at 100 psi (7bar), optional 85 psi (6 bar) or 75 psi (5 bar)
- Available in either lightweight hardcoat anodized aluminium or corrosion resistant brass construction
- Available in tip only and shutoff combinations
- Minimal maintenance reflected in robust design, precision machining and quality materials
- Custom flow and pressure combinations are available on request



Style 372-BC

Flow pattern detents facilitate positive positioning and smooth action

Laser-etched anodized label for excellent durability and visibility

Fixed moulded teeth or stainless steel spinning teeth

Unique series number for easy identification

New and improved handle design

Stainless filter mesh prevents blockage caused by debris

Constant flow regardless of pattern change

Choice of 1", 1-1/2" or 2-1/2" swivel inlet

Heavy-duty chrome plated metal shutoff ball for smooth action and long life

Ergonomic design pistol grip (available in various colours, see page 40)

Custom flow and pressure combinations are available with flow rate etched on the baffle on request

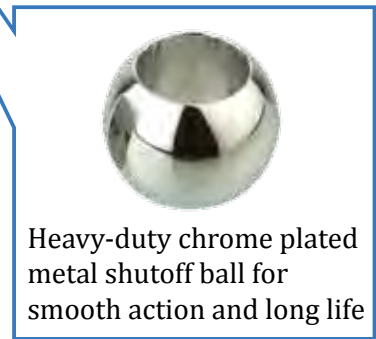

CONSTANT GALLONAGE NOZZLES

1" 371-Series Constant Gallonage Nozzle

- 371, 371-BC 1" Constant Gallonage Nozzle with Pistol Grip**
- 13, 25, 40 or 60 GPM (50, 100, 150 or 230 LPM)
 - Optional 1-1/2" inlet size
 - 100 psi (7 bar) standard, 85 psi (6 bar) optional
 - Compatible with Foam Tube Style 211 (see page 34)

371-TO 1" Constant Gallonage Nozzle Tip Only

371-BCTO 1" Constant Gallonage Nozzle Tip Only

- Brass construction



Style 371

Style	Inlet Size	Length	Weight Lbs(kg)	Flow Settings	
				GPM	LPM
371	1" (25mm)	7.1" (180mm)	2.1 (0.9kg)	13, 25, 40 or 60	50, 100, 150 or 230
371-BC	1" (25mm)	7.1" (180mm)	5.3 (2.4kg)	13, 25, 40 or 60	50, 100, 150 or 230

1-1/2" 372-Series Constant Gallonage Nozzles

- 60, 95 or 125 GPM (230, 360 or 475 LPM)
- Optional 2-1/2" inlet size
- Flow setting at 100 psi (7 bar) operating pressure
- Compatible with Foam Tube Style 212 (see page 34)

372 1-1/2" Constant Gallonage Nozzle with Pistol Grip

372-TO 1-1/2" Constant Gallonage Nozzle Tip Only

372-BA 1-1/2" Constant Gallonage Breakapart Nozzle

- Combination of Style 372-TO tip and Style 101 shutoff (see page 35)

372-BC 1-1/2" Constant Gallonage Nozzle with Pistol Grip

- Industrial nozzle
- Brass construction

372-BCTO 1-1/2" Constant Gallonage Nozzle Tip Only

- Brass construction



Style 372



Style 372-BC



Style	Inlet Size	Length	Weight Lbs(kg)	Flow Settings	
				GPM	LPM
372	1-1/2" (38mm)	8.5" (216mm)	3.6 (1.6kg)	60, 95 or 125	230, 360 or 475
372-TO	1-1/2" (38mm)	5.9" (150mm)	1.9 (0.8kg)	60, 95 or 125	230, 360 or 475
372-BA	1-1/2" (38mm)	12" (305mm)	4.2 (1.9kg)	60, 95 or 125	230, 360 or 475
372-BC	1-1/2" (38mm)	8.5" (216mm)	7.5 (3.4kg)	60, 95 or 125	230, 360 or 475
372-BCTO	1-1/2" (38mm)	5.9" (150mm)	5.1 (2.3kg)	60, 95 or 125	230, 360 or 475



CONSTANT GALLONAGE NOZZLES

1-1/2" 373-Series Constant Gallonage Nozzles

- 150, 175 or 200 GPM (550, 660 or 750 LPM)
- Flow setting at 100 psi (7 bar) operating pressure
- Compatible with Foam Tube Style 214 (see page 34)

373 **1-1/2" Constant Gallonage Nozzle with Pistol Grip**



Style 373

373-TO **1-1/2" Constant Gallonage Nozzle Tip Only**

373-BA **1-1/2" Constant Gallonage Breakapart Nozzle**

- Combination of Style 373-TO tip and Style 102 shutoff (see page 35)



Style 373-BC

373-BC **1-1/2" Constant Gallonage Nozzle with Pistol Grip**

- Industrial nozzle
- Brass construction

Style	Inlet Size	Length	Weight Lbs(kg)	Flow Settings	
				GPM	LPM
373	1-1/2" (38mm)	10.2" (259mm)	5.7 (2.6kg)	150, 175 or 200	550, 660 or 750
373-TO	1-1/2" (38mm)	7.4" (188mm)	3.3 (1.5kg)	150, 175 or 200	550, 660 or 750
373-BA	1-1/2" (38mm)	12.8" (325mm)	6.4 (2.9kg)	150, 175 or 200	550, 660 or 750
373-BC	1-1/2" (38mm)	9.8" (249mm)	12.7 (5.8kg)	150, 175 or 200	550, 660 or 750

Mid-Range 374-Series Constant Gallonage Nozzles

- 150, 175, 200 or 250 GPM (550, 660, 750 or 950 LPM)
- Flow setting at 100 psi (7 bar) operating pressure
- Compatible with Foam Tube Style 214 (see page 34)

374 **Mid-Range Constant Gallonage Nozzle with Pistol Grip**



Style 374

374-BC **Mid-Range Constant Gallonage Nozzle with Pistol Grip**

- Industrial nozzle
- Brass construction



Style 374-BC



Style	Inlet Size	Length	Weight Lbs(kg)	Flow Settings	
				GPM	LPM
374	2-1/2" (65mm)	11" (279mm)	6.2 (2.8kg)	150, 175, 200 or 250	550, 660, 750 or 950
374-BC	2-1/2" (65mm)	11" (279mm)	14.7 (6.7kg)	150, 175, 200 or 250	550, 660, 750 or 950



CONSTANT GALLONAGE NOZZLES

Mid-Range 374-Series Constant Gallonage Nozzles

374-TP Mid-Range Constant Gallonage Nozzle with Playpipe

374-BCTP Mid-Range Constant Gallonage Nozzle with Playpipe

- Industrial nozzle
- Brass construction



Style 374-TP



Style 374-BCTP

Style	Inlet Size	Length	Weight Lbs(kg)	Flow Settings	
				GPM	LPM
374-TP	2-1/2" (65mm)	16.7" (424mm)	9.5 (4.3kg)	150, 175, 200 or 250	550, 660, 750 or 950
374-BCTP	2-1/2" (65mm)	17" (432mm)	21 (9.5kg)	150, 175, 200 or 250	550, 660, 750 or 950

High-Range 375-Series Constant Gallonage Nozzle

375 High-Range Constant Gallonage Nozzle with Pistol Grip

- 200, 250, 300 or 350 GPM (750, 950, 1140 or 1325 LPM)
- Flow setting at 100 psi (7 bar) operating pressure
- Compatible with Foam Tube Style 217 (see page 34)



Style 375

375-TO High-Range Constant Gallonage Nozzle Tip Only

- Varying flow settings with an easy turn of the baffle
- Flow rates are etched on the baffle
- Optional 1-1/2" or 2-1/2" inlet size
- Can be used as an attachment to Protek monitors
Style 611, 600-1 and 600-2



Style 375-TO

1.5" inlet

2.5" inlet

Style	Inlet Size	Length	Weight Lbs(kg)	Flow Settings	
				GPM	LPM
375	2-1/2" (65mm)	11.8" (300mm)	7.5 (3.4kg)	200, 250, 300 or 350	750, 950, 1140 or 1325
375-TO	1-1/2" (38mm)	8.8" (223mm)	5.1 (2.3kg)	200, 250, 300 or 350	750, 950, 1140 or 1325
	2-1/2" (65mm)	9.5" (240mm)	5.7 (2.6kg)		



LOW PRESSURE NOZZLES

Protek's Low Pressure Nozzles are designed to produce versatile flow rates with combination pattern at low operating pressures. These nozzles effectively minimise pressure on pumps and fire fighter fatigue whilst delivering more water. Change in the flow pattern can readily be achieved via an efficient 120° turn of the moulded bumper. Enhanced positivity of the flow selection ring and ball-valve shut off deliver optimal stream performance and effective operating control. Inlet size is available in 1" (25mm), 1-1/2" (38mm) or 2-1/2" (65mm). All Protek nozzles are NFPA compliant.

Features:

- Versatile five multiple flow rate settings, up to 200 GPM (750 LPM) at 5 bar (75 psi)
- Effectively minimises pressure on pumps and fire fighter fatigue whilst delivering more water
- Shock absorber in the bumper for greater resilience
- Efficient 120° turn of the moulded bumper from jet stream to fog pattern
- Enhanced positivity of the flow selection ring and ball-valve shut off

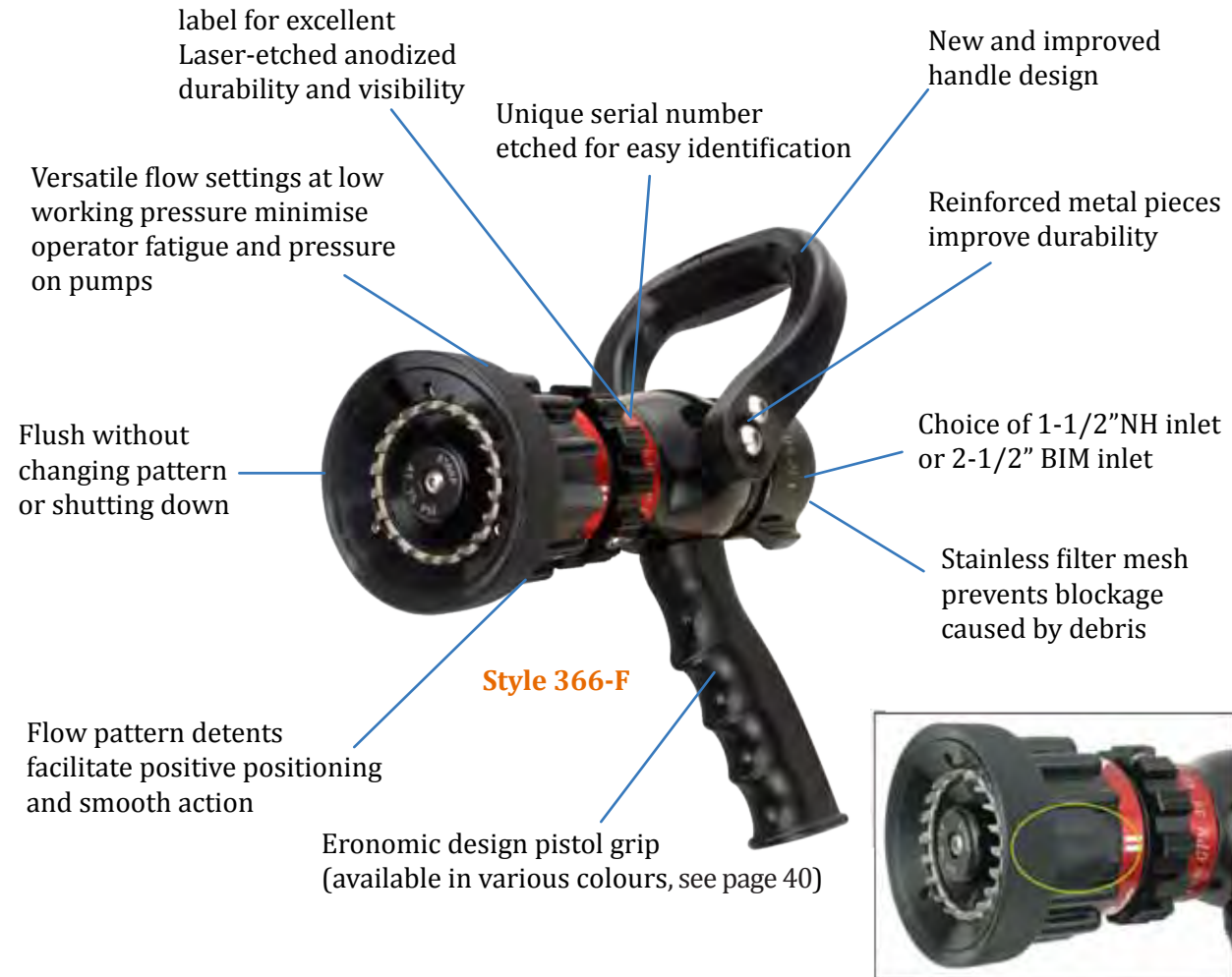

Raised lug for flashover fog pattern with quick 120° turn of the moulded bumper from jet stream to fog pattern
Available in stainless steel spinning teeth



LOW PRESSURE NOZZLES

361-F 1" Low-Pressure Selectable Gallonage Nozzle

- 13-25-40-60 GPM (50-100-150-230 LPM) @ 5 bar (75 psi)
- Exceptionally lightweight and compact
- Optional stainless steel spinning teeth
- Compatible with Low and Medium Expansion Foam Tube Style 210 & 225 (see page 34)



Style 361-F

366-F 1-1/2" Low-Pressure Selectable Gallonage Nozzle

- 30-60-95-125-150 GPM (115-230-360-475-570 LPM) at 5 bar (75 psi)
- Exceptionally lightweight and compact
- Optional stainless steel spinning teeth
- Compatible with Low and Medium Expansion Foam Tube Style 213 & 226 (see page 34)



Style 366-F

372-F 1-1/2" Low-Pressure Constant Gallonage Nozzle

- 60, 95, 125 or 150 GPM (230, 360, 470 OR 570 LPM) @ 5 bar (75 psi)
- Exceptionally lightweight and compact
- Optional stainless steel spinning teeth
- Compatible with Low and Medium Expansion Foam Tube Style 213 & 226 (see page 34)



Style 372-F

Style	Inlet Size	Length	Weight Lbs(kg)	Flow Settings @ 5 bar (75 psi)	
				GPM	LPM
361-F	1" (25mm)	7.3" (186mm)	2.3 (1.1kg)	13-25-40-60	50-100-150-230
366-F	1-1/2" (38mm)	9" (228mm)	3.9 (1.7kg)	30-60-95-125-150	115-230-360-475-570
372-F	1-1/2" (38mm)	8.5" (216mm)	3.5 (1.6kg)	60, 95, 125 or 150	230, 360, 470 or 570

350 1-1/2" Selectable Gallonage Nozzle

- 12-30-60-80 GPM (45-115-230-300 LPM) at 7 bar (100 psi)
- Slide valve control
- Optional stainless steel spinning teeth
- Compatible with Foam Tube Style 208 (see page 34)



Style 350

352 1-1/2" Selectable Gallonage Nozzle

- 30-60-80 GPM (115-230-300 LPM) at 7 bar (100 psi)
- Slide valve control
- Optional stainless steel spinning teeth
- Compatible with Foam Tube Style 208 (see page 34)



Style 352

Style	Inlet Size	Length	Weight Lbs(kg)	Flow Settings @ 5 bar (75 psi)	
				GPM	LPM
350	1-1/2" (38mm)	9.7" (247mm)	3 (1.4kg)	12-30-60-80	45-115-230-300
352	1-1/2" (38mm)	9.7" (247mm)	3 (1.4kg)	30-60-80	115-230-300



LOW PRESSURE NOZZLES

355 1-1/2" Low-Pressure Selectable Gallonage Nozzle

- 30-60-95-125-150 GPM (115-230-360-475-570 LPM) at 5 bar (75 psi)
- Slide valve control
- Optional stainless steel spinning teeth
- Compatible with Foam Tube Style 209 (see page 34)



356 1-1/2" Low-Pressure Selectable Gallonage Nozzle

- 30-60-95-125-150 GPM (115-230-360-475-570 LPM) at 5 bar (75 psi)
- Ball valve control
- Optional stainless steel spinning teeth
- Compatible with Foam Tube Style 209 (see page 34)

357 Mid-Range Low-Pressure Selectable Gallonage Nozzle

- 60-95-125-150-200 GPM (230-360-475-570-750 LPM) at 5 bar (75 psi)
- Ball valve control
- Optional stainless steel spinning teeth
- Compatible with Foam Tube Style 209 (see page 34)



Style	Inlet Size	Length	Weight Lbs(kg)	Flow Settings @ 5 bar (75 psi)	
				GPM	LPM
355	1-1/2" (38mm)	11.2" (284mm)	5.3 (2.4kg)	30-60-95-125-150	115-230-360-475-570
356	1-1/2" (38mm)	10.5" (267mm)	5.3 (2.4kg)	30-60-95-125-150	115-230-360-475-570
357	1-1/2" or 2-1/2" (38mm or 65mm)	11.9" (302mm)	6.6 (3kg)	60-95-125-150-200	230-360-475-570-750



HIGH PRESSURE NOZZLES

Protek's High Pressure Nozzles are designed to produce powerful streams at higher pressures. Nozzles are adjustable from straight stream to fog pattern. The ergonomically designed trigger shutoff automatically shuts off flow when released. In our Style 305 nozzle, the trigger can also be locked in five different positions to control shutoff, protection fog and straight jet. Our high-pressure piercing applicator with trigger shutoff (Style 304) provides quick and powerful penetration through masonry walls and hidden trouble spots. Nozzles are designed for high pressure applications of up to 700 psi (48 bar). Various flow settings are available on request.

Features:

- For high pressure applications up to 700 psi (48 bar)
- High quality, harder hitting, straight stream performance
- Customised flow settings available on request
- Flush without shutting down



Various choice of selectable flow settings

Breakapart model with Style 104 shutoff

Hardcoat anodized alloy construction for durability



Style 104 shutoff



Additional pistol grip for excellent control and reduced fire fighter fatigue



Operational flow lock

Automatically shuts off flow when released



HIGH PRESSURE NOZZLES

High Pressure Nozzles

- For high pressure applications up to 700 psi (48 bar)
- High quality, harder hitting, straight stream performance
- Lightweight and compact
- Trigger shutoff automatically shuts off flow when released
- 5-10-24-40 GPM (19-37-90-150 LPM)
- Customised flow settings available on request
- Compatible with Foam Tube Style 211 for enhanced foam application (see page 34)



Style 302

302 High Pressure Nozzle with Trigger Shutoff and Pistol Grip

- Additional pistol grip for excellent control at high working pressures



Style 303

303 High Pressure Nozzle with Trigger Shutoff

High Pressure Piercing Applicator with Trigger Shutoff and Pistol Grip

304 High Pressure Piercing Applicator with Trigger Shutoff and Pistol Grip

- Hardened tool steel point for driving through windows, crevice in concrete block and mobile homes
- Designed to get water into difficult hidden spots
- Produces impinging jets for a dense fog pattern



Style 304

High Pressure Nozzle with Adjustable Trigger Control

305 High Pressure Nozzle with Adjustable Trigger Control

- Suitable for single-hand operation
- Chrome-plated brass and stainless steel construction
- For operating pressures between 10 bar to 50 bar
- Trigger can be locked in five different positions from shutoff to protecting fog to straight jet



Style 305

High Pressure Trigger Shutoff and Pistol Grip

306 High Pressure Trigger Shutoff and Pistol Grip

- Capacity to flow 50 GPM (200 LPM) at 580 psi (40 bar)
- Quick connecting system, very easy to extend with foam unit



Style 306

Style	Inlet Size	Length	Weight Lbs(kg)	Flow Settings	
				GPM	LPM
302	1" (25mm)	19.7" (500mm)	4.6 (2.1kg)	5-10-24-40@100psi	19-37-90-150@7bar
303	1" (25mm)	13" (330mm)	3.7 (1.7kg)	5-10-24-40@100psi	19-37-90-150@7bar
304	1" (25mm)	38" (965mm)	7 (3.2kg)	15 @ 100 psi	55 @ 7 bar
305	1" (25mm)	16" (406mm)	5.5 (2.5kg)	17 or 30@145psi	65 or 115@10bar
306	1" (25mm)	16" (406mm)	4.4 (2kg)	50 @ 580 psi	200 @ 40 bar



Shockless Nozzles

- Constant flow nozzles with multiple pattern setting
- Tough, corrosion resistant design for harsh industrial and marine environment
- Twist shutoff control reduces the jet reaction force at initial discharge
- Simple operation via the following settings: Off - Fog - Jet - Fog - Off
- Wide 120° fog pattern provides optimum fire fighter protection
- Durable brass construction

387-BC Shockless Nozzle

- Standard 95 GPM (360 LPM)
- Other flows available on request
- 1-1/2" threaded or 2-1/2" BIM

388-BC Shockless Nozzle

- Standard 200 GPM (750 LPM)
- Other flows available on request
- 1-1/2", 2-1/2" threaded or 2-1/2" BIM



Style 387-BC



Style 388-BC

Protek Shockless Nozzle:

Fog pattern at initial discharge significantly reduces fire fighter fatigue by reducing reaction torque



Typical Nozzle:

Jet stream pattern at initial discharge creates reaction torque for fire fighter



Style	Inlet Size	Length	Weight Lbs(kg)	Flow Settings	
				GPM	LPM
387-BC	1-1/2"(38mm) or 2-1/2"(65mm)	8.6" (220mm)	6.8 (3.1kg)	95	360
388-BC	1-1/2"(38mm) or 2-1/2"(65mm)	10.6" (269mm)	12.1 (5.5kg)	200	750



RETRACTABLE FOAM NOZZLES

Protek's Selectable Gallonage Foam Nozzle are combination pattern nozzles with versatile multiple flow settings and retractable foam aspirating sleeve. The nozzle offers the flexibility to aspirate foam and flow stream and fog in a single dynamic model. Available in either lightweight hardcoat anodized aluminium or corrosion resistant brass construction. Nozzles are available in tip only configuration and shutoff combinations.

Features:

- Designed for water and foam applications with Class A, AFFF foam and other various foam types
- Dynamic nozzle with retractable foam aspiration sleeve
- Suitable for use with eductors and on-board foam proportioning systems
- Efficiently transforms from aspirated foam to wide protective fog pattern



To activate aspirating function, slide the outer sleeve forward and adjust to narrow fog or stream pattern in order to control reach and aspiration. If immediate wide fog pattern is required, the sleeve can be retracted instantly to its water discharge position.



RETRACTABLE FOAM NOZZLES

366E-Series Selectable Gallonage Foam Nozzle

- Combination pattern nozzle with versatile multiple flow settings
- Ability to instantly aspirate foam by sliding inbuilt sleeve forward
- No foam aeration tube required for aspiration foam
- Stainless steel spinning teeth for superior fog pattern
- 30-60-95-125 GPM (115-230-360-475 LPM)
- Standard operating pressure at 100 psi (7 bar), optional 85 psi (6 bar) or 75 psi (5 bar)
- Optional 2-1/2" inlet size

366E **1-1/2" Selectable Gallonage Foam Nozzle**

366E-TO **1-1/2" Selectable Gallonage Foam Nozzle Tip Only**

366E-BC **1-1/2" Selectable Gallonage Foam Nozzle**

- Industrial nozzle
- Brass construction

366E-BCTO **1-1/2" Selectable Gallonage Foam Nozzle Tip Only**

- Brass construction



Style 366E



Style 366E-TO



Style 366E-BC



Style 366E-BCTO

Style	Inlet Size	Length	Weight Lbs(kg)	Flow Settings	
				GPM	LPM
366E	1-1/2"(38mm)	10" to 12.5" (256mm-316mm)	4.6(2.1kg)	30-60-95-125	115-230-360-475
366E-TO	1-1/2"(38mm)	6.3" to 8.7" (160mm-220mm)	3.1 (1.4kg)	30-60-95-125	115-230-360-475
366E-BC	1-1/2"(38mm)	10" to 12.5" (256mm-316mm)	8.8(4kg)	30-60-95-125	115-230-360-475
366E-BCTO	1-1/2"(38mm)	6.3" to 8.7" (160mm-220mm)	6.4(2.9kg)	30-60-95-125	115-230-360-475



RETRACTABLE FOAM NOZZLES

372E-Series Constant Gallonage Foam Nozzle

- Combination pattern nozzle with versatile multiple flow settings
- Ability to instantly aspirate foam by sliding inbuilt sleeve forward
- No foam aeration tube required for aspiration foam
- Stainless steel spinning teeth for superior fog pattern
- 60, 95 or 125 GPM (230, 360 or 475 LPM)
- Standard operating pressure at 100 psi (7 bar), optional 85 psi (6 bar) or 75 psi (5 bar)
- Optional 2-1/2" inlet size

372E **1-1/2" Selectable Gallonage Foam Nozzle**

372E-TO **1-1/2" Selectable Gallonage Foam Nozzle Tip Only**

372E-BC **1-1/2" Selectable Gallonage Foam Nozzle**

- Industrial nozzle
- Brass construction

372E-BCTO **1-1/2" Selectable Gallonage Foam Nozzle Tip Only**

- Brass construction



Style 372E



Style 372E-TO



Style 372E-BC



Style 372E-BCTO

Style	Inlet Size	Length	Weight Lbs(kg)	Flow Settings	
				GPM	LPM
372E	1-1/2"(38mm)	8.3" to 11.4" (210mm-290mm)	4.4 (2kg)	60, 95 or 125	230, 360 or 475
372E-TO	1-1/2"(38mm)	5.5" to 8.8" (140mm-225mm)	2.9 (1.3kg)	60, 95 or 125	230, 360 or 475
372E-BC	1-1/2"(38mm)	8.3" to 11.4" (210mm-290mm)	8.8 (4kg)	60, 95 or 125	230, 360 or 475
372E-BCTO	1-1/2"(38mm)	5.5" to 8.8" (140mm-225mm)	5.5 (2.5kg)	60, 95 or 125	230, 360 or 475



Self-Educting Nozzle

236 Self-Educting Nozzle

- Inbuilt eductor draws in foam concentrate as water passes through the nozzle
- Easy to use and quick to set up as any fire water stream becomes foam enhanced
- Can be operated efficiently by a single fire fighter, freeing up additional personnel
- Variable pattern control from straight stream to fog pattern
- Suitable for various foam types: AFFF, AR/AFFF, Class A and Haz Mat foams
- Operates effectively as low as 50 psi (3.5 bar)
- 95 GPM at 200 psi is the ideal setting for foam application
- Complete with 6-1/2' pickup hose and 15" stainless steel tube
- Optional Style 212 foam tube



Style	Inlet Size	Flow Rate	Foam Proportioning	Effective Reach	Weight Lbs (kg)
236	1-1/2" (38mm) or 2-1/2" (65mm)	95GPM (360LPM)	3%	120 Feet (36m)	8.1 (3.7kg)



FOAM NOZZLES

High Pressure Self-Educting Nozzle

204 High Pressure Self-Educting Nozzle

- Self-educting for ease of use with foam application
- Easy to use and quick to set up
- Additional pistol grip for excellent control
- Trigger shutoff automatically shuts off flow when released
- No more than 2 seconds to connect the foam unit to pistol
- By changing only the reservoir, foam-unit can be used for different purposes, e.g. cleaning up an oil trail
- 12 GPM at 100 psi working pressure is the ideal setting for foam application
- Foam application rate at the ideal setting is 1 litre per 45 seconds
- 2- litre foam concentrate container
- Combination of Style 306 and foam expansion tube with container

Foam expansion tube

Foam concentrate container

High pressure trigger shutoff



Style 204

Style	Inlet Size	Flow Rate	Foam Proportioning	Weight Lbs (kg)
204	1"NST or BSP	12 GPM (45 LPM)	3%	7.4 (3.4 kg)

Dual-Flow Foam Nozzle

- Selectable dual-flow design with 60 GPM (230 LPM) and 125 GPM (475 LPM)
- Adjust flows by turning the flow selection ring
- Trigger shutoff automatically shuts off flow when released (optional ball valve)
- Foam dispersion jaws enable change of foam application pattern
- Stainless steel air aspirating expansion tube and foam dispersion jaws
- Additional pistol grip for excellent control



Style 238

238 Dual-Flow Foam Nozzle

- Expansion rate of up to 15:1 with AFFF
- Optional 2-1/2" inlet

Style	Inlet Size	Length	Weight Lbs(kg)	Flow Settings	
				GPM	LPM
238	1-1/2" (38mm)	22.8" (580mm)	9.5 (4.3kg)	60 and 125	230 and 475

Flow Rate (LPM)	Pressure	Foam Expansion Rate	Flat Fan Spray Footprint	Range (Meters)
230 LPM	7 BAR	1 : 15	10M × 5M	16
475 LPM	7 BAR	1 : 15	12M × 5M	16



Dual-Agent Nozzles

- Designed to discharge water/AFFF and dry chemical extinguishing agent, separately or at the same time
- Adjacent nozzles mounted on a single pistol grip enhance flexibility and control
- The water/AFFF nozzle has a ball valve control with optional flows of 60 GPM or 95 GPM (both at 100 psi)
- The dry chemical nozzle is designed for an application rate of 5 lbs per second
- Hardcoat anodized aluminium construction for resistance to corrosion and wear and tear
- The discharge end of dry chemical nozzle is equipped with straightening fin for maximum reach

277 1" Dual-Agent Nozzle

- 60 GPM at 100 psi
- Optional 1" or 1-1/2" inlet size

279 1-1/2" Dual-Agent Nozzle

- 60, 95 or 125 GPM at 100 psi
- 1-1/2" inlet size



Style 277 or 279

Style	Flow (AFFF / Water) At 100 PSI	Range (AFFF / Water) At 100 PSI	Water Inlet	Dry Chemical Inlet	Dry Chemical Discharge
277	60 GPM	105 Feet	1" or 1-1/2"	1" NPT	5 Lbs / Sec
279	60, 95 or 125 GPM	120 Feet	1-1/2"	1" NPT	5 Lbs / Sec

Dry Chemical Nozzle

280 Dry Chemical Nozzle

- Slide valve control
- 5 lbs per second application rate
- Effective reach of 20m (65 feet)
- Designed to withstand the abrasive impact of the dry chemical agent
- Optional 1" or 1-1/2" inlet size



Style 280

Style	Inlet Size	Length	Weight Lbs(kg)	Dry Chemical Discharge
280	1" or 1-1/2"	7.8" (200mm)	2.2 (1.0kg)	5 Lbs / Sec



FOAM AERATION TUBES

Foam Aeration Tubes

- Designed for quick and easy attachment to Protek's handline nozzles
- Enhanced foam quality and stability
- Compatible with many foam concentrates
- Expansion rates of up to 12:1
- Weight: 2.6 lbs (1.2 kg)
- Use the table below to determine the proper nozzle/foam tube configuration



Foam Aeration Tubes	Compatible Handline Nozzles*							
	Selectable Gallonage	EN Selectable Gallonage	Multi-Purpose	Multi-Mode	Automatic	Constant Gallonage	High Pressure	Self-Educting
208	350, 352			325				
209	355, 356, 357			326				
210	360, 360-BC, 361, 361-F, 362	2360, 2361						
211	307, 360-BA					371	302, 303	
212	366-BA		332		310, 311	372, 372-BC, 372-BA		236
213	320, 366, 366-BI, 366-BC, 366-F, 366-K, 366-L, 379	2365, 2366				372-F		
214	367-BA, 368-BA, 369-BA, 368-TP, 368-BCTP		333		312	373, 373-BC, 373-BA, 374, 374-BC, 374-TP, 374-BCTP		
215	367, 367-BC, 368, 368-BC, 369,							
216					321, 322, 322-SP			
217					314, 314-TP	375		
218					323, 323-DP			
219					324, 324-TP			
220	390	2368, 2368-TP						

* Abovementioned foam tubes are compatible with Protek nozzles only. Contact our Sales Department for foam tubes that are compatible with OEM nozzles.

Medium Expansion Foam Aeration Tubes

- Compact, lightweight and rugged design
- Stainless steel construction for long-lasting service life
- Designed for quick and easy attachment to Protek's handline nozzles
- Produces a thick foam blanket with the nozzle pattern in a wide fog position
- Produces a higher expansion foam for better reach with a straight stream pattern
- Wide expansion ratios of up to 50:1
- Maximum flow: 250 GPM (950 LPM)
- Maximum pressure: 100 psi (7 bar)
- Weight: 3 lbs (1.5 kg)
- Length: 9"; Diameter: 6"



Style 225, 226, 227

Shown with Style 366 nozzle

Foam Aeration Tubes	Compatible Handline Nozzles		
	Selectable Gallonage	En Selectable Gallonage	Constant Gallonage
225	360, 360-BC, 360-BA, 361, 361-F, 362	2360, 2361	
226	366, 366-BI, 366-BC, 366-F, 366-K, 366-L, 379	2365, 2366	372-F
227	367, 367-BC, 367-BA, 368, 368-BC, 368-BA, 369, 369-BA	2368	



* Abovementioned foam tubes are compatible with Protek nozzles only. Contact our Sales Department for foam tubes that are compatible with OEM nozzles.



Ball Shutoffs & Playpipes

- Provides versatile combination with Protek's nozzle tips and various smooth bore tips
- Designed and constructed for rugged use and reliable performance
- Lightweight alloy or brass construction
- Available inlet size for shutoff: 1" (25 mm), 1-1/2" (38 mm) or 2-1/2" (65 mm)
- Waterway for shutoff are available in 3/4" (19 mm), 1" (25 mm), 1-3/8" (35 mm) or 1-1/2" (38 mm)
- Pistol grip mounted below the valve of ball shutoff
- Playpipe is available with or without shutoff

100 Ball Shutoff

- Lightweight alloy
- 3/4" (19 mm) waterway
- 1" (25 mm) swivel female inlet x 1" (25 mm) male outlet

Style 100



101 Ball Shutoff

- Lightweight alloy
- 1" (25 mm) waterway
- 1-1/2" (38 mm) swivel female inlet x 1-1/2" (38 mm) male outlet

Style 101



101-BC Ball Shutoff

- Brass construction
- 1" (25 mm) waterway
- 1-1/2" (38 mm) swivel female inlet x 1-1/2" (38 mm) male outlet

Style 101-BC



102 Ball Shutoff

- Lightweight alloy
- 1-3/8" (35 mm) waterway
- 1-1/2" (38 mm) or 2-1/2" (65 mm) swivel female inlet x 1-1/2" (38 mm) male outlet

Style 102



Style	Length	Weight Lbs(kg)	Threads		Waterway Size	Pistol Grip
			Inlet Female	Outlet Male		
100	5.1" (130mm)	1.5 (0.7kg)	1" (25mm)	1" (25mm)	3/4" (19mm)	YES
101	6.7" (170mm)	2.2 (1kg)	1-1/2" (38mm)	1-1/2" (38mm)	1" (25mm)	YES
101-BC	6.7" (170mm)	4.8 (2.2kg)	1-1/2" (38mm)	1-1/2" (38mm)	1" (25mm)	YES
102	6.7" (170mm)	3 (1.4kg)	1-1/2" or 2-1/2" (38mm or 65mm)	1-1/2" (38mm)	1-3/8" (25mm)	YES



BALL SHUTOFFS & PLAYPIPES

102-BC Ball Shutoff

- Brass construction
- 1-3/8" (35 mm) waterway
- 1-1/2" (38 mm) or 2-1/2" (65 mm) swivel female inlet x 1-1/2" (38 mm) male outlet



Style 102-BC

103 Ball Shutoff

- Lightweight alloy
- 1-1/2" (38 mm) waterway
- 2-1/2" (65 mm) swivel female inlet x 1-1/2" (38 mm) male outlet



Style 103



Style 104

104 Trigger Shutoff

- Lightweight alloy
- 1" (25mm) swivel female inlet x 1" (25mm) male outlet

Style	Length	Weight Lbs (kg)	Threads		Waterway Size	Pistol Grip
			Inlet Female	Outlet Male		
102-BC	6.7" (170mm)	6.4 (2.9kg)	1-1/2" or 2-1/2" (38mm or 65mm)	1-1/2" (38mm)	1-3/8" (35mm)	YES
103	7.8" (200mm)	4.2 (1.9kg)	2-1/2" (65mm)	1-1/2" (38mm)	1-1/2" (38mm)	YES
104	8.3" (210mm)	2.6 (1.2kg)	1" (25mm)	1" (25mm)	n/a	YES

130 Playpipe

- Lightweight alloy
- 1-3/8" (35 mm) shutoff waterway
- 2-1/2" (65 mm) swivel female inlet x 1-1/2" (38 mm) male outlet

Style 130



130-BC Playpipe

- Brass construction



Style 130-BC

132 Playpipe

- Lightweight alloy
- No shutoff
- 2-1/2" (65 mm) swivel female inlet x 1-1/2" (38 mm) male outlet



Style 132

Style	Length	Weight Lbs (kg)	Threads		Waterway Size
			Inlet Female	Outlet Male	
130	10.2" (260mm)	6.1 (2.8kg)	2-1/2" (65mm)	1-1/2" (38mm)	1-3/8" (35mm)
130-BC	10.2" (260mm)	12.5 (5.6kg)	2-1/2" (65mm)	1-1/2" (38mm)	1-3/8" (35mm)
132	10.2" (259mm)	4.4 (2kg)	2-1/2" (65mm)	1-1/2" (38mm)	1-3/8" (35mm)



Smooth Bore Tips

- Protek's smooth bore tips produce concentrated water flow for maximum reach
- Compatible with Protek's handline nozzles and monitors
- Wide range of discharge sizes to suit all needs
- Lightweight hardcoat anodized aluminium
- Stacked tips provide up to four orifices for customised smooth bore
- Easy-to-read discharge sizes that are laser engraved on the tips

105 Handline Tip
 • 1-1/2" base thread x 1-1/2" outlet thread

106 Plain Tip
 • 1-1/2" inlet

112 Dual Stacked Tips
 • 1-1/2" inlet

115 Triple Stacked Tips
 • 1-1/2" inlet

117 Plain Deluge Tip
 • 2-1/2" inlet

118 Quad Stacked Tips
 • 2-1/2" inlet

120 Quad Stacked Tips
 • 2-1/2" inlet

121 Quad Stacked Tips
 • Stream shaper
 • 3-1/2" inlet



Style	Length	Weight Lbs(kg)	Orifices		Thread Sizes		
			Standard	Optional	Base	Middle	Tip
105	3" (76mm)	0.7 (0.3)	7/8" (22mm)	1/2", 5/8", 3/4", 15/16", 1", 1-1/8" (13, 16, 19, 24, 25, 28mm)	1-1/2" (38mm)		1-1/2" (38mm)
106	5" (127mm)	0.7 (0.3)	1-3/8" (35mm)	3/4", 7/8", 1", 1-1/8", 1-1/4" (19, 22, 25, 28, 32mm)	1-1/2" (38mm)		
112	6.5" (165mm)	0.7 (0.3)	15/16" x 1/2" or 1-1/8" x 1/2" (23x13 or 28x13mm)		1-1/2" (38mm)		1" (25mm)
115	8" (203mm)	0.7 (0.3)	1" x 1-1/8" x 1-1/4" (25x28x32mm)		1-1/2" (38mm)	1-1/2" (38mm)	1-1/4" (32mm)
117	9" (229mm)	1.3 (0.6)	1-1/2" (38mm)	1-1/4", 1-3/8", 1-3/4", 2", 2-1/4" (32, 35, 44, 51, 57mm)	2-1/2" (65mm)		
118	12.8" (325mm)	1.7 (0.8)	1" x 1-1/8" x 1-1/4" x 1-1/2" (25x28x32x38mm)		2-1/2" (65mm)	2" (50mm)	1-1/2" (38mm)
120	12.8" (325mm)	1.7 (0.8)	1-3/8" x 1-1/2" x 1-3/4" x 2" (35x38x44x50mm)		2-1/2" (65mm)	2" (50mm)	1-1/2" (38mm)
121	17.3"~21.7" (440mm~551mm)	1.7 (0.8)	2-1/8" X 2-1/2" X 2-3/4" X 3" (53 x 65 x 69 x 75mm)		3-1/2" (90mm)	2-3/4" (69mm)	2-1/8" (53mm)



SHUTOFFS WITH TIPS

Shutoff with Tips

155 Shutoff with Tip

- Combination of Style 105 handline tip and Style 102 shutoff (see page 35)
- Shutoff waterway: 1-3/8"
- Orifice size: standard 7/8" and optional 1/2", 3/4", 15/16", 1" or 1-1/8"
- 1-1/2" female inlet x 1-1/2" male outlet



Style 155

162 Shutoff with Dual Stacked Tip

- Combination of Style 112 dual stacked tips and Style 101 shutoff (see page 35)
- Shutoff waterway: 1"
- Orifice size: 15/16" x 1/2"
- 1-1/2" inlet



Style 162

176 Shutoff with Tip

- Combination of Style 106 plain tip and Style 102 shutoff (see page 35)
- Shutoff waterway: 1-3/8"
- Orifice size: 1-3/8"
- 1-1/2" or 2-1/2" inlet



Style 176

178 Playpipe with Stacked Tip

- Combination of Style 115 triple stacked tips and Style 130 playpipe (see page 36)
- Shutoff waterway: 1-3/8"
- Orifice size: 1" x 1-1/8" x 1-1/4"
- 2-1/2" inlet



Style 178

182 Playpipe with Stacked Tip

- Combination of Style 115 tips, Style 102 shutoff (no pistol grip) and Style 132 playpipe (see page 36)
- Shutoff waterway: 1-3/8"
- Orifice size: 1" x 1-1/8" x 1-1/4"
- 2-1/2" inlet



Style 182

Style	Length	Weight Lbs(kg)	Orifices	Inlet Size	Shutoff Waterway Size
155	9.8" (249mm)	3.7 (1.7kg)	7/8" (standard) (22mm)	1-1/2" (38mm)	1-3/8" (35mm)
162	11.4" (290mm)	3.7 (1.7kg)	15/16" x 1/2" (24x13mm)	1-1/2" (38mm)	1" (25mm)
176	10.2" (259mm)	3.5 (1.6kg)	1-3/8" (35mm)	1-1/2" or 2-1/2" (38mm or 65mm)	1-3/8" (35mm)
178	13.4" (340mm)	7 (3.2kg)	1" x 1-1/8" x 1-1/4" (25x28x32mm)	2-1/2" (65mm)	1-3/8" (35mm)
182	23.6" (599mm)	8.4 (3.8kg)	1" x 1-1/8" x 1-1/4" (25x28x32mm)	2-1/2" (65mm)	1-3/8" (35mm)



Nozzle Accessories

111 Stream Shaper for Handline Nozzles

- Inbuilt vanes keep flow laminar
- Improves reach and straight jet performance
- 1-1/2" female inlet x 1-1/2" male outlet



Style 111



Style 129

129 Pistol Grip Adapter

- 1-1/2" inlet x 1-1/2" outlet

191 Folding Coupling Spanner

- Lightweight and compact
- Fits Storz, rocker/lug pin coupling



Style 191



Style 133

135 British Instantaneous Adapter

- BI male (1-1/2") x 1-1/2" male thread
- Hardcoat anodized lightweight alloy
- Internally profiled for reduced turbulence

133 British Instantaneous Adapter

- BI male (2-1/2") x 1-1/2" male thread
- Hardcoat anodized lightweight alloy
- Internally profiled for reduced turbulence

133-BC British Instantaneous Adapter

- BI male (2-1/2") x 1-1/2" male thread
- Brass construction
- Internally profiled for reduced turbulence



Style 139



Style 150

137 British Instantaneous Adapter

- BI male (2-1/2") x 2-1/2" male thread
- Hardcoat anodized lightweight alloy
- Internally profiled for reduced turbulence

139 Machino Adapter

- 1-1/2", 2" or 2-1/2" Machino x 1-1/2" or 2-1/2" male thread

150 Flexible Joint

- Improves nozzle handling
- Easy to move from stiff hose line
- 1-1/2" inlet x 1-1/2" outlet

Style	Inlet	Outlet
111	1-1/2" Female	1-1/2" Male
129	1-1/2" Female	1-1/2" Male
135	1-1/2" Male	1-1/2" Male
133	2-1/2" Male	1-1/2" Male
133-BC	2-1/2" Male	1-1/2" Male
137	2-1/2" Male	2-1/2" Male
139	1-1/2" Female	1-1/2" Male
	2" Female	1-1/2" Male
	2-1/2" Female	2-1/2" Male
150	1-1/2" Female	1-1/2" Male



NOZZLE BASE & TEETH, PISTOL GRIPS & HANDLES

Optional Nozzle Base & Teeth

- A range of optional nozzle base are available on request
- Standard NST swivel base in 1" (25 mm), 1-1/2" (38 mm) and 2-1/2" (65 mm)
- British Instantaneous connector in 1-1/2" (38 mm) and 2-1/2" (65 mm)
- BSP threaded male or female Storz adapter in 1-1/2" (38 mm) and 2-1/2" (65 mm)
- Japanese Machino adapters
- Optional nozzle teeth are available on request
- Stainless steel spinning teeth with retaining ring across most models
- Optional one-piece moulded fixed teeth ring

**British Instantaneous****Storz****Machino****Spinning or fixed teeth****Pistol Grips & Handles**

- Colour code your nozzles
- Eight colours are available for shutoff handles and pistol grips on most Protek nozzles at no extra charge
- Simply specify your colour preference at the time of ordering or order separately for easy retrofitting
- Available colours are: blue, green, white, black, orange, red, grey and yellow
- Unless specified at the time of ordering, nozzles will be shipped with black handles and pistol grips

Available colours:

- Blue
- Orange
- Green
- Red
- White
- Gray
- Black
- Yellow



Unless specified at the time of ordering, nozzles will be shipped with black handles and pistol grips



Wildland/Forestry Nozzles

Protek's Wildland/Forestry Nozzles are designed for the rugged simplicity required in wildland/forestry applications. These are combination pattern nozzles with selectable flow settings, ensuring reliable performance in the open environment. Nozzles are small, lightweight and very easy to operate.

307 Wildland/Forestry Nozzle

- Combination pattern nozzle with variable flow setting: 8-15-30 GPM (30-60-115 LPM)
- Easy to operate with a-quarter turn from straight stream to fog at any flow setting
- Simple twist action controls flow setting and shut off
- NFPA compliant



Style 307

Style	Inlet Size	Length	Weight Lbs (kg)	Flow Settings	
				GPM	LPM
307	1" (25mm)	5.5" (140mm)	1.5 (0.7kg)	8-15-30	30-60-115

309 Wildland/Forestry Nozzle

- Easy to use and rugged design
- Combination pattern nozzle with adjustable dual flow setting: 10-30 GPM (37-115 LPM)
- Simple twist operation enables the following settings:
 1. Off
 2. Low-flow straight stream
 3. Low-flow narrow fog
 4. High-flow straight stream
 5. High-flow fog



Style 309



Style	Inlet Size	Length	Weight Lbs (kg)	Flow Settings	
				GPM	LPM
309	1" (25mm)	3.5" (89mm)	0.7 (0.3kg)	10-30	37-115



MARINE NOZZLES

Marine Nozzles

Protek's Marine Nozzles are specifically designed and manufactured for fire fighting in the harsh corrosive marine environment. These nozzles meet the stringent performance requirements of the US Coast Guard. Nozzles are also suitable for use in the shipping industry, refineries, chemical complexes and offshore drilling/production rigs. All Protek Marine Nozzles are ideal for AFFF applications.

366-BC Shipboard Selectable Gallonage Nozzle

- Rugged, corrosion resistant, brass construction
- 30-60-95-125 GPM (115-230-360-475 LPM)
- Optional 2-1/2" inlet
- 100 psi (7 bar) standard, 75 psi (5 & 6 bar) optional
- Compatible with Foam Tube Style 213 (see page 24)



Style 366-BC

366-BCSP Shipboard Selectable Gallonage Nozzle

- 366-BC nozzle with lockable flow rate functionality



Style 366-BCSP
Lockable flow Rate

372-BC 1-1/2" Shipboard Constant Gallonage Nozzle

- Rugged, corrosion resistant, brass construction
- 60, 95 or 125 GPM (230, 360 or 475 LPM)
- Optional 2-1/2" inlet
- Flow setting at 100 psi (7 bar) operating pressure
- Compatible with Foam Tube Style 212 (see page 24)



Style 372-BC

374-BC 2-1/2" Shipboard Constant Gallonage Nozzle

- Rugged, corrosion resistant, brass construction
- 150, 175, 200 or 250 GPM (550, 660, 750 or 950 LPM)
- Optional 1-1/2" inlet
- Flow setting at 100 psi (7 bar) operating pressure
- Compatible with Foam Tube Style 214 (see page 24)



Style 374-BC

Style	Inlet Size	Length	Weight Lbs (kg)	Flow Settings	
				GPM	LPM
366-BC	1-1/2" (38mm)	9" (228mm)	8.3 (3.7kg)	30-60-95-125	115-230-360-475
366-BCSP	1-1/2" (38mm)	9" (228mm)	8.3 (3.7kg)	30-60-95-125	115-230-360-475
372-BC	1-1/2" (38mm)	8.5" (216mm)	7.5 (3.4kg)	60, 95 or 125	230, 360 or 475
374-BC	2-1/2" (65mm)	11" (279mm)	14.7 (6.7kg)	150, 175, 200 or 250	550, 660, 750 or 950



Marine Nozzles

382 Coast Guard Nozzle with Fog Tip

- Brass construction for corrosion resistance
- Meets US Coast Guard specifications for fighting fires with drafted water
- US Coast Guard Approval Number: 162.027/18/0
- Combination of fog and straight stream
- 50 GPM (210 LPM) at orifice size of 5/8"
- Non-clogging design



Style 382

385 4' Coast Guard Applicator with Fog Heads

- 4' long with 60° bend
- Meets Coast Guard specifications

386 6' Coast Guard Applicator with Fog Heads

- 6' long with 60° bend
- Meets Coast Guard specifications



Style 386

Style	Inlet Size	Length	Weight Lbs (kg)	Orifice	Flow Settings	
					GPM	LPM
382	1-1/2" (38mm)	9.4" (239mm)	7.9 (3.5kg)	5/8"	55	208
385	Quick Connection	4' (1219mm)	5 (2.2kg)	n/a	54	204
386	Quick Connection	6' (1828mm)	6 (2.7kg)	n/a	54	204



SPECIALITY NOZZLES

Flashover Nozzle**320 Flashover Nozzle**

- Designed for flashover operation
- Durable valve design suitable for quick continuous open/close operation
- One click to flashover position
- Raised lug on the bumper for flashover fog pattern identification
- Combination pattern nozzle with multiple flow settings
- 30-60-95-125 GPM (115-230-360-475 LPM)
- Compatible with Foam Tube Style 213 (see page 34)



Style 320

Style	Inlet Size	Length	Weight Lbs (kg)	Flow Settings	
				GPM	LPM
320	1-1/2" (38mm)	9.3" (236mm)	3.5 (1.6kg)	30-60-95-125	115-230-360-475

Electric Nozzle**379 Electric Nozzle**

- Designed for use in Class C Hazards
- Safe to use at a distance greater than 10' from electrical equipment
- Designed to produce either wide or narrow fog settings only
- Multiple flow settings
- 30-60-95-125 GPM (115-230-360-475 LPM)
- Compatible with Foam Tube Style 213 (see page 34)



Style 379

Style	Inlet Size	Length	Weight Lbs (kg)	Flow Settings	
				GPM	LPM
379	1-1/2" (38mm)	9" (228mm)	3.9 (1.7kg)	30-60-95-125	115-230-360-475

Deicing Nozzle**392 Deicing Nozzle**

- Metal ball and heat resistant EPDM seats
- Suitable for Type 1 and Type 4 deicing fluids
- Low turbulence design
- Flushing capability
- 13-25-40-60 GPM (50-100-150-230 LPM)



Style 392

Style	Inlet Size	Length	Weight Lbs (kg)	Flow Settings	
				GPM	LPM
392	1" (25mm)	7.4" (190mm)	2.3 (1.1kg)	13-25-40-60	50-100-150-230



Piercing Applicators

308-3, 308-6 Piercing Applicators

- Designed to efficiently extinguish fire in confined and hard-to-reach areas, such as storage facilities, attics, basements and mobile homes
- Quick penetration of glass, crevice in masonry walls, concrete blocks, metal sheets and plywood
- Provides rapid attack on hidden trouble spots
- Hardened tool steel point
- Impinging jets for a dense fog pattern
- 125 GPM (475 LPM)
- Compatible with Class A and Class B foam application
- Available in 3' or 6' lengths



Style	Inlet Size	Length	Weight Lbs (kg)	Flow Settings	
				GPM	LPM
308-3	1-1/2" (38mm)	37" (940mm)	10.1 (4.6kg)	125	475
308-6	1-1/2" (38mm)	72.4" (1838mm)	15.8 (7.2kg)	125	475

Industrial Fog Nozzle

814 Industrial Fog Nozzle

- Heavy-duty inexpensive combination pattern nozzle
- Suitable for industrial settings, such as refineries, chemical plants and office complexes
- Twist shutoff
- 95 GPM (360 LPM)



Style 814

Style	Inlet Size	Length	Weight Lbs (kg)	Flow Settings	
				GPM	LPM
814	1-1/2" (38mm)	3.3" (84mm)	1.6 (0.7kg)	95	360



SELECTABLE GALLONAGE MONITOR NOZZLES

Protek's Selectable Gallonage Monitor Nozzles are combination pattern, master stream nozzles with four distinct, calibrated and selectable flow settings. The nozzles allow fire fighters to switch from smooth bore reach and penetration to fog stream cooling and protection without having to shutdown the water flow to switch tips. The versatile flow setting reduces the risk of injury from manually changing tips on the deck. All nozzles are compatible with Protek's wide range of monitors.

Features:

- Selectable flow rate, changeable even during flowing conditions
- Combination of straight stream and variable fog patterns
- Spinning teeth produce dense, wide, fully adjustable fog pattern
- Heavy-duty protective rubber bumper
- Low maintenance components

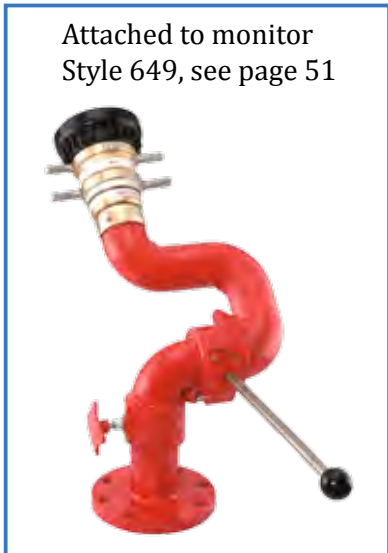
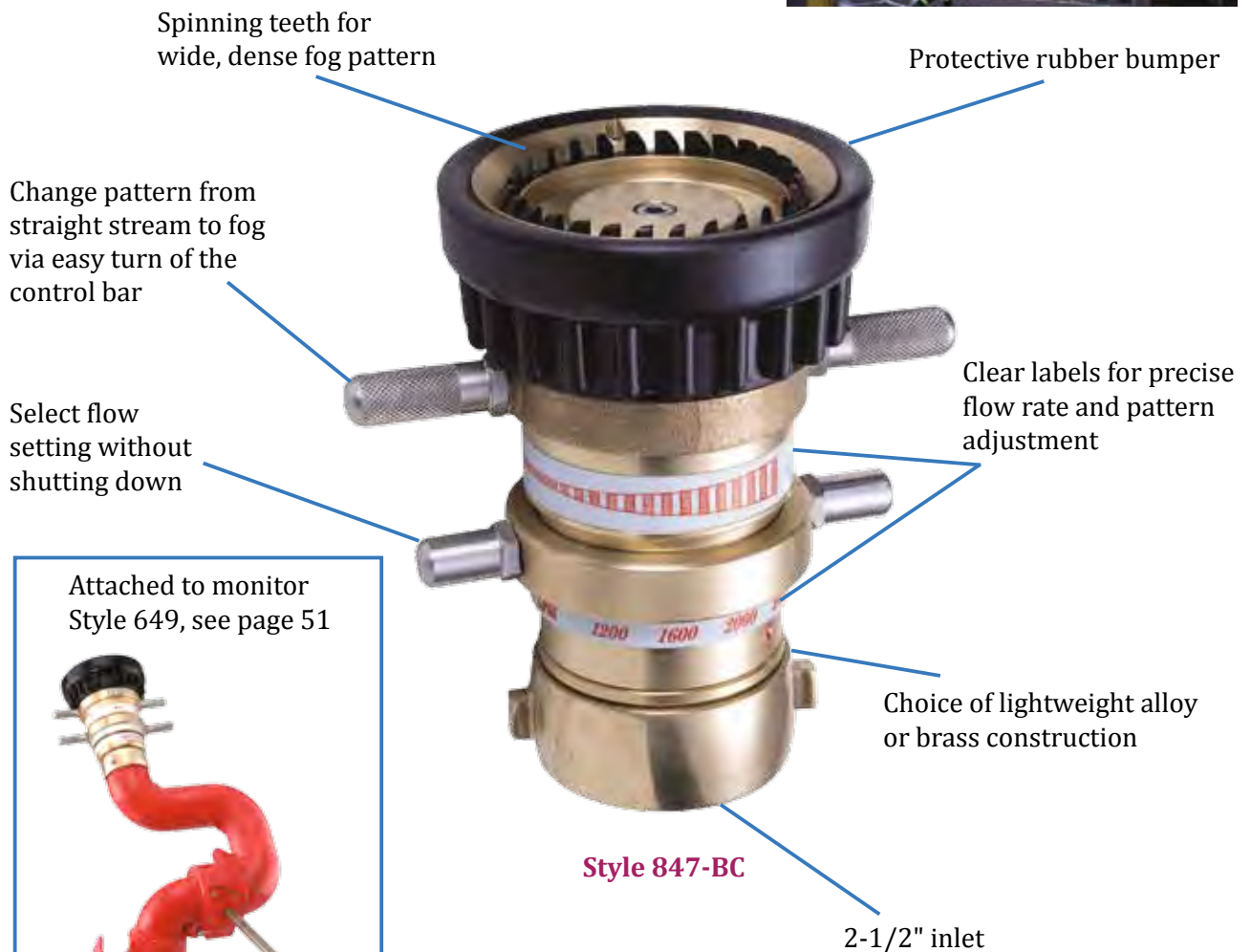

SELECTABLE GALLONAGE MONITOR NOZZLES

846-Series Selectable Gallonage Monitor Nozzles

846, 846-BC Selectable Gallonage Monitor Nozzles

- 250-400-550-750 GPM (950-1600-2000-2900 LPM)
- Optional 500-1000-1500-2000 LPM
- Change flow setting without shutting down
- Available in lightweight alloy or brass construction



Style 846



Style 846-BC

847-Series Selectable Gallonage Monitor Nozzles

847, 847-BC Selectable Gallonage Monitor Nozzles

- 300-400-500-600 GPM (1200-1600-2000-2400 LPM)
- Change flow setting without shutting down
- Available in lightweight alloy or brass construction



Style 847



Style 847-BC

848-Series Selectable Gallonage Monitor Nozzles

848, 848-BC Selectable Gallonage Monitor Nozzles

- 500-750-1000-1250 GPM (1900-2900-3800-4800 LPM)
- Change flow setting without shutting down
- Available in lightweight alloy or brass construction



Style 848



Style 848-BC

849-Series Selectable Gallonage Monitor Nozzles

849, 849-BC Selectable Gallonage Monitor Nozzles

- 350-500-750-1000 GPM (1325-1900-2900-3800 LPM)
- Change flow setting without shutting down
- Available in lightweight alloy or brass construction



Style 849



Style 849-BC

Style	Material	Inlet	Flow @ 100 PSI (7 BAR)		Teeth	Length	Weight Lbs(kg)
			GPM	LPM			
846	Alloy	2-1/2" (65mm)	250-400-550-750	500-1000-1500-2000*	Spinning	9.3" (236mm)	6.6 (3)
846-BC	Brass	2-1/2" (65mm)	250-400-550-750	500-1000-1500-2000*	Spinning	8.3" (211mm)	16 (7.3)
847	Alloy	2-1/2" (65mm)	300-400-500-600	1200-1600-2000-2400	Spinning	8.3" (211mm)	6.6 (3)
847-BC	Brass	2-1/2" (65mm)	300-400-500-600	1200-1600-2000-2400	Spinning	8.3" (211mm)	16 (7.3)
848	Alloy	2-1/2" (65mm)	500-750-1000-1250	1900-2900-3800-4800	Spinning	9.3" (236mm)	8.5 (3.9)
848-BC	Brass	2-1/2" (65mm)	500-750-1000-1250	1900-2900-3800-4800	Spinning	9.3" (236mm)	22 (10)
849	Alloy	2-1/2" (65mm)	350-500-750-1000	1325-1900-2900-3800	Spinning	9.3" (236mm)	8.5 (3.9)
849-BC	Brass	2-1/2" (65mm)	350-500-750-1000	1325-1900-2900-3800	Spinning	9.3" (236mm)	22 (10)

* Flow setting of 950-1600-2000-2900 LPM is available on request



ADJUSTABLE FLOW-BAFFLE MONITOR NOZZLES

Protek's Adjustable Flow-Baffle Monitor Nozzles are combination pattern, master stream nozzles with selectable flow settings. Flow is adjusted by a simple press-turn motion of the outer spring loaded baffle and rotating to the laser etched position for the desired flow. Nozzles must be shut down to change settings. The nozzles have excellent straight stream performance and a wide, dense, fully adjustable fog pattern. All nozzles are compatible with Protek's wide range of monitors.

Features:

- Spring loaded baffle enables flow rate selection
- Combination of straight stream and variable fog patterns
- Straight stream is clean and far-reaching
- Fog pattern is wide, dense and fully adjustable
- Flow and pressure are laser engraved on the baffle
- Low maintenance, high quality components



Spring loaded baffle for easy flow selection



Change pattern from straight stream to fog via an easy turn of the control bar

Choice of lightweight alloy or brass construction



Style 823-BC

2-1/2" inlet
(1-1/2" inlet size available in Style 818, 818-BC, 819, 819-BC, 820, 820-BC)



ADJUSTABLE FLOW-BAFFLE MONITOR NOZZLES

818- and 819-Series Adjustable Flow-Baffle Monitor Nozzles

- Varying flow settings with an easy turn of the baffle
- Spinning teeth
- Optional 2-1/2" inlet size
- Available in lightweight alloy or brass construction

818, 818-BC Adjustable Flow-Baffle Monitor Nozzles

- 15, 30, 45 GPM (56, 115, 170 LPM)

819, 819-BC Adjustable Flow-Baffle Monitor Nozzles

- 60, 95, 125 GPM (230, 360, 475 LPM)



Style 818
Style 819
Style 820

820-Series Adjustable Flow-Baffle Monitor Nozzles

- Varying flow settings with an easy turn of the baffle
- Spinning teeth
- Optional 2-1/2" inlet size
- Available in lightweight alloy or brass construction

820, 820-BC Selectable Gallonage Monitor Nozzles

- 200, 250, 350 GPM (750, 950, 1325 LPM)



Style 818-BC
Style 819-BC
Style 820-BC

Style	Material	Inlet	Flow @ 100 PSI (7 BAR)		Teeth	Length	Weight Lbs(kg)
			GPM	LPM			
818	Alloy	1-1/2" (38 mm)	15, 30, 45	56, 115, 170	Spinning	5.5" (140mm)	2.6 (0.2)
818-BC	Brass	1-1/2" (38 mm)	15, 30, 45	56, 115, 170	Spinning	5.5" (140mm)	7.3 (3.3)
819	Alloy	1-1/2" (38 mm)	60, 95, 125	230, 360, 475	Spinning	5.5" (140mm)	2.6 (1.2)
819-BC	Brass	1-1/2" (38 mm)	60, 95, 125	230, 360, 475	Spinning	5.5" (140mm)	7.3 (3.3)
820	Alloy	1-1/2" (38 mm)	200, 250, 350	750, 950, 1325	Spinning	5.5" (140mm)	2.6 (1.2)
820-BC	Brass	1-1/2" (38 mm)	200, 250, 350	750, 950, 1325	Spinning	5.5" (140mm)	7.3 (3.3)



ADJUSTABLE FLOW-BAFFLE MONITOR NOZZLES

2-1/2" Adjustable Flow-Baffle Monitor Nozzles

- Varying flow settings with an easy turn of the baffle
- Fixed or spinning teeth
- Available in lightweight alloy or brass construction

822, 822-BC Adjustable Flow-Baffle Monitor Nozzles

- 250, 350, 500 GPM (950, 1325, 1900 LPM)
- Fixed teeth
- Inbuilt Stream Shaper for maximum reach



Style 822-BC
Style 823-BC



Style 822
Style 823

823, 823-BC Adjustable Flow-Baffle Monitor Nozzles

- 300, 500, 700 GPM (1140, 1900, 2660 LPM)
- Fixed teeth
- Inbuilt Stream Shaper for maximum reach
- FM approved (Style 823-BC)



Style 845



Style 824

824, 824-BC Adjustable Flow-Baffle Monitor Nozzles

- 250, 350, 500 GPM (950, 1325, 1900 LPM)
- Spinning teeth



Style 845-BC

845, 845-BC Adjustable Flow-Baffle Monitor Nozzles

- 300, 500, 800, 1000 GPM (1140, 1900, 3030, 3800 LPM)
- Spinning teeth

Style	Material	Inlet	Flow @ 100psi (7 bar)		Teeth	Length	Weight Lbs(kg)
			GPM	LPM			
822	Alloy	2-1/2" (65 mm)	250, 350, 500	950, 1325, 1900	Fixed	6.7" (170mm)	4.4 (2)
822-BC	Brass	2-1/2" (65 mm)	250, 350, 500	950, 1325, 1900	Fixed	6.7" (170mm)	12.8 (5.8)
823	Alloy	2-1/2" (65 mm)	300, 500, 700	1140, 1900, 2660	Fixed	6.7" (170mm)	4.4 (2)
823-BC	Brass	2-1/2" (65 mm)	300, 500, 700	1140, 1900, 2660	Fixed	6.7" (170mm)	12.8 (5.8)
824	Alloy	2-1/2" (65 mm)	250, 375, 500	950, 1420, 1900	Spinning	5.9" (150mm)	3.5 (1.6)
824-BC	Brass	2-1/2" (65 mm)	250, 375, 500	950, 1420, 1900	Spinning	5.9" (150mm)	10 (4.6)
845	Alloy	2-1/2" (65 mm)	300, 500, 800, 1000	1140, 1900, 3030, 3800	Spinning	7.8" (198mm)	7.9 (3.6)
845-BC	Brass	2-1/2" (65 mm)	300, 500, 800, 1000	1140, 1900, 3030, 3800	Spinning	7.8" (198mm)	18 (8.2)



830-Series Automatic Monitor Nozzles

- Automatically adjusts to maintain effective stream and maximum reach at variable or reduced flows
- Maintain constant operating pressure over a wide range of flows
- Pattern easily changed from straight stream to fog pattern with large control handle
- Compatible with Protek's wide range of monitors

830 Automatic Monitor Nozzle

- 300-1000 GPM (1140-3800 LPM)
- Lightweight alloy

Style 830



832-Series Automatic Monitor Nozzles

- Automatically adjusts to changes in flow and pressure
- Maintain constant operating pressure over a wide range of flows
- Pattern easily changed from straight stream to fog pattern with large control handle
- Compatible with Protek's wide range of monitors

832 Automatic Monitor Nozzle

- 300-1000 GPM (1140-3800 LPM)
- Lightweight alloy

Style 832



833-Series Automatic Monitor Nozzles

- Automatically adjusts to changes in flow and pressure
- Maintain constant operating pressure over a wide range of flows
- Pattern easily changed from straight stream to fog pattern with large control handle
- Compatible with Protek's wide range of monitors

833 Automatic Monitor Nozzle

- 300-1250 GPM (1140-4750 LPM)
- Lightweight alloy
- Compatible with Stream Shaper 109

Style 833



Style	Material	Inlet	Flow Range		Teeth	Length	Weight Lbs(kg)
			GPM	LPM			
830	Alloy	2-1/2" (65 mm)	300-1000	1140-3800	Fixed	8.2" (208mm)	9.9 (4.5kg)
832	Alloy	2-1/2" (65 mm)	300-1000	1140-3800	Fixed	8.2" (208mm)	9.9 (4.5kg)
833	Alloy	3-1/2" (89 mm)	300-1250	1140-4750	Fixed	8.4" (212mm)	11 (5kg)



CONSTANT GALLONAGE MONITOR NOZZLES

Protek's Constant Gallonage Monitor Nozzles are combination pattern, master stream nozzles with a fixed constant flow. The flow rate is factory preset to customers' specifications. Nozzles have built-in stream shaper designed for maximum reach (Style 825 and 825-BC). Nozzles are adjustable from straight stream to a dense fog pattern. All nozzles are compatible with Protek's wide range of monitors.

- Simple, rugged nozzle with superior stream quality and reach
- Large handle enables easy stream pattern management
- Available in lightweight alloy or corrosion resistant brass construction

825-Series Constant Gallonage Monitor Nozzles

- Twist shutoff
- Inbuilt Stream Shaper for maximum reach

825, 825-BC Constant Gallonage Monitor Nozzles

- 500, 750, 1000, 1250 GPM (1900, 2900, 3800, 4800 LPM)
- 750 GPM is standard



Style 825



Style 825-BC

835-Series Constant Gallonage Monitor Nozzles

- Fixed teeth

835, 835-BC Constant Gallonage Monitor Nozzles

- 750, 1000 GPM (2900, 3800 LPM)
- Single fixed gallonage



Style 835



Style 835-BC

837-Series Constant Gallonage Monitor Nozzles

837-BC Constant Gallonage Monitor Nozzles

- Flows up to 2000 GPM (7600 LPM)
- Single fixed gallonage
- Optional flows of between 1000-2000 GPM in 100 GPM increments
- Compatible with Stream Shaper 109



Style 837-BC

Style	Material	Inlet	Flow @ 100 psi (7 bar)		Length	Weight Lbs(kg)
			GPM	LPM		
825	Alloy	2-1/2" (65 mm)	500, 750, 1000, 1250	1900, 2900, 3800, 4800	9" (229mm)	13 (6)
825-BC	Brass	2-1/2" (65 mm)	500, 750, 1000, 1250	1900, 2900, 3800, 4800	9" (229mm)	23 (10)
835	Alloy	2-1/2" (65 mm)	750, 1000	2900, 3800	7" (178mm)	4.8 (2.2)
835-BC	Brass	2-1/2" (65 mm)	750, 1000	2900, 3800	7" (178mm)	12.5 (5.7)
837-BC	Brass	3-1/2" (89 mm)	2000	7600	11" (279mm)	35 (16)



ELECTRIC MONITOR NOZZLES

Electric Monitor Nozzles

- Electrically operated pattern control for use in remote control applications
- Easily change from solid bore to fog flow streams with a flick of the switch
- Switch from solid bore to fog without shutting down
- Available in either automatic or fixed flow nozzle type
- Spring loaded baffle enables flow rate selection
- Motor (standard 24V or 12V DC on request) totally enclosed and sealed
- Standard manual override when electrical power fails
- Hardcoat anodized aluminium for maximum resistance to corrosion and wear
- Used in conjunction with Protek's remote controlled monitors
- Available in either spinning teeth or fixed teeth

818E Electric Adjustable Flow-Baffle Monitor Nozzle

- 15, 30, 45 GPM (60, 115, 170 LPM)
- 1-1/2" (38 mm) inlet size

819E Electric Adjustable Flow-Baffle Monitor Nozzle

- 60, 95, 125 GPM (230, 360, 475 LPM)
- 1-1/2" (38 mm) inlet size

820E Electric Adjustable Flow-Baffle Monitor Nozzle

- 200, 250, 350 GPM (750, 950, 1325 LPM)
- 1-1/2" (38 mm) inlet size

817E Electric Adjustable Flow-Baffle Monitor Nozzle

- 250, 400, 550, 750 GPM (950, 1525, 2100, 2900 LPM)
- 2-1/2" (65 mm) inlet size

855E Electric Automatic Monitor Nozzle

- 300-1250 GPM (1140-4800 LPM)
- 2-1/2" (65 mm) inlet size



Style 818E, 819E, 820E



Style 817E



Style 855E

Style	Material	Pattern Control	Flow @ 100 psi(7 bar)		Teeth	Inlet	Weight Lbs(kg)
			GPM	LPM			
818E	Alloy	Electric	15, 30, 45	60, 115, 170	Spinning	1-1/2" (38mm)	7 (3.2)
819E	Alloy	Electric	60, 95, 125	230, 360, 475	Spinning	1-1/2" (38mm)	7 (3.2)
820E	Alloy	Electric	200, 250, 350	750, 950, 1325	Spinning	1-1/2" (38mm)	7 (3.2)
817E	Alloy	Electric	250, 400, 550, 750	950, 1525, 2100, 2900	Fixed	2-1/2" (65mm)	8.5 (3.8)
855E	Alloy	Electric	300-1250	1140-4800	Fixed	2-1/2" (65mm)	12 (5.5)



SELF-EDUCTING MONITOR NOZZLES

Self-Educting Monitor Nozzles

- Educt foam at a wide range of flow rates up to 1000 GPM (3800 LPM)
- Transform a water monitor into a foam station without additional equipment
- Designed for use with Class A and B foam
- Combination of straight stream and variable fog patterns
- Interchangeable foam orifice inserts enable variable foam proportioning
- Available in durable lightweight alloy or heavy-duty brass construction
- Optional drum pick up kit comes with 1m rigid PVC tube with shutoff capability and 8' or 9' pickup hose
- Optional isolation valve for shutoff capability

881-Series Self-Educting Monitor Nozzles

- 150 GPM (550 LPM)
- Optional 2-1/2" inlet size
- Metering capability of 3% or 6%
- 9' pickup hose and 15" stainless steel tube
- Available in lightweight alloy or brass construction



881, 881-BC Self-Educting Monitor Nozzles

883-Series Self-Educting Monitor Nozzles

- 225 GPM (850 LPM)
- Optional 2-1/2" inlet size
- Metering rate of 3% or 6%
- 9' pickup hose and 15" stainless steel tube
- Available in lightweight alloy or brass construction



883, 883-BC Self-Educting Monitor Nozzles



9' pickup hose and 15" stainless steel tube

Style	Material	Flow @ 100 psi (7 bar)	Water Inlet	Foam Inlet	Proportioning	Length	Weight Lbs(kg)
881	Alloy	150GPM (550LPM)	1-1/2" (38 mm)	Quick Connection	3%, 6%	6.3" (160mm)	6.6 (3kg)
881-BC	Brass	150GPM (550LPM)	1-1/2" (38 mm)	Quick Connection	3%, 6%	6.3" (160mm)	9.9 (4.5kg)
883	Alloy	225GPM (850LPM)	1-1/2" (38 mm)	Quick Connection	3%, 6%	6.3" (160mm)	6.6 (3kg)
883-BC	Brass	225GPM (850LPM)	1-1/2" (38 mm)	Quick Connection	3%, 6%	6.3" (160mm)	9.9 (4.5kg)



SELF-EDUCTING MONITOR NOZZLES

886-Series Self-Educting Monitor Nozzles

- 350 GPM (1325 LPM)
- 2-1/2" inlet size
- Metering capability of 3% or 6%
- 9' pickup hose and 15" stainless steel tube
- Available in lightweight alloy or brass construction



Style 886



Style 886-BC

886, 886-BC Self-Educting Monitor Nozzles

887-Series Self-Educting Monitor Nozzles

- 500 GPM (1900 LPM)
- 2-1/2" inlet size
- Metering capability of 1% or 3%
- 9' pickup hose and 15" stainless steel tube
- Available in lightweight alloy or brass construction



Style 887



Style 887-BC

887, 887-BC Self-Educting Monitor Nozzles

888-Series Self-Educting Monitor Nozzles

- 350, 500, 750 GPM (1325, 1900, 2900 LPM)
- 2-1/2" inlet size
- Interchangeable orifice plates for various induction rates
- Metering capability of 1/2%, 1%, 3% or 6%
- 8' pickup hose



Style 888



Style 888-BC

888, 888-BC Self-Educting Monitor Nozzles



Orifice Plates for Style 888 and 888-BC

Style	Material	Flow @ 100psi (7 bar)	Water Inlet	Foam Inlet	Proportioning	Length	Weight Lbs(kg)
886	Alloy	350 GPM (1325 LPM)	2-1/2" (65mm)	Quick Connection	3%, 6%	7.1" (180mm)	7.9 (3.6)
886-BC	Brass	350 GPM (1325 LPM)	2-1/2" (65mm)	Quick Connection	3%, 6%	7.1" (180mm)	15 (6.8)
887	Alloy	500 GPM (1900 LPM)	2-1/2" (65mm)	Quick Connection	1%, 3%	7.1" (180mm)	7.9 (3.6)
887-BC	Brass	500 GPM (1900 LPM)	2-1/2" (65mm)	Quick Connection	1%, 3%	7.1" (180mm)	15 (6.8)
888	Alloy	350, 500, 750 (1325, 1900, 2900)	2-1/2" (65mm)	Quick Connection	1/2%, 1%, 3%, 6%	5.7" (145mm)	13.2 (6)
888-BC	Brass	350, 500, 750 (1325, 1900, 2900)	2-1/2" (65mm)	Quick Connection	1/2%, 1%, 3%, 6%	5.7" (145mm)	21.5 (9.8)



SELF-EDUCTING MONITOR NOZZLES & ACCESSORIES

889-Series Self-Educting Monitor Nozzles

- 1000 GPM (3800 LPM)
- 2-1/2" inlet size
- Metering capability of 1% or 3%
- 8' pickup hose
- Available in lightweight alloy or brass construction



Style 889

Style 889-BC

889, 889-BC Self-Educting Monitor Nozzles

Style	Material	Flow @ 100 psi (7 bar)	Water Inlet	Foam Inlet	Proportioning	Length	Weight Lbs(kg)
889	Alloy	1000GPM (3800LPM)	2-1/2" (65mm)	Quick Connection	1%, 3%	9.5" (241mm)	11.8 (5.4)
889-BC	Brass	1000GPM (3800LPM)	2-1/2" (65mm)	Quick Connection	1%, 3%	9.5" (241mm)	18.7 (8.5)

Isolation Valve And Drum Pickup Kit

- Isolation valve comes with 3/4" orifice size for Style 886, 886-BC, 887 and 887-BC or 1-1/4" orifice size for Style 888, 888-BC, 889 and 889-BC
- Drum pickup kit comes with 1 metre rigid PVC tube with shutoff capability and 8' or 9' pickup hose with quick connection coupling



Drum Pickup Kit Isolation Valve

Monitor Foam Aeration Tube

221 Monitor Foam Aeration Tube

- Designed for quick and easy attachment
- Enhances foam quality and stability
- Compatible with Style 822, 822-BC, 823, 823-BC, 886, 886-BC, 887 and 887-BC monitor nozzles



Shown with Style 887 nozzle

Style 221

Stream Shaper

- Used to strengthen water flow
- Features replaceable vanes for easy repair

109 Stream Shaper

- 3-1/2" female inlet x 3-1/2" male outlet

119, 119-BC Stream Shaper

- 2-1/2" female inlet x 2-1/2" male outlet



Style 109



Style 119



Style 119-BC

Style	Material	Inlet	Outlet	Length	Weight Lbs(kg)
109	Alloy	3-1/2" (90mm)	3-1/2" (90mm)	4.9" (125mm)	2.6 (1.2)
119	Alloy	2-1/2" (65mm)	2-1/2" (65mm)	4.2" (107mm)	2.2 (1)
119-BC	Brass	2-1/2" (65mm)	2-1/2" (65mm)	4.2" (107mm)	4.4 (2)



Protek manufactures a wide selection of Monitors that suit every fire ground need from manual to electric monitors. Protek's rugged, lightweight monitors optimise advanced computer aided design and testing technology, offering features such as cast-in vanes for high flow efficiency and minimised flow turbulence. Protek Industrial Monitors are highly manoeuvrable and easy to operate. With performance of up to 2000 GPM (7570 LPM), Protek Monitors offer optimal coverage in industrial, mining and marine environments. Monitors are compatible with Protek diverse range of master stream nozzles.

Features:

- Corrosion resistant brass construction
- Ideal for marine, offshore, industrial and other corrosive environment
- Cast-in turning vanes for efficient flow and minimal friction loss
- Operating pressure of 200 psi (14 bar)
- Double-row stainless steel ball bearings in all rotational joints
- Compact design and low-profile



Style 611 monitor shown with Style 848-BC nozzle



Full 3" waterway

Fully enclosed worm gear protected from the elements

Vertical travel controlled by hand wheel with worm gear

360° continuous horizontal rotation

Double row stainless steel ball bearings at all rotational joints

Style 611

Horizontal twist lock



Compatible with Style 911 Oscillating Flange (page 69)
Readily transforms a manual monitor into an oscillating monitor



INDUSTRIAL MONITORS

Industrial Monitors

- Ideal for marine, offshore, industrial and other corrosive environments
- Corrosion resistant cast brass construction
- Rugged, lightweight and flow-efficient monitors with high reliability and minimal maintenance
- Selection of tiller bar, single hand-wheel and dual hand-wheel monitor controls
- Wide range of monitors with capacity from 500 GPM (1900 LPM), 750 GPM (2900 LPM), 1250 GPM (4800 LPM) to 2000 GPM (7570 LPM)
- Cast-in turning vanes for efficient flow and minimal friction loss for selected models
- Optional stream shaper (Style 119, 119-BC and 109) improves reach and straight jet performance
- Standard unit painted red

605 Industrial Monitor

- Full 2-1/4" waterway for flow rate of up to 500 GPM (1900 LPM)
- Cast-in turning vanes for efficient flow and minimal friction loss
- Full 360° rotation
- Vertical travel of 140° from 80° above and 60° below horizontal
- Positive friction locks with brass knob for both horizontal and vertical travel to hold desired position
- Operating pressure of 200 psi (14 bar)
- Stainless steel lever for durability and easy control



Style 605



Style 605			
Max. GPM (LPM)		500 (1900)	
Inlet	Size	2"	2-1/2" 3"
	Type	Female Thread	Flange
Outlet		1-1/2"	
Control		Tiller Bar	
Material		Brass	
Finish		Red Powder Coating	
Friction Loss		28 psi at 500 gpm	
		15 psi at 350 gpm	
Travel		140° Vertical	
		360° Rotation	
Weight		19 lbs. (9kg)	



611 Industrial Monitor

- Full 3" waterway for flow rate of up to 1250 GPM (4800 LPM)
- Full 360° rotation
- Vertical travel of 140° from 85° above to 55° below horizontal
- Vertical travel is controlled by hand wheel with worm gear
- Fully enclosed worm gear is protected from the elements
- Double-row stainless steel ball bearings in all rotational joints
- Compact design and low-profile
- FM approved



Style 611



Style 611 monitor shown with Style 848-BC nozzle

Style 611			
Max. GPM (LPM)	1250 (4800)		
Inlet	Size	3"	4"
	Type	3"	
Outlet	2-1/2"		
Control	Single Hand-Wheel		
Material	Brass		
Finish	Red Powder Coating		
Friction Loss	26 psi at 1250 gpm		
	18 psi at 1000 gpm		
Travel	140° Vertical		
	360° Rotation		
Weight	56 lbs. (26kg)		
Certification	FM		

612 Industrial Monitor

- Full 3" waterway for flow rate of up to 1250 GPM (4800 LPM)
- Full 360° rotation
- Vertical travel of 140° from 85° above to 55° below horizontal
- Vertical and horizontal travel are controlled by hand wheels with worm gears
- Fully enclosed worm gears are protected from the elements
- Double-row stainless steel ball bearings in all rotational joints
- Compact design and low profile



Style 612



Style 612 monitor shown with Style 848-BC nozzle

Style 612			
Max. GPM (LPM)	1250 (4800)		
Inlet	Size	3"	4"
	Type	3"	
Outlet	2-1/2"		
Control	Dual Hand-Wheel		
Material	Brass		
Finish	Red Powder Coating		
Friction Loss	26 psi at 1250 gpm		
	18 psi at 1000 gpm		
Travel	140° Vertical		
	360° Rotation		
Weight	60 lbs. (27kg)		



INDUSTRIAL MONITORS

636 Industrial Monitor

- Full 2-1/2" waterway for flow rate of up to 750 GPM (2900 LPM)
- Full 360° rotation
- Vertical travel of 135° from 75° above to 60° below horizontal
- Positive friction locks for both horizontal and vertical travel to hold desired position
- Operating pressure of 200 psi (14 bar)
- Stainless steel lever for durability and easy control
- FM approved



Style 636 monitor shown with Style 823-BC nozzle

Style 636				
Max. GPM (LPM)		750 (2900)		
Inlet	Size	3"	4"	6"
	Type	Flange		Female Thread
Outlet		2-1/2"		
Control		Tiller Bar		
Material		Brass		
Finish		Red Powder Coating		
Friction Loss		35 psi at 750 gpm		
		18 psi at 500 gpm		
Travel		135° Vertical		
		360° Rotation		
Weight		44 lbs. (20kg)		
Certification		FM		

648 Industrial Monitor

- Full 3-1/4" waterway for flow rate of up to 1250 GPM (4800 LPM)
- Cast-in turning vanes for efficient flow and minimal friction loss
- Full 360° rotation
- Vertical travel of 135° from 90° above and 45° below horizontal
- Positive friction locks with brass knob for both horizontal and vertical travel to hold desired position
- Operating pressure of 200 psi (14 bar)
- Stainless steel lever for durability and easy control



Style 648 monitor shown with Style 835-BC nozzle

Style 648			
Max. GPM (LPM)		1250 (4800)	
Inlet	Size	3"	4"
	Type	Flange	
Outlet		2-1/2"	
Control		Tiller Bar	
Material		Brass	
Finish		Red Powder Coating	
Friction Loss		13 psi at 1000 gpm	
		20 psi at 1250 gpm	
Travel		135° Vertical	
		360° Rotation	
Weight		52 lbs. (23.5 kg)	



649 Industrial Monitor

- Full 3" waterway for flow rate of up to 1250 GPM (4800 LPM)
- Cast-in turning vanes for efficient flow and minimal friction loss
- Full 360° rotation
- Vertical travel of 150° from 90° above and 60° below horizontal
- Positive friction locks with brass knob for both horizontal and vertical travel to hold desired position
- Operating pressure of 200 psi (14 bar)
- Stainless steel lever for durability and easy control
- FM approved



Style 649				
Max. GPM (LPM)		1250 (4800)		
Inlet	Size	3"	4"	3"
	Type	Flange		Female Thread
Outlet		2-1/2"		
Control		Tiller Bar		
Material		Brass		
Finish		Red Powder Coating		
Friction Loss		18 psi at 1250 gpm		
		15 psi at 1000 gpm		
Travel		150° Vertical		
		360° Rotation		
Weight		56 lbs. (25kg)		
Certification		FM		

736 Industrial Monitor

- Smooth internal waterway for efficient flow
- Seamless brass 2.5" waterway for flow rate of up to 1250 GPM (4800 LPM)
- Full 360° rotation
- Vertical travel of 135° from 90° above and 45° below cast brass swivel joints
- Stainless steel balls in all swivels
- Positive friction locks for both horizontal and vertical travel to hold desired position
- Operating pressure of 200 psi (14 bar)
- Stainless steel lever for durability and easy control
- FM approved



Style 736				
Max. GPM (LPM)		1250 (4800)		
Inlet	Size	3"	4"	6"
	Type	Flange		Female Thread
Outlet		2-1/2"		
Control		Tiller Bar		
Material		Brass		
Finish		Red Powder Coating		
Friction Loss		24 psi at 1250 gpm		
		20 psi at 1000 gpm		
Travel		135° Vertical		
		360° Rotation		
Weight		44 lbs. (20kg)		
Certification		FM		



INDUSTRIAL MONITORS

633 Industrial Monitor

- Full 2-3/4" waterway for flow rate of up to 750 GPM (2900 LPM)
- Cast-in turning vanes for efficient flow and minimal friction loss
- Full 360° rotation
- Vertical travel of 145° from 90° above to 55° below horizontal
- Operating pressure of 200 psi (14 bar)
- Vertical and horizontal travel are controlled by hand wheels with worm gears
- Standard unit painted red



Style 633				
Max. GPM (LPM)	750 (2900)			
Inlet	Size	3"	4"	3"
	Type	Flange		Female Thread
Outlet	2-1/2"			
Control	Dual Hand-Wheel			
Material	Alloy			
Finish	Red Powder Coating			
Friction Loss	6 psi at 500 gpm			
	13 psi at 750 gpm			
Travel	145° Vertical			
	360° Rotation			
Weight	28 lbs. (13kg)			

655 Industrial Monitor

- Full 3-1/4" waterway for flow rate of up to 1250 GPM (4800 LPM)
- Cast-in turning vanes for efficient flow and minimal friction loss
- Full 360° rotation
- Vertical travel of 135° from 90° above and 45° below horizontal
- Operating pressure of 200 psi (14 bar)
- Vertical and horizontal travel are controlled by hand wheels with worm gears



Style 655				
Max. GPM (LPM)	1250 (4800)			
Inlet	Size	3"	4"	
	Type	Flange		
Outlet	2-1/2"			
Control	Dual Hand-Wheel			
Material	Alloy			
Finish	Red Powder Coating			
Friction Loss	13 psi at 1000 gpm			
	20 psi at 1250 gpm			
Travel	135° Vertical			
	360° Rotation			
Weight	28 lbs. (13kg)			



660 Industrial Monitor

- Full 4-1/4" waterway for flow rate of up to 2000 GPM (7570 LPM)
- Cast-in turning vanes for efficient flow and minimal friction loss
- Full 360° rotation
- Vertical travel of 135° from 90° above and 45° below horizontal
- Positive friction locks with brass knob for both horizontal and vertical travel to hold desired position
- Operating pressure of 200 psi (14 bar)
- Stainless steel lever for durability and easy control

Style 660 monitor shown with Style 109 stream shaaper and 121 quad stacked tips



Style 660

Style 660		
Max. GPM (LPM)		2000 (7570)
Inlet	Size	4" 6"
	Type	Flange
Outlet		3-1/2"
Control		Tiller Bar
Material		Brass
Finish		Red Powder Coating
Friction Loss		38 psi at 2000 gpm
		15 psi at 1200 gpm
Travel		135° Vertical
		360° Rotation
Weight		97 lbs. (44kg) to 110 lbs. (50kg)

661 Industrial Monitor

- Full 4-1/4" waterway for flow rate of up to 2000 GPM (7570 LPM)
- Cast-in turning vanes for efficient flow and minimal friction loss
- Full 360° rotation
- Vertical travel of 135° from 90° above to 45° below horizontal
- Vertical and horizontal travel are controlled by hand wheels with worm gears
- Fully enclosed worm gears are protected from the elements
- Double-row stainless steel ball bearings in all rotational joints
- Compact design and low profile

Style 661 monitor shown with Style 837-BC nozzle



Style 661

Style 661		
Max. GPM (LPM)		2000 (7570)
Inlet	Size	4" 6"
	Type	Flange
Outlet		3-1/2"
Control		Dual Hand-Wheel
Material		Brass
Finish		Red Powder Coating
Friction Loss		38 psi at 2000 gpm
		15 psi at 1200 gpm
Travel		135° Vertical
		360° Rotation
Weight		106 lbs. (48kg) to 119 lbs. (54kg)



PORTABLE GROUND MONITORS

Protek's Portable Ground Monitors are highly manoeuvrable, operating like handline nozzles while delivering much more water. These monitors are compact and lightweight with a low-profile design for stable operation. They are simple to set up for quick attack operations, and can be left unmanned at the fire scene to conserve manpower. The monitor body is constructed in hardcoat anodized aluminium with tough powder coating. Available in either single-inlet (Style 600-1) or dual-inlet (Style 600-2) models .

Features:

- Flow rate of up to 500 GPM (1900 LPM)
- Horizontal rotation is adjustable 20° each side of centre
- Elevation is adjustable from 30° to 60° unmanned , and down to 20° when manned
- Ball shutoff with locking handle
- Carbide-tipped spikes at the base is resistant to long-term wear and provide excellent ground stability
- Large handle for excellent portability

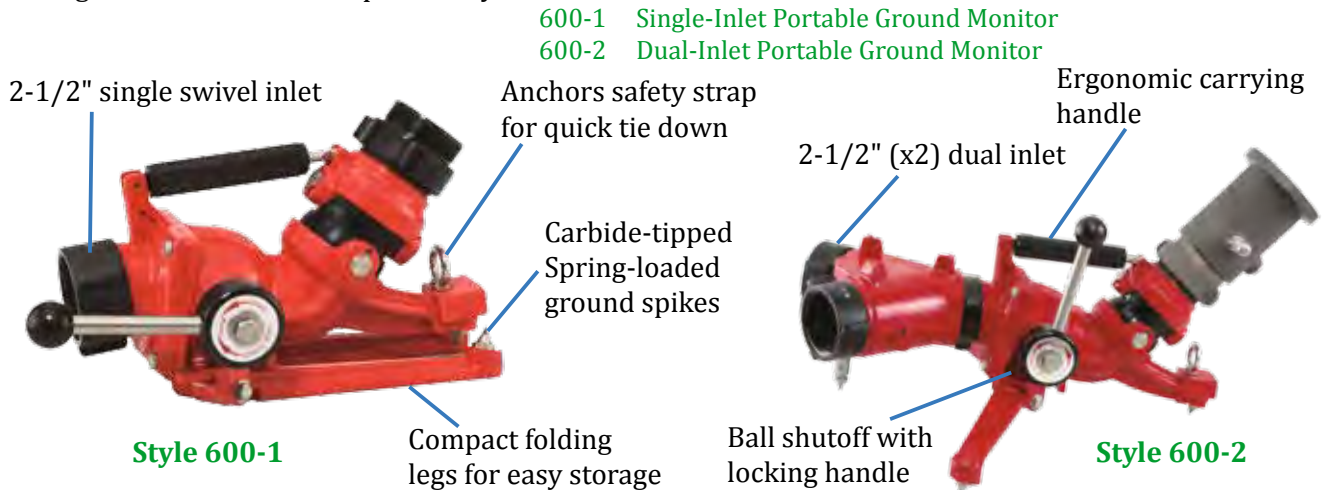

Compatible Protek nozzle and accessories



		Style 600-1	Style 600-2
Max. GPM (LPM)		500 (1900)	500 (1900)
Inlet	Size	2-1/2"	2-1/2" (x2)
	Type	Female Thread	Female Thread
Outlet		2-1/2"	2-1/2"
Control		Manual	Manual
Material		Alloy	Alloy
Finish		Red Powder Coating	Red Powder Coating
Friction Loss		10 psi at 500 gpm	10 psi at 500 gpm
		6 psi at 350 gpm	6 psi at 350 gpm
Travel	Vertical	30° - 60° (unmanned)	30° - 60° (unmanned)
		Down to 20° (manned)	Down to 20° (manned)
	Horizontal	20° Either Side	20° Either Side
Weight		14 lbs. (7 kg)	22 lbs. (10 kg)



DUAL-PURPOSE GROUND MONITORS

Protek's Dual-Purpose Ground Monitors are suitable for use as a portable monitor or a deck gun with features to meet the changing demands of the fire service. These monitors are compatible with a wide range of Protek nozzles. Available in either portable (Style 620 , 622-1 and 622-2) or deck-mount (Style 622-3) models.

Features:

- Full 3" waterway for flow rate of up to 1250 GPM (4800 LPM)
- Full 360° rotation in the deck model (Style 622-3) , 180° in the portable models (Style 620 , 622-1 and 622-2)
- Vertical travel of 63° from 12° to 75° above with inbuilt 37° safety stop from 18° to 55° above
- Carbide-tipped spikes for extended resistance to wear
- Large handle for excellent portability
- Fully enclosed worm gear is protected from the elements
- Dual integrated ball shut off enables shut off at both monitor inlet for enhanced control and flexibility
- Compatible with a wide range of Protek nozzles and accessories

622-1 Single-Inlet Dual-Purpose Portable Ground Monitors

622-2 Twin-Inlet Dual-Purpose Portable Ground Monitors

Style 622-1 and 622-2 monitor shown with Style 847 nozzle

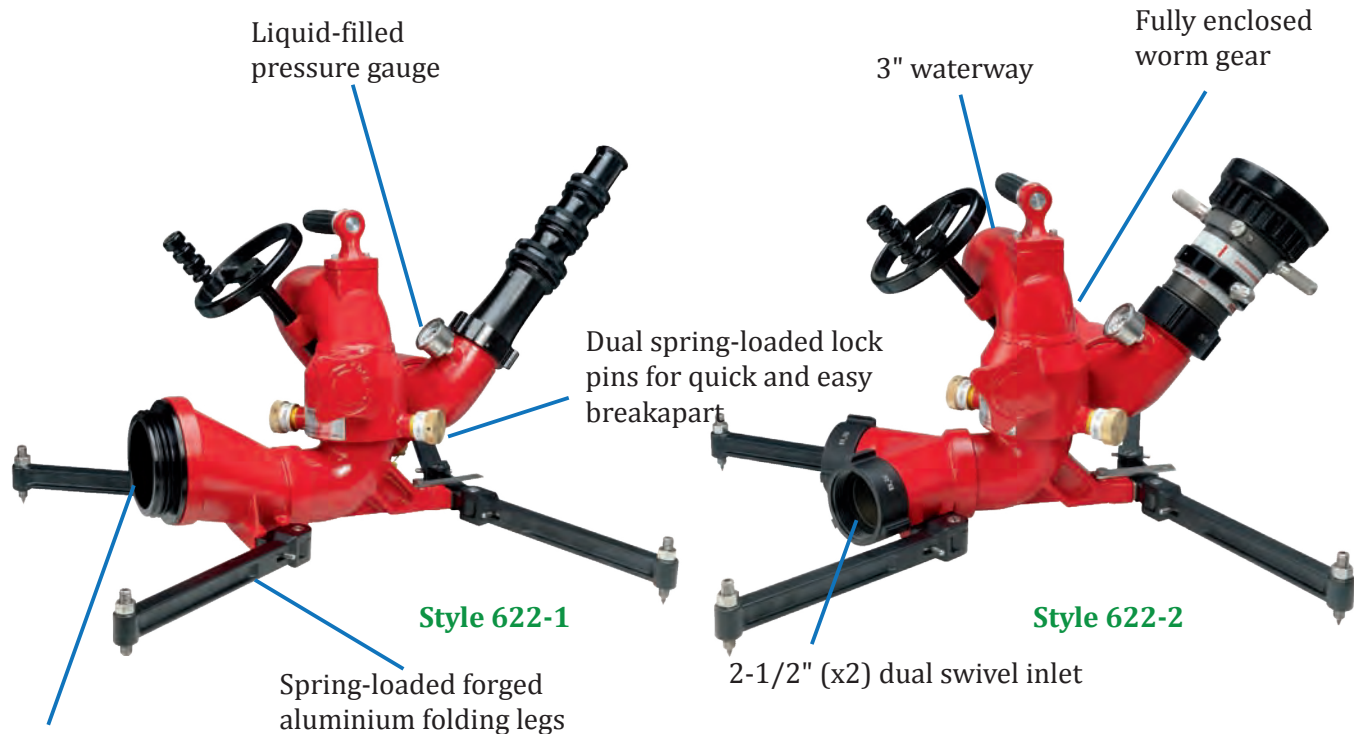

Single swivel inlet
(available in 2-1/2" to 5")



Carbide-tipped spike
for extended wear
resistance



DUAL-PURPOSE GROUND MONITORS

- 620 Dual-Purpose Portable Ground Monitors
- 622-3 Deck-Mount Dual-Purpose Portable Ground Monitors

Style 620 monitor shown with Style 120 quad staked

Style 622-3 Deck-Mount Ground Monitor Shown with Style 847 nozzle

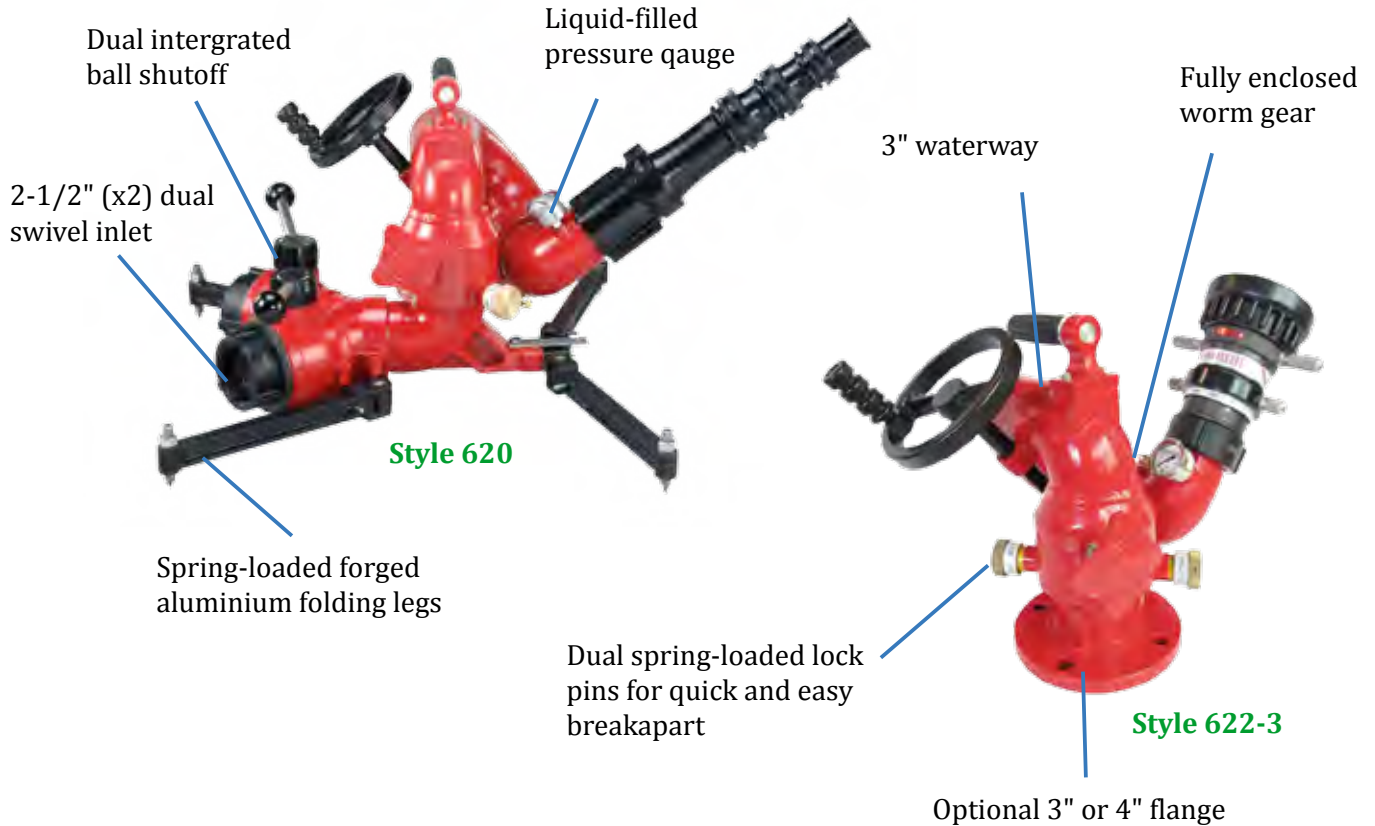

	Style 622-1	Style 622-2	Style 620	Style 622-3		
Max. GPM (LPM)	1000 (3800)*	800 (3030)		1250 (4800)		
Inlet	Size	2-1/2" to 5"	2-1/2" (x2)	3"	4"	3"
	Type	Thread	Thread	Flange		Thread
Outlet	2-1/2"	2-1/2"		2-1/2"		
Control	Single Hand-Wheel	Single Hand-Wheel		Single Hand-Wheel		
Material	Alloy	Alloy		Alloy		
Finish	Red Powder Coating	Red Powder Coating		Red Powder Coating		
Frition Loss	18 psi at 1000 gpm	15 psi at 800 gpm		24 psi at 1250 gpm		
	12 psi at 700 gpm	12 psi at 750 gpm		18 psi at 1000 gpm		
Travel	12° to 75° Vertical	12° to 75° Vertical		12° to 75° Vertical		
	180° Rotation	180° Rotation		360° Rotation		
Weight	32 lbs. (15 kg)	32 lbs. (15 kg)	37 lbs. (17 kg)	27 lbs. (12 kg)		

* Maximum flow rate is subject to selection of inlet size.



DUAL-PURPOSE GROUND MONITORS

Protek's Dual-Purpose Ground Monitors are compatible with a wide selection of Protek nozzles and accessories (see page 70)



Style 656 shown with
Style 622 monitor liftoff



Style 190
Direct Mount Flange



Style 120
Quad Stacked Tips



Style 119
Stream Shaper



Style 847
Monitor Nozzle



Style 887
Self-Educting Nozzle (500GPM)



Style 888
Self-Educting Nozzle (750GPM)



Style 656
Pipe



Style 622
Monitor Base



Style 622 Monitor Liftoff
Shown with Style 120
Quad Stacked Tips



PORTABLE OSCILLATING GROUND MONITORS

Protek's Portable Oscillating Ground Monitors have an effective sweeping water stream, designed for attack, cooling, protection and haz-mat situations. They are powered by a water-driven turbine that sweeps the outlet back and forth in a smooth and powerful motion while unmanned. As these monitors can be left unmanned, resources can be conserved for deployment in other areas. Available in either single-inlet (Style 625-1) or dual-inlet models (Style 625-2).

Features:

- The water-driven turbine induces the nozzle to oscillate at adjustable 12.5°, 15°, 20° or 25° either side of the centre
- The on/off knob can be activated to stop oscillation at any point
- The oscillating mechanism can be disengaged to enable manual horizontal rotation
- Elevation is adjustable between 20° and 60° unmanned
- Carbide tipped spikes at the base is resistant to long-term wear and provide excellent ground stability
- Large handle for excellent portability
- Inbuilt pressure gauge
- Powder coating provides additional resistance to corrosion and wear

625-1 Single-Inlet Portable Ground Monitor

625-2 Dual-Inlet Portable Ground Monitor

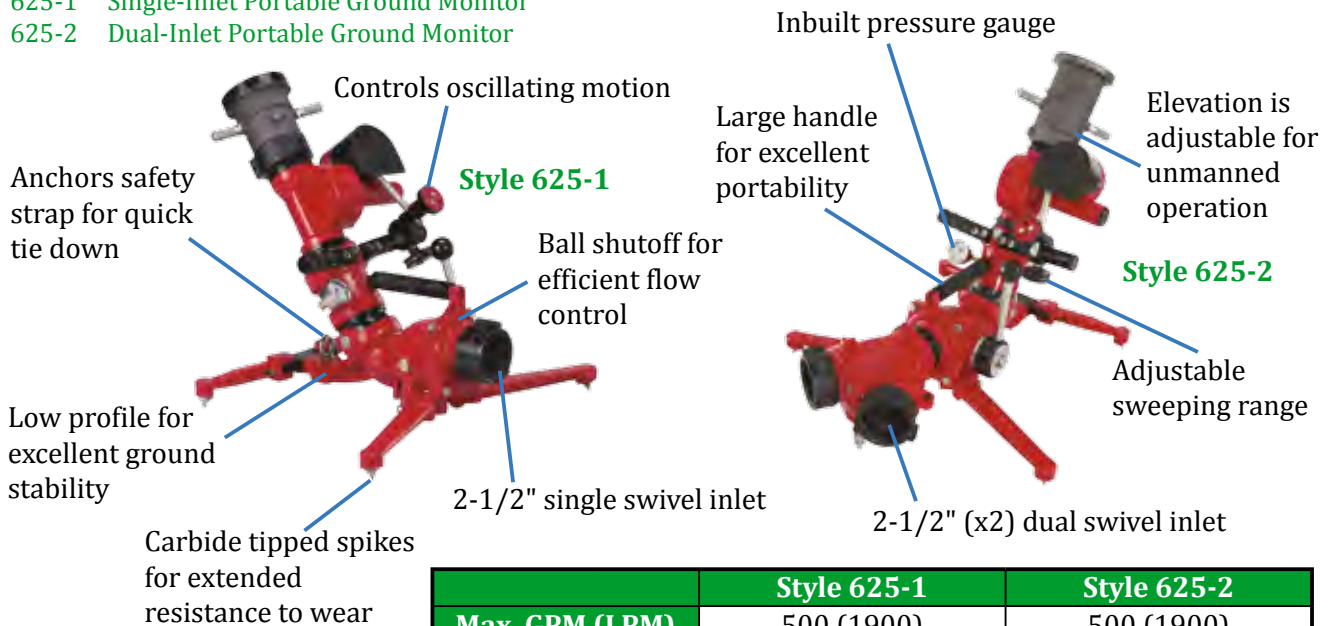

Style 625-1 monitor shown with Style 824 nozzle

Style 625-2 monitor shown with Style 822 nozzle

Oscillating speed (with straight bore tip)

Cycles Per Minute	Flow @ 100 PSI (7 BAR)
8	175 GPM (660 LPM)
11	225 GPM (850 LPM)
22	350 GPM (1325 LPM)
25	500 GPM (1900 LPM)

	Style 625-1	Style 625-2
Max. GPM (LPM)	500 (1900)	500 (1900)
Inlet	Size	2-1/2"
	Type	Female Thread
Outlet	2-1/2"	2-1/2"
Control	Manual	Manual
Material	Alloy	Alloy
Finish	Red Powder Coating	Red Powder Coating
Travel	40° Vertical	40° Vertical
Oscillating Degree		12.5°, 15°, 20°, 25°
		Either Side
Min. Oscillating Pressure	50 psi (3.5 bar)	50 psi (3.5 bar)
Weight	28 lbs. (13 kg)	35 lbs. (16 kg)



Oscillating Flange

- Protek's Oscillating Flange readily transforms a manual monitor into an oscillating monitor
- Very easy to set up by unbolting the existing monitor and inserting either the Style 911 or 916 conversion kit between the flanges
- All oscillating flange components are constructed of high-grade brass for superior resistance to corrosion and wear
- Oscillating movement is generated through a pelton wheel driven by water power
- Designed for refineries, process plants, tank farms, tank loading areas, offshore installation and other high-risk areas
- Totally water-powered (no electric connections)
- Heavy-duty low friction loss brass waterway
- Style 918 Oscillating Monitor is the combination of Style 911 Oscillating Flange and Style 611 Industrial Monitor

911, 916 Oscillating Flange



Style 911



Style 916

Style 918

Style 911 flange shown with Style 611 monitor and 848-BC nozzle



	Style 911	Style 916
Max. GPM (LPM)	1250 (4800)	1250 (4800)
Inlet Flange	3" or 4" ANSI	3" or 4" ANSI
Outlet Flange	3" or 4" ANSI	3" or 4" ANSI
Waterway	3"	3"
Operating Pressure	Min. 50 psi (3.5 bar) Max. 200 psi (14 bar)	Min. 50 psi (3.5 bar) Max. 200 psi (14 bar)
Oscillation Angle	Adjustable from 30° to 330°	Adjustable by 4 points 45°, 65°, 85°, 110°
Oscillation Speed*	6 cycles / min @100 psi	8 cycles / min @100 psi
Flow Rate through Water Drive Wheel	16 gpm @100 psi (7 bar)	12 gpm @100 psi (7 bar)
Test Connection	3/4" Garden hose	3/4" Garden hose
Speed Control	Brass Valve (Externally accessible)	Brass Valve (Externally accessible)
Weight	90 lbs (41 kg)	85 lbs (38 kg)

* Rated speed at 120° for Style 911 and at all oscillation angles for Style 916.



MONITOR ACCESSORIES

Monitor Accessories

140 Drain Boss

- 1/2" NPT or BSP
- Brass construction
- Compatible with Style 611, 612, 649, 660, 661 monitors and Style 911 oscillating flange



Style 140

560 Monitor Ball-Valve Shutoff

- High quality brass body
- Accomodates a wide range of Protek monitors
- Improved sealing and increased gating ability

	Style 560
Max. GPM (LPM)	1800 GPM (6800)
Inlet Flange	3", 4" ANSI or 3" NPT
Outlet Flange	3", 4" ANSI or 3" NPT
Waterway	3"
Operating Pressure	Min. 50 psi (3.5 bar) Max. 250 psi (17 bar)
Weight	54 lbs. (24.5 kg)



Style 560



Style 560 valve shown with Style 649 monitor

699 Hydrant Mount

- Allows a fixed site monitor to be mounted to a 2-1/2" (65 mm) hydrant port
- Height adjustment from the ground to centre of the hydrant discharge is 17-1/2" (445 mm) to 28" (712 mm)
- Length is 9-1/2" from the swivel to the middle of the flange
- 2-1/2" swivel inlet
- 3" or 4" ANSI outlet flange
- Maximum operating pressure 100 psi (7 bar)
- Maximum flow 1200 gpm (4500 lpm)

Style	Weight	Inlet	Outlet
699	40 lbs. (18.1 kg)	2-1/2" swivel	3" or 4" Flange



Style 699



REMOTE CONTROL MONITOR

Protek's Remote Control Monitor offers a rugged and durable design, suitable across various operations, including wildland fire fighting, deicing, fixed site facility, dust control and front bumper turret. This compact, lightweight, alloy-constructed monitor features a fully sealed integrated electrical control system with waterproof locking connectors, power and control connections to withstand harsh environments. The monitor is designed for water, foam and CAF applications. Compatible with Protek Electric Monitor Nozzles.

Features:

- 2-1/4" waterway for flow rate of up to 400 GPM (1525 LPM)
- Vertical travel of 135° from 90° above and 45° below horizontal
- Electric drives and circuit box are waterproof
- Gear motors totally enclosed and sealed to withstand harsh environments
- Current limit switch for pattern control, horizontal and vertical travel and open/close of electric valve
- Electronic controls with manual override
- Optional 180° or 300° horizontal rotation
- Automatic power off function during inactivity for enhanced performance and safety
- Programmable automatic oscillation and stow position
- Standard 24V with optional 12V or DC power supply

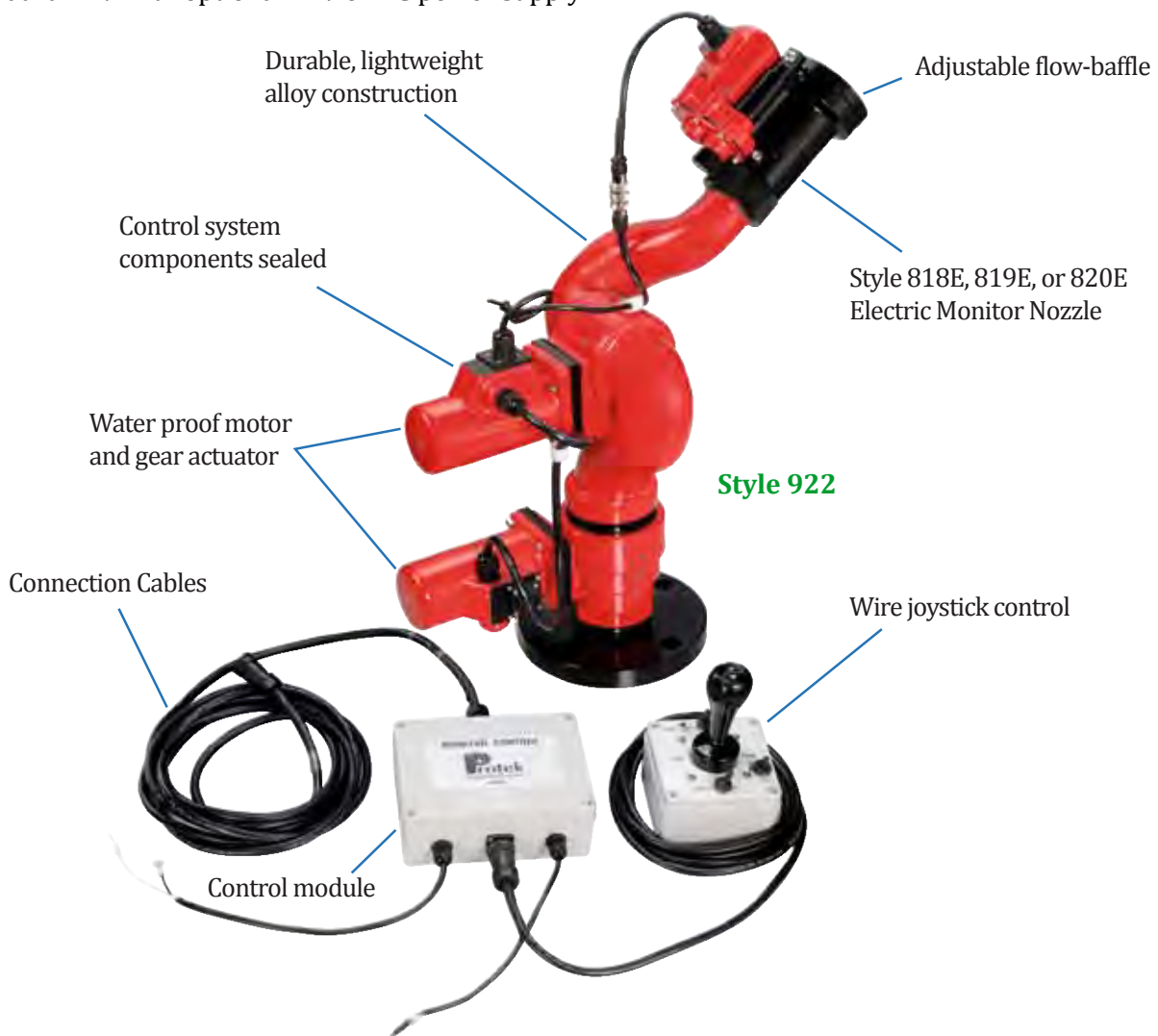

**Style 922 monitor shown with standard accessories:
Electric nozzle, control module, connection cables, cable joystick control**



REMOTE CONTROL MONITOR

Style 922				
Max. GPM (LPM)	400 (1525 LPM)		Finish	Red Powder Coating
Inlet	Size	2" (50mm) 2-1/2" (65mm)	Friction Loss	15 psi at 400 gpm
	Type	Female Thread Flange		12 psi at 350 gpm
Outlet	1-1/2" (38mm)		Travel	135° Vertical
Control	Electric			180° or 300° Rotation
Material	Alloy		Weight	15 lbs. (7 kg)

Protek's Remote Control Monitors are compatible with a wide selection of optional accessories which broadens the application of your monitors.



**Style 922
With Yellow Finish**



2" Electric Valve



Quick Connection



DC Power Supply



2.5" Flange



**Style 883
Self-ducting Monitor Nozzle**



**Style 111
Stream Shaper**



**Style 115
Smooth Bore Tips**



Terminal Board



WIRELESS REMOTE CONTROL MONITOR

Protek's Wireless Remote Control Monitors are technologically advanced electric deck monitors. Wireless remote control facilitates effective use of personnel and lowers the potential risk of injury from manual operations. There are no control cables between the joystick/transmitter and the monitor which significantly reduce installation costs. The monitors provide easy programming of oscillation for exposure protection or hazardous material suppression. Available in flows of up to 750 GPM (Style 933) or 1250 GPM (Style 935, 955). Compatible with Protek Electric Control Monitor Nozzles.

Features:

- Allows operator to control the stream from as far as 200 metres* away from the monitor for safety and efficiency
- 2-3/4" waterway for flow rate of up to 750 GPM for Style 933
- 3-1/4" waterway for flow rate of up to 1250 GPM for Style 935 and 955
- Cast-in turning vanes for efficient flow and minimal friction loss
- Optional 180° (Style 933, 935), 300° (Style 933, 935) and 360° (Style 955) horizontal rotation
- Vertical travel 90° above and 45° below horizontal
- Choice of adjustable flow-baffle or automatic electric nozzle (see page 53)
- Electronic controls with manual override
- Brushless electric motor designed to eliminate sparks and reduce risk of ignition
- Automatic power off function during inactivity for enhanced performance and safety
- Programmable automatic oscillation and stow position
- Standard 24V with optional integrated AC-110V or AC-220V
- Optional 12V or DC power supply



Style 933 monitor shown with standard accessories: Style 817E nozzle, control module, connection cables, primary transmitter and wireless transmitter



WIRELESS REMOTE CONTROL MONITOR

Style 935

Style 955



Style 935 monitor shown with standard accessories: Style 855E nozzle, control module, connection cables, panel mount primary transmitter and wireless handheld transmitter

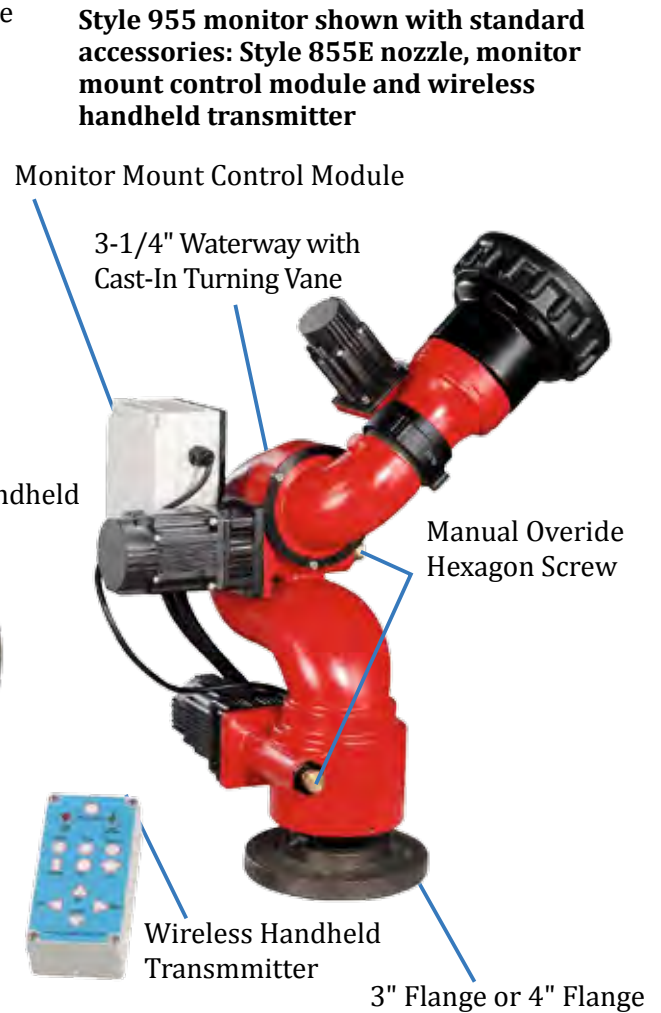

Style 955 monitor shown with standard accessories: Style 855E nozzle, monitor mount control module and wireless handheld transmitter

		Style 933			Style 935		Style 955	
Max. GPM (LPM)		750 (2900)			1250 (4800)		1250 (4800)	
Inlet	Size	3"	3"	4"	3"	4"	3"	4"
	Type	Thread	Flange		Flange		Flange	
Outlet		2-1/2"			2-1/2"		2-1/2"	
Control		Electric			Electric		Electric	
Material		Alloy			Alloy		Alloy	
Finish		Red Powder Coating			Red Powder Coating		Red Powder Coating	
Friction Loss		15 psi at 750 gpm			16 psi at 1250 gpm		16 psi at 1250 gpm	
		12 psi at 500 gpm			12 psi at 1000 gpm		12 psi at 1000 gpm	
Travel		135° Vertical			135° Vertical		135° Vertical	
		180° or 300° Rotation			180° or 300° Rotation		360° Rotation	
Weight		26 lbs. (12 kgs)			33 lbs. (15 kgs)		33 lbs. (15 kgs)	

* Remote control distance is subject to free transmission obstructions and battery discharge.



WIRELESS REMOTE CONTROL MONITOR

Protek's Remote Control Monitors are compatible with a wide selection of optional accessories which broadens the application of your monitors.



IRCS



Style 933
with Yellow Finish



Style 887
Self-educating Monitor Nozzle



Style 888
Self-educating Monitor Nozzle



Style 117, 118 and 120
Smooth Bore Tips



Style 119
Stream Shaper



Touch Screen
Control Panel



2.5" or 3"
Electric Valve



Wire or Wireless
Joystick Control



DC Power Supply



Terminal Board



3" or 4" Flange for
Style 933

INTEGRATED REMOTE CONTROL SYSTEM

Intergrated Remote Control System

Protek's Integrated Remote Control System (IRCS) is designed to protect important assets and properties from dangerous fires from a remote location. Suitable for diverse applications from industrial complexes, refineries, chemical plants, loading docks to railroad yards. The IRCS enables the operators to effectively control multiple monitors that are strategically positioned to protect the asset from a safe distance.

The IRCS comprises hardware (remote control monitors, electric nozzles and valves), electrical capabilities (master control touch panel and communication cables) and programming which are preset to your requirements. Protek customizes all aspects of the IRCS to deliver a system that is suited to your needs and integrated within your facilities.

Features:

- Effectively protects and monitors multiple designated locations or from a remote central station
- Effectively controls up to 16 monitors with an easy-to-use operating touch interface
- Offers alarm sensor with temperature deviation during activation
- Achieve more focused cost control and realize on-time delivery and installation
- Provides a tailored and scalable system to your specific requirements
- Provides build-in safety redundancy and reliability through back-up communications
- Delivers maximum performance and reliability whilst maintaining required project budget
- Provides flexible power supply options to accommodate the needs for most regions

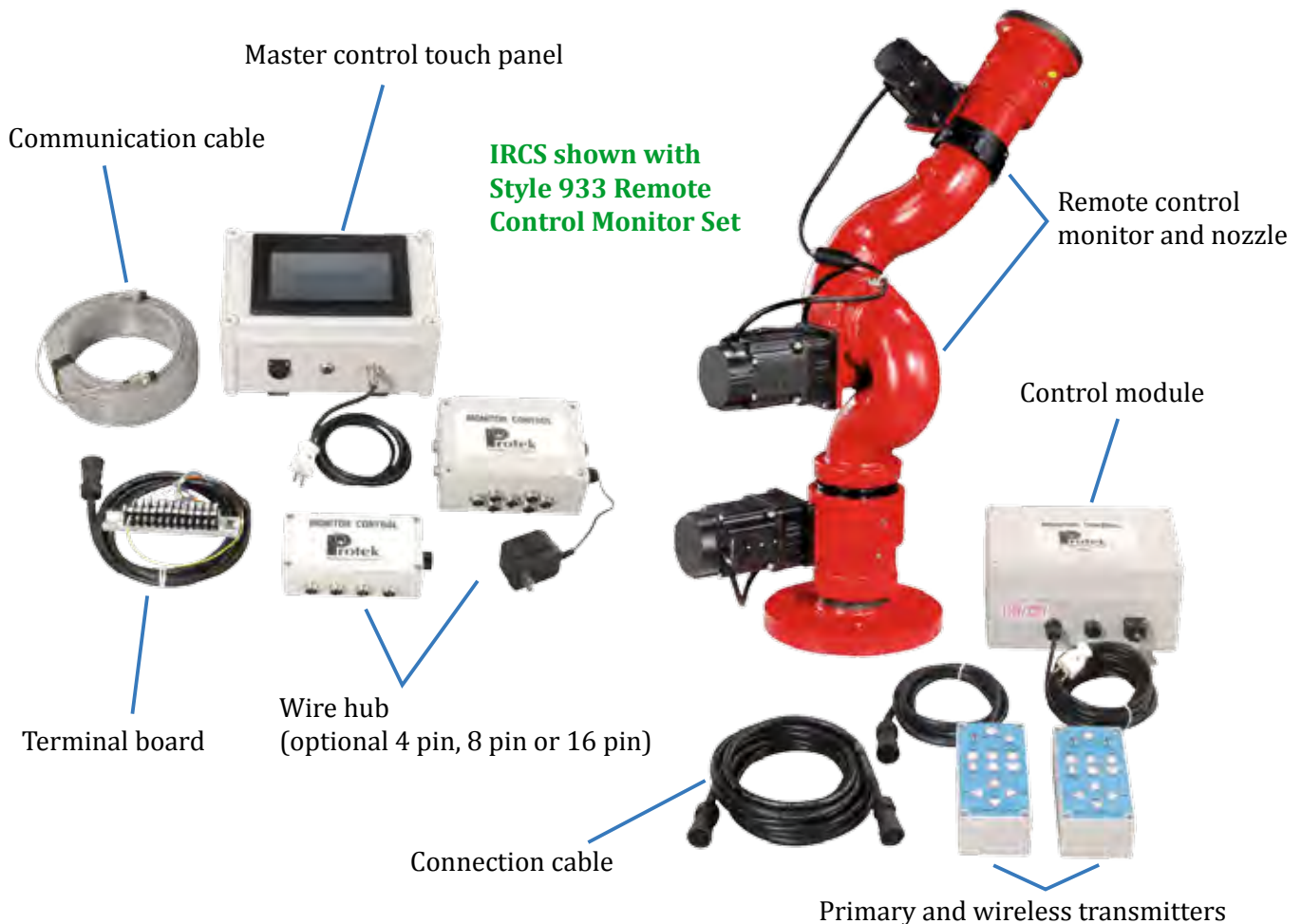

General Specifications

Available Flow (per monitor)	750-1250 GPM (2900-4800 LPM)
Number of Monitors in System	Up to 16 standard and as required
Material	Alloy
Control	Electric
Communication	Electric (discrete cable)
Power Supply	AC-110V or AC-220V

Note: The above noted options are only a sample of the available options.

Key Controls

The IRCS can be activated from a remote location with the master control touch panel that enables the operator to turn on the water supply, direct monitors vertically or horizontally, oscillate automatically, and change the stream pattern of the nozzle all from a safe distance. The monitors can also be remote controlled individually with wireless transmitters. Key standard control options include:

Screen 1



Master Control Touch Panel (Screen 1)

Home Page

Master Control Touch Panel (Screen 2)

- ① Network Connection On/Off Switch
- ② Power Connection On/Off Switch
- ③ Deployed Stations (station 4-8 or 16)

Screen 2



Master Control Touch Panel (Screen 3)

- ① Stop stop or oscillating mode
- ② Return to stow position
- ③ Enable oscillation
- ④ Inlet ball valve On/Off switch
- ⑤ Straight Stream
- ⑥ Upward vertical travel
- ⑦ Fog pattern
- ⑧ Right horizontal travel
- ⑨ Downward vertical travel
- ⑩ Left horizontal travel
- ⑪ Stream pattern panel
- ⑫ Vertical travel panel
- ⑬ Horizontal travel panel

Screen 3

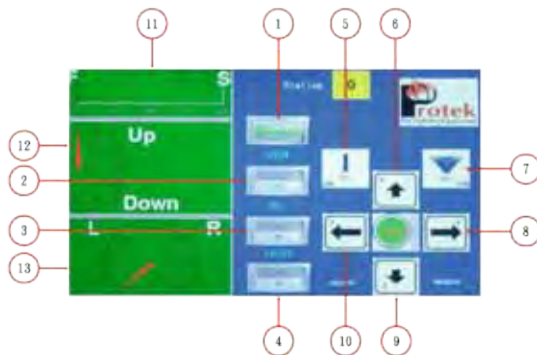

INTEGRATED REMOTE CONTROL SYSTEM

Application

Below is an example of custom-designed system/site lay-out. Each System lay-out carefully assesses application function, site constraints and risk for optimal design.

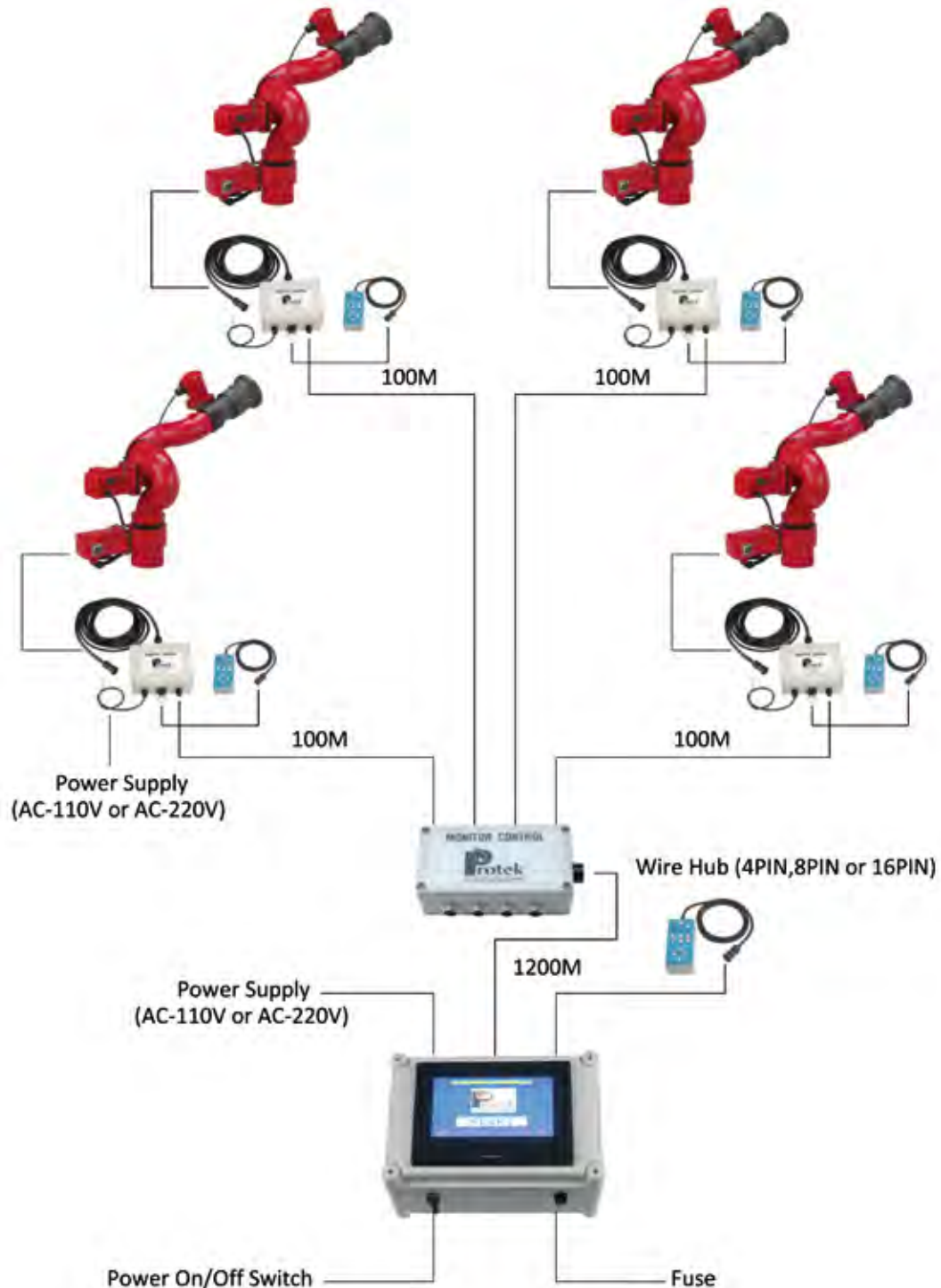

Protek's Foam Educators range offers the In-Line Educators and the Portable By-Pass Educators. The educators feature a removable metering valve, and a large and easy-to-read removable metering dial with adjustable settings of between 0% to 6%. Compatible with most foam concentrates.

Features:

- Educators are rated for optimum flow at 200 psi (14 bar) inlet pressure
- Works well with nozzles rated at 75 psi (5 bar) and 100 psi (7 bar)
- Ball check valve prevents back flow into foam concentrate
- Supplied with clear foam pick up tube



In-Line Educators

- 1-1/2" or 2-1/2" swivel inlet x 1-1/2" male
- 6-1/2' pickup hose and 15" stainless steel tube
- Pickup rate may be set at any position between 0% to 6% with detentes at 1/4, 1/2, 1, 3, and 6%

- 201-60 In-Line Educator**
- Brass construction
 - 60 GPM (230 LPM)

Style 201

- 201-95 In-Line Educator**
- Brass construction
 - 95 GPM (360 LPM)

- 203-60 In-Line Educator**
- Lightweight alloy
 - 60 GPM (230 LPM)

- 203-95 In-Line Educator**
- Lightweight alloy
 - 95 GPM (360 LPM)

Style 203

- 203-125 In-Line Educator**
- Lightweight alloy
 - 125 GPM (475 LPM)



Style	Material	Inlet	Outlet	Flow		Length	Weight Lbs. (kg)
				GPM	LPM		
201-60	Brass	1-1/2" or 2-1/2"(38 or 65mm)	1-1/2"(38mm)	60	230	10.5"(276mm)	9.2(4.2kg)
201-95	Brass	1-1/2" or 2-1/2"(38 or 65mm)	1-1/2"(38mm)	95	360	10.5"(267mm)	9.2(4.2kg)
203-60	Alloy	1-1/2" or 2-1/2"(38 or 65mm)	1-1/2"(38mm)	60	230	8.6"(218mm)	3.5(1.6kg)
203-95	Alloy	1-1/2" or 2-1/2"(38 or 65mm)	1-1/2"(38mm)	95	360	8.6"(218mm)	3.5(1.6kg)
203-125	Alloy	1-1/2" or 2-1/2"(38 or 65mm)	1-1/2"(38mm)	125	475	8.6"(218mm)	3.5(1.6kg)



FOAM EDUCTORS

In-Line Eductor

205-250 In-Line Eductor

- Lightweight alloy
- 2-1/2" swivel x 2-1/2" male
- 250 GPM (950 LPM)
- 9' pickup hose and 15" stainless steel tube
- Pickup rate may be set at any position between 0% to 6% with detentes at 1/4, 1/2, 1, 3, and 6%



Style 205

Style	Material	Inlet	Outlet	Flow		Length	Weight Lbs(kg)
				GPM	LPM		
205-250	Alloy	2-1/2" (65mm)	2-1/2" (65mm)	250	950	12" (305mm)	8 (3.6kg)

Portable By-Pass Eductors

- Brass Construction
- 1-1/2" or 2-1/2" swivel inlet x 1-1/2" male
- Allows the operator to easily change from water to foam without shutting down
- Easy to change into water line use
- 6-1/2' pickup hose and 15" stainless steel tube
- Pickup rate may be set at any position between 0% to 6% with detentes at 1/4, 1/2, 1, 3, and 6%

222-60 Portable By-Pass Eductor

- 60 GPM (230 LPM)

222-95 Portable By-Pass Eductor

- 95 GPM (360 LPM)

222-125 Portable By-Pass Eductor

- 125 GPM (475 LPM)



Style 222

Style	Material	Inlet	Outlet	Flow		Length	Weight Lbs(kg)
				GPM	LPM		
222-60	Brass	1-1/2" or 2-1/2" (38 or 65mm)	1-1/2" (38mm)	60	230	17" (432mm)	22 (10kg)
222-95	Brass	1-1/2" or 2-1/2" (38 or 65mm)	1-1/2" (38mm)	95	360	17" (432mm)	22 (10kg)
222-125	Brass	1-1/2" or 2-1/2" (38 or 65mm)	1-1/2" (38mm)	125	475	17" (432mm)	22 (10kg)



GATED WYES, WATER THIEF & SIAMESE

Protek offers a wide selection of valves, including wyes, water thief and siamese. Wyes are used to divide a single flow, allowing fire fighters to extend attack lines when pre-connects do not reach. Both 2-way and 3-way wye options are available. Water Thief allows fire fighters to extend attack lines from a main supply line. Siamese is used to combine several hose lines into one. Both dual-inlet and trio-inlet siamese options are available.

Wyes

- Available in lightweight alloy or brass construction
- Working pressure up to 200 psi (14 bar)
- Easy operation even at high flows
- Minimal friction loss
- Used to divide a single flow

505

Forestry Wye

- Male adapters are easily removed for seat adjustment
- 1" female inlet x two 1" male outlets



Style 505



Style 506

506

Forestry Wye

- 1-1/2" female inlet x two 1" or 1-1/2" male outlets



Style 520

520, 520-BC

Leader Line Wye

- 2-1/2" female inlet x two 1-1/2" male outlets

530

Leader Line Wye

- Self-locking handle for positive handle positioning
- 2-1/2" female inlet x two 1-1/2" male outlets



Style 520-BC

540, 540-BC

Hydrant Wye

- 2-1/2" to 6" female inlet x two 2-1/2" male outlets
- Self-locking handle for positive handle positioning



Style 530



Style 540

Style	Material	Inlet	Outlet	Weight Lbs(kg)
505	Alloy	1" F (25mm)	1"M (x2) (25mm)	2.2 (1kg)
506	Alloy	1-1/2" F (38mm)	1" or 1-1/2"M (x2) (25 or 38mm)	2.2 (1kg)
520	Alloy	2-1/2" F (65mm)	1-1/2"M (x2) (38mm)	4 (1.8kg)
520-BC	Brass	2-1/2" F (65mm)	1-1/2"M (x2) (38mm)	9 (4.1kg)
530	Alloy	2-1/2" F (65mm)	1-1/2"M (x2) (38mm)	6.4 (2.9kg)
540	Alloy	2-1/2" to 6" F (65-150mm)	2-1/2"M (x2) (65mm)	14.3 (6.4kg)
540-BC	Brass	2-1/2" to 6" F (65-150mm)	2-1/2"M (x2) (65mm)	33 (15kg)



Style 540-BC



GATED WYES, WATER THIEF & SIAMESE

541

Hydrant Wye

- 2-1/2" female inlet x two 2-1/2" male outlets



Style 541

542

Multi-Purpose Wye

- Flexibility of combining two hose lines in to one or dividing single flow into two way discharge
- Two 2-1/2" male or female inlets x 3" male or female outlet
- Optional outlet size from 2-1/2" to 6" male or female thread



Style 542

550

3-Way Hydrant Wye

- Self-locking handle for positive handle positioning
- 2-1/2" to 6" female inlet x three 2-1/2" male outlets



Style 550

587

Plain Wye

- 2-1/2" female inlet x two 2-1/2" male outlets

Style	Material	Inlet	Outlet	Weight Lbs(kg)
541	Alloy	2-1/2" F (65mm)	2-1/2"M (x2) (65mm)	8.8 (4kg)
542	Alloy	2-1/2" M or F (x2)(65mm)	3" M or F (75mm)	12 (5.5 kg)
550	Alloy	2-1/2" to 6" F (65-150mm)	2-1/2"M (x3) (65mm)	20 (9.2kg)
587	Alloy	2-1/2" F (65mm)	2-1/2"M (x2) (65mm)	3.7 (1.7kg)



Style 587

Water Thief

- Lightweight alloy
- Self-locking handle for positive handle positioning
- Used for laying, extending or adding 1-1/2" or 2-1/2" lines without interfering with operation of other lines
- 2-1/2" female inlet x one 2-1/2" and two 1-1/2" male outlets

510

Water Thief

Style	Material	Inlet	Outlet	Weight Lbs. (kg)
510	Alloy	2-1/2"F (65mm)	1-1/2"M (x2) & 2-1/2"M (x1) (38 & 65mm)	13.5 (6.1kg)



Style 510



Siamese

- Available in lightweight alloy or brass construction
- Used to combine several hose lines into one
- Clappers allow additional lines to be added without interrupting flow

545, 545-BC Suction Siamese

- Used as suction inlet collection for pumpers
- Self-locking handle for positive handle positioning
- 2-1/2" swivel inlets come with strainers
- Two 2-1/2" female inlets x 2-1/2" to 6" female



Style 545

555 3-Way Suction Siamese

- Used as suction inlet collection for pumpers
- Self-locking handle for positive handle positioning
- 2-1/2" swivel inlets come with strainers
- Three 2-1/2" female inlets x 2-1/2" to 6" female outlet

585 Clappered Valve Siamese

- Clappers allow additional lines to be added without interrupting flow
- Two 2-1/2" female inlet x 2-1/2" male outlet
- Come with drain valve



Style 555

Style	Material	Inlet	Outlet	Weight Lbs. (kg)
545	Alloy	2-1/2"F (x2) (65mm)	2-1/2" to 6"F (65-150mm)	15.8 (7.2kg)
545-BC	Brass	2-1/2"F (x2) (65mm)	2-1/2" to 6"F (65-150mm)	36 (16.5kg)
555	Alloy	2-1/2"F (x3) (65mm)	2-1/2" to 6"F (65-150mm)	21.3 (9.7kg)
585	Alloy	2-1/2"F (x2) (65mm)	2-1/2"M (65mm)	7 (3.2kg)



Style 585

Valves

595 2-1/2" Hydrant Valve

- Lightweight alloy
- 2-1/2" full flow waterway
- Self-locking handle for positive handle positioning
- Adapter easily removed for seat adjustment
- 2-1/2" female inlet x 2-1/2" male outlet



Style 595

596 2-1/2" Gate Valve

- Lightweight alloy
- Wedge seat gate valve
- Non-rising stem design
- Crank handle for easier operation
- 2-1/2" female inlet x 2-1/2" male outlet



Style 596

Style	Material	Inlet	Outlet	Weight Lbs. (kg)
595	Alloy	2-1/2"F (65mm)	2-1/2"M (65mm)	7.3 (3.3kg)
596	Alloy	2-1/2"F (65mm)	2-1/2"M (65mm)	4.6 (2.1kg)



SERVICE KITS

Handline Nozzles	
Style	Service Kit
236	1236
238	1238
277	1277
279	1001
280	1010
302	1302
303	1302
310	1007
311	1007
312	1008
314	1009
314-TP	1009-TP
321	1010
322	1010
323	1011
324	1012
324-TP	1012-TP
332	1032
333	1033
360	1000
361	1000
361F	1000
362	1000
366	1001
366-BC	1001-BC
366E	1001
366E-BC	1001-BC
366-F	1366-F
367	1002
367-BC	1002-BC
368	1002
368-TP	1002-TP
368-BC	1002-BC
369	1002
371	1000
372	1001
372-BC	1001-BC
372E	1001
372E-BC	1001-BC
372-F	1372F
373	1002
373-BC	1002-BC
374	1002
374-BC	1002-BC
375	1003
379	1001
396	1396

Monitors	
Style	Service Kit
600	1600
605	1605
611	1611
612	1611
622	1622
636	1636
649	1649
736	1736

Monitor Nozzles	
Style	Service Kit
818	1818
818-BC	1818-BC
819	1818
819-BC	1818-BC
820	1818
820-BC	1818-BC
822	1822
822-BC	1822-BC
823	1822
823-BC	1822-BC
824	1826
824-BC	1826-BC
825-BC	1825-BC
830	1830
835	1835
835-BC	1835-BC
837-BC	1837-BC
845	1845
845-BC	1845-BC
846	1846
847	1846-BC
847-BC	1846-BC
848	1848
848-BC	1848-BC
849	1848
849-BC	1848-BC
881-BC	1881-BC
883-BC	1881-BC
886	1886
886-BC	1886-BC
887	1886
887-BC	1886-BC
888	1888
888-BC	1888-BC
889	1889
889-BC	1889-BC

Protek has tailored service kits for all of our product lines.

Each kit contains the most frequently replaced parts.

Complete parts listing and drawing are provided with each service kit.



If you require service kits or have other technical queries, please contact us on:

technical@protektfire.com.tw

Foam Eductors	
Style	Service Kit
201-60	1201
201-95	1201
203-60	1203
203-95	1203
203-125	1203
205-250	1205
222-60	1222
222-95	1222
222-125	1222

Valves	
Style	Service Kit
505	1505
506	1505
510	1510
520	1520
520-BC	1520-BC
530	1530
540	1540
540-BC	1540-BC
541	1541
545	1540
545-BC	1540-BC
550	1550
555	1550
585	1585
587	1587
595	1595
596	1596



The flow and reach data provides you with key information on our handline nozzle capabilities. The following table outlines the flow setting and the straight stream reach for our handline nozzles at various pressures. The data is compiled and updated by our Engineering & Testing departments.

Selectable Gallonage Handline Nozzles

Style	Nozzle Pressure		Flow Setting		Actual Flow		Straight Stream Reach			
	PSI	BAR	GPM	LPM	GPM	LPM	Effective		Overall	
							Feet	Meters	Feet	Meters
360 (page 3)	75	5	5	19	4	15	45	13	55	16
			10	37	9	34	45	13	55	16
			24	90	21	79	65	19	75	22
			40	150	35	132	75	22	85	26
	100	7	5	19	5	19	50	15	60	18
			10	37	10	37	50	15	60	18
			24	90	24	90	70	21	80	24
			40	150	40	150	90	27	100	30
	125	8.5	5	19	6	22	55	16	65	20
			10	37	11	42	55	16	65	20
			24	90	27	102	70	21	80	18
			40	150	45	170	90	29	105	32
361 (page 3)	75	5	13	50	11	42	50	15	60	18
			25	100	22	83	60	18	70	21
			40	150	35	132	75	22	85	25
			60	230	52	197	95	29	105	32
	100	7	13	50	13	50	55	16	65	20
			25	100	25	100	60	18	70	21
			40	150	40	150	90	27	100	30
			60	230	60	230	105	32	115	35
	125	8.5	13	50	15	57	55	16	65	19
			25	100	28	106	65	19	75	23
			40	150	45	170	95	29	105	32
			60	230	67	254	110	34	120	36
362 (page 3)	75	5	12	50	10	38	50	15	60	18
			23	90	20	76	65	19	75	22
			30	115	26	98	70	21	80	24
	100	7	12	50	12	50	55	16	65	19
			23	90	23	90	70	21	80	24
			30	115	30	115	75	22	85	26
	125	8.5	12	50	13	49	60	18	70	21
			23	90	26	98	70	21	80	24
			30	115	34	129	80	24	90	27

Notes

Reach figures are measured with nozzle at 32° above horizontal. Overall reach is considered where the furthest droplets of water fall, in still conditions. Effective reach is considered the furthest portion of the water droplet foot print where fire fighting can be accomplished, in still conditions. These tests are conducted in still conditions, so the actual results will vary depending upon conditions.



FLOW & REACH DATA

The flow and reach data provides you with key information on our handline nozzle capabilities. The following table outlines the flow setting and the straight stream reach for our handline nozzles at various pressures. The data is compiled and updated by our Engineering & Testing departments.

Selectable Gallonage Handline Nozzles

Style	Nozzle Pressure		Flow Setting		Actual Flow		Straight Stream Reach			
	PSI	BAR	GPM	LPM	GPM	LPM	Effective		Overall	
							Feet	Meters	Feet	Meters
366 (page 4)	75	5	30	115	26	98	80	24	90	27
			60	230	52	197	100	30	110	34
			95	360	82	310	120	36	130	39
			125	475	108	409	130	40	140	42
	100	7	30	115	30	115	85	26	95	29
			60	230	60	230	105	30	115	35
			95	360	95	360	125	38	135	41
			125	475	125	475	140	42	150	45
	125	8.5	30	115	34	129	90	27	100	30
			60	230	67	254	110	34	120	36
			95	360	107	401	125	38	130	41
			125	475	140	530	135	41	145	44
367, 368 (page 5-6)	75	5	95	360	82	310	115	35	125	38
			125	475	108	409	125	38	135	41
			150	550	130	492	145	44	155	47
			200	750	173	654	155	47	165	50
			250	950	217	821	160	48	170	51
	100	7	95	360	95	360	140	42	150	45
			125	475	125	475	150	45	160	68
			150	550	150	550	160	48	170	51
			200	750	200	750	170	51	180	54
			250	950	250	950	175	53	185	56
	125	8.5	95	360	106	401	115	44	155	47
			125	475	140	530	145	47	165	50
			150	550	168	636	160	48	170	51
			200	750	224	848	175	53	185	56
			250	950	280	1060	185	56	195	59

Notes

Reach figures are measured with nozzle at 32° above horizontal. Overall reach is considered where the furthest droplets of water fall, in still conditions. Effective reach is considered the furthest portion of the water droplet foot print where fire fighting can be accomplished, in still conditions. These tests are conducted in still conditions, so the actual results will vary depending upon conditions.



The flow and reach data provides you with key information on our handline nozzle capabilities. The following table outlines the flow setting and the straight stream reach for our handline nozzles at various pressures. The data is compiled and updated by our Engineering & Testing departments.

Multi-Purpose Handline Nozzles

Orifice Size	Nozzle Pressure		Smooth Bore Flow		Straight Stream Reach			
	PSI	BAR	GPM	LPM	Effective		Overall	
					Feet	Meters	Feet	Meters
3/8"	50	3.5	23	87	55	17	65	20
	75	5	50	114	65	20	75	23
1/2"	50	3.5	45	170	65	20	75	23
	75	5	60	227	85	26	95	29
5/8"	50	3.5	75	284	85	26	95	29
	75	5	95	360	105	32	115	35
3/4"	50	3.5	108	409	105	32	115	35
	75	5	135	571	115	35	125	38
7/8"	50	3.5	155	587	135	41	145	44
	75	5	190	719	155	47	165	50
15/16"	50	3.5	187	708	135	41	145	44
	75	5	229	867	155	47	165	50
1"	50	3.5	216	818	140	43	150	46
	75	5	266	1007	160	48	170	52

Combination Flows

Style	Tip Size	Inlet Pressure		Flow	
		PSI	BAR	GPM	LPM
332 (page 9)	3/8"	50	3.5	66	250
		75	5	78	295
	1/2"	50	3.5	88	333
		75	5	107	405
	5/8"	50	3.5	108	409
		75	5	136	515
333 (page 9)	3/4"	50	3.5	199	753
		75	5	247	935
	7/8"	50	3.5	232	878
		75	5	289	1094
	15/16"	50	3.5	250	946
		75	5	313	1185
	1"	50	3.5	270	1022
		75	5	334	1264

Fog Flows

Style	Inlet Pressure		Flow	
	PSI	BAR	GPM	LPM
332	50	3.5	42	160
	70	5	52	197
	100	7	60	226
333	50	3.5	95	360
	75	5	118	445
	100	7	135	510

Notes

Reach figures are measured with nozzle at 32° above horizontal. Overall reach is considered where the furthest droplets of water fall, in still conditions. Effective reach is considered the furthest portion of the water droplet foot print where fire fighting can be accomplished, in still conditions. These tests are conducted in still conditions, so the actual results will vary depending upon conditions.



FLOW & REACH DATA

The flow and reach data provides you with key information on our handline nozzle capabilities. The following table outlines the flow setting and the straight stream reach for our handline nozzles at different pressures. The data is compiled and updated by our Engineering & Testing departments.

Constant Gallonage Handline Nozzles

Style	100 psi Flow Setting	Actual Flow				Straight Stream Reach						
						Effective			Overall			
		75 psi 5 bar	100 psi 7 bar	125 psi 8.5 bar		75 psi 5 bar	100 psi 7 bar	125 psi 8.5 bar	75 psi 5 bar	100 psi 7 bar	125 psi 8.5 bar	
371 (page 15)	13	11	13	15	GPM	55	65	75	65	75	85	Feet
	50	42	49	57	LPM	16	20	23	20	23	26	Meters
	25	22	25	28	GPM	70	75	85	80	85	95	Feet
	100	83	100	106	LPM	21	23	26	24	26	29	Meters
	40	35	40	45	GPM	75	85	95	85	95	105	Feet
	150	132	150	170	LPM	23	26	29	26	29	32	Meters
	60	52	60	67	GPM	85	95	105	95	105	115	Feet
372 (page 15)	230	197	230	254	LPM	26	29	32	29	32	35	Meters
	60	52	60	67	GPM	85	95	105	95	105	115	Feet
	95	82	95	106	GPM	90	115	125	100	125	135	Feet
	360	310	360	401	LPM	27	35	38	30	38	41	Meters
	125	108	125	140	GPM	115	125	135	125	135	145	Feet
	475	409	475	530	LPM	35	38	41	38	41	44	Meters
373 (page 16)	150	130	150	168	GPM	135	145	160	140	155	165	Feet
	550	492	550	636	LPM	41	44	47	44	47	50	Meters
	200	173	200	224	GPM	130	145	160	140	155	170	Feet
	750	655	750	848	LPM	40	44	49	42	47	52	Meters
	250	217	250	280	GPM	150	160	170	160	170	180	Feet
	950	821	950	1060	LPM	45	49	52	49	52	55	Meters
374 (page 16)	200	173	200	224	GPM	140	160	170	150	170	180	Feet
	750	655	750	848	LPM	42	49	52	45	52	55	Meters
	250	217	250	280	GPM	160	170	185	170	180	195	Feet
	950	821	950	1060	LPM	49	52	56	52	55	59	Meters
	300	260	300	335	GPM	170	190	200	180	200	210	Feet
	1140	984	1140	1268	LPM	52	58	61	55	61	64	Meters

Notes

Reach figures are measured with nozzle at 32° above horizontal. Overall reach is considered where the furthest droplets of water fall, in still conditions. Effective reach is considered the furthest portion of the water droplet foot print where fire fighting can be accomplished, in still conditions. These tests are conducted in still conditions, so the actual results will vary depending upon conditions.



COMPATIBILITY CHART

These charts are designed to help you determine the compatibility of Protek monitors with its wide selection of nozzles and available accessories. It will assist you in choosing the suitable nozzle(s) for your new monitor as well as the accessories that you may like to add in order to broaden the application of your monitor.



Combination of Style 911 oscillating flange, Style 611 monitor and Style 847-BC monitor nozzle

Combination of Style 649 monitor and Style 848-BC monitor nozzle

Monitors	Accessories					
Industrial Monitors						
605	111-BC					
611	119-BC	140	560	699	911	916
612	119-BC	140	560	699	911	916
633	119	560	699	911	916	
636	119-BC	560	699	911	916	
648	119-BC	560	699	911	916	
649	119-BC	140	560	699	911	916
655	119	560	699	911	916	
660	109	140				
661	109	140				
736	119-BC	560	699	911	916	
Portable Ground Monitors						
600-1	119	196				
600-2	119					
Portable Dual Purpose Ground Monitors						
620	119	190				
622-1	119	190				
622-2	119	190				
622-3	119	656	699			
Remote Controlled Monitors						
922	Electric Valve, Quick Connection, Stream Shaper					
Wireless Remote Controlled Monitors						
933	Touch Screen Control Panel, Wire or Wireless					
935,955	Joystick Control, Electric Valve, IRCS, Stream Shaper					

Monitors	Nozzles (Handline / Monitors / Self-Educting) & Smooth Bore Tips												
Industrial Monitors													
605	366-BCTO	367-BCTO	372-BCTO	373-BCTO	818-BC	819-BC	820-BC	881-BC	883-BC				
611	823-BC	825-BC	830	832	835-BC	845-BC	847-BC	848-BC	887-BC	888-BC	889-BC		
612	823-BC	825-BC	830	832	835-BC	845-BC	847-BC	848-BC	887-BC	888-BC	889-BC		
633	823	825	830	832	835	845	847	848	887	888	889		
636	823-BC	847-BC	887-BC	888-BC									
648	823-BC	825-BC	830	832	835-BC	845-BC	847-BC	848-BC	887-BC	888-BC	889-BC		
649	823-BC	825-BC	830	832	835-BC	845-BC	847-BC	848-BC	887-BC	888-BC	889-BC		
655	823	825	830	832	835	845	847	848	887	888	889		
660	121	833	837-BC										
661	121	833	837-BC										
736	823-BC	825-BC	830	832	835-BC	845-BC	847-BC	848-BC	887-BC	888-BC	889-BC		
Portable Ground Monitors													
600-1	117	118	314-TO	368-TO	375-TO	822	824	881	883	886	887		
600-2	117	118	314-TO	368-TO	375-TO	822	824	881	883	886	887		
Portable Dual Purpose Ground Monitors													
620	120	822	823	835	847	887	888						
622-1	120	822	823	825	830	832	835	845	847	887	888		
622-2	120	822	823	835	847	887	888						
622-3	120	822	823	825	830	832	835	845	847	848	887	888	889
Portable Oscillating Ground Monitors													
625-1	118	822	824	883	886	887							
625-2	118	822	824	883	886	887							
Remote Controlled Monitors													
922	818E	819E	820E	881	883								
Wireless Remote Controlled Monitors													
933	817E	887	888										
935,955	855E	887	888	889									



EDUCTOR/NOZZLE PERFORMANCE DATA

This chart is designed to help you better understand the performance of our foam eductors at various operating pressures. It will also help you choose a nozzle that is compatible with your eductor.

All of our eductors achieve their rated flow at an inlet pressure of 200 psi. At lower pressures the water flow is less, but the flow of foam concentrate will remain the same. Consequently, the foam solution will be a richer mixture than the metering valve indicates. In addition, at lower pressures (flows) the effective reach of the nozzles decreases. Please take this into account when making your initial attack.

Foam Eductors

Eductor (pages 61-62)	Recommended Nozzles For Use With Eductor	Inlet Pressure	Flow Rate*		Maximum Hose Lay [^] (feet)	Nozzle Pressure (psi)	Effective Reach# (feet)
			GPM	LPM			
201-60 203-60 222-60	366, 372, 366-BC, 372-BC, 366E, 372E, 366E-BC, 372E-BC	200	60	231	100	100	85
		120	52	197	100	75	75
		100	42	156	100	50	65
201-95 203-95 222-95	366, 367, 368, 369, 372, 366-BC, 372-BC, 373-BC, 374-BC, 366E, 372E, 366E-BC, 372E-BC	200	95	360	150	100	95
		150	82	310	150	75	90
		100	67	254	150	50	75
		200	95	360	250	100	95
		150	82	310	250	75	90
		100	67	254	250	50	75
203-125 222-125	366, 367, 368, 369, 372, 366-BC, 372-BC, 373-BC, 374-BC, 366E, 372E, 366E-BC, 372E-BC	200	125	475	150	100	100
		150	108	408	150	75	90
		100	88	333	150	50	75
		200	125	475	300	100	100
		150	108	408	300	75	90
		100	88	333	300	50	75
205-250	368, 374, 368-BC, 374-BC	200	250	950	200	100	120
		150	217	821	200	75	110
		100	177	670	150	50	80

Notes

* Total flow when picking up 6% foam concentrate through metering valve.

[^] Maximum hose lay from eductor discharge to nozzle.

These figures are with foam solution flowing and the nozzle set on straight stream.



THREAD INFORMATION

These tables outline the most commonly used threads. However, Protek has the ability to cut many other threads required by the fire service. Generally, there is no extra charge for these unique threads.

Style	National Standard (NH)		Straight Iron Pipe (NPSH)		New York FD (FDNY)		New York Corp (NYC)		Pacific Coast (PCT)		Chicago Fire Dept. (CFD)		British Standard (BSP)	
	ODM	TPI	ODM	TPI	ODM	TPI	ODM	TPI	ODM	TPI	ODM	TPI	ODM	TPI
3/4"	1.375	8	1.0353	14					1.0625	11			1.041	14
1"	1.375	8	1.295	11.5	1.66	8			1.3125	11.5			1.309	11
1-1/2"	1.99	9	1.8788	11.5	2.1	8	2.093	11	2.1	11	1.933	11.5	1.882	11
2"	2.515	8	2.3528	11.5			2.561	11	2.55	10			2.347	11
2-1/2"	3.068	7.5	2.841	8	3.03	8	3	8	3.046	7.5	2.99	7.5	2.96	11
3"	3.6239	6	3.47	8									3.46	11
3-1/2"	4.2439	6	3.97	8							4.052	8		
4"	5.0109	4	4.47	8							5.011	4	4.45	11
4-1/4"	5.7609	4	4.97	8							5.761	4	4.95	11
5"	6.26	4	5.53	8							6.26	4	5.45	11
6"	7.025	4	6.59	8									6.45	11

Canadian Standard 2-1/2" Hose Threads			
Code	Description	ODM	TPI
AMA	Albert Mutual Aid	2.99	8
BCT	British Columbia	3	8
CSA	Canadian Standards Association - Ontario	3.125	5
QST	Province of Quebec Standard	3.031	7
WCT	Western Canada Fire Underwriters	3.25	6
NDC	Nova Scotia - Zones 1	3.234	5

ABBREVIATION DEFINITIONS

ODM – outside diameter of male
TPI – threads per inch

THREAD DESIGNATIONS

National Hose – NH or NHT;
also called National Standard Thread (NST)
National Pipe Straight Hose – NPSH;
also called Straight Iron Pipe Thread (SIPT)
National Pipe Thread – NPT;
also called Tapered Iron Pipe Thread (TIPT)
British Standard Parallel Pipe – BSPP
British Standard Pipe Taper – BSP

Flange Specifications					
	2-1/2" ANSI 150#	3" ANSI 150# DN80 PN20	4" ANSI 150# DN100 PN20	DN80 PN16	DN100 PN16
Outside Diameter	7"	7.5" 190.5mm	9" 230mm	200mm	220mm
Thickness	0.75"	0.75" 20mm	0.94" 23mm	22mm	22mm
Bolt Hole Circle	5.5"	6" 152.5mm	7.5" 190.5mm	160mm	180mm
Number of Bolts	4	4	8	8	8
Size of Bolts	5/8"	5/8"	5/8"	16mm	16mm

Please contact us on support@protektfire.com.tw to check availability of a specific thread on your product.



METRIC CONVERSION

Liquid Volume		
To Convert	Into	Multiply By
Ounces (oz)	Mililiters (ml)	29.57
Pints (pt)	Liters (l)	0.4732
Quarts (qt)	Liters (l)	0.9464
Gallons (gal)	Liters (l)	3.785
Mililiters (ml)	Ounces (oz)	0.0338
Liters (l)	Pints (pt)	2.113
Liters (l)	Quarts (qt)	1.057
Liters (l)	Gallons (gal)	0.2642

Solid Volume - Weight		
To Convert	Into	Multiply By
Ounces (oz)	Grams (g)	28.3495
Pounds (lb)	Kilograms (kg)	0.4536
Grams (g)	Ounces (oz)	0.035
Kilograms (kg)	Pounds (lb)	2.205

Pressure		
To Convert	Into	Multiply By
Pounds per Square inch (psi)	Kilopascals (kPa)	6.895
Pounds per Square inch (psi)	bar	0.06895
Kilopascals (kPa)	Pounds per Square inch (psi)	0.145
Kilopascals (kPa)	bar	0.01
bar	Pounds per Square inch (psi)	14.503
bar	Kilopascals (kPa)	100

Length		
To Convert	Into	Multiply By
inches (in)	Milimeters (mm)	25.4
inches (in)	Centimeters (cm)	2.54
Feet (ft)	Centimeters (cm)	30.48
Yards (yd)	Meters (m)	0.914
Miles (mi)	Kilometers (km)	1.609
Milimeters (mm)	inches (in)	0.039
Centimeters (cm)	inches (in)	0.394
Meters (m)	Yards (yd)	0.094
Kilometers (km)	Miles (mi)	0.6214

Area		
To Convert	Into	Multiply By
Square inches (sq in)	Square Centimeters (cm ²)	6.425
Square feet (sq ft)	Square Meters (m ²)	0.093
Square Yards (sq yd)	Square Meters (m ²)	0.836
Square Miles (sq mi)	Square Kilometers (km ²)	2.59
Square Centimeters (cm ²)	Square inches (sq in)	0.155
Square Meters (m ²)	Square feet (sq ft)	1.196
Square Kilometers (km ²)	Square Yards (sq yd)	0.386

Pressures	
50 psi = 345 kPa = 3.45 bar	300 psi = 2069 kPa = 20.69 bar
60 psi = 414 kPa = 4.14 bar	350 psi = 2413 kPa = 24.13 bar
70 psi = 488 kPa = 4.88 bar	400 psi = 2758 kPa = 27.58 bar
75 psi = 517 kPa = 5.17 bar	450 psi = 3103 kPa = 31.03 bar
80 psi = 552 kPa = 5.52 bar	500 psi = 3448 kPa = 34.48 bar
90 psi = 621 kPa = 6.21 bar	550 psi = 3792 kPa = 37.92 bar
100 psi = 690 kPa = 6.9 bar	600 psi = 4137 kPa = 41.37 bar
150 psi = 1034 kPa = 10.34 bar	650 psi = 4482 kPa = 44.82 bar
200 psi = 1379 kPa = 13.79 bar	700 psi = 4827 kPa = 48.27 bar
250 psi = 1723 kPa = 17.23 bar	

Tip Sizes	
3/4" Tip = 19 mm	1-1/2" Tip = 38 mm
7/8" Tip = 22 mm	1-3/4" Tip = 45 mm
1" Tip = 25 mm	2" Tip = 50 mm
1-1/8" Tip = 28 mm	2-1/4" Tip = 57 mm
1-1/4" Tip = 32 mm	2-1/2" Tip = 64 mm
1-3/8" Tip = 35 mm	3" Tip = 76 mm

Hose Sizes	
1" Hose = 25.4 mm	4" Storz = 100mm
1.5" Hose = 38.1 mm	4" Storz = 101.60mm
1.75" Hose = 44.5 mm	4.5" Storz = 114.30mm
2" Hose = 63.5 mm	5" Storz = 125.00mm
2.5" Hose = 63.5 mm	5" Storz = 127.00mm
3" Hose = 76.2 mm	6" Storz = 152.40mm
3.5" Hose = 88.9 mm	

Flow Rate		
12 gpm =	45.42 lpm =	45 lpm
13 gpm =	49.20 lpm =	50 lpm
20 gpm =	75.70 lpm =	75 lpm
23 gpm =	87.06 lpm =	90 lpm
25 gpm =	94.62 lpm =	95 lpm
30 gpm =	113.55 lpm =	115 lpm
40 gpm =	151.40 lpm =	150 lpm
50 gpm =	189.25 lpm =	190 lpm
55 gpm =	208.18 lpm =	210 lpm
60 gpm =	227.10 lpm =	230 lpm
70 gpm =	264.95 lpm =	265 lpm
75 gpm =	283.88 lpm =	285 lpm
85 gpm =	321.73 lpm =	320 lpm
95 gpm =	359.58 lpm =	360 lpm
100 gpm =	378.50 lpm =	380 lpm
120 gpm =	454.20 lpm =	460 lpm
125 gpm =	473.13 lpm =	475 lpm
150 gpm =	567.75 lpm =	550 lpm
175 gpm =	662.38 lpm =	660 lpm
200 gpm =	757.00 lpm =	750 lpm
250 gpm =	946.25 lpm =	950 lpm
300 gpm =	1135.50 lpm =	1140 lpm
350 gpm =	1324.75 lpm =	1325 lpm
375 gpm =	1419.38 lpm =	1420 lpm
400 gpm =	1514.00 lpm =	1525 lpm
450 gpm =	1703.25 lpm =	1700 lpm
500 gpm =	1892.50 lpm =	1900 lpm
700 gpm =	2649.50 lpm =	2660 lpm
750 gpm =	2838.75 lpm =	2900 lpm
800 gpm =	3028.00 lpm =	3030 lpm
1000 gpm =	3785.00 lpm =	3800 lpm
1200 gpm =	4542.00 lpm =	4500 lpm
1250 gpm =	4731.25 lpm =	4800 lpm
1500 gpm =	5677.50 lpm =	6000 lpm
2000 gpm =	7570.00 lpm =	7600 lpm

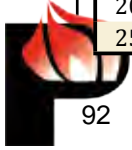

STYLE NUMBER INDEX

Style	Page	Style	Page	Style	Page	Style	Page
100	35	203-95	79	314	15	366E	29
101	35	203-125	79	314-TP	15	366E-TO	29
101-BC	35	204	32	320	44	366E-BC	29
102	35	205-250	80	321	16	366E-BCTO	29
102-BC	36	208	34	322	16	366-F	23
103	36	209	34	322-SP	16	366-K	5
104	36	210	34	323	17	366-L	5
105	37	211	34	323-DP	17	367	5
106	37	212	37	324	17	367-TO	5
109	56	213	34	324-TP	17	367-BA	5
111	39	214	34	325	11	367-BC	5
112	37	215	34	326	11	367-BI	5
115	37	216	34	332	13	368	6
117	37	217	34	333	13	368-TO	6
118	37	218	34	350	23	368-BA	6
119	56	219	34	352	23	368-BC	6
119-BC	56	220	34	355	24	368-BCTO	6
120	37	221	56	356	24	368-BCTP	7
121	37	222-60	80	357	24	368-BI	7
129	39	222-95	80	360	3	368-TP	7
130	36	222-125	80	360-TO	3	369	6
130-BC	36	225	34	360-BA	3	369-TO	6
132	36	226	34	360-BC	3	369-BA	6
133	39	227	34	360-BCTO	3	371	19
133-BC	39	236	31	361	3	371-TO	19
135	39	238	32	361-TO	3	371-BC	19
137	39	277	33	361-BC	3	371-BCTO	19
139	39	279	33	361-BCTO	3	372	19
140	70	280	33	361-F	23	372-TO	19
150	39	302	26	362	4	372-BA	19
155	38	303	26	362-TO	4	372-BC	19
162	38	304	26	362-BC	4	372-BC	42
176	38	305	26	362-BCTO	4	372-BCTO	19
178	38	306	26	366	4	372E	30
182	38	307	41	366-TO	4	372E-TO	30
190	67	308-3	45	366-BA	4	372E-BC	30
191	39	308-6	45	366-BC	4	372E-BCTO	30
196	64	309	41	366-BC	42	372-F	23
201-60	79	310	15	366-BCTO	4	373	20
201-95	79	311	15	366-BCSP	42	373-TO	20
203-60	79	312	15	366-BI	5	373-BA	20



STYLE NUMBER INDEX

Style	Page	Style	Page	Style	Page	Style	Page
373-BC	20	611	59	833	51	887	55
374	20	612	59	835	52	887-BC	55
374-BC	20	620	66	835-BC	52	888	55
374-BC	42	622-1	65	837-BC	52	888-BC	55
374-TP	21	622-2	65	845	50	889	56
374-BCTP	21	622-3	66	845-BC	50	889-BC	56
375	21	625-1	68	846	47	911	69
375-TO	21	625-2	68	846-BC	47	916	69
379	44	633	62	847	47	918	69
382	43	636	60	847-BC	47	922	71
385	43	648	60	848	47	933	73
386	43	649	61	848-BC	47	935	74
387-BC	27	655	62	849	47	955	74
388-BC	27	656	67	849-BC	47	IRCS	76
390	7	660	63	855E	53	2360	9
392	44	661	63	881	54	2361	9
396	7	699	70	881-BC	54	2365	9
505	81	736	61	883	54	2366	9
506	81	814	45	883-BC	54	2368	9
510	82	817E	53	886	55	2368-TP	9
520	81	818	49	886-BC	55		
520-BC	81	818-BC	49				
530	81	818E	53				
540	81	819	49				
540-BC	81	819-BC	49				
541	82	819E	53				
542	82	820	49				
545	83	820-BC	49				
545-BC	83	820E	53				
550	82	822	50				
555	83	822-BC	50				
560	70	823	50				
585	83	823-BC	50				
587	82	824	50				
595	83	824-BC	50				
596	83	825	52				
600-1	64	825-BC	52				
600-2	64	830	51				
605	58	832	51				

Accessories		Page
DC Power Supply		72, 75
Drum Pickup Kit		56
Electric Valve		72, 75
Pistol Grips & Handles		40
Isolation Valve		56
Nozzle Base & Teeth		40
Quick Connection		72
Terminal Board		72, 75
Touch Screen Control Panel		75
Wire or Wireless Joystick Control		75

Technical Data		Page
Compatibility Chart		89
Eductor/Nozzle Performance Data		90
Flow & Reach Data		85-88
Metric Conversion		92
Service Kits		84
Thread Information		91



LIMITED WARRANTY

Protek Manufacturing Corp., No 226, Sec 4 Chang Ping Rd, Daya District, Taichung City 42850, Taiwan ("Warrantor") warrants to the original purchaser of the new fire protection equipment manufactured by Warrantor, and to anyone to whom it is transferred, that the equipment shall be free from defects in material and workmanship during the five (5) year period (electrical components one [1] year*) commencing upon the receipt of such equipment by the original purchaser.

Warrantor's obligation under this warranty is specifically limited to replacing or repairing its equipment or parts which are shown by Warrantor's examination to be in a defective condition attributable to Warrantor. To qualify for this limited warranty, the claimant must return the equipment to Warrantor, at its above address, transportation charges prepaid, within a reasonable time after discovery of an alleged defect. Warrantor will examine the equipment. If Warrantor determines that there is a defect attributable to it, Warrantor will correct the problem within a reasonable time. If the equipment is covered by this limited warranty, Warrantor will assume the expenses of repair, except for transportation charges and shipping expenses incurred in delivering such equipment to Warrantor.

If any defect attributable to Warrantor under this limited warranty cannot be reasonably cured by repair or replacement, Warrantor may elect to refund the purchase price of the equipment, less reasonable depreciation, in complete discharge of its obligations under this limited warranty. If Warrantor makes this election, the claimant shall return the equipment to Warrantor free and clear of any liens and encumbrances.

This is a limited warranty. The original purchaser of the equipment, any person to whom it is transferred, and any person who is an intended or unintended beneficiary of the equipment, shall not be entitled to recover from Warrantor any consequential or incidental damages for injury to person and/or property resulting from any defective equipment manufactured or assembled by Warrantor.

Warrantor shall have no obligation under this limited warranty if the equipment is, or has been, misused or neglected (including failure to provide reasonable maintenance) or if there have been accidents to the equipment or if it has been repaired or altered by someone else.

THIS IS A LIMITED EXPRESS WARRANTY ONLY. WARRANTOR EXPRESSLY DISCLAIMS WITH RESPECT TO THE EQUIPMENT ALL IMPLIED WARRANTIES OF MERCHANTABILITY AND ALL IMPLIED WARRANTIES OF FITNESS FOR A PARTICULAR PURPOSE. THERE IS NO WARRANTY OF ANY NATURE MADE BY WARRANTOR BEYOND THAT STATED IN THE DOCUMENT.

Warrantor reserves the right to change the parts or design of its products from time to time without notice, and with no obligation to maintain spare parts or to make corresponding changes in the products previously manufactured.

* The following products carry a 1-year warranty:
Style 625-1, 625-2, 911, 916, 922, 933, 935 and 955.

Protek is proud to be ISO 9001:2008 registered with the internationally recognised Underwriter Laboratories Inc.(UL)





PROTEK MANUFACTURING CORP.

High Performance Fire Fighting Equipment

Handline Nozzles

- ◆ Selectable, Multi-Purpose, Constant, Automatic, and Multi-Mode and Retractable Foam Nozzles
- ◆ High Pressure, Low Pressure and Shockless Nozzles
- ◆ Ball Shutoffs, Playpipes and Smooth Bore Tips
- ◆ Nozzle Base, Teeth, Handles and Accessories

Speciality Nozzles

- ◆ Wildand/Forestry, Marine, Flashover, Electric and Deicing Nozzles
- ◆ Piercing Applicators and Industrial Fog Nozzle

Monitor Nozzles

- ◆ Selectable, Adjustable Flow-Baffle, Constant and Automatic Monitor Nozzles
- ◆ Electric Control Monitor Nozzles
- ◆ Monitor Nozzle Accessories and Stream Shaper

Monitors

- ◆ Industrial and Stationary Monitors
- ◆ Portable, Dual- Purpose and Oscillating Monitors
- ◆ Integrated Remote Control System
- ◆ Wireless and Cable Remote Control Monitors
- ◆ Monitor Accessories, Ball-Valve Shutoff and Hydrant Mount

Foam Equipment

- ◆ Self-Educting Handline and Monitor Nozzles
- ◆ Dual-Flow Foam, Dual-Agent and Dry Chemical Nozzles
- ◆ Foam Aeration Tubes for Handline and Monitor Nozzles

Valves

- ◆ Two-Way, Three-Way and Multi-Purpose Wyes
- ◆ Water Thief with Self-Locking Handles
- ◆ Suction and Clappered Siamese
- ◆ Hydrant and Gate Valves

Head Office & Manufacturing Facilities

No. 226, Sec. 4 Chang Ping Road, Daya District
Taichung City 42850, Taiwan
Tel: +886-4-2567-2111
Fax: +886-4-2567-0098

Contact Us

Customer Sales: sales@protektfire.com.tw
Customer Service: support@protektfire.com.tw
Technical Support: technical@protektfire.com.tw
Skype: proteksales