

TreadClimber[®]
by **BOWFLEX**

TC20



Manual en Español Latino Americano: <http://support.nautilus.com>

Owner's Manual

Welcome to TreadClimber® by Bowflex®!

You are about to experience a transformation that will not only shape your body but will also change your outlook on life. We thank you for investing your time and money in your TreadClimber® fitness machine. We are so confident in your purchase that we guarantee your results. If you don't see results in the first six weeks, you can get your money back (less shipping and handling) – guaranteed (see “100% Satisfaction Guarantee”).

Use this Owner's Manual as a guide to getting started on your TreadClimber® workouts and for tips to keep your machine well maintained.

Yours in Health,
The Bowflex® Family

Table of Contents

Important Safety Instructions	3	Leveling Your Machine.....	31
Safety Warning Labels and Serial Number	5	Maintenance	32
Specifications and Features	8	Walking Belt Alignment.....	35
Operations.....	16	Walking Belt Electrostatic Reduction	36
Before You Start	24	Troubleshooting.....	40
Moving Your Machine	30	100% Satisfaction Guarantee.....	43

To validate warranty support, keep the original proof of purchase and record the following information:

Serial Number _____ **Date of Purchase** _____

To register your product warranty, go to: www.bowflex.com/register

Or call 1 (800) 605–3369.

If you have questions or problems with your product, please call 1 (800) 605–3369.

Nautilus, Inc., (800) NAUTILUS / (800) 628-8458, www.NautilusInc.com - Customer Service: North America (800) 605-3369, tcinquiry@nautilus.com | outside U.S. +01-360-859-5180, technics-APLA@nautilus.com | Printed in China | © 2011 Nautilus, Inc., All rights reserved. ™ and ® indicate a trademark or registered trademark. Nautilus, Inc. (www.NautilusInc.com) trademarks include NAUTILUS®, BOWFLEX®, SCHWINN®, TreadClimber® and UNIVERSAL® and respective logos. Other trademarks are the property of their respective owners.



This icon means a potentially hazardous situation which, if not avoided, could result in death or serious injury.

Before using this equipment, obey the following warnings:



Read and understand the complete Owner's Manual. Keep the Owner's Manual for future reference.

Read and understand all Warnings on this machine. If at any time the Warning stickers become loose, unreadable or dislodged, contact Nautilus® Customer Service for replacement stickers.

⚠ DANGER

To reduce the risk of electrical shock or unsupervised usage of the equipment, always unplug the power cord from the wall outlet and/or the machine and wait 5 minutes before cleaning, maintaining or repairing the machine. Place the power cord in a secure location.

⚠ WARNING

To decrease the risk of burns, electric shock, or injury to persons, read and understand the complete Owner's Manual. Failure to follow these guidelines can cause a serious or possibly fatal electrical shock or other serious injury.

- Children must not be let on or near to this machine. Moving parts and other features of the machine can be dangerous to children.
- Not intended for use by anyone under 14 years of age.
- Consult a physician before you start an exercise program. Stop exercising if you feel pain or tightness in your chest, become short of breath, or feel faint. Contact your doctor before you use the machine again. Use the values calculated or measured by the machine's computer for reference purposes only.
- Before each use, examine this machine for damage to power cord, power receptacle, loose parts or signs of wear. Do not use if found in this condition. Contact Nautilus® Customer Service for repair information.
- The machine should never be left unattended when plugged in. Unplug from outlet when not in use, and before putting on or taking off parts.
- Keep power cord away from heat source and hot surfaces.
- This machine must be connected to an appropriate, dedicated electrical circuit. Nothing else must be connected to the circuit.
- Always connect the power cord to a circuit capable of handling 10 amperes with no other loads applied.
- Connect this machine to a correctly grounded outlet; consult a licensed electrician for assistance.
- Do not operate where aerosol products are being used.
- Do not let liquids touch the electronic controller. If it does, the controller must be inspected and tested for safety by an approved technician before it can be used again.

Important Safety Instructions

- 
- The electrical wiring for the residence in which the machine will be used must obey the applicable local and provincial requirements.
 - Maximum user weight limit: 300 lbs. (136 kg). Do not use if you are over this weight.
 - This machine is for home use only.
 - Do not wear loose clothing or jewelry. This machine contains moving parts. Do not put fingers or other objects into moving parts of the exercise equipment.
 - Always wear rubber soled athletic shoes when you use this machine. Do not use the machine with bare feet or only wearing socks.
 - Set up and operate this machine on a solid, level, horizontal surface.
 - Use caution when you step on and off the machine. Use the supplied foot support platforms for stability before walking on the moving belt.
 - The normal design and operation of this machine allows for the treadles to move independently of each other when a person steps on, or exerts force or pressure, on the treadles. Be aware that treadle movement can occur when the machine is unplugged or the safety key removed. Always take care to insure that fingers do not get caught between the treadles, and to prevent injury never allow children or pets around the machine.
 - Do not operate this machine outdoors or in moist or wet locations.
 - Keep at least 19.5" (1/2 m) on each side of the machine and 79" (2 m) behind the machine clear. This is the recommended safe distance for access and passage around and emergency dismounts from the machine. Keep third parties out of this space when machine is in use.
 - Do not over exert yourself during exercise. Operate the machine in the manner described in this manual.
 - Perform all regular and periodic maintenance procedures recommended in the Owner's Manual.
 - Read, understand, and test the Emergency Stop Procedure before use.
 - Keep the walking belt clean and dry.
 - Do not drop or put objects into any opening of the machine.
 - This machine is designed for walking. Do not try to run on this machine.
 - Keep your hands on the support Handlebars and stay as near the front of the machine as is comfortable in order to stay in balance on the Treadles.
 - Keep your foot in the center of each Treadle, do not let your feet cross in front of your body as you increase the speed.
 - Use this machine only for its intended use as described in this manual. Do not use attachments not recommended by the manufacturer.

FAILURE TO OBEY THESE SAFEGUARDS CAN CAUSE SERIOUS INJURY OR HEALTH PROBLEMS.

⚠️ WARNING

1. Keep children and pets away from this machine at all times.
2. When this machine is not in operation, remove the Safety Key and keep out of the reach of children.
3. Use Caution when you operate this equipment or serious injury can occur.
4. Prior to use, read and understand the Owners Manual, including all Warnings.
5. To prevent injury, stand on the Foot Platforms before you start the machine.
6. This machine is for Residential use only.
7. The Maximum user Weight for this machine is 300lbs. / 136kgs.
8. Replace any Warning label that becomes damaged, illegible or is removed.
9. Not intended for use by anyone under 14 years of age

⚠️ WARNING

HAZARDOUS VOLTAGE.

Contact may cause electrical shock or burn.

Turn off and lock out power before servicing.



* under Motor Cover

⚠️ WARNING

- Keep hands and feet away.

⚠️ AVERTISSEMENT

- Gardez les mains et les pieds loin.

004-0930

* on inside of Treadles

CAUTION ATTENTION

Unplug power cord before you move the machine.

Débranchez le cordon d'alimentation avant de déplacer la machine.

002-2268

**CALIFORNIA 93120 PHASE 2
COMPLIANT FOR
FORMALDEHYDE**

FABRICATOR

MM/YYYY

003-8597_C

Serial Number

AAAAAABBPPPPPLCCCC



18225 NE Riverside Parkway, Portland, Or. 97230
www.nautilus.com
Model: TC20
Rating: 120 VAC, 60Hz - 10A
Made in: China



NAUTILUS®

0000
004-0963_A

⚠️ WARNING

-Moving parts can crush and cut.

-Keep guards in place.

-Lock out power before servicing.



* under Motor Cover



Grounding Instructions

This product must be electrically grounded. If a malfunction occurs, correct grounding decreases the risk of electric shock. The power cord is equipped with an equipment-grounding conductor, and must be connected to an outlet that is properly installed and grounded.

⚠ DANGER The electrical wiring must comply with all applicable local and provincial standards and requirements. Incorrect connection of the equipment-grounding conductor can result in a risk of electric shock. Consult a licensed electrician if you are not sure that the machine is correctly grounded. Do not change the plug on the machine – if it does not fit the outlet, have a correct outlet installed by a licensed electrician.

If you connect the machine to an outlet with GFI (ground fault interrupt) or AFI (arc fault interrupt), machine operation can cause the circuit to trip.



If an extension cord or surge protector is used with this machine, make sure that it is a heavy duty model rated at 15A operation, and accepts an equipment-grounding conductor. Do not connect other appliances or devices to the extension cord or surge protector in combination with this machine.

Make sure that the product is connected to an outlet having the same configuration as the plug. No adapter should be used with this product.



Emergency Stop Procedure (Safety Key Port)

The TreadClimber® machine is equipped with a Safety Key that can prevent serious injury, as well as prevent children from playing with and/or being injured on the machine. If the Safety Key is not correctly inserted into the Safety Key Port, the belts will not operate.



Always attach the Safety Key Clip to your clothing during your workout.

When you use the machine, only remove the Safety Key in an emergency. When the key is removed while the machine is in operation, it will stop quickly, which could cause the loss of balance and possible injury.

For safe storage of the machine and to prevent unsupervised operation of the machine always remove the Safety Key and disconnect the power cord from the wall outlet and the AC input. Place the power cord in a secure location.

The Console will display “EStP” for a Safety Key fault. The TreadClimber® machine will pause a workout when the Safety Key is removed. Inspect the Safety Key and be sure it is connected to the Console correctly. Push the START button to resume the workout.



Specifications and Features



Maximum User Weight: 300 lbs (136 kgs)

Power Requirements:
 Operational Voltage: 120VAC 60 Hz
 Operating Current: 10A max

Regulatory Approvals: c-ETL-us mark. Evaluated per UL 1647 Fourth Edition, January 2008 and CAN/CSA-C22.2. 68-92.



Console

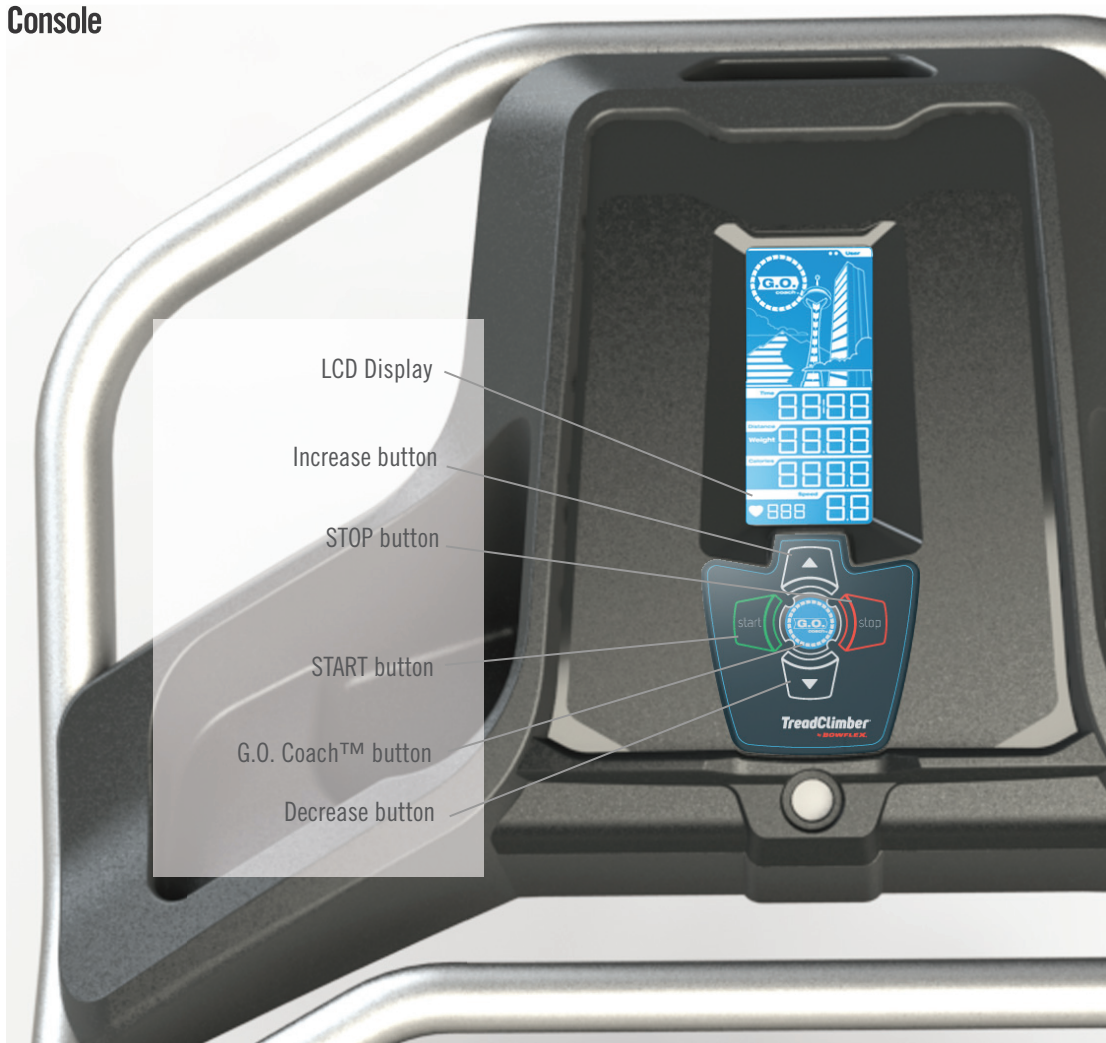

Decrease button

Push to lower the speed of the belts, decrease a value, select a User, or scroll through a list of options

G.O. Coach™ button

Push to start a G.O. Coach™ workout, or push and hold for 2 seconds to configure a G.O. Coach™ user profile.

Specifications and Features

START button

Push to wake up the machine, begin a Quick Start workout, to select an option, to resume a paused workout, or to enter information. Push and hold for 2 seconds to set up a Custom Quick Start workout.

STOP button

Push to pause a workout, to exit an option, or push again while paused to end a workout.

Increase button

Push to increase the speed of the belts, increase a value, select a G.O. Coach™ user, or scroll through a list of options

LCD Display

User Profile display

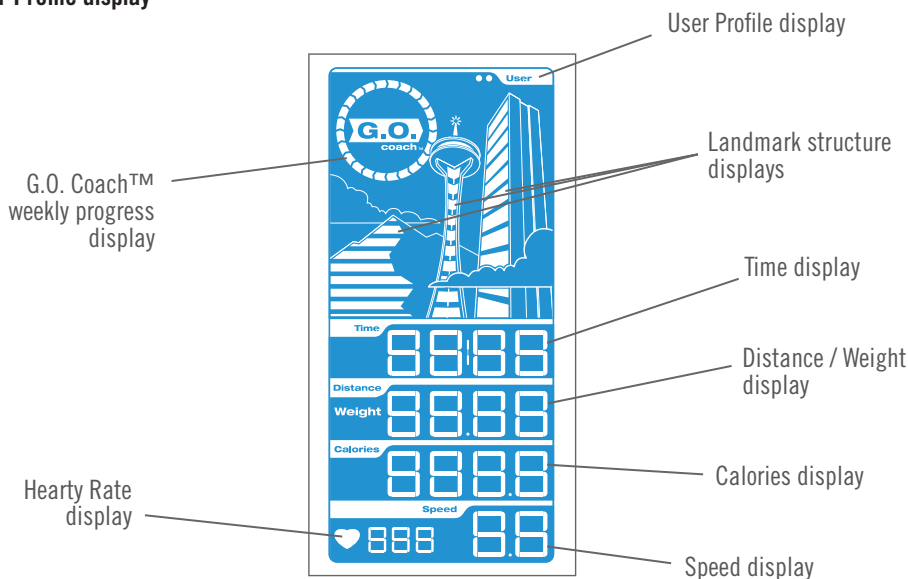

Displays which G.O. Coach™ user profile is selected (one circle= first user, two circles= second).

Note: The User Profile display is not shown unless in a G.O. Coach™ workout.

Landmark structure displays

Three landmark structures (a mountain, tower, and a building) segmented into blocks to show your workout progress.



Time display

Counts in minutes and seconds the total time of your workout (e.g. 24:22 minutes). During a Quick Start workout, the Time display will count up from “00:00”. For a Custom Quick Start or G.O. Coach™ workout, the Time display will count down.

Note: The maximum display value for Time is 99:59.

The default time value is thirty minutes.

Distance / Weight display

Shows your workout distance in miles (MI) or kilometers (KM).

Note: When you workout a distance more than “99.99”, the value will reset to “00.00”. During the set up of a G.O. Coach™ user, the Weight value will be displayed.

The default value for a distance goal is 1.5 miles, and the default value for Weight is 150 lbs.

Calories display

Counts your total calories used. The default value for a calorie goal is 450 calories.

Note: When you reach “9999”, the Calorie display will rollover to a value of “0”. Be sure to add the 10,000 rollover calories to your workout results.

Speed display

Shows your climbing rate in miles (MPH) or kilometers (KPH) per hour to one decimal (e.g. 3.2 MPH). MPH is the default setting.

Note: The maximum speed is 4.5 mph (7.2 kph).

Heart Rate display

Shows your estimated heart rate in beats per minute when you correctly wear the heart rate transmitter chest strap. On detection of a heart rate signal, three horizontal dashes will flash as the heart rate value is calculated.

Note: The HR (Heart Rate) display will be blank if no signal is detected for 10 seconds.

G.O. Coach™ weekly progress display

Shows the progress of a G.O. Coach™ user toward their weekly goal.

Note: The progress display is only shown when a G.O. Coach™ user is selected.

Hydraulic Workout Cylinder

Your TreadClimber® machine uses Hydraulic Cylinders to absorb your steps and cushion your joints, decreasing your overall fatigue and reducing muscle strain. The displacement of the Treadles is adjusted by the dials on the Hydraulic Cylinders. The MIN setting is the minimum amount of Treadle movement, the MAX is the maximum movement. The closer the dial is set to the MAX setting, the more the Treadle will travel. This results in a more intense workout.

Begin with each cylinder set to the central, white dot on the dial. If this setting allows too much Treadle travel, adjust the dial toward the MIN (clockwise) setting until you are comfortable with the amount of travel. If you find that the Treadles do not move enough to fully cushion your steps, adjust the dial setting toward the MAX (counter-clockwise) setting, allowing more Treadle movement. The Treadles should be set so they displace enough to absorb the impact of your stepping motion, approximately 3 inches. Although the settings dial can move continuously in either direction, it is recommended not to turn the dials through the red range.

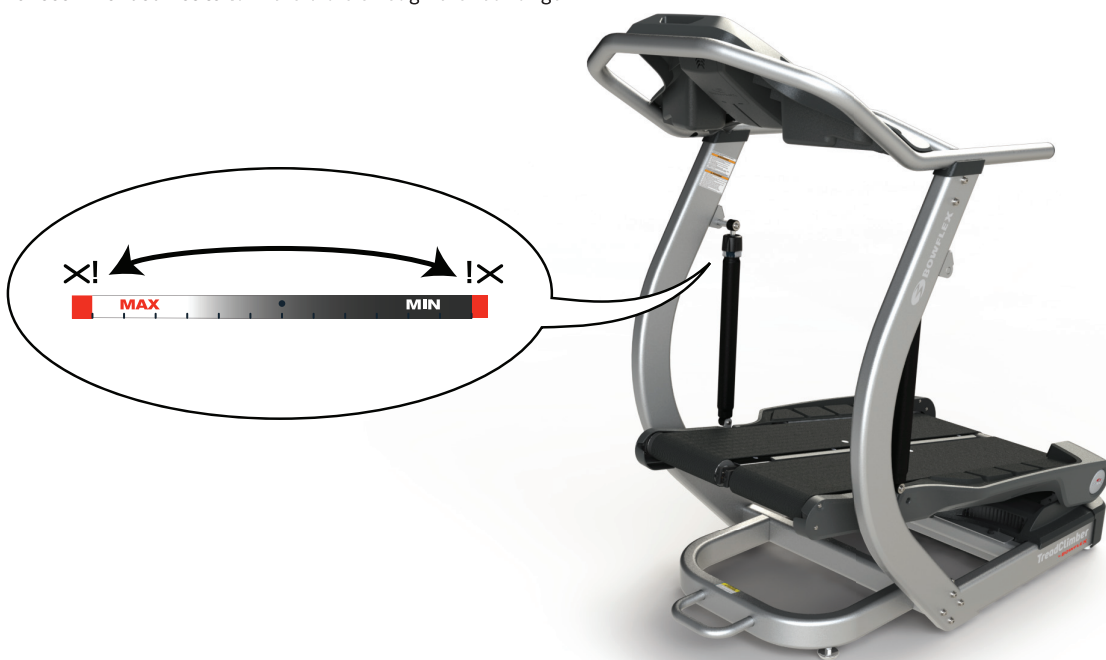

Do not change the intensity settings of the Cylinders during a workout. Stop the workout and step off the machine before you adjust the resistance level.

Note: “Bottoming out” occurs when the Treadle travels through too great a range of motion. When this occurs, the Treadles hit against the base on the down step. To reduce Treadle travel, turn the setting dial toward MIN or increase the belt speed.

It may be helpful to note your dial setting for future reference when there are multiple users of the machine.



Remote Heart Rate Monitor

Monitoring your Heart Rate is one of the best procedures to control the intensity of your exercise. The Console reads the telemetry HR signals from the Heart Rate Chest Strap Transmitter that operates in the 4.5kHz - 5.5kHz range.

Note: The heart rate chest strap must be an uncoded heart rate strap from Polar Electro or an uncoded POLAR® compatible model. (Coded POLAR® heart rate straps such as POLAR® OwnCode® chest straps will not work with this equipment.).



If you have a pacemaker or other implanted electronic device, consult your doctor before using a wireless chest strap or other telemetric heart rate monitor.

Chest Strap

Using the heart rate transmitter chest strap lets you monitor your heart rate at any time during your workout.



Consult a physician before you start an exercise program. Stop exercising if you feel pain or tightness in your chest, become short of breath, or feel faint. Contact your doctor before you use the machine again. Use the values calculated or measured by the machine's computer for reference purposes only.

The heart rate transmitter is attached to a chest strap to keep your hands free during your workout. To put on your chest strap:

1. Attach the transmitter to the elastic chest strap.
2. Adjust the strap length to fit snugly and comfortably against your skin. Secure the strap around your chest, just below the chest muscles, and buckle it.
3. Lift the transmitter off your chest and moisten the two Grooved Electrode Areas on the back.
4. Check that the wet electrode areas are firmly against your skin.

The transmitter will send your heart rate to the machine's receiver and display your estimated Beats Per Minute (BPM).

Always remove the transmitter before you clean the chest strap. Clean the chest strap regularly with mild soap and water, and thoroughly dry it. Residual sweat and moisture may keep the transmitter active and drain the battery in the transmitter. Dry and wipe clean the transmitter after each use.

Note: Do not use abrasives or chemicals such as steel wool or alcohol when you clean the chest strap, as they can damage the electrodes permanently.

If the Console does not display a heart rate value, the transmitter may be at fault. Check that the textured contact areas on the chest strap are making contact with your skin. You may need to lightly wet the contact areas. If no signal appears or you need further assistance, call your Nautilus® Representative.



Heart Rate Calculations

Your maximum heart rate usually decreases from 220 Beats Per Minute (BPM) in childhood to approximately 160 BPM by age 60. This fall in heart rate is usually linear, decreasing by approximately one BPM for each year. There is no indication that training influences the decrease in maximum heart rate. Individuals of the same age could have different maximum heart rates. It is more accurate to find this value by getting a stress test than by using an age related formula.

Your at rest heart rate is influenced by endurance training. The typical adult has an at rest heart rate of approximately 72 BPM, where as highly trained runners may have readings of 40 BPM or lower.

The Heart Rate table is an estimate of what Heart Rate Zone (HRZ) is effective to burn fat and improve your cardiovascular system. Physical conditions vary, therefore your individual HRZ could be several beats higher or lower than what is shown.

The most efficient procedure to burn fat during exercise is to start at a slow pace and gradually increase your intensity until your heart rate reaches between 60 – 85% of your maximum heart rate. Continue at that pace, keeping your heart rate in that target zone for over 20 minutes. The longer you maintain your target heart rate, the more fat your body will burn.

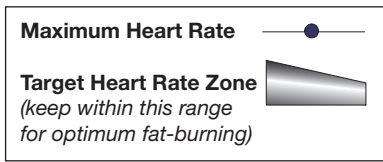
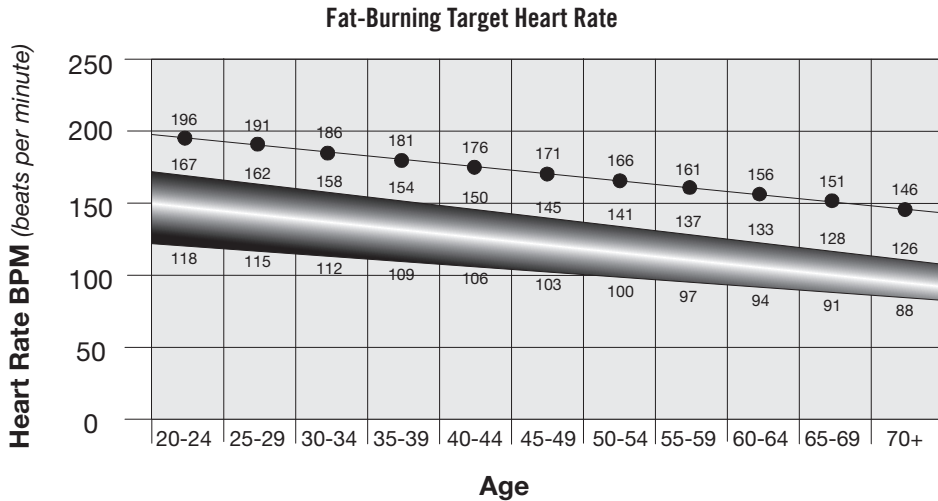

The graph is a brief guideline, describing the generally suggested target heart rates based on age. As noted above, your optimal target rate may be higher or lower. Consult your physician for your individual target heart rate zone.

Note: As with all exercises and fitness regimens, always use your best judgment when you increase your exercise time or intensity.



Fitness Basics

Frequency

To maintain good health, lose weight and improve your cardiovascular endurance, use the TreadClimber® fitness machine a minimum of 3 times per week, 30 minutes each day.

If you are new to exercise (or returning to a regular exercise program), and you are unable to comfortably complete 30 minutes of continuous exercise at one time, just do 5 – 10 minutes, and gradually increase your workout time until you can reach 30 minutes total.

If your schedule is busy, and you are unable to fit 30 minutes of continuous exercise into your day, try accumulating 30 minutes by doing multiple shorter workouts on the same day. For example, 15 minutes in the morning and 15 minutes in the evening.

For best results, combine your TreadClimber® fitness machine workouts with a strength training program using a Bowflex® home gym or Bowflex® SelectTech® dumbbells, and follow the Bowflex® Body Weight Loss Plan that comes with your machine.

Consistency

Busy work schedules, family obligations and daily chores can make it difficult to fit regular exercise into your life. Try these tips to increase your chances of success:

Schedule your workouts the same way you schedule meetings or appointments. Select specific days and times each week, and don't change your workout times unless it is absolutely necessary.

Make a commitment to a family member, friend or spouse, and encourage each other to stay on track each week. Leave messages with friendly reminders to be consistent, and keep each other accountable.

Make your workouts more interesting by alternating between steady state (single-speed) workouts and interval training (varied speed) workouts. The TreadClimber® fitness machine is even more fun when you add this kind of variety.

Apparel

It is important to wear appropriate, safe and comfortable footwear and clothing when using the TreadClimber® fitness machine, including:

- Rubber-soled athletic walking or running shoes.
- Exercise clothing that allows you to move freely, and keep comfortably cool.
- Athletic support that provides stability and comfort.

Warm-Up *

Before you use your TreadClimber® fitness machine, consider doing these dynamic warm-up stretches, which will help prepare your body for the workout:



Dynamic Knee Hug

Stand with the feet together. Bring one knee forward and up toward the chest. Place the hands around the shin and pull the knee into the chest. Release the stretch by putting the foot on the floor. Each repetition of the sequence should take 1 to 3 seconds. Repeat as a continuous, controlled, fluid sequence 10 or 20 times. Repeat the stretch with the other leg.

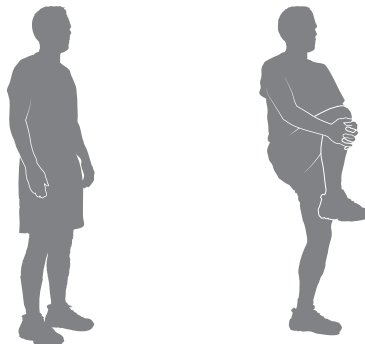

Dynamic Knee Bend

Stand with the feet together. Raise the heel of one foot toward the gluteals. Release the stretch by putting the foot on the floor. Each repetition of the sequence should take 1 to 3 seconds. Repeat as a continuous, controlled, fluid sequence 10 or 20 times. Repeat the stretch with the other leg.

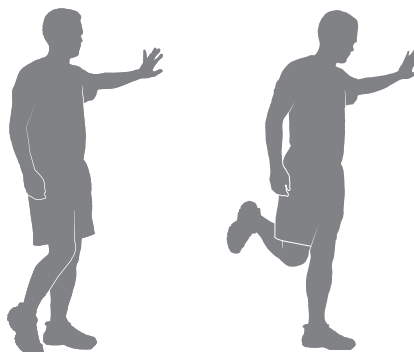

Dynamic Knee Kick

Stand tall and hold one leg up with the hands at hip height, keeping the knee bent. Hold onto a wall for balance with one hand, if necessary. Straighten the knee as far as comfortably possible. Release the stretch by bending the knee. Each repetition of the sequence should take 1 to 3 seconds. Repeat as a continuous, controlled, fluid sequence 10 or 20 times. Repeat the stretch with the other leg.

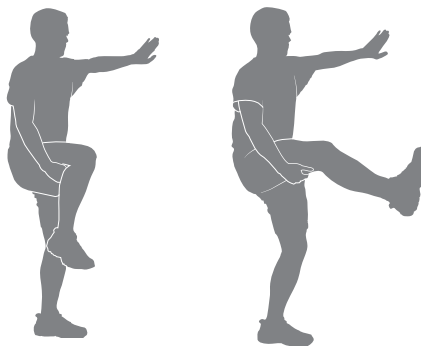

Dynamic Twist

Stand with the feet shoulder-width apart. Bend the elbows; hold the arms out to the sides. Twist the upper body to one side and then the other side as far as comfortably possible. Each repetition of the sequence should take 1 to 3 seconds. Repeat as a continuous, controlled, fluid sequence 10 or 20 times

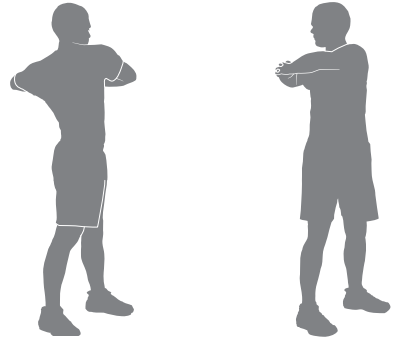

Dynamic Bent Knee Heel Press

Stand with one foot forward and one foot back, hip-width apart and feet facing forward. Bend both knees putting weight on the back heel. Release the stretch by returning to the start position. Each repetition of the sequence should take 1 to 3 seconds. Repeat as a continuous, controlled, fluid sequence 10 or 20 times. Repeat the stretch with the other leg. Touch a wall or hold onto something for balance, if necessary.

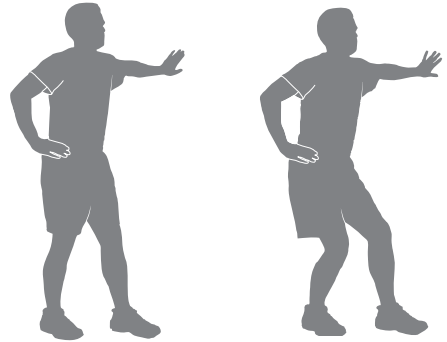

Dynamic Side Reach

Stand with the feet apart, the knees slightly bent and the arms at the sides of the body. Reach with one hand above the head and lean over to the opposite side. Release the stretch by returning to the start position. Then reach with the other hand to the opposite side. Use the other arm to support the body weight on the thigh, if necessary. Each repetition of the sequence should take 1 to 3 seconds. Repeat as a continuous, controlled, fluid sequence 10 or 20 times.

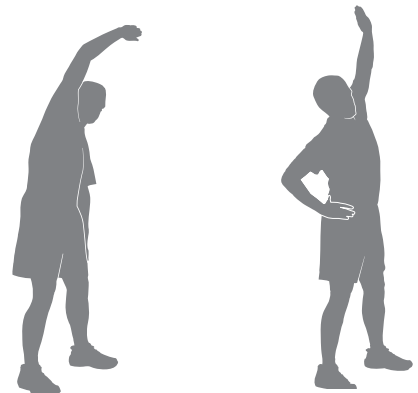

* Source: Jay Blahnik's Full-Body Flexibility, Second Edition, 2010. HumanKinetics.com.



Workouts

Follow these guidelines to ease yourself into a weekly exercise regimen. Use your judgment and/or the advice of your physician or health care professional to find the intensity and level of your workouts.



Consult a physician before you start an exercise program. Stop exercising if you feel pain or tightness in your chest, become short of breath, or feel faint. Contact your doctor before you use the machine again. Use the values calculated or measured by the machine's computer for reference purposes only.

Steady State and Interval Training are 2 types of workouts you can do on your TreadClimber® fitness machine:

Steady State workouts

A Steady State workout involves slowly increasing your workout speed to a challenging, but comfortable speed you can hold for most of your workout. For example, holding a 3.0 MPH walking pace for the entire workout, except during the warm-up and cool-down. Steady State workouts help you build exercise confidence, stamina and endurance, and are essential to a well-rounded cardiovascular training program.

Interval Training workouts

An Interval Training workout involves adjusting your speed faster and slower for specific lengths of time to raise and lower your breathing rate, heart rate and calorie burn. Here is a sample Interval Training workout:

- 7 minutes walking at a slow, easy, comfortable speed.
- 1 minute walking at a more challenging speed that is approximately 50% faster.
- 7 minutes walking at a slow, easy, comfortable speed.
- 1 minute walking at a more challenging speed that is approximately 2x faster.
- 7 minutes walking at a slow, easy, comfortable speed.
- 1 minute walking at a more challenging speed that is approximately 50% faster.
- 6 minutes walking at a slow, easy, comfortable speed.

Interval Training workouts provide variety, help minimize overuse injuries (that sometimes occur from doing only Steady State workouts), maximize calorie burn and improve fitness.

The TreadClimber® fitness machine is designed to cushion your joints and muscles, and both Steady State and Interval Training workouts should feel much more comfortable than walking or running outside on a hard surface or a treadmill.



Workout Schedule

Here is a beginner, intermediate and advanced sample workout schedule. With each of these sample workout schedules, do not move on to the next week until the current week feels easier and comfortable.

Beginner	Week 1	Week 2	Week 3	Week 4	Week 5
	Steady State	Steady State	Steady State	Interval Training	Interval Training
	Steady State	Steady State	Interval Training	Steady State	Steady State
	Steady State	Steady State	Steady State	Interval Training	Interval Training

Intermediate	Week 1	Week 2	Week 3	Week 4	Week 5
	Steady State	Steady State	Interval Training	Steady State	Interval Training
	Steady State	Interval Training	Steady State	Interval Training	Steady State
	Steady State	Steady State	Interval Training	Steady State	Interval Training

Advanced	Week 1	Week 2	Week 3	Week 4	Week 5
	Steady State	Interval Training	Interval Training	Interval Training	Interval Training
	Interval Training	Steady State	Steady State	Steady State	Interval Training
	Steady State	Interval Training	Interval Training	Interval Training	Interval Training

Cool-Down *

When you are done using your TreadClimber® fitness machine, consider doing these relaxing stretches, which will help your body recover from the workout and make you more flexible:

Lying Leg Raise

Lie on the floor face up with the legs slightly bent. Lift one leg up toward the ceiling, keeping the knee straight. Place the hands (or a strap) around the thigh and move the leg closer to the head. Hold the stretch for 10 to 30 seconds. Repeat the stretch on the other leg. Keep the head on the floor and do not round the spine.

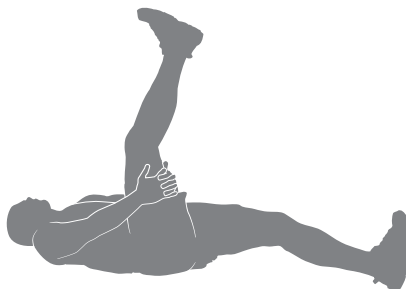

Side Lying Knee Bend

Lie on the floor on one side of the body and rest the head on the lower arm. Bend the top knee and hold the ankle with the same-side hand, then pull the heel toward the gluteals. Hold the stretch for 10 to 30 seconds. Lie on the other side and repeat the stretch with the other leg. Remember to hold the knees close together.

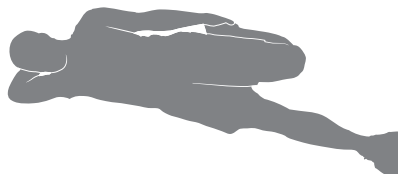

Lying Figure Four

Lie on the floor face up with the legs bent. Place one foot across the thigh of the opposite leg in the figure four position. Reach for the leg on the floor and pull it toward the chest. Hold the stretch for 10 to 30 seconds. Repeat the stretch with the other leg. Keep the head on the floor.

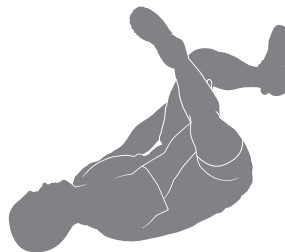

* Source: Jay Blahnik's Full-Body Flexibility, Second Edition, 2010. HumanKinetics.com.



Seated Twist

Sit on the floor and extend the legs straight out in front of the body with the knees slightly bent. Place one hand on the floor behind the body and the other hand across the thigh. Twist the upper body as far as comfortably possible to one side. Hold the stretch for 10 to 30 seconds. Repeat the stretch on the other side.



Seated Figure Four

Sit on the floor and extend one leg straight out in front of the body. Place the foot of the other leg across the thigh in the figure four position. Move the chest toward the legs, pivoting at the hip. Hold the stretch for 10 to 30 seconds. Repeat on the other leg. Use the arms to support the back.



Dynamic Heel Drop

Place the ball of one foot on the edge of a step or staircase. Place the other foot slightly in front. Lower the heel of the back foot as far as comfortably possible, keeping the knee straight. Release the stretch by lifting the heel as high as comfortably possible. Each repetition of the sequence should take 1 to 3 seconds. Repeat as a continuous, controlled, fluid sequence 10 or 20 times. Repeat the stretch with the other leg.

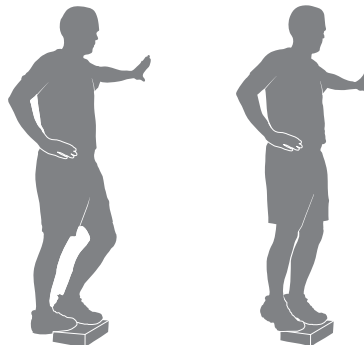

Before You Start

1. Place the TreadClimber® fitness machine in your workout area.



Place the machine on a clean, hard, level surface, free from unwanted material or other objects that may hamper your ability to move freely. A rubber mat can be used below the machine to prevent the release of static electricity and protect your flooring.

The machine can be moved by one or more persons. Make sure that your own physical strength is capable of safely moving the machine.

2. Adjust the intensity settings on the Hydraulic Cylinders.

Note: Initially, the settings on each cylinder should match. Begin with each cylinder set to the central, white dot on the dial.

3. Examine below the Treadles for any objects. Be sure it is clear below the machine.

4. Connect the power cord to the machine and into a grounded AC Wall Outlet.



Put the power cord alongside the machine, out of your way when you dismount the machine. Avoid stepping on the power cord and plug.

Note: The TreadClimber® fitness machine is designed to plug directly into a properly wired and grounded three prong 120V outlet. If an extension cord must be used, be sure it is a heavy duty model, rated for 15A.

5. If you use the Heart Rate Monitor, follow the Remote Heart Rate Monitor directions.

6. Switch on the power. Power is now supplied to the motor and Console.

7. Straddle the belts and stand on the Side Foot Support Platforms. Put the Safety Key into the Safety Keyhole and clip the Safety Key cord to your clothing.

- Examine the Safety Key and be sure it is connected to the Console correctly.
- Always attach the Safety Key Clip to your clothing during workouts.
- If there is an emergency, pull out the Safety Key to shut off the power to the Belt Motor. This will quickly stop the belts (brace yourself- this is an abrupt stop).



8. Select your workout, push START, and begin your workout when the belts are up to speed.



The belts will only move after a 3 second, audible beep countdown.

Keep your hands on the support Handlebars and stay as near the front of the machine as is comfortable in order to stay in balance on the Treadles.

Keep your foot in the center of each Treadle, do not let your feet cross in front of your body as you increase the speed.

When you are experienced and comfortable with the action of the machine, you may wish to allow your arms to swing freely in a natural walking motion. This workout will activate your core muscles. It should only be done by those comfortable with not holding on to the Handlebars.

Power Up / Idle Mode

The TreadClimber® machine will enter Power Up / Idle Mode when power is supplied, the power switch is ON, and the START button is pushed.



The belts will only move after a 3 second, audible beep countdown.

Auto Shut-Off (Sleep Mode)

If the Console does not receive any input for five minutes, it will go into Sleep Mode and shut off. All workout values will be cleared.

Note: The Console does not have an On/Off switch.

Push the START button to start (wake up) the Console.

Quick Start Workout

With the Quick Start Workout, you have 30 minutes to work your way to the top of a landmark structure. During the workout, your progress is updated on a landmark structure display. If you workout past the 30 minutes, the landmark structure will clear and allow you to climb it again. The next landmark structure will be activated for a new workout.

To begin a Quick Start workout, push the START button from Idle Mode. After a 3 second, audible countdown, the workout will begin.

Note: Be sure to read and follow the “Before You Start” section of your manual.



Custom Quick Start Workout

The Console allows you to customize the Quick Start workout for time, distance, or calories. The new, custom workout value will be applied to the segments of the landmark structure.

1. Push and hold the START button for 2 seconds from Idle Mode.
2. Use the Increase or Decrease buttons to select either a Time, Distance or Calorie workout, and push START.
3. Adjust the workout value with the Increase and Decrease buttons. This will be the new, custom workout value.

The default workout values are: Time = 30:00 minutes, Distance = 1.5 miles, Calories = 450 calories.

4. Push START. Your Custom Quick Start Workout will begin after the three second, audible beep countdown.

Note: Quick start workouts do not count toward the weekly, G.O. Coach™ goals.

G.O. Coach™ User Profiles

The G.O. Coach™ Console allows you to create two personal, user profiles to record and display your progress toward your G.O. Coach™ weekly goals. With a user profile created, the Console will track all your G.O. Coach™ Workouts for the week.

To create a G.O. Coach™ User Profile, push and hold the G.O. Coach™ button for 2 seconds.



1. Select which User Profile to customize with the Increase and Decrease buttons (one circle= User 1, two circles= User 2), and push START.
2. The Weight value will be shown in the Distance display. Use the Increase or Decrease buttons to adjust it, and push START.
3. Use the Increase or Decrease buttons to select your preferred type of workout (Time, Distance or Calories), and push START.
4. Use the Increase or Decrease buttons to adjust the weekly workout value.

The default weekly workout values are: Time = 90:00 minutes, Distance = 4.5 miles, Calories = 1350 calories. When adjusted, push the START button to save the new workout value.

To exit the G.O. Coach™ custom menu, push STOP at any point.

If you are tracking your workouts toward a weekly goal, be sure to always select your user profile before you workout. Your workout values will not count toward your goal if you do not select the user profile.

G.O. Coach™ Workout

The G.O. Coach™ Workout is a programmable, goal oriented workout. The goal is to climb the three landmark structures (a mountain, a tower, and a building) weekly. As you work out, your progress on the current landmark structure is displayed with landmark segments. The Console records your G.O. Coach™ Workout values, so you can stop a workout and continue it at a later time.

The G.O. Coach™ Weekly Progress Display provides a quick visual summary of where you are on your weekly goal. As you workout, segments on the progress display are shown. When all of the segments are shown, you have completed your weekly goal. If you workout past your weekly goal, the display will show your progress with a flashing segment.

Note: To set the day when your workout week begins, see the “Set Time Reference” option in the Console Service / Setup Mode section.

To start a G.O. Coach™ Workout, you must have a G.O. Coach™ User Profile.

1. Push the G.O. Coach™ button.
2. Use the Increase and Decrease buttons to select your User Profile (one circle= User 1, two circles= User 2) and push START.
3. Use the Increase or Decrease buttons to select either a Time, Distance or Calorie workout, and push START.

The default workout values are: Time = 30:00 minutes, Distance = 1.5 miles, Calories = 450 calories.

4. Adjust the workout value with the Increase and Decrease buttons.
5. Push START. After a 3 second, audible countdown, your G.O. Coach™ Workout will begin.

Note: Be sure to read and follow the “Before You Start” section of your manual.

Pausing or Stopping

1. With a firm hold on the Handlebars, step off of the belts and onto the Side Foot Support Platforms on either side of the Treadles.
2. Push STOP to pause the workout. The belts will slow to a complete stop.

Note: If a paused workout is not restarted in 5 minutes, the machine will shut down and clear all workout values.

To restart your workout, push the START button. To end your workout, push STOP again. The Console will display your results.



To prevent unsupervised operation of the machine always remove the Safety Key and disconnect the power cord from the wall outlet and the AC input. Place the power cord in a secure location.

Results

When a workout ends, the Console will show your workout results. They are shown in sequence (time, distance, calories, average heart rate, and average speed) three times.

Console Service / Setup Mode

The Console has a Service / Setup Mode. Some options in the Service / Setup Mode can be adjusted to your preferences, but most are helpful for service of the machine. To access the Service / Setup Mode, hold down the Increase and Decrease buttons for 2 seconds when in Idle Mode.

Order	Display	Option	Description
1	Unit	Units	Select your preferred unit of measurement; “Lb” = English Imperial, “SI” = metric
2	brt	Brightness	Control the brightness level of the Console; “20” = maximum intensity, “1” = minimum
3	LOG	Error Log *	Displays error codes, starting with the most recent
4	Con	Console Version *	Displays the Console software version
5	dr	Drive Version *	Displays the drive software version
6	HrS	Total Hours	Displays total number of hours and minutes used
7	diSt	Total Distance	Displays total distance
8	HiSt	Motor Current History *	Displays the average motor current for the current maintenance interval. Push the Decrease button to view the averages of previous intervals.
9	Hd	Hardware Type *	Displays the hardware type
10	Curr	Motor Current *	Displays the current of the motor
11	CoAS	Coast Time *	Tests to see how fast the the belts stop
12	LOOP	Loop Back *	Test to see if the Console is receiving data
13	Str	Set Time Reference	Sets the current day and time as the start of the workout week for all users
14	CSn	Console Serial Number*	Displays the serial number for the Console
15	dSn	Drive Serial Number *	Displays the serial number for the Motor Control Board
16	dES	Drive Error Statistics *	Displays the hard fault statistics experienced by the Console
17	Prog	Program Drive *	Updates the program of the USB Drive
18	USb	Write System Log *	Saves the system log to an attached USB Drive

* for Service Technicians

Use the Increase and Decrease buttons to cycle through the Options. To change the value of an Option, push START and use the Increase and Decrease buttons to select the new value. Push START to assign the new value to the Option.

Push STOP to exit an Option and the Service / Setup Mode.

Moving Your Machine

The TreadClimber® fitness machine weighs approximately 218 lbs (98.9 kg) when fully assembled and requires caution when being moved. Use the Transport Handle found under the front of the machine to move it. To get access to the Transport Handle, turn the Levelers until you have sufficient clearance between the machine and floor.

Use the transport wheels to roll your fitness machine to the new location. Lower your machine slowly into its new location without injury to your head or fingers.



Do not use the uprights, handlebars, or the Console to lift or move the machine. Injury to you or damage to the machine can occur.

The machine may be moved by one or more persons depending on their physical abilities and capacities. Make sure that you and others are all physically fit and able to move the machine safely.

Place the machine on a clean, hard, level surface, free from unwanted material or other objects that may hamper your ability to move freely. A rubber mat should be used below the machine to prevent the release of static electricity and protect your flooring.

For safe storage of the machine and to prevent unsupervised operation of the machine, always remove the Safety Key and disconnect the power cord from the wall outlet and the AC input. Place the power cord in a secure location.



Machine Mat

The Bowflex® TreadClimber® Machine Mat is an optional accessory that helps keep your workout area clear and adds a layer of protection to your floor. The rubber machine mat provides a non-slip, rubber surface which limits static discharge and reduces the possibility of display or running errors. If possible, put your Bowflex® TreadClimber® Machine Mat in your selected workout area before you begin assembly.

To order the optional machine mat, go to: www.bowflex.com, or call 1 (800) 605-3369.

Leveling Your Machine

Levelers are found on the front of the TreadClimber® machine. Make sure the TreadClimber® machine is level and stable before you exercise. To adjust:

1. Loosen the upper locking nut.
2. Turn the leveler to adjust the height.
3. Tighten the upper locking nut to lock the leveler.



Do not adjust the levelers to such a height that they detach or unscrew from the machine. Injury to you or damage to the machine can occur.

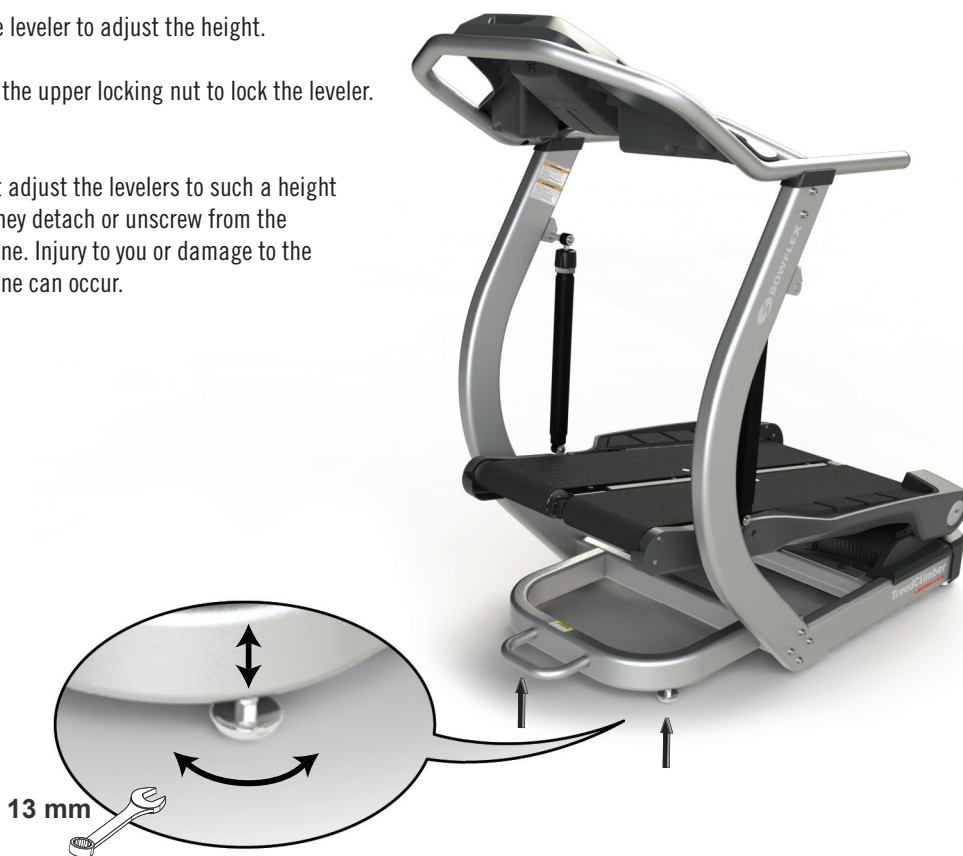

Read all maintenance instructions fully before you start any repair work. In some conditions, an assistant is required to do the necessary tasks.



Equipment must be regularly examined for damage and repairs. The owner is responsible to make sure that regular maintenance is done. Worn or damaged components must be repaired or replaced immediately. Only manufacturer supplied components can be used to maintain and repair the equipment.



This product, its packaging, and components contain chemicals known to the State of California to cause cancer, birth defects, or reproductive harm. This Notice is provided in accordance with California's Proposition 65. If you would like additional information, please refer to our web site at www.nautilus.com/prop65.

▲ DANGER To reduce the risk of electrical shock or unsupervised usage of the equipment, always unplug the power cord from the wall outlet and/or the machine and wait 5 minutes before cleaning, maintaining or repairing the machine. Place the power cord in a secure location.

Daily: Before each use, inspect for loose, broken, damaged, or worn parts. Do not use the machine if any of these conditions exist. Use a dry cloth to wipe off any perspiration after each use.

Weekly: Check for smooth roller operation. Clean the machine to remove dust, dirt, or grime. Clean the top of the belt with a slightly damp, soapy cloth and wipe carefully and thoroughly with a dry cloth. Do not let any liquid get below the belts or into the Base Frame.

Monthly: Make sure all bolts and screws are tight. Tighten if necessary.

NOTICE: Do not clean with a petroleum based solvent or an automotive cleaner. Be sure to keep the Console free of moisture.



Walking Belt and Deck Lubrication

The TreadClimber® machine is equipped with a low maintenance deck and belt system. Belt friction can affect the function and life of the machine. Your TreadClimber® fitness machine came with a starter supply of lubrication for the belts.

Lubrication Schedule

User Level	Total Workout Hours per Week	When to Lubricate
Light	less than 3 hours	every 3 months
Moderate	3 to 5 hours	every 2 months
Heavy	5 or more hours	every month

We recommend that you use one of the following:

- Lube-N-Walk® Treadmill Lubrication Kit (available from www.bowflex.com or your local specialty fitness dealer)
- 100% pure silicone, available at most hardware and auto parts stores.

As you use your fitness machine, the Console will show “LUB” at set times. This is only a reminder and should be added to your inspection schedule. Only apply lubricant as necessary. Push the START button to accept the reminder.

For the best results lubricate the Treadles periodically with a silicone lubricant, using the following instructions:

1. Unplug the machine fully from the wall outlet, and remove the power cord from the machine. Place the power cord in a secure location.
2. Carefully lift each belt and apply silicone lubricant in the center of the Treadle deck along the entire reachable length of the deck. Apply 0.5 to 1.5 oz. of the lubricant on the deck underneath each belt.

NOTICE: Always use a 100% pure silicone lubricant. Do not use a degreaser like WD-40® or a petroleum based product as this could seriously impact performance.

Note: The Walking Belts may need to be loosened to allow for access during lubrication. Consult the “Adjusting the Walking Belts” procedure if necessary.

3. Connect the power cord back into the machine and then into the wall outlet.
4. Stay to one side of your machine.

- 
5. Switch on your machine and start the belts at the slowest speed. Let the belts operate for approximately 15 seconds.
 6. Switch off your machine.
 7. Take care to clean up any excess lubricant from the Treadles. We also recommend a periodic inspection of the Treadle surfaces below the belts. If the decks appear worn, contact a TreadClimber® Representative (refer to the Contacts section of this manual).



To decrease the possibility of slipping, be sure the Treadle area is free from grease or oil. Clean off any excess oil from the machine surfaces.

Walking Belt Alignment

The walking belts need to be adjusted if they are out of center enough to cause a rubbing or scraping sound. Adjustments can be made at the Front Roller of each Treadle.

Adjusting the Walking Belts – While operating the machine, notice where the belts run on each Treadle. The Walking Belt Adjustment Bolts are on the front end of each Roller. If the belt is tracking too far to the right, use a properly sized Hex Key to turn the right adjustment bolt clockwise on that belt in full turn increments. If the belt tracks too far to the left, do the same thing on the left adjustment bolt.

Note: Do not turn the bolts counterclockwise when you adjust the belt alignment.

Belt Tension Check – Check the belt tension only when the machine is unplugged. From the belt's midpoint, a correctly tensioned belt should only have an inch of give. To check, pull the belt upward at its midpoint and measure the distance to the deck. If the distance is more than an inch, the belt is loose. To tighten, turn both Walking Belt Adjustment Bolts clockwise one-half a turn and check tension again. Repeat this step if necessary.

Note: Bolts are turned counterclockwise equally to decrease belt tension.

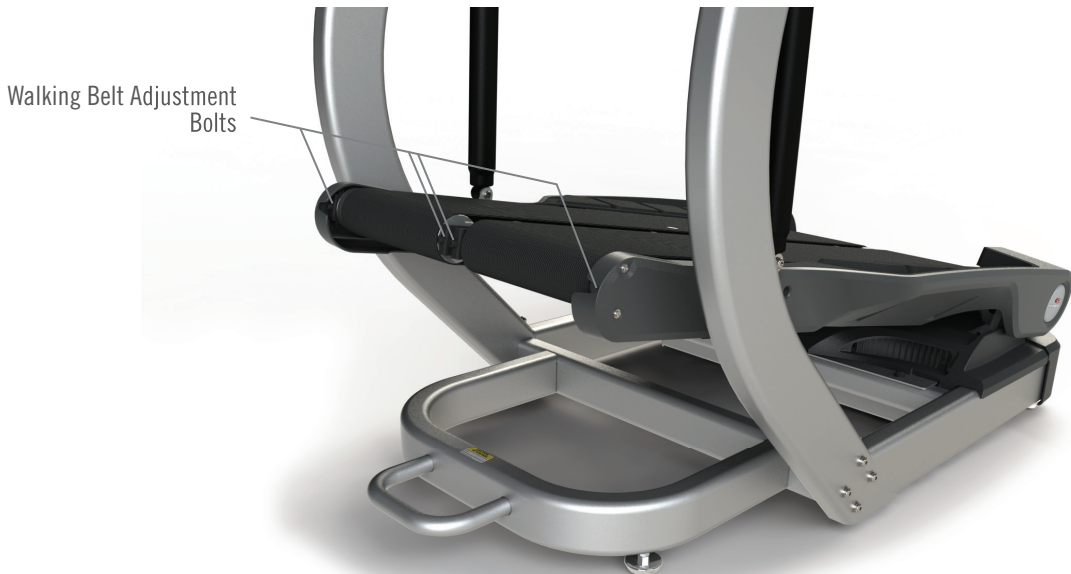

Walking Belt Electrostatic Reduction

Your TreadClimber® machine may develop a static charge caused by the movement of the walking belts. Follow this procedure to apply an anti-static spray to them to reduce the static electric charges.

 Wait a minimum of 60 minutes after the last workout before you apply the anti-static spray, to let hot electrical components cool to room temperature.

1. Unplug the machine from the wall.

▲ DANGER To reduce the risk of electrical shock or unsupervised usage of the equipment, always unplug the power cord from the wall outlet and/or the machine and wait 5 minutes before cleaning, maintaining or repairing the machine. Place the power cord in a secure location.

2. Using a 5 mm hex wrench, loosen the tension adjustment bolts for the walking belts to let them slide easily. Turn the bolts counterclockwise to decrease the tension.

Note: Be sure to record how many turns it takes to loosen the bolts to assist with reassembly.

3. Carefully apply the anti-static spray to lightly cover the top surface of the walking belts along the front of the machine, farthest from the motor (green highlighted area).

NOTICE: Hold the spray dispenser approximately 6" (13 cm) above the walking belt and point the spray toward the front of the machine, away from the motor. Apply the spray only on the belts, not on the deck or mechanism. If spray goes off the belts, wipe the excess spray off the other parts of the machine.

Note: Be sure to obey the manufacturer safety instructions for the anti-static product.

4. Using your foot, manually advance the walking belts toward the back of the machine, exposing the next unsprayed section.





5. Do steps 3 and 4 again until all sections of the belts are lightly coated with anti-static spray.
6. Wait until the belts dry fully (approximately 2-4 hours).
7. Using a 5 mm hex wrench, tighten the tension adjustment bolts for the walking belts. Turn the bolts clockwise to increase the tension.
8. Plug in the machine and turn on the power.
9. Inspect the walking belt alignment and tension before using the machine. Refer to the walking belt alignment and belt tension adjustment procedures.

Note: Repeat the procedure to apply anti-static spray if static electric discharge occurs again. The machine will accumulate more static electric charge when the surrounding air is drier. Be sure to obey the manufacturer safety instructions for the anti-static product.

Maintenance Parts

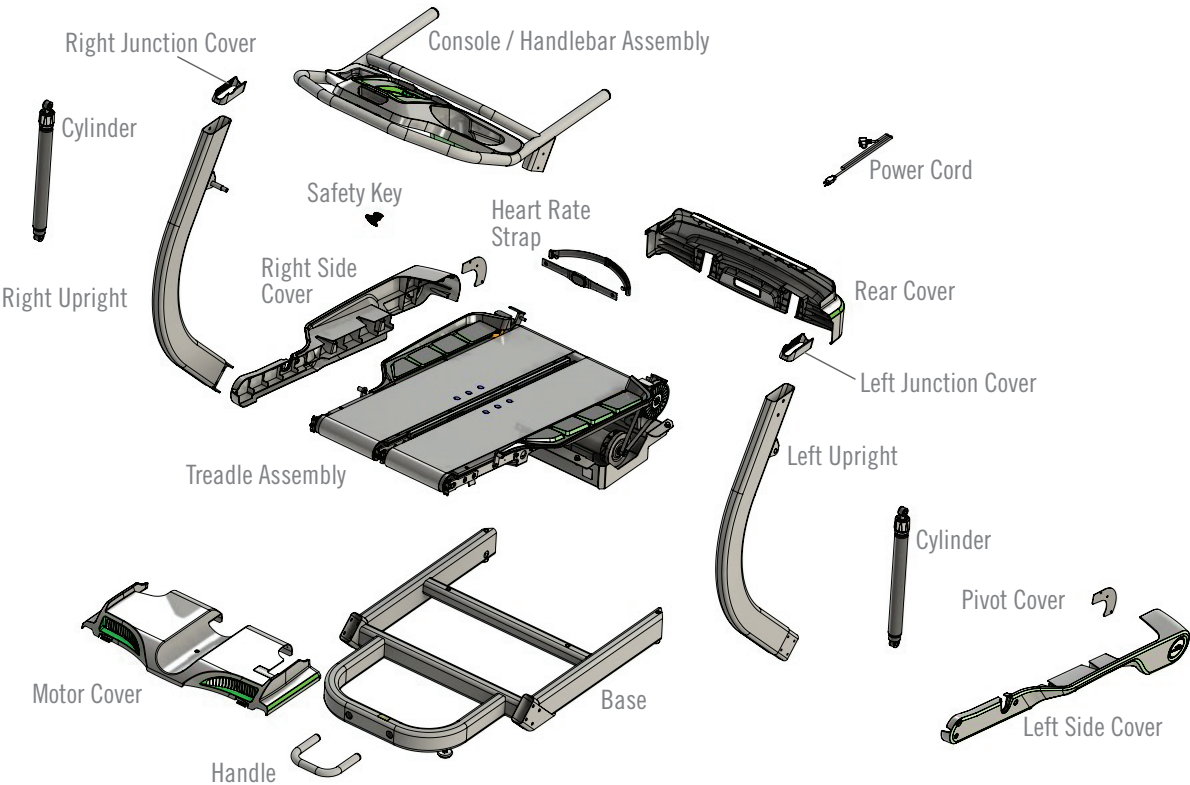



Maintenance Parts (Treadle Assembly)

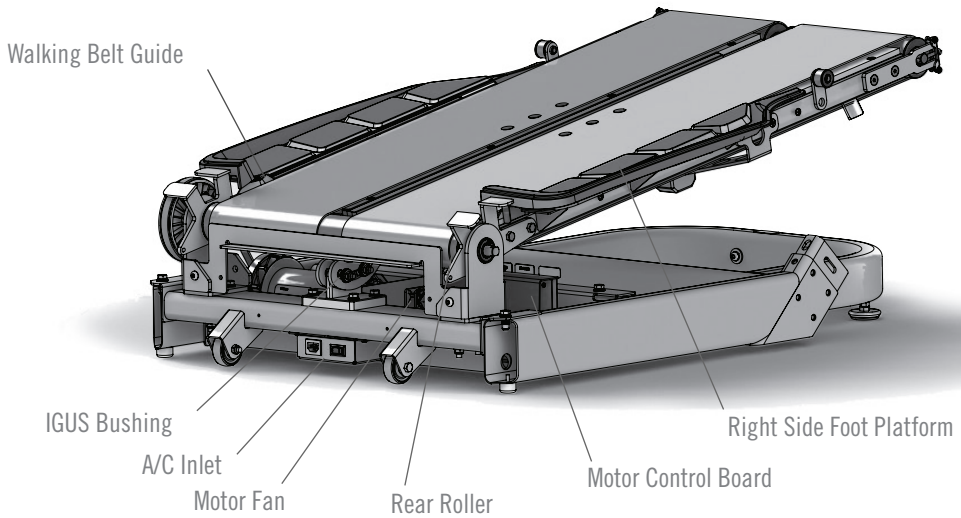
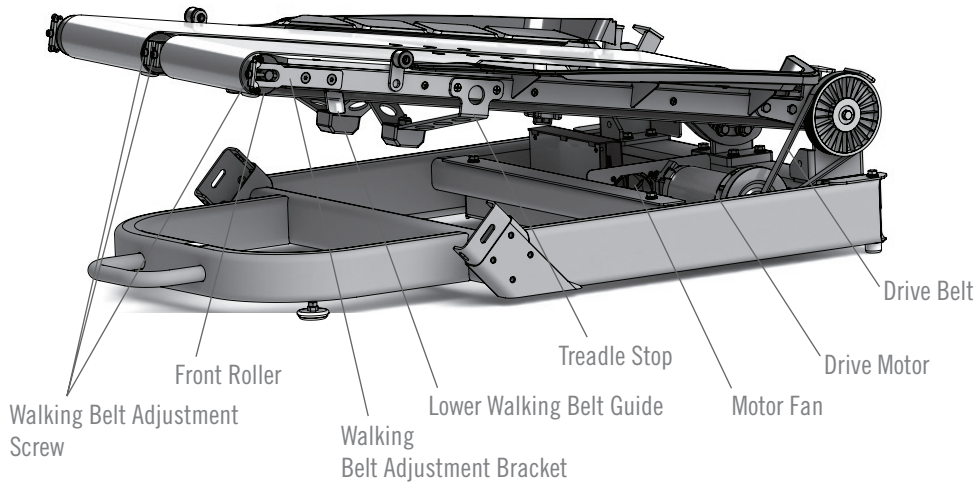



Condition/Problem	Things to Check	Solution
Unit will not turn on, power switch does NOT light up	Outlet	Make sure outlet is functioning correctly. Verify this by plugging another device (ex: lamp) into the outlet. If outlet is connected to a light switch, check to make sure it is on. If outlet is not functioning find a working outlet.
	Power cord not plugged in	Make sure the power cord is firmly secured to A/C inlet on the unit and firmly inserted into a non-GFI wall socket.
	Power switch turned off	Make sure the power switch at the rear of the unit is in the "ON" position. Switch will light up red to indicate power is present.
	Safety key not plugged in	Plug Safety Key into Console (See Safety Key - Emergency Stop Procedures within Features section).
Power switch is lit but display screen does not turn on	I/O Cable	Check I/O Cable connections at back of console. If display still will not light up, replace I/O Cable.
	If problem persists	Contact Customer Service.
Speed displayed is not accurate	Display set to wrong unit of measure. (English/Metric)	Change display units.
Console displays drive error code ("C", "S", or "H" with a number)	Unit needs to be restarted	Cycle power off for 10 seconds using power switch at rear of unit, then restart.
	Error code diagnostic	Contact Customer Service.
Console displays "LUbE" code	Belt lubrication	Consult lubrication schedule and apply if necessary. Push START button.



Condition/Problem	Things to Check	Solution
Heart rate not displayed while using chest strap	Transmitter not making good contact with skin	Moisten skin contact area on the chest strap.
	Electromagnetic interference	Turn off any television, AM radio, microwave, or computer within 6 feet (2 meters) of the fitness machine.
	Chest strap transmitter	Test chest strap with another HR monitoring device such as HR watch or a machine at a gym. If transmitter has good skin contact and still is not found to be emitting HR signal, replace chest strap transmitter.
	HR receiver	If chest strap is known to work with other devices and no sources of interference are present, or console has been tested with a Pulse Simulator and is not receiving the signal, contact Customer Care for replacement HR receiver.
Walking belt misalignment	Rear belt guides	Belts should ride on top of walking belt guides at the outside edge of treadles.
	Tracking adjustment	Belts are not required to be perfectly centered and are typically farther out in the rear than they are in the front. This may vary depending on user's stride. If belt is tracking to one side far enough to cause rubbing of belt, follow the "Adjusting the Walking Belts" procedure.
	If problem persists	Contact Customer Care for further assistance.
Speed dependent grinding or scraping noise	Belt alignment	Check walking belt alignment. Belt contact with metal guides under Treadle can make a loud grinding sound. If belts are misaligned, follow the "Adjusting the Walking Belts" procedure.
	Rollers or motor	Contact Customer Care for further assistance.



Condition/Problem	Things to Check	Solution
Knocking noises when unit is operating	IGUS bushing	If knocking sound seems to be coming directly from the rear roller, check IGUS (yellow “hat” shaped) bushings and replace if cracked.
	Hydraulic cylinder bolts	Check and tighten both upper and lower bolts that connect the hydraulic cylinders to the unit.
“Tick” sound once per revolution or scraping noise from under Treadle	Belt alignment	Belt seam may be contacting metal belt guide under treadle. Slight adjustment of belt should alleviate noise. Follow the “Adjusting the Walking Belts” procedure.
Belts stop turning while in use	Safety key	Plug Safety Key into Console (See Safety Key -Emergency Stop Procedures within Features section).
	Motor overload	Unit may be overloaded and drawing too much current, causing unit to shut power down to protect motor. Consult belt lubrication schedule to determine if belts need lubrication, check walking belt tension, and restart unit.
	Outlet	Outlet may not have enough power available for the machine due to other devices on same circuit. Remove any devices from power circuit and restart machine.



We want you to know that your TreadClimber® machine is a superior product. Your satisfaction is guaranteed. If, for any reason, you are not 100% satisfied with your TreadClimber® machine, please follow the instructions below to return your merchandise and receive a refund of the purchase price, less shipping and handling.

This TreadClimber® Satisfaction Guarantee applies only to merchandise purchased by consumers directly from Nautilus, Inc. This guarantee does not apply to sales made by dealers or distributors.

1. Call a TreadClimber® Representative at 1-800-605-3369 for a Return Authorization Number (RMA). An RMA will be granted if:
 - a. The TreadClimber® exercise machine was purchased directly from Nautilus, Inc.
 - b. The request to return the product is within 6 weeks of the delivery date of your merchandise.

2. If an RMA is granted, the following instructions will prevent delays in the processing of your refund.
 - a. The merchandise must be returned to the address given to you at the time of the Return Authorization Call.
 - b. All returned merchandise must be properly packaged in good condition, preferably in the original boxes.
 - c. The exterior of the boxes should be marked clearly with:
 - Return Authorization Number
 - Your Name
 - Your Address
 - Your Phone Number
 - d. Additionally, a piece of paper with your name, address and phone number or copies of your original invoice should be placed in each box of merchandise.
 - e. **Your RMA number is time sensitive.** Your shipment must be post marked within two weeks from the date the TreadClimber® Representative issued the Return Authorization Number.

Note: You are responsible for return shipping and for any damage or loss to merchandise that occur during return shipment. Nautilus recommends that you obtain tracking numbers and insure your shipment.

Unauthorized Returns

Nautilus, Inc. defines an unauthorized return as any merchandise returned to our facilities without a valid and current Return Merchandise Authorization (RMA) number issued by Nautilus. Failure to properly mark packages with a valid RMA number, or allowing an RMA number to expire, will cause Nautilus, Inc. to consider a return unauthorized. Any merchandise returned without a RMA number will not be subject to a refund or credit and Nautilus will discard the product. The customer assumes all shipping and handling charges for any unauthorized return.

TreadClimber[®]

by **BOWFLEX[®]**

Nautilus[®]

Bowflex[®]

Schwinn[®]

Universal[®]