

POWER BANKS STORAGE SYSTEM

User Manual

Version: 1.0

51.2V 280AH-14.34 Kwh

For On / Off Hybrid Solar Storage System



Meets Canadian code requirements for:
UL1973 and UL9540A/UL9540



EOD ALMIRUN

Contents

1. Safety Precautions	- 2 -
1.1. Before Connecting	- 2 -
1.2. During operation	- 2 -
2. Battery Specifications	- 3 -
3. Introduction to the battery	- 4 -
3.1. Key Features	- 4 -
3.2. Interface Introduction	- 4 -
3.3. SOC Indicator & Status Indicator Guides	- 6 -
3.4. Connectors	- 7 -
3.5. Wake Up button	- 7 -
3.6. Display function instruction	- 8 -
3.6.1. Reference of real figure	- 8 -
3.6.2. Screen Display	- 8 -
4. Safe handling guide	- 12 -
4.1. System Diagram	- 12 -
4.2. Tools	- 12 -
4.3. Safety Gear	- 13 -
5. Installation	- 13 -
5.1. Inventory of items	- 13 -
5.2. Installation Location	- 14 -
5.2.1. Minimum clearances	- 15 -
5.3. Installing the Battery Pack	- 15 -
5.3.1. Mounting to a wall	- 15 -
5.4. Parallel use of battery	- 17 -
5.4.1. Parallel use of battery (All off grid solar inverters)	- 17 -
5.4.2. Parallel use of battery on Canbus (All hybrid on-off grid solar inverters)	- 19 -
5.4.3. ADS guide Line	- 19 -
6. Product Warranty	- 22 -
6.1.	- 22 -
6.2.	- 22 -
6.3.	- 22 -
6.4. Factory Warranty Scope	- 22 -
6.5. Warranty conditions	- 22 -

1.Safety Precautions

- It is very important and necessary to read the user manual carefully before installing or using the battery. Failure to follow any of the instructions or warnings in this document can result in electrical shock, serious injury, death, or may damage the battery and the whole system.
- If the battery is stored for a prolonged time, it is requirement that they are charged every three to six months, and the SOC should be no less than 80%.
- The battery needs to be recharged within 12 hours, after fully discharging.
- Do not expose cable outside.
- All battery terminals must be disconnected before maintenance.
- Do not use cleaning solvents to clean the battery.
- Do not expose the battery to flammable or harsh chemicals or vapors.
- Do not paint any part of the battery, include any internal or external components.
- Do not connect battery with PV solar wiring directly.
- Any foreign object is prohibited to be inserted into any part of the battery.
- Any warranty claims are excluded for direct or indirect damage due to items above.

1.1.Before Connecting

- After unpacking, please check the battery and packing list first, if the battery is damaged or spare parts are missing, please contact the dealer.
- Before installation, be sure to cut off the grid power and make sure the battery is in the turned-off mode;
- Wiring must be correct, do not mix-connect the positive and negative cables, and ensure no short circuit with the external device;
- It is prohibited to connect the battery with AC power directly;
- The embedded BMS in the battery is designed for 48VDC, please DO NOT connect battery in series;**
- It is prohibited to connect the battery with different type of battery;**
- Please make sure battery SOC and Voltage should be the same level before paralleling two more batteries together.**
- Please ensure the electrical parameters of battery system are compatible to inverter;
- Keep the battery away from fire or water.

1.2.During operation

- If the battery system needs to be moved or repaired, the power must be cut off first and the battery is completely shutdown;
- It is prohibited to connect the battery with different type of battery;
- It is prohibited to put the batteries working with faulty or incompatible inverter;
- In case of fire, only dry powder fire extinguisher can be used, liquid fire extinguishers are prohibited;
- Please do not open, repair or disassemble the battery. We do not undertake any consequences or related responsibility due to violation of safety operation or violating of design, production and equipment safety standards.

2. Battery Specifications

Battery Specifications	
Model No	MOOSE48V280A
<i>Nominal Parameters</i>	
Voltage	51.2V
Capacity	280Ah
Energy	14.33Kwh
Dimensions (L x W x H)	900 x675x200mm
Weight	128.5kg
<i>Basic Parameters</i>	
Life time(25°C)	15 years
Life cycles(80% DOD, 25°C)	6500 Cycles
Storage time / temperature	5 months @ 25°C; 3 months @ 35°C; 1 month @ 45°C
Operation temperature	-20°C to 60°C @60+/-25% Relative Humidity
Storage temperature	0°C to 45°C @60+/-25% Relative Humidity
Lithium Battery Standard	UL1973, IEC62619,CE-EMC, UN38.3, MSDS
Enclosure protection rating	IP21
<i>Electrical Parameters</i>	
Operation voltage	51.2 Vdc
Max. charging voltage	56 Vdc
Cut-off Discharge Voltage	46 Vdc
Max. charging and discharging current	200A(10240W)

3.Introduction to the battery

3.1.Key Features

- LiFePO4 composition – provides exceptional safety and longevity
- High safety and reliability
- 6,500cycles/ 15 years' service life
- Consistent performance over wide temperature range
- Wall-mounted, convenient installation
- Integrated state-of-the-art BMS to manage and monitor battery information including voltage, current and temperature as well as balance cell charging/discharging rates
- 10 years' warranty

3.2.Interface Introduction

- This section details the interface functions of front and back panel..
- Front interface:

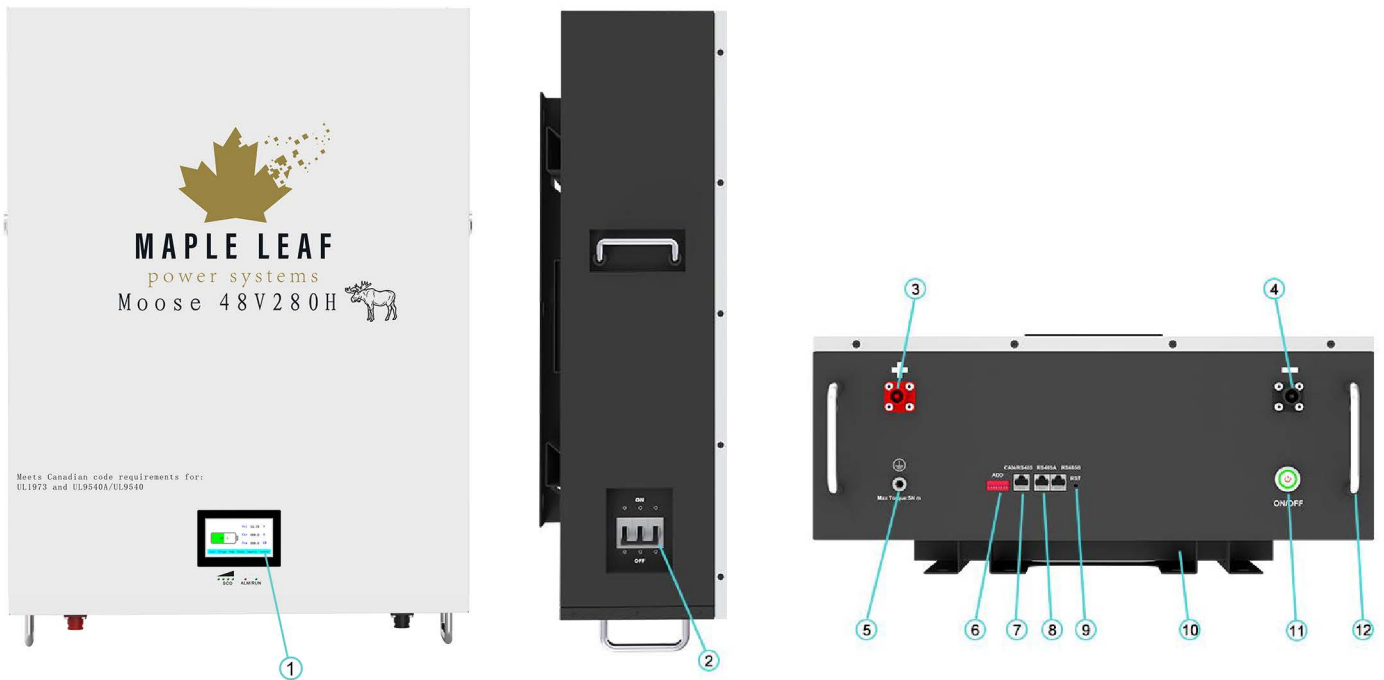

No	Description	Silk-screen	Remark
1	LCD SCREEN		
2	DC breaker	ON/OFF	
3	Power Positive Port	+	Output terminal
4	Power Negative Port	-	Output terminal
5	Ground Connect		
6	DIP address	ADS	Set the address for master battery and slave battery
7	CAN/485 port	CAN/485	CAN/485 port for all hybrid solar inverters communication
8	RS485A/B port	RS485A/B	RS485A/B port for batteries parallel communication and BMS software
9	Reset button	RST	For reset the batter
10	Battery holder-wallmounted		
11	Switch	OFF/ON	Normal close
12	Battery holder		

3.3.SOC Indicator & Status Indicator Guides

Chart 1: Battery Status







					
SOC				ALARM	RUN

Chart 2: Battery Capacity





















Capacity LED Indicator		 L4	 L3	 L2	 L1	 L4	 L3	 L2	 L1
SOC	0~25%	OFF	OFF	OFF	Flash	OFF	OFF	OFF	Flash
	25~50%	OFF	OFF	Flash	ON	OFF	OFF	Flash	Flash
	50~75%	OFF	Flash	ON	ON	OFF	Flash	Flash	Flash
	75~100%	Flash	ON	ON	ON	Flash	Flash	Flash	Flash
RUN Status 		ON				ON			

Chart 3: Battery status

Status	Normal	RUN	ALM	Capacity LED				Description
	Warning							
	Protection							
Shut Down	Shut Down	OFF	OFF	OFF	OFF	OFF	OFF	All OFF
Standby	Normal	Flash	OFF	OFF	OFF	OFF	OFF	Standby
Change	Normal	ON	OFF	Change				
	Warning	ON	Flash					
	Protection	ON	ON					
Discharge	Normal	ON	OFF	Change				
	Warning	ON	Flash					
	Protection	OFF	ON	OFF	OFF	OFF	OFF	UVP,OCP...
Fault		OFF	ON	OFF	OFF	OFF	OFF	Stop Charging or Discharging

3.4.Connectors

Charge / Discharge connectors: to connect the positive pole (+) and negative pole (-) from the battery to the inverter via DC isolator.

Canbus/485 active communication port between battery and inverter.

USB to RS485: to get dynamic monitoring data of the battery from upper computer.

Address: Reserved Address portal for multiple parallel connections.

3.5.Wake Up button

- Battery On: When battery is shut down, press this RST button for 6 seconds. It is activated when the LED lights flicker from RUN light to the lowest capacity indicator.
- Battery off: When battery is activated, press this button for 6 seconds. It will be shut down when the LED lights flicker from lowest capacity indicator to RUN light.
-



3.6.Display function instruction

3.6.1.Screen Display



3.6.2.Functional Specifications

- Interface introduction
- Main menu page
- Electricity/dormancy activated, will show the welcome screen, press the MENU button to enter the main menu page. As shown in the figure below:

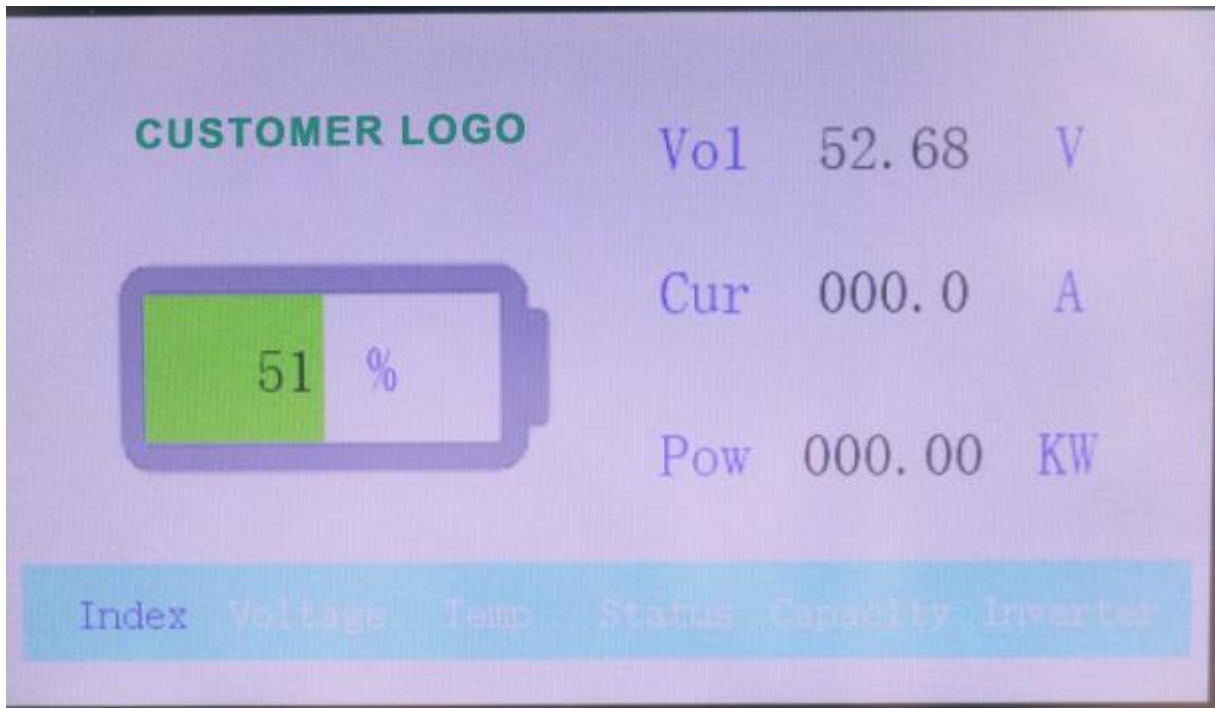

● Battery cells state



Voltage (mV)		Max	3296	Min	3291		
No01	3293	No02	3292	No03	3295	No04	3294
No05	3292	No06	3295	No07	3291	No08	3291
No09	3293	No10	3293	No11	3291	No12	3296
No13	3294	No14	3294	No15	3293	No16	3291

Index	Voltage	Temp	Status	Capacity	Inverter
-------	---------	------	--------	----------	----------

●Battery temperature

●

Temperature (°C)

T-01	22.7	°C	T-02	22.6	°C
T-03	22.5	°C	T-04	22.8	°C
T-MOS	25.4	°C	T-Env	25.8	°C

Index Voltage Temp Status Capacity Inverter

●Battery Warning

●

Status

OVP	N	UVP	N	OTP	N	UTP	N
OCC	N	OCD	N	SCD	N		

Index Voltage Temp Status Capacity Inverter

- **Battery Capacity**

Capacity

Remain_cap	139.7	Ah	Cycle	000	/
Full_cap	280.0	Ah	SOC	50	%
Desig_cap	280.0	Ah			

Index Voltage Temp Status Capacity Inverter

- **Protocols for different inverter brands**

Interver

485	PylonV3.5	Read
CAN	PL_Deye_TP	Write

Index Voltage Temp Status Capacity Inverter

● Dormancy/shutdown

Under normal operation condition, with no keystrokes 1 minute later, system will enter a state of dormancy/shutdown.

Shut down/dormancy state, press any key, screen can be activated.

4.Safe handling guide

4.1.System Diagram

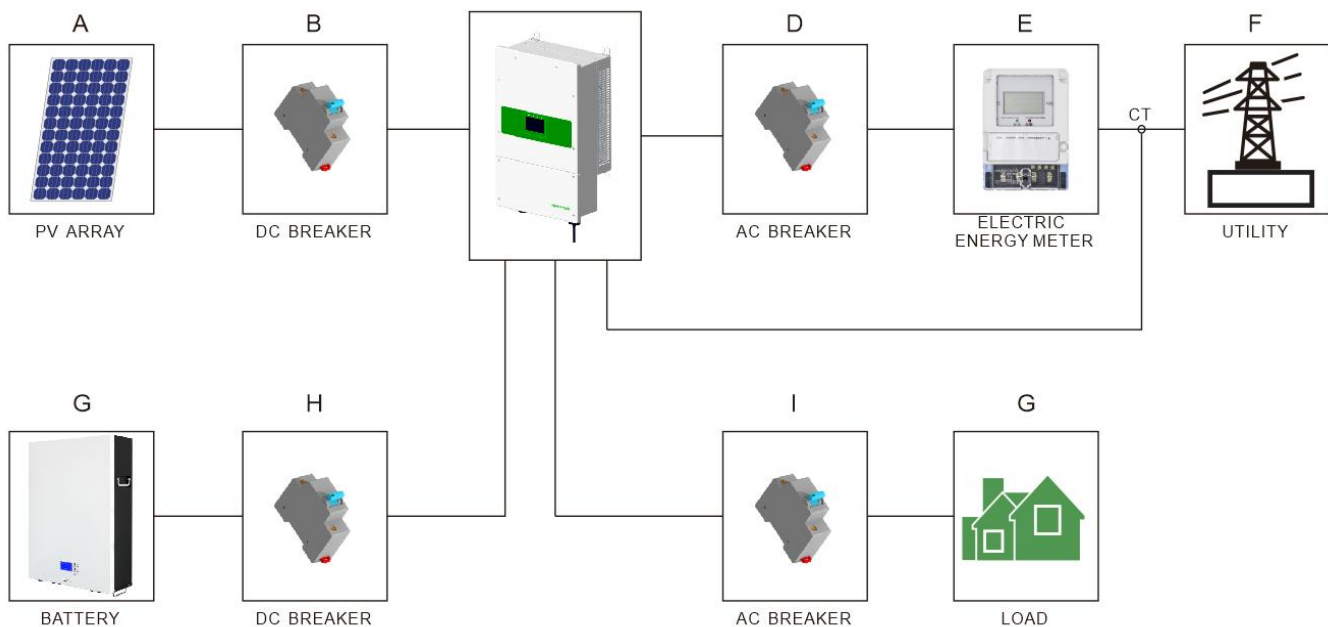

4.2.Tools

The following tools are required to install the battery pack:

- Wire cutter
- Crimping Modular Plier
- Screw Driver

NOTE

- Use properly insulated tools to prevent accidental electric shock or short circuits.
- If insulated tools are not available, cover the entire exposed metal surfaces of the available tools, except their tips, with electrical tape.

4.3.Safety Gear



It is recommended to wear the following safety gear when dealing with the battery pack:



- Insulated gloves
- Safety goggles
- Safety shoes

5.Installation

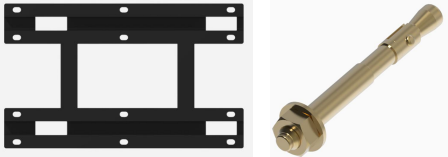
5.1.Inventory of items

Thoroughly inspect the packaging upon receipt of goods. If there is any item missing or if there is any damage to the external packaging or to the unit itself upon unpacking, please contact us immediately.

NO.	Item	Quantity	Specification
1	Battery Pack 	1 PC	5.12kwh, or 10.24kwh
2	Wall mounted Bracket and Screws 	1 SET	One Bracket and 12pcs screws.
3	Power Cable 	1 SET	35mm ² (4AWG) Black , Red L 2.0 meter
4	Canbus Cable	1 PC	Battery canbus port to Inverter Canbus port L : 1.5 meter

			
5	Parallel com cable 	1 PC	Battery com port to Battery com port for parallel 16pcs at max L: 1.0 meter

5.2.Installation Location

Make sure that the installation location meets the following conditions:

- The installation site must be suitable for the size and weight of the battery.
- Must be installed on a firm surface to sustain the weight of battery.
- The area is water proof.
- There are no flammable or explosive materials in proximity
- The ambient temperature is within the range from 0°C to 45°C.
- The temperature and humidity is maintained at a constant level.
- There is minimal dust and dirt in the area.
- Installation must be vertical or tilted backwards by maximum 15° - avoid forward or sideways stilt.

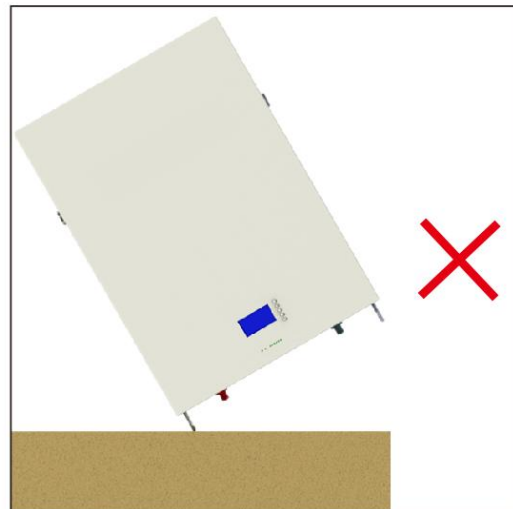
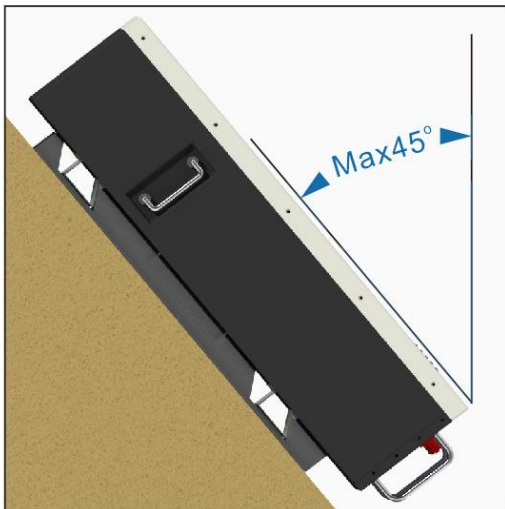

⚠ CAUTION

If the ambient temperature is outside the operating range, the battery pack stops operating to protect itself. The optimal temperature range for the battery pack to operate is 0°C to 45°C. Frequent exposure to harsh temperatures may deteriorate the performance and life of the battery pack.

5.2.1. Minimum clearances

Observe the minimum clearances to walls, other batteries or objects as shown in the diagram and picture below in order to guarantee sufficient heat dissipation

Direction	Minimum clearance (mm)
Above	300
Below	300
Sides	500
Front	300

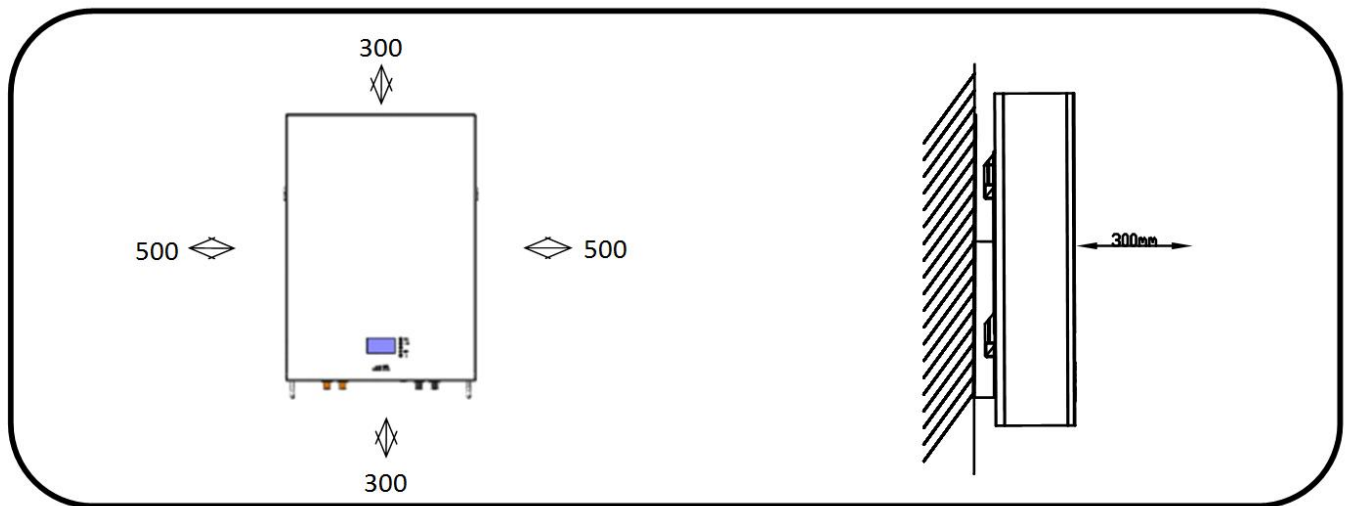

5.3. Installing the Battery Pack

5.3.1. Mounting to a wall

⚠ WARNING

In order to avoid electrical shock or other injury, inspect existing electronic or plumbing installations before drilling holes.

The battery is heavy, please handle with care to avoid damage to the product or injury to the installer.

1. Choose suitable firm wall with thickness greater than 80mm.
2. Use the mounting frame as a template, mark the hole position.

3. Drill 8 holes according to the hole position, it is $\varnothing 10$ with depth 60mm.

4. Hammer the M8 screws to the above holes, and screw the nut. Note: Do not position screws flush to the wall - leave 10 to 20 mm exposed.

5. Fix the mounting frame to the 8 screws.

6. Raise the battery a little higher than the mounting frame whilst maintaining the balance of the battery. Hang the battery on the frame through the match hooks.

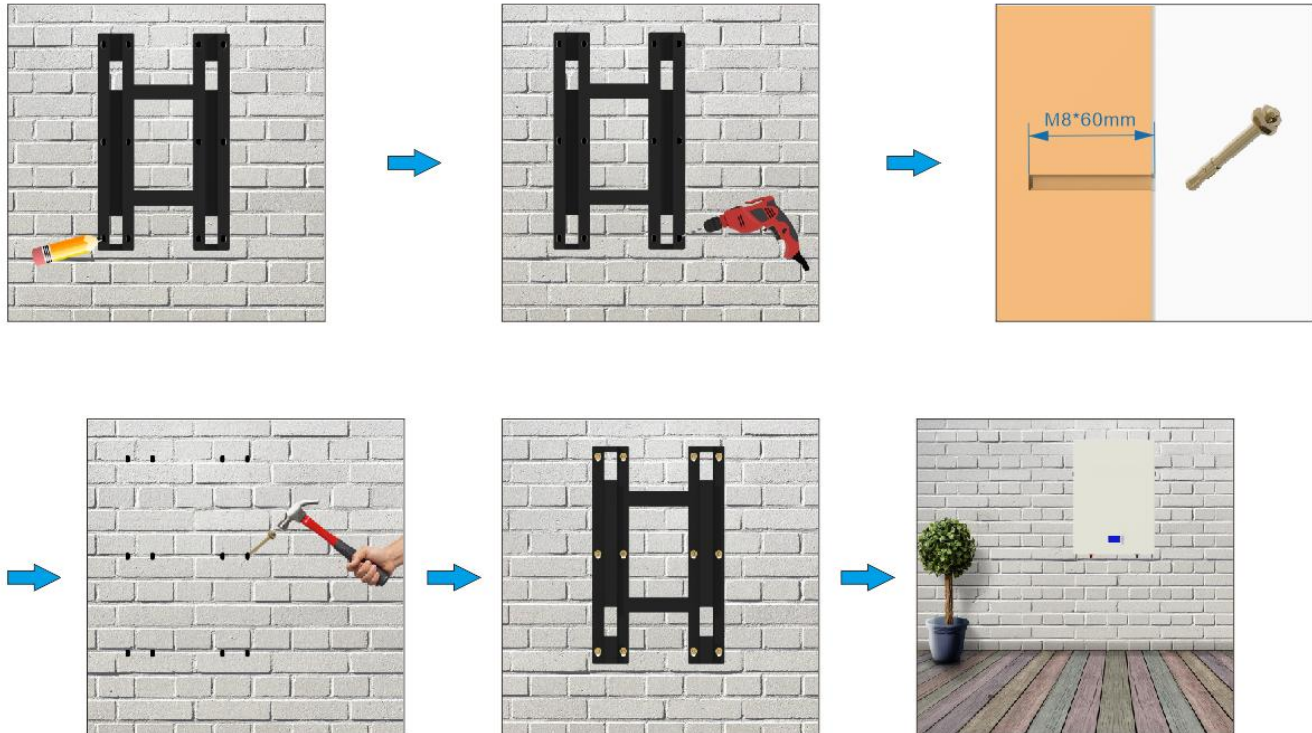

WARNING

Falling equipment can cause serious or even fatal injury: never mount the inverter on the bracket unless you are sure that the mounting frame is firmly mounted on the wall after thorough checking.

5.4 Parallel use of battery

5.4.1 Parallel use of battery (All off grid solar inverters)

GSL 48vdc lifepo4 battery is a smart battery to match all off grid solar inverter (48VDC) types. When the battery needs to be used in parallel, the maximum connection is **16 units**, but we recommend 2-4 units according to application. **When connecting with off grid 48VDC solar inverters, it does not need to add Canbus/RS485 communication cables with inverters, if inverter brand factory does not have Canbus/RS485 port, just plug and play use.**

One pcs connect diagram

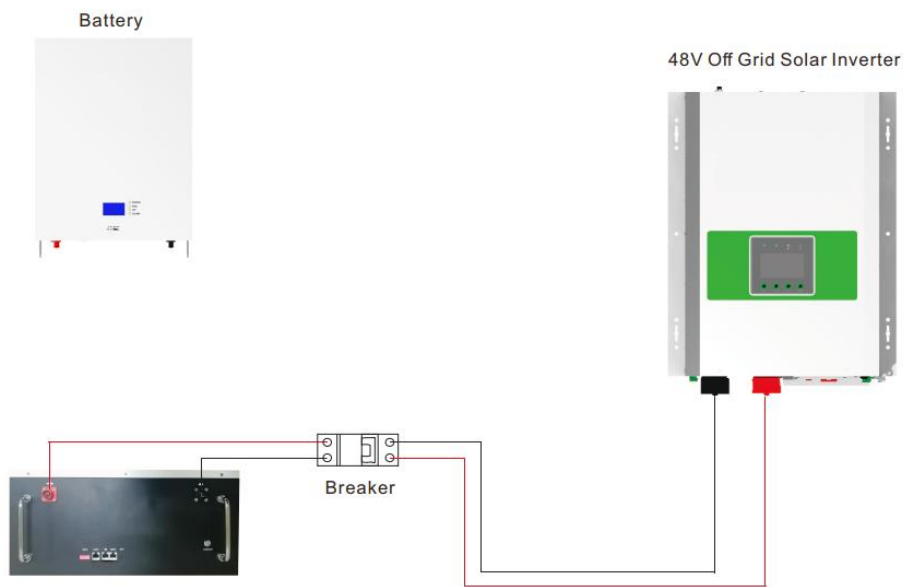

Two pcs connect diagram

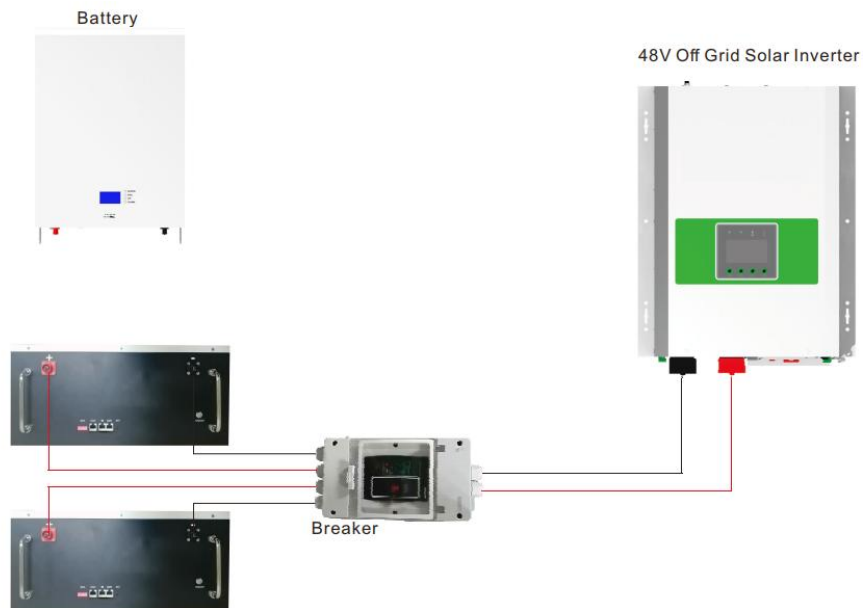

Three pcs connect diagram

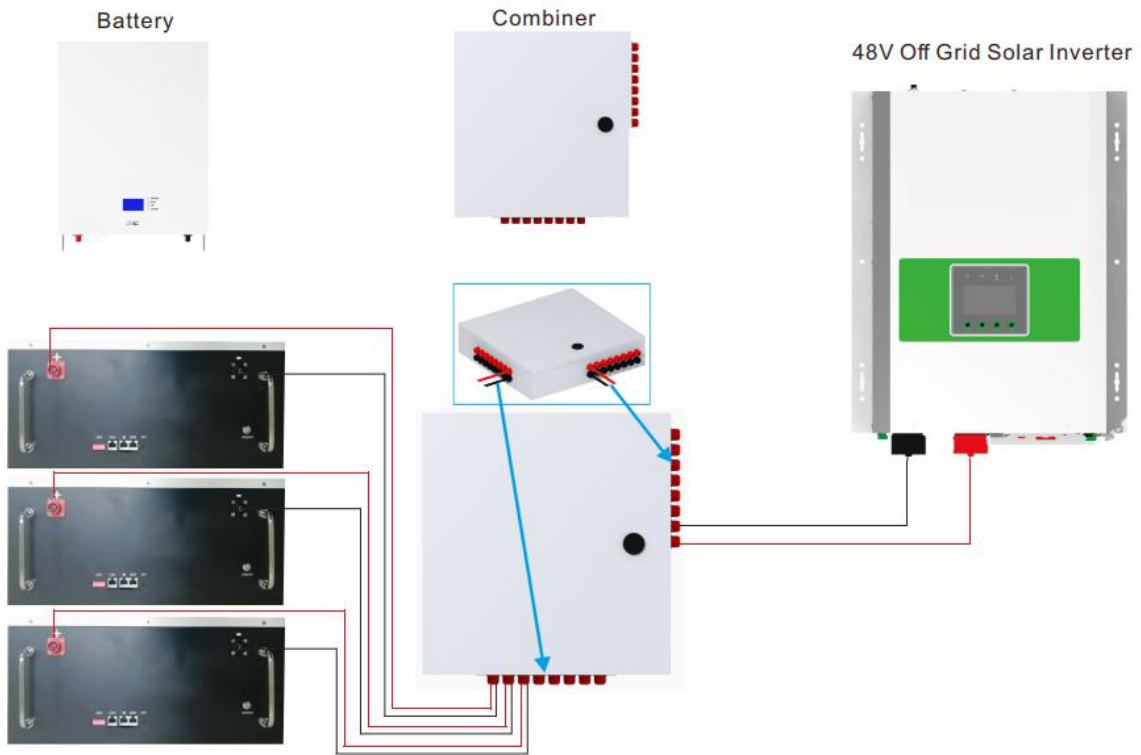

Four pcs connect diagram

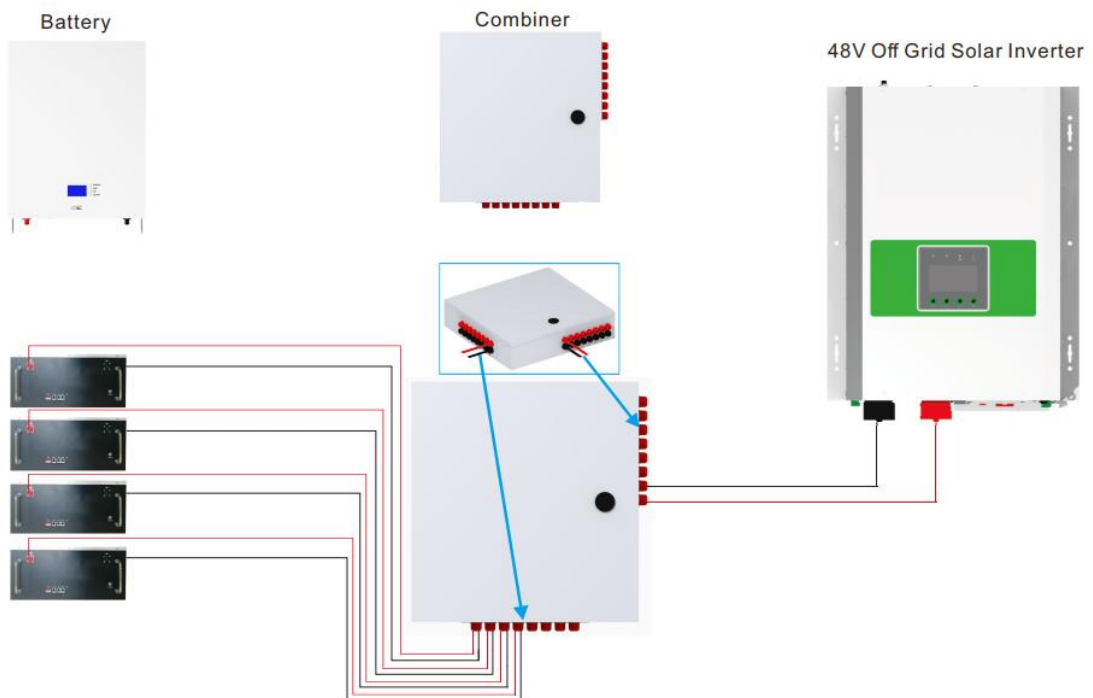

NOTE : IF YOU NEED MORE PARALLEL DETAILS, PLEASE CONSULT WITH ENERGTECH SOLAR SALES ASAP.

5.4.2 Parallel use of lifepo4 battery on Canbus

(hybrid on-off grid solar inverters)

When the battery needs to be used in parallel, the maximum connection is **16 units (Canbus) with hybrid solar inverter**, but we recommend to use 2-4 units according to application. The application needs power and communication connections as below, choose suitable parallel power cables and related connectors.

ADS guide Line

If you start to connect hybrid inverter, make sure you should consult with related inverter brand sales manager before connection.



One pcs connect diagram

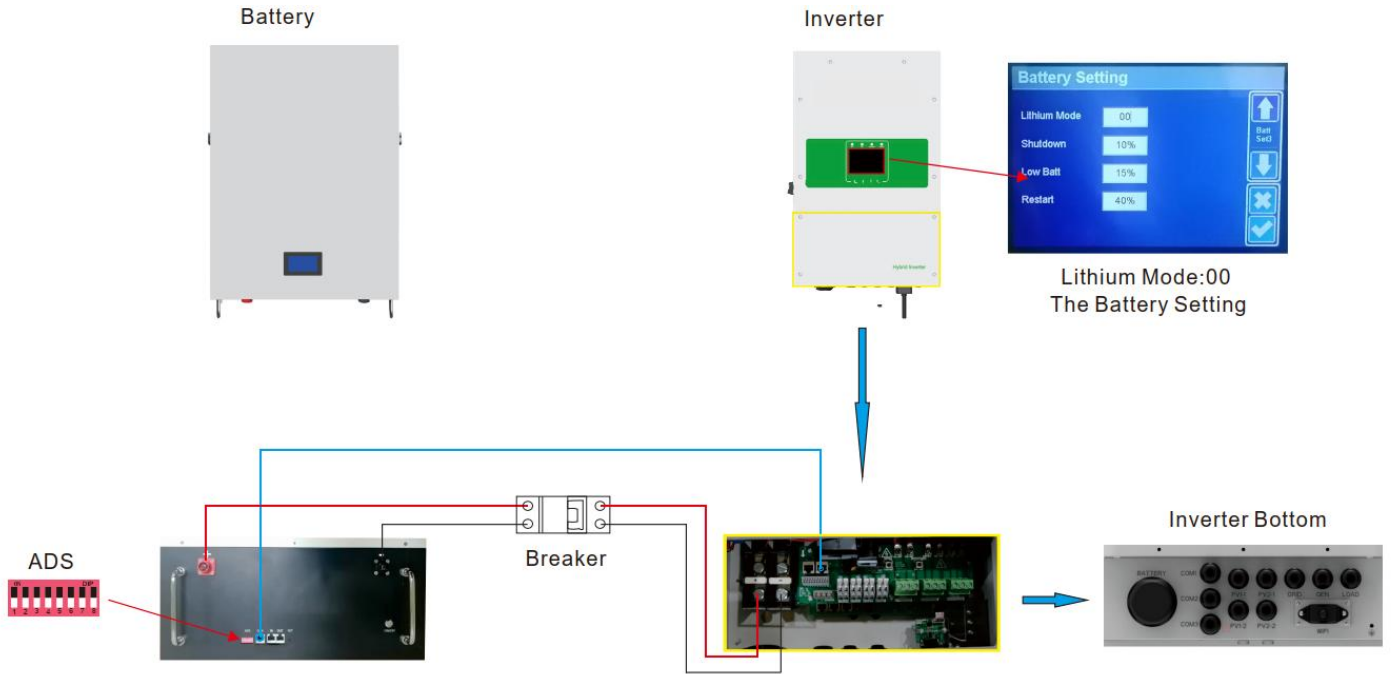

Two pcs connect diagram

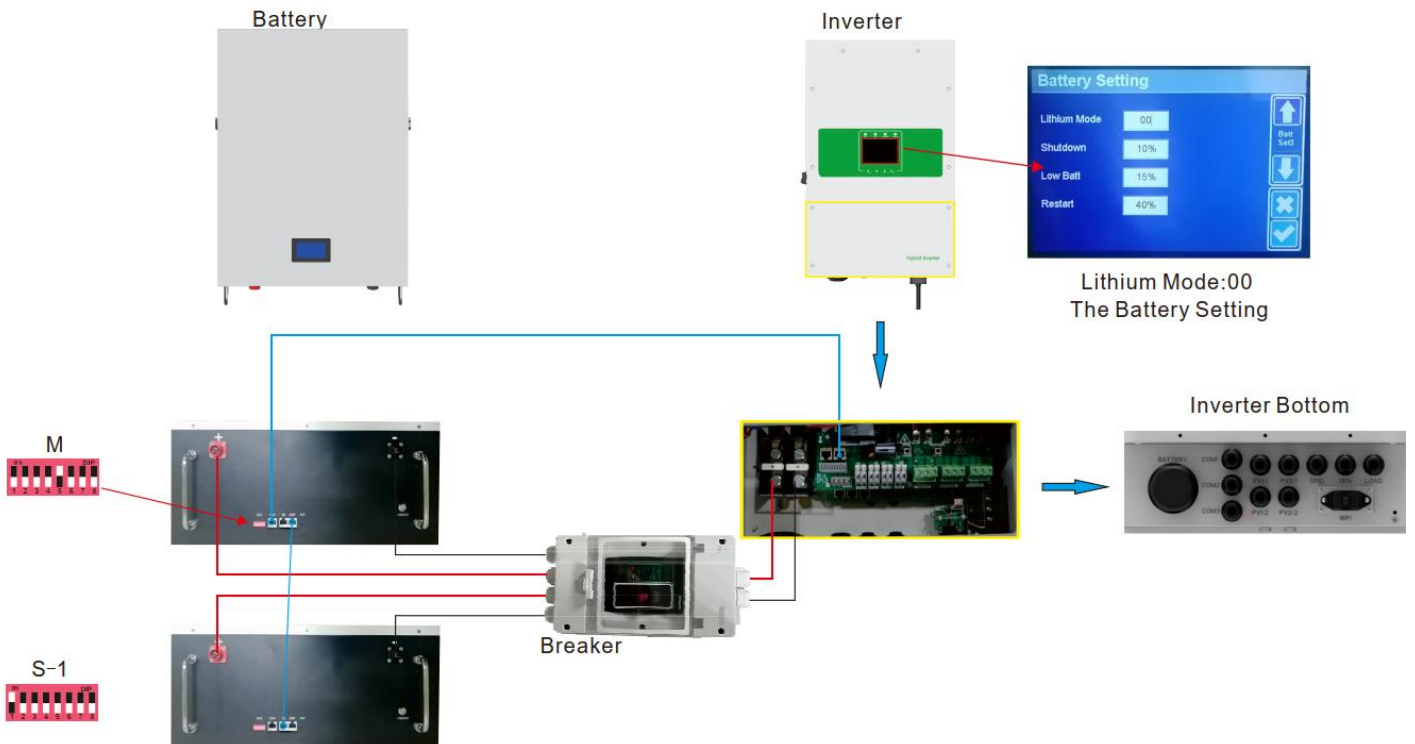

Three pcs connect diagram

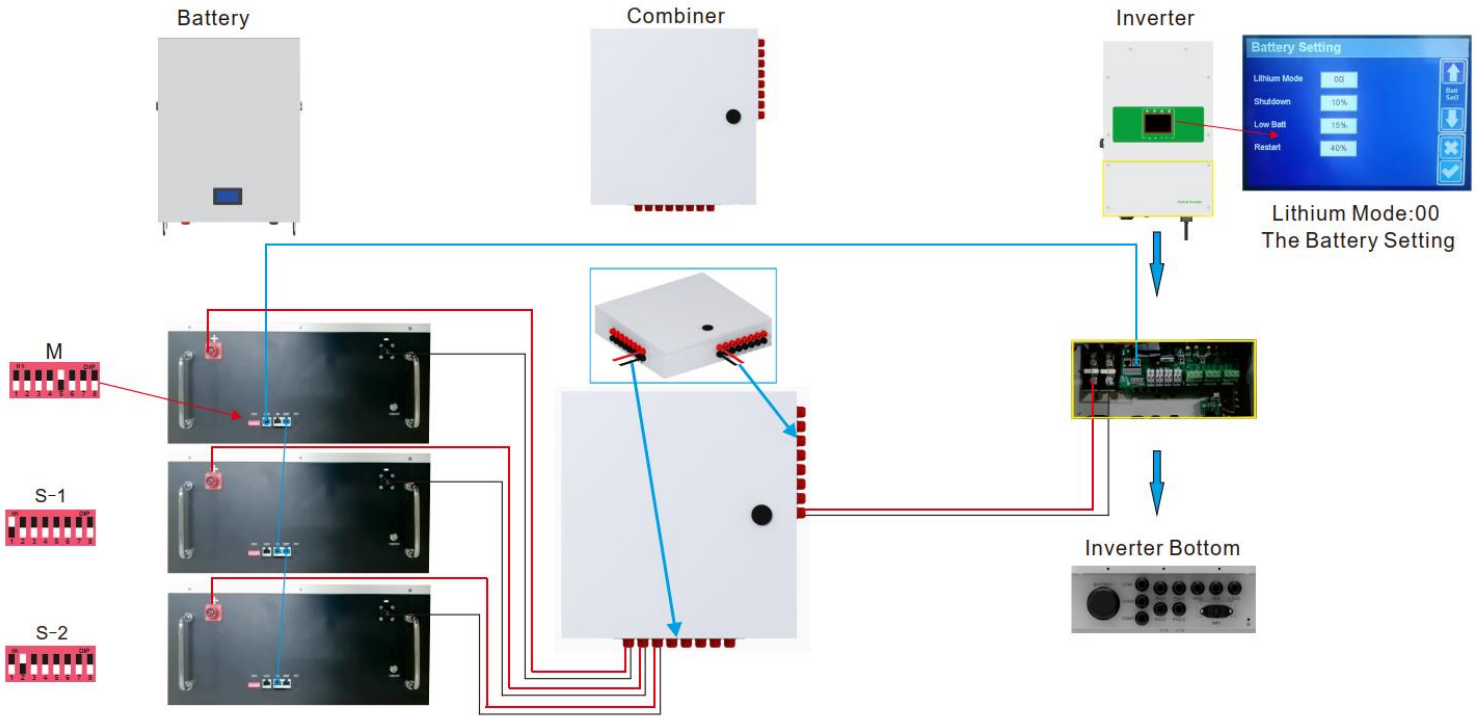

Four pcs connect diagram

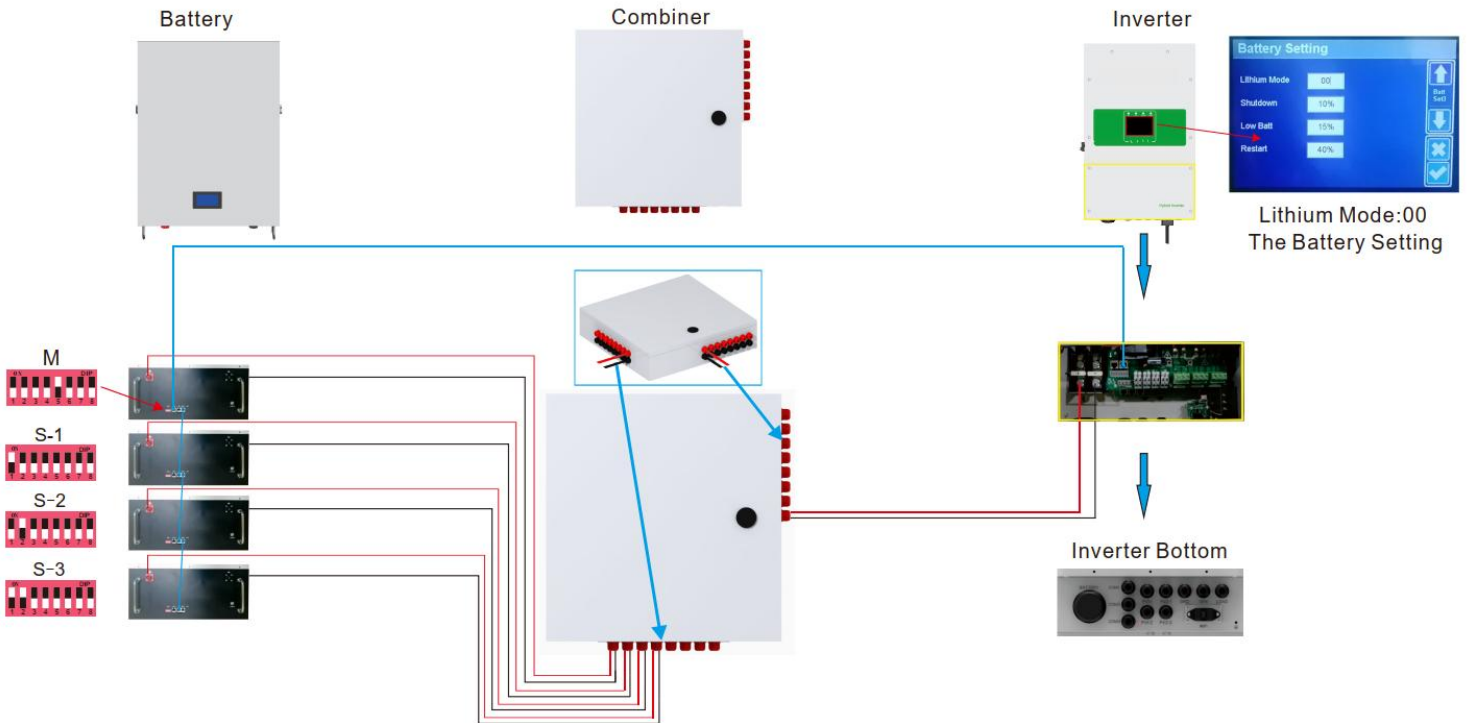

NOTE : IF YOU NEED MORE PARALLEL DETAILS, PLEASE CONSULT WITH RELATED SALES MANAGER ASAP.

6.Product Warranty

- 6.1.** If you have purchased this product from our factory, you should be aware that this warranty is provided in addition to other rights and remedies held by a consumer at law.
- 6.2.** You are entitled to a replacement or refund for a major failure and for compensation for any other reasonably foreseeable loss or damage. You are also entitled to have the goods repaired or replaced if the goods fail to be of acceptable quality and the failure does not amount to a major failure.
- 6.3.** For the above mentioned products, you receive our factory warranty valid for 10 years from the date of delivery from factory. Factory warranty covers any costs for repair or spare parts during the agreed period beginning on the date of delivery of the device, subject to the following conditions.

6.4. Factory Warranty Scope

The factory warranty does not cover damages caused by following reasons:

- Breaking the product seal (opening the casing)**
- Transport damage**
- Incorrect installation or commissioning**
- Failure to observe the user manual, quick installation instructions**
- Incorrect usage or inappropriate operation**
- Insufficient ventilation of the device**
- Failure to observe the applicable safety regulations**
- Force majeure**

Neither does it cover cosmetic defects which do not influence the energy production.

6.5. Warranty conditions

If the battery becomes defective during the agreed factory warranty period and, unless this should be impossible or disproportionate, one of the following options will be selected at the discretion of factory:

- Battery repair or**
- Battery repair at on-site, or**
- Exchange for a replacement device of equivalent value with regard to model and age.**

In the latter case, the remainder of the warranty entitlement will be transferred to the replacement device and your entitlement will be documented at factory.

Excessiveness in the meaning above exists in particular if the cost the measures for factor will be unreasonable.

- In view of the value that the device would have without the defect
- Taking in account of the significance of the defect, and
- After consideration of alternative work around possibilities at factory customers could revert to without significant inconvenience.

Please fill the required information in and send this page to factory when you need to apply warranty service support

Warranty Card

User Information

Company / User Name:

Address:

Telephone:

Email:

Project installation location:

Product Information

Battery Model:

Serial No :

Invoice Number :

Purchase Date :

Dealer :

Commission date :

Fault/Error Description: