

# **Rechargeable Lithium battery**

## **Operation and Maintenance manual**

Version: V-02

---

## Legal Provisions

---

This manual describes in detail the requirements and procedures for safe installation and operation of Maple Leaf lithium rack battery. Please read this manual carefully, only qualified persons are allowed to install, operate and maintain the system, otherwise it may cause product damage or personal safety risks.

Any actions against safety operation, or do not follow rules of this manual and limited warranty letter, will void warranty and qualification of this product. Meanwhile, the manufacturer will be not responsible for the product damage, property damage, personal injury or even death.

The information contained in this manual is accurate when it's issued. Maple Leaf reserve right to change specification (such as optimization, upgrade or other operations) without prior notice, please always view the latest document via QR code. In addition, please noted that the diagrams/schematics in this document are used to help understand system configuration and installation instructions, which may be different from the actual items at the installation.

Manual QR code



Register QR code



### Legal Terms

Maple Leaf will retain the copyright of this document, do not extract, copy or translate in any ways without the written permission.

---

## Version record

---

Version	Issued date	Updated content	Author
V00		Draft version	RS
V01		Released version	RS
V02		Explain the DIP setting in detail	RS

# Content

<b>1. Information</b> .....	6
1.1 Validity.....	6
1.2 Target Group.....	6
1.3 Levels of warning messages.....	6
1.4 Symbol Description.....	7
1.5 Abbreviation Description.....	8
<b>2. Safety</b> .....	10
2.1 Safety precautions.....	10
2.2 Safety instructions.....	10
2.2.1 Safety gear.....	11
2.2.2 Emergency safety measures.....	11
2.2.3 Other Tips.....	11
<b>3. Product Overview</b> .....	13
3.1 Introduction.....	13
3.2 Features.....	13
3.3 Specification.....	15
3.3.1 Dimension.....	15
3.3.2 Parameters.....	15
3.3.3 Panel Interface.....	16
3.4 Protection function.....	19
<b>4 Installation</b> .....	21
4.1 Preparation.....	21
4.1.1 Safety Compliance.....	21
4.1.2 Environment.....	21
4.1.3 Tools.....	21
4.2 Inspection.....	22
4.2.1 Unpacking.....	22
4.2.2 Scope of delivery.....	22
4.2.3 External cable kits.....	26
4.2.4 Battery registration.....	27
4.3 Start Installation.....	27
4.3.1 Remainder.....	28
4.3.2 Procedures.....	28
4.3.3 Tips.....	31
<b>5. Cable connection and commissioning</b> .....	33
5.1 Get battery ready.....	33
5.2 Grounding cable connection.....	33
5.3 Communication cable connection.....	34
5.4 DC power cable connection.....	34
5.5 Connecting with inverter.....	35
5.6 Commissioning.....	39
5.7 Switch off battery.....	39
<b>6. Transport, Storage</b> .....	42

---

<b>7. Disposal of battery</b> .....	43
<b>Appendix I</b> .....	44

---

# 1. Information

## 1.1 Validity

This document is valid for: Beaver 48V and Beaver 48VH Battery Pack.

## 1.2 Target Group

This document is intended for qualified persons and operators. Only qualified persons are allowed to perform the activities marked in this document with a warning symbol and the caption "Qualified person".

Qualified persons must have the following skills:

- Knowledge of how lithium iron phosphate batteries work and are operated.
- Knowledge of how an energy storage system (including PV/battery/hybrid inverter, MPPT, Meter, Distribution box etc.) works and is operated.
- Knowledge of local applicable connection requirements, standards, and directives.
- Training in the installation and commissioning of electrical devices, batteries.
- Training in how to deal with the dangers and risks associated with installing, repairing and using electrical devices, batteries.

## 1.3 Levels of warning messages

The following levels of warning messages may occur when handling the product

### DANGER

Indicates a hazardous situation which, if not avoided, will result in death or serious injury.

### WARNING

Indicates a hazardous situation which, if not avoided, could result in death or serious injury.

### CAUTION









Indicates a hazardous situation which, if not avoided, could result in minor or moderate injury or product permanent damage.

## ⚠ NOTICE

Indicates a situation which, if not avoided, can result in property damage or product not work or accelerated product damage



### 1.4 Symbol Description

#### 1.4.1 Symbols on products label

Label	Definition
	Beware of electrical shock
	Do not place the battery within children/pet touchable area.
	Do not place the battery near heat source and flammable material
	Do not expose the battery to direct sunlight, rain and snow.
	Do not short circuit the battery
	The certificate label for Safety by TÜV Rheinland
	The UL1973 certificate label for Safety by Intertek
	The certificate label for European EMC directives
	The certificate label for U.K EMC directives

	Recycle label
	WEEE designation

#### 1.4.1 Other symbols

Label	Definition
	Indicates activities that can only be performed by qualified persons
	Grounding point

### 1.5 Abbreviation Description

Abbreviation	Definition
Battery/battery pack/battery module	Single rechargeable lithium iron phosphate battery battery pack including cells, BMS and enclosure etc.
Battery system/cluster	Multiple battery packs connected in parallel with power, communication and grounding cables and installation auxiliaries.
BMS	Battery management system Electronical Unit to ensure lithium cells' safety and display information or control the battery work mode.
SOC	State of charge The battery state of charge refers to the percentage of the remaining capacity and rated capacity of the battery.
SOH	State of health The battery health status refers to the percentage between the full charged capacity and the rated capacity of the battery.
DIP switch	Dual in-line package switch
COCP	Charge over current protection
DOCP	Discharge over current protection
COVP	Cell over voltage protection
POVP	Pack over voltage protection
CHTP	Charge high temperature protection
DHTP	Discharge high temperature protection
CUVP	Cell under voltage protection
PUVP	Pack under voltage protection



---

CLTP	Charge high temperature protection
DLTP	Discharge high temperature protection
SCP	Short circuit protection

---

## 2. Safety

### 2.1 Safety precautions

#### DANGER

##### Explosion risk

- Do not impact the battery with heavy objects.
- Do not squeeze or pierce the battery pack.
- Do not throw the battery pack into the fire.

#### WARNING

##### Fire risk

- Do not expose the battery pack to the condition over 80°C.
- Do not put the battery near a heat source, such as a fireplace.
- Do not expose the battery pack to direct sunlight or raining.

#### CAUTION

##### Electric shock risk

- Do not allow non-qualified person to disassemble the battery pack.
- Do not touch the battery pack with wet hands.
- Do not expose the battery pack to moisture or liquid environment.

#### NOTICE

##### Damage risk

- Do not short-circuit or reverse connect the battery.
- Do not use chargers or charging devices unapproved by the manufacturer to charge the battery.
- Do not mix batteries from different manufacturers or different kinds, types or brands.

### 2.2 Safety instructions

The battery has been designed and tested in accordance with international (such as UL, IEC, UN38.3 etc.)

---

safety requirements. However, due to various factors during the whole lifetime process, MapleLeaf cannot guarantee absolute safety, in order to prevent personal injury and property damage and ensure long-term operation of the battery, please do read the below section carefully to operate the battery and handle emergency situations.

### 2.2.1 Safety gear

It is required to wear the following safety gear when installing and handling the battery pack.



Insulated gloves



Safety Glasses



Safety Shoes

### 2.2.2 Emergency safety measures

#### Water invasion

Please cut off the AC power supply of the system first and then disconnect all switched under the premise of ensuring safety.

#### Electrolyte or gas leakage

If the battery pack leaks electrolyte, avoid contact with the leaking liquid or gas. If one is exposed to the leaked substance, immediately perform the actions described below.

- **Gas Inhalation:** Evacuate the people in the contaminated area and seek medical aid immediately.
- **Eye Contact:** Flush your eye with clean and flowing water for 15 min, and seek medical aid immediately.
- **Skin Contact:** Thoroughly rinse the exposed area with soap and water to be sure no chemical or soap is left on them, and seek medical aid immediately.
- **Ingestion:** Induce vomiting, and seek medical help immediately.

#### WARNING

In case of fire situations, please use carbon dioxide fire extinguisher rather than liquid to put out fires.

### 2.2.3 Other Tips

- All the product are strictly inspected before shipment, please contact your supplier for replacement if you notice there's any defectives such as swelling.
- Do not disassemble batteries and components, otherwise the manufacturer will not be responsible for

---

any damage caused by unauthorized disassembly or repair.

- Do enable the battery to be safely grounded before use to make sure the system in safe and normal operation.
- Please ensure that the electric parameters of these devices are compatible mutually before connecting the battery to other devices.
- Please take the environmental factors into careful considerations to ensure that the system can work in a suitable condition as the environment and storage methods have a certain impact on the service life and reliability of this product.

## 3. Product Overview

### 3.1 Introduction

The 48V Beaver battery line is designed for residential application and works as a storage unit in the photovoltaic system. It is a 51.2V lithium battery system, with BMS inside. It could be operated in both on-grid, back-up and off-grid modes with compatible inverters. Below is the general schematic of an ac-coupled system with the batteries.

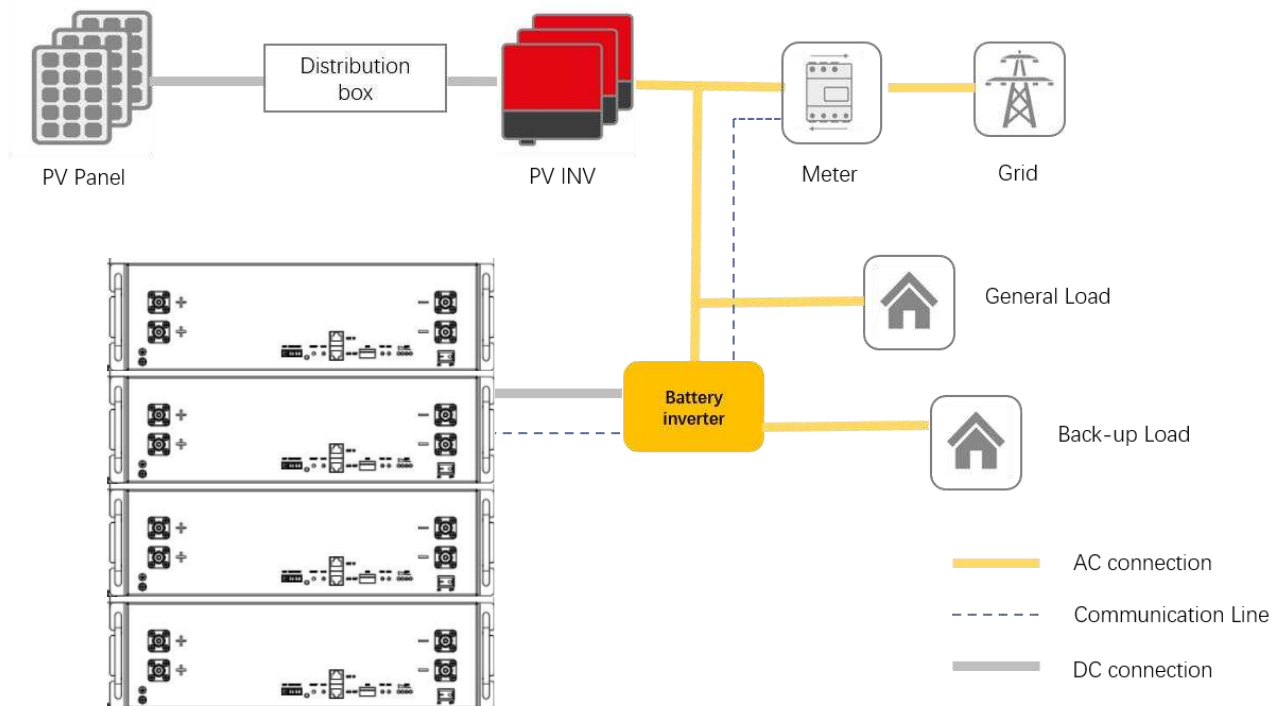

### ⚠ CAUTION

This electrical connection in this diagram is only for illustration, please follow the Manual suggestions of related devices and operate in accordance with locally applicable connection requirements, standards, and directives.

### 3.2 Features

- Highest safety, battery is made from LiFePO<sub>4</sub> chemistry and comply with highest international safety and transport standard.
- Modular and flexible, support up to 32 batteries connect together to expand the system energy.
- Built-in pre-charge circuit to avoid rush current when connecting with different inverter/chargers.
- Automatic dynamic addressing function when connected multiple batteries together.

- 
- Support a maximum of 96% DOD under off-grid and back-up application
  - Built in BMS provide warning and protection functions including over-discharged, over-charged, over-current, short-circuit and high/low temperature.
  - LiFePO<sub>4</sub> as cathode material and automatic balancing function to meet longer cycle life
  - Compact size and light weight for easy installation and maintenance.
  - Multiple installation bracket to adopt with different customers' requirement.
  - LED display, CAN/RS485 port for external communication and upgrade the BMS firmware.
  - Rapid shut down function for North American market.

## 3.3 Specification

### 3.3.1 Dimension

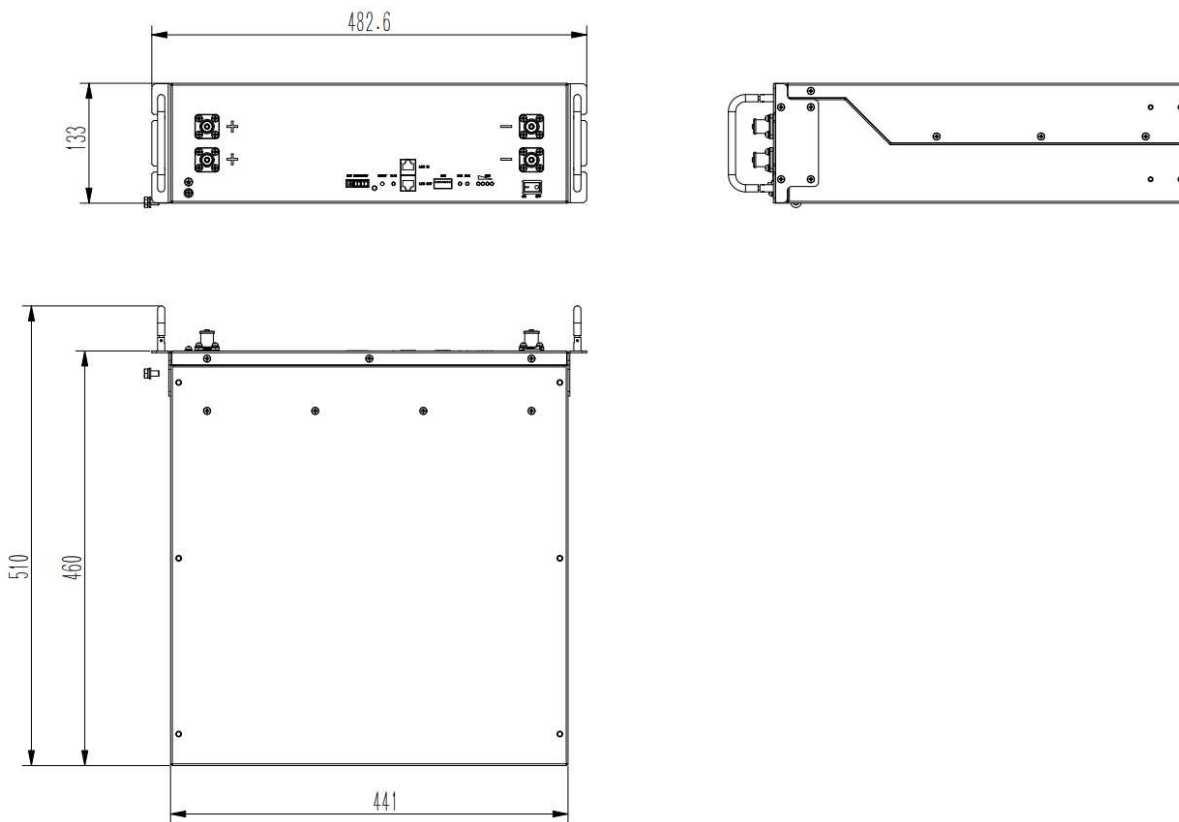

### 3.3.2 Parameters

Items	RS-R51100A
Rated voltage	51.2V
Max. voltage range	44.8~57.6V, Shipping voltage>51.2V
Charge voltage	56.0V
Float charge voltage	54.6V
Nominal energy@0.2C	5.12KWh
Usable energy@0.2C	4.92kWh
Nominal capacity@0.2C	100Ah
Dimension	482*133.5*460mm (18.9*5.2*18.1 inch)
Weight	~46kg (101lb)
Standard charge current	≤50A
Max. charge current	70A
Standard discharge current	≤50A
Max. discharge current	100A (initial temp. ≤30°C)
Peak discharge current	101~119A@5mins   120~200A@15S

Communication	RS485 /CAN	
Max parallel number	32pcs	
Operation temperature <sup>1</sup>	Charge: -5~50 °C Discharge: -10~50 °C Discharge: -20~50 °C (Beaver 48VH Model)	
Storage temperature @off mode	0 °C < T < 30 °C	< 6 months
	-10 °C < T < 45 °C	< 3 months
	Recommended environment	15~35 °C , 5~75%RH

## ⚠ NOTICE

The optimum operating temperature range is from 15°C to 30°C, Frequent exposure to the harsh temperatures may worsen the performance of the battery pack and cycle life.

### 3.3.3 Panel Interface

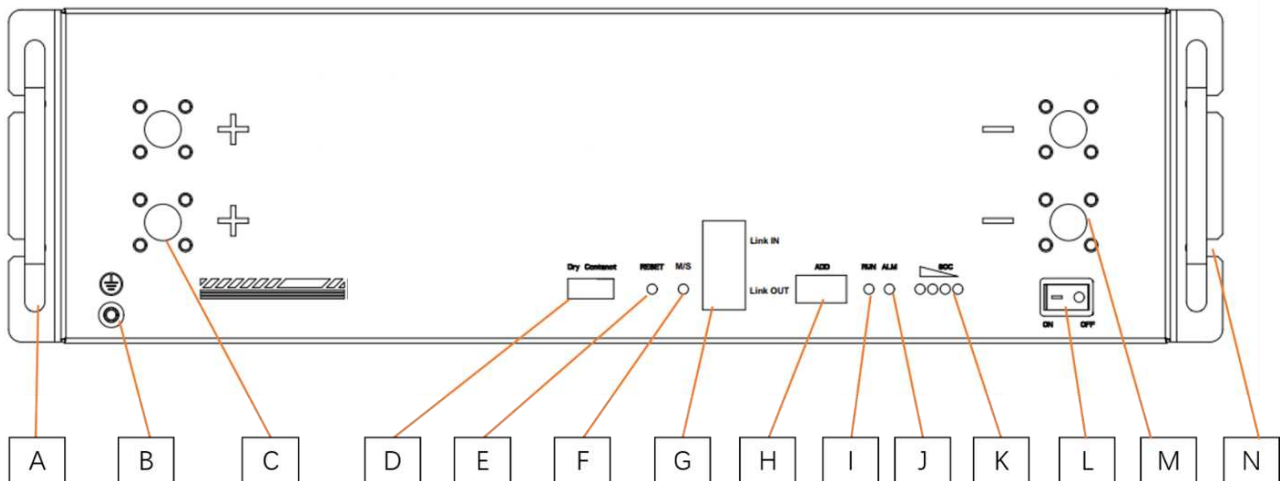

No.	Items	Usage description	Remark
A	Handles	For handling, intallation and disassembly of battery	
B	Grounding	Used to connect battery with ground	
C	Positive terminal	Used to connect the inverter/charger	
D	Dry contact	1 channel input signal 2 channels output signal	
E	Reset	Used to sleep(3s)/awake(3s)/reset(6~10s) BMS in power on mode.	
F	M/S	Used to indicate the module is Master or Slave battery	<b>Single mode:OFF</b>



			<b>Parallel mode:</b> ON- Master battery OFF-Slave battery
G	Link IN Link OUT	For internal and external communication	
H	DIP	Used to set the RS485 baud rate and inverter protocol choosing	
I	RUN	Used to show battery is in running status when lighting or flashing	
J	ALM	Used to show battery Alarm/Protection status	
K	SOC	Used to show battery real-time SOC	
L	Power switch	Used to Power on/off battery	
M	Negative terminal	Used to connect the inverter/charger	
N	Mounting ear	Used to fix with rack or cabinet	

### 3.3.3.1 D: Dry contact

PIN	Type
1	NO Output1, Charge enable/disable signal
2	
3	NO Output2, discharge enable/disable signal
4	
5	Passive <b>INPUT</b> signal. Rapid Shut Down function for US
6	

### 3.3.3.2 G: Link IN / Link OUT

Port	Pin No.	Definition	Remarks
Link IN	1	RS485-B1	1.Used to connect with external devices to establish communication. 2.Used to connect with upper battery pack Link OUT.
	2	RS485-A1	
	3	SGND	
	4	CAN-H	
	5	CAN-L	
	6	SGND	
	7	RS485-A1	
	8	RS485-B1	
Link OUT	1	RS485-B2	Used to connect with downward battery pack Link IN.
	2	RS485-A2	
	3	SGND	
	4	CAN-H	
	5	CAN-L	
	6	SGND	
	7	RS485-A2	



	8	RS485-B2	
--	---	----------	--

### 3.3.3.3: DIP addressing

DIP						Remarks	
RS485 baud rate	Undefined				Protocol		
1	2	3	4	5	6	7	
ON: 115200	Reserved for multiple cluster parallel and other future function				0	0	Protocol ID0
OFF: 9600					1	0	Protocol ID1
					0	1	Protocol ID2
					1	1	reserved
<b>Keep all batteries the same setting</b>	<b>Keep default setting</b>				<b>Master: according to inverter brand Slave: keep default setting</b>		

Note:

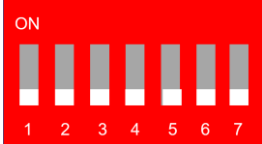
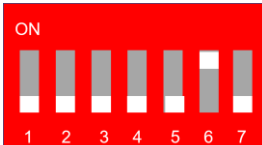
Only master battery needs to set the Protocol ID, keep all slave battery default setting, after choose the protocol ID, the battery will auto detect the inverter information and corresponding to get into running, restart to take effect after setting new DIP sequence.

Protocol ID	CANbus Connection	RS485 Connection	DIP setting (Master battery)
0	Victron/SMA/Studer Innotec/Sofar	MapleLeaf/RCT/MPP/Alpha outback/Phocos	 X000000
1	Sol-Ark/Solis/Goodwe/Deye/ Growatt/SAJ/LUXPOWER Megarevo/INVT/Sermatec/ TBB/MUST/Sunsynk		 X000010
2	Schneider		 X000001

## ⚠ NOTICE

Fail to follow the DIP switch setting will cause the communication fault between battery and inverter, for more detail setting with different inverter/charger, please contact your supplier for consultation.

### 3.3.3.4 RUN/ALM/SOC

Mode	Status	RUN	ALM	LED indicator				Description
		●	●	●	●	●	●	
Power off	-	OFF	OFF	OFF	OFF	OFF	OFF	All OFF
Standby	Normal	FLASH1	OFF	According to battery SOC				See note
	Warning	FLASH1	FLASH3					
Charge	Normal	ON	OFF	According to battery SOC (highest SOC LED: FLASH2)				See note
	Warning	ON	FLASH3					
	COCP	FLASH1	OFF	According to battery SOC				Stop charging
Discharge	Normal	FLASH3	OFF	According to battery SOC				See note
	Warning	FLASH3	FLASH3					
	CUVP/PUVP	OFF	FLASH3	OFF	OFF	OFF	OFF	Stop discharging
	DOCP	OFF	ON	OFF	OFF	OFF	OFF	Stop discharging
Temperature	CHTP/DHTP CLTP/DLTP	OFF	ON	OFF	OFF	OFF	OFF	Stop charging/dis charging
Failure	Cell/NTC failure Sensor failure MOS failure Reversed polarity /SCP	OFF	ON	OFF	OFF	OFF	OFF	Stop charging/dis charging

Note: 'Warning' including items of cell imbalanced/low voltage/high current/high&low temperature.

FLASH Type	ON	OFF
FLASH1	0.25S	3.75S
FLASH2	0.5S	0.5S
FLASH3	0.5S	1.5S

## 3.4 Protection function

Items	Description	Remark
Charge end COVP	The BMS will stop charging if any cell or PACK voltage reach the protection value and it will be auto-released only when both	

POVP	Pack and cell voltage back to the release voltage range or there is efficient discharge current.	
Discharge end CUVP PUVP	The BMS will stop discharging if any cell or PACK voltage is under the protection value and it will be released only when all the cell voltage back to the release voltage range or there is efficient charge current.	Can Automatic recovery. Please charge timely, otherwise it may be in Low-power mode to be over-discharged and damage battery.
CHTP DHTP	The BMS will stop charging or discharging or both if any cell/environment/MOS temperature is beyond the range.	Automatic recovery when temperature falls.
CLTP DLTP	The BMS will stop charging or discharging or both if any cell/environment/MOS temperature is under the range.	Automatic recovery when temperature rise.
COCP	The BMS will stop charging when the charging current is higher than the protection value. And it will release from the protection when the system delays time is met.	Automatic recovery. If locked after three consecutive times, manual intervention is required.
DOCP	The BMS will stop discharging when the discharging current is higher than the protection value. And it will release from the protection when the system delays time is met	Automatic recovery. If locked after three consecutive times, manual intervention is required.
SCP Reversed polarity	The BMS will stop charging when detect short circuit or reversed polarity.	Charge to release. Manual press reset.
Temperature, Voltage, Current sensor failure	Enter the failure mode, manual intervention is required no charging and discharging.	Manual intervention.
Sleep mode	After reaching a certain condition, BMS will enter dormancy mode to reduce BMS consumption	Charge, press reset or restart to activate.

### CAUTION

Please re-charge the battery via MPPT, grid/generator or other energy source within 24h if the battery is over discharged, otherwise, it may be damaged.

### NOTICE

Manually short-circuit and reverse the battery will void the warranty.

## 4 Installation

### 4.1 Preparation

#### 4.1.1 Safety Compliance



The system installation must be finished by qualified person(s), During the whole installation process, please strictly follow the local safety regulations and related operating procedures.



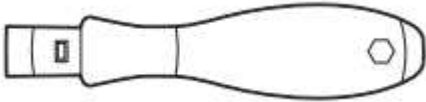

#### 4.1.2 Environment

The operating environment shall meet the following requirements:

Category	Description
Working temperature	-20°C - 50°C (with heat pad) and -10°C - 50°C(maximum operating range) 15°C-30°C (optimal temperature)
Relative humidity	5%~90%, No condensation
Altitude	<3000m
Safety requirement	<ul style="list-style-type: none"><li>• Do not expose the battery to direct sunlight, rain and snow.</li><li>• Do not place the battery within children/pet touchable area.</li><li>• Do not place the battery near heat source and flammable material</li><li>• Do not drop, deform, impact, cut or spearing with a sharp object.</li><li>• Do not put heavy things on battery.</li><li>• Do not disassemble the battery without Manufacturer's permission.</li><li>• No conductive dust and water or other liquid to contact battery.</li><li>• Follow the emergency measure if there is water invasion or electrolyte and gas leakage.</li><li>• Contact your supplier within 24 hours if any product failure happens.</li></ul>

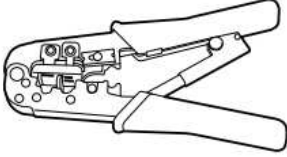
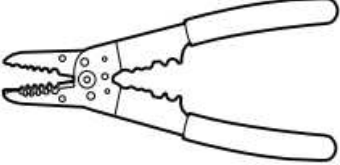
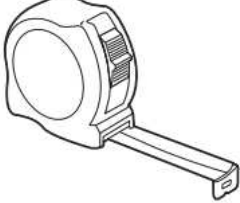
#### 4.1.3 Tools

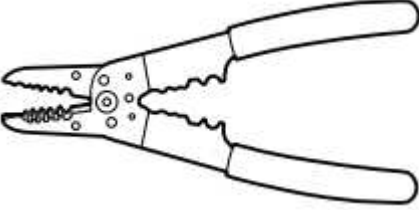
Tools	
Torque screwdriver 	Multi-meter 

<p>Torque wrench</p> 	<p>Cable crimper</p> 
<p>Wire stripper</p> 	<p>Tape measure</p> 
<p>Flat-head screwdriver</p> 	<p>Phillips-head screwdriver</p> 
<p>Wire stripper</p> 	<p>Drill</p> 
<p>Phillips-screwdriver bit</p>	<p>Hex-key bit</p>

## 4.2 Inspection





### 4.2.1 Unpacking

- Please load and unload it in accordance with the specified requirements to prevent sun and rain when you receive the equipment.
- Please check and confirm the goods (such as quantity, appearance, etc.) according to the "scope of delivery " before unpacking.
- Please unpack gently during unpacking process to protect the surface coating of the object;
- Please record and feedback to the manufacturer if the inner packing is damaged after unpacking.

### 4.2.2 Scope of delivery

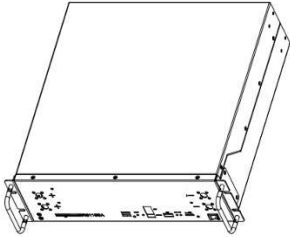
Check the scope of delivery for completeness and any externally visible damage. Contact your supplier

for supplementary delivery if the listed material is incomplete or damaged.

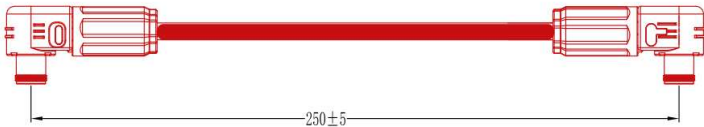
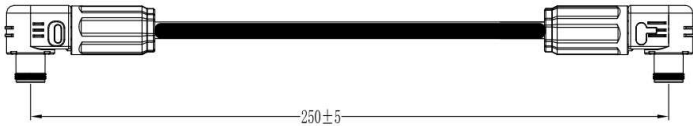
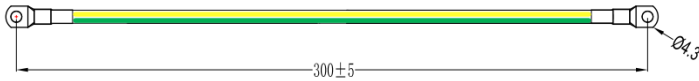
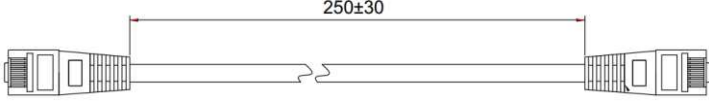
General materials		
<i>(Battery unit)</i>		
		
Battery Pack *1pcs	Manual *1pcs	Warranty document *1pcs
Optional materials [NOT INCLUDED IN THE PACKAGE]		
Mounted kits Type	Material detail	Qty.
<b>Rack mounted kits</b>  (Packing with general materials, with mark on the carton)	A: Float nuts M6  	6pcs
	B: Combination Screw	4pcs
	C: Battery to battery parallel positive cable(250mm)  	1pcs
	D: Battery to battery parallel negative cable(250mm)  	1pcs
	E: Battery to battery grounding cable(300mm)  	1pcs
	F: Battery to battery communication cable(250mm)  	1pcs

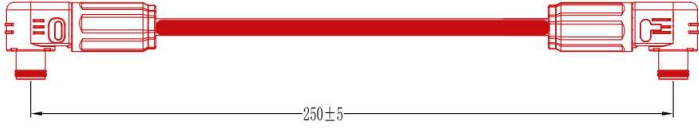
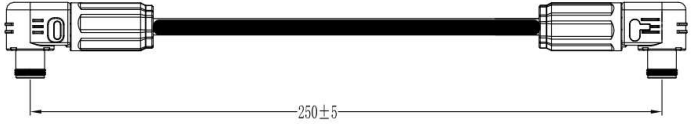
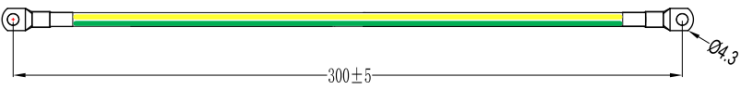
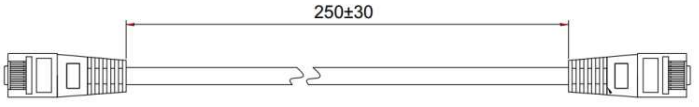
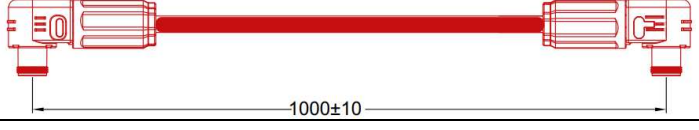
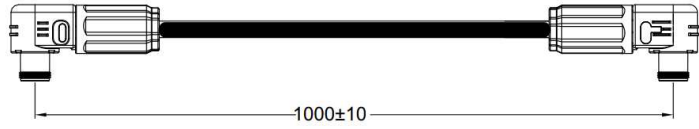
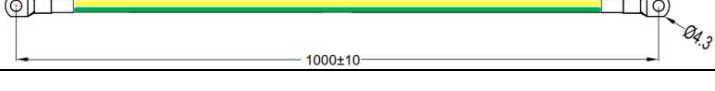
<b>Stack mounted kits</b> (Packing using separately carton)	A: Stacking components	4pcs
	B: Head screw M4	16pcs
	C: Battery to battery parallel positive cable(250mm)	1pcs
		
	D: Battery to battery parallel negative cable(250mm)	1pcs
		
E: Battery to battery grounding cable(300mm)	1pcs	
		
F: Battery to battery communication cable(250mm)	1pcs	
		
<b>Wall mounted kits</b> (Packing using separately carton)	A: External hexagon slotted combination screw	6pcs
	B: Cross recessed recessed combination screw	2pcs
	C: Battery to battery parallel positive cable	1pcs
		
	D: Battery to battery parallel negative cable	1pcs
		
E: Battery to battery grounding cable	1pcs	
		
F: Cross recessed small countersunk head screws	16pcs	



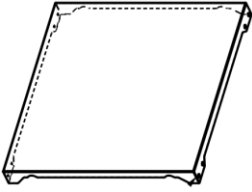
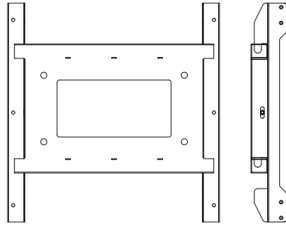
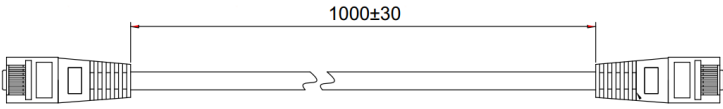
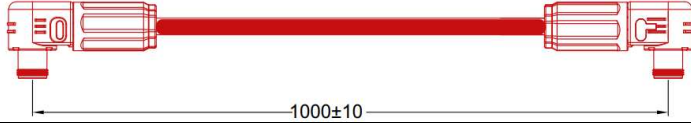
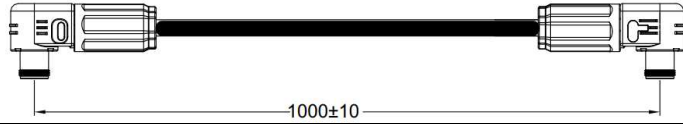
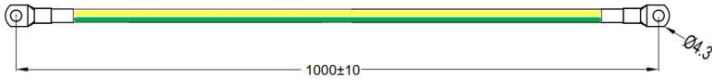
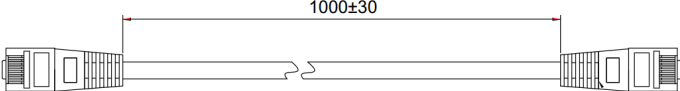

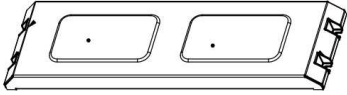
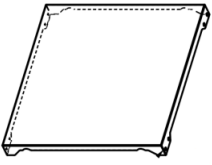
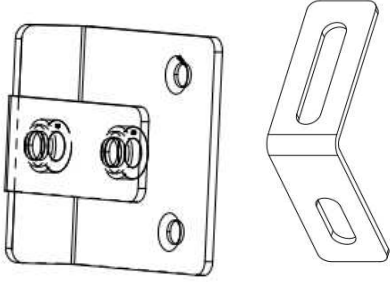
	G: Expansion bolt M10*60	4pcs
	H: Decorative panel 	1pcs
	I: Wall mounted bracket 	1pcs
	J: Battery to battery communication cable 	1pcs
<b>Floor mounted kits</b> (Packing using separately carton)	A: Outer hexagon combination bolt	4pcs
	B: Cross recessed small countersunk head screws	12pcs
	C: Battery to battery parallel positive cable 	1pcs
	D: Battery to battery parallel negative cable 	1pcs
	E: Battery to battery grounding cable 	1pcs
	F: Battery to battery communication cable 	1pcs
	G: Base	1pcs

		
	H: Decorative panel 	1pcs
	I: Side fixing parts 	2pcs
	J: Expansion bolt M6*50	6pcs

### 4.2.3 External cable kits

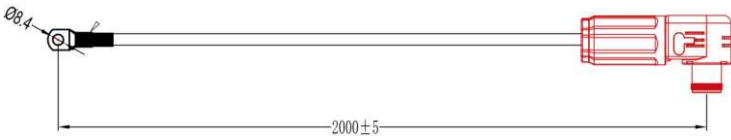
Cables connected to inverter or junction box belongs to an External Cable kits, **NOT include** in battery carton. Customers need buy it separately, the information are as below.

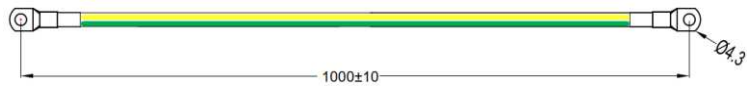
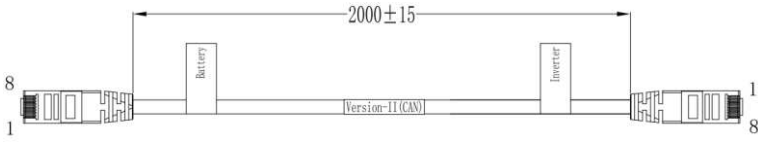
Type	Detail	Qty.
Power cable		1pcs
		1pcs
Grounding cable		1pcs
Inverter communication cable (1 out of 3)		1pcs
		<b>Battery side pin</b> <b>Inverter side pin</b>

	<b>Version I(CAN):</b>	Pin 4	Pin 7
		Pin 5	Pin 8
		Pin 6	Pin 3
	<b>Version II(CAN):</b>	Pin 4	Pin 4
		Pin 5	Pin 5
	<b>Version III(RS485):</b>	Pin 1	Pin 3
		Pin 2	Pin 5

For inverter communication PIN definition detail, please check **Appendix I**

### NOTICE

Keep the unused cable pins NULL to avoid affecting the closed loop communication.

### NOTICE

A ground connection of communication cable may be required from some inverters, please follow the rules from inverter manufacture.

#### 4.2.4 Battery registration

We recommend you to register battery to achieve extended warranty, please scan the QR code below to fulfill the correct information of your product and configuration.



#### 4.3 Start Installation

 **Qualified person**

---

### 4.3.1 Remainder

Please check again the following conditions or equipment whether meet the requirements before installation:

- Check if there's enough space for installation, and if the load-bearing capacity of the bracket or cabinet meets the weight requirements.
- Check whether the power cable pair(s) used meets the maximum current requirement for operation.
- Check whether the overall layout of power supply equipment and batteries at the construction site is reasonable.
- Check whether the installer is wearing anti-static wristband.
- Check whether there're two people on the construction site for installation work.
- Check if there's potential risks at location of installation site, e.g flooding, sun exposure, corrosion, and salt spray.

### 4.3.2 Procedures

#### CAUTION

Injuries may result if the product is lifted incorrectly or dropped while being transported or mounted. Wear suitable personal protective equipment for all work on the product.





#### CAUTION

Ensure that no lines are laid in the wall which could be damaged when drilling holes.

#### 4.3.2.1 Rack mounted



- |      |   |
|------|---|
| i.   | Take the battery pack out from carton.  |
| ii.  | Get the Rack or cabinet ready and place it horizontally at a reasonable location.   |
| iii. | Place the battery on the rack or cabinet tray via manual-lift, Insert the screws and fasten the battery to the rack or cabinet. |
| iv.  | Finish the cable connection   |

#### 4.3.2.2 Stack mounted [stack mount base is optional and is not included in the package]

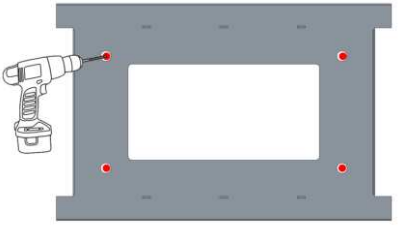
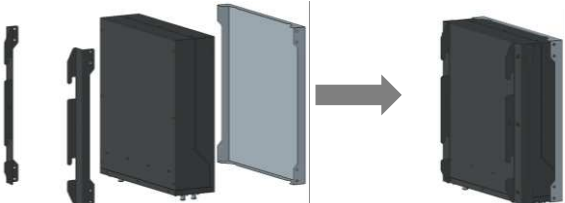
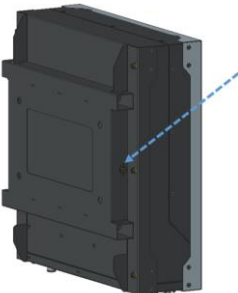

<p>i. Take the battery pack out from carton.</p>	
<p>ii. Remove the mounting ear from both side of the battery.</p>	
<p>iii. Install the stacking component at four corners of the battery.</p>	
<p>iv. Remove the hook on the stacking component of the bottom battery of each stack.</p>	
<p>v. Put another battery on top of the previous module, and align the locating holes and connect the 4 lockers together.</p>	
<p>vi. The maximum number in each stack is 4 modules.</p> <p>vii. Finish the cable connection</p>	

Note: Do not stack the batteries directly.

**4.3.2.3 Wall mounted [all mount bracket is optional and is not included in the**

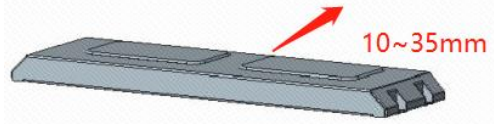
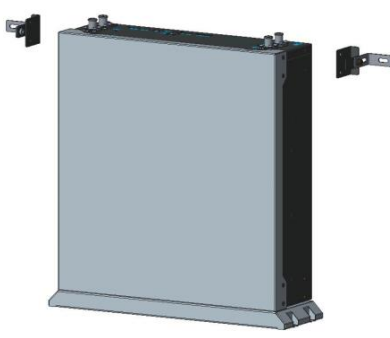

<p><b>package]</b> i. Take the battery pack out from carton.</p>	
<p>ii. Remove the mounting ear from both side of the battery, and separate the wall mounting bracket and widget.</p>	
<p>iii. Take out the wall mounting bracket, place it onto the wall horizontally and mark the hole position on the panel. iv. Drill holes in the wall for the M10 expansion bolt. The drilling depth should be at least 60 mm, insert the bolt. v. Fix the bracket with the nut</p>	
<p>vi. Fix the wall mounting widget and the decorative panel with the battery using the combination screw</p>	
<p>vii. Lift the battery up and put the hook into the bracket hanging hole, fix the widget with the bracket via the combination screw and tighten it using a screwdriver</p>	
<p>viii. Finish the cable connection</p>	

**4.3.2.4 Floor mounted [floor mount base is optional and is not included in the**



<p><b>package]</b> i. Take the battery pack out from carton.</p>	
<p>ii. Remove the mounting ear from both side of the battery.</p>	
<p>iii. Place the base near the wall, align with the wall and make sure the distance is between 10mm and 35mm. iv. Drill holes on the ground for the M6 expansion bolt. The drilling depth should be at least 50 mm, insert the bolt. (this step is optional) v. Fix the base with nut. (this step is optional)</p>	
<p>vi. Fix the decorative panel and wall hang ear with the battery using the combination screw, and place the battery onto the base. vii. Adjust the position of the hang ear, make sure they can connect wall smoothly, mark the hole position of both hang ear.</p>	
<p>viii. Remove hang ear from the battery, and drill holes in the wall for the M6 expansion bolt. The drilling depth should be at least 50 mm, insert the bolt. ix. Fix the hang ear with battery and fasten the bolt with nut.</p>	
<p>i. Finish the cable connection</p>	

**4.3.3 Tips**

**4.3.3.1 Installation not allowed**

Direct upside down	Left side flip	Right side flip
 <p style="text-align: center; color: red; font-weight: bold; font-size: 2em;">X</p>	 <p style="text-align: center; color: red; font-weight: bold; font-size: 2em;">X</p>	 <p style="text-align: center; color: red; font-weight: bold; font-size: 2em;">X</p>

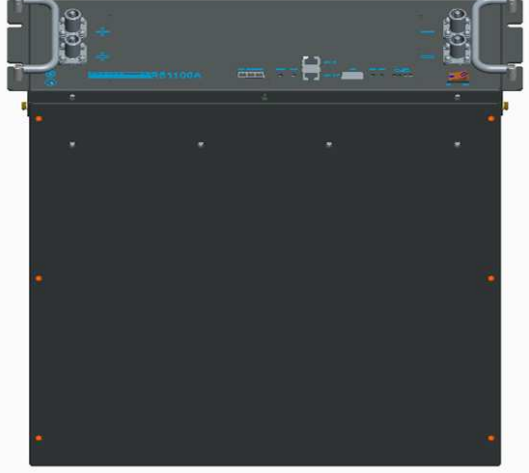
#### 4.3.3.2 Other Installation

Hang on the wall with Holder	Placing on the desk
 <p>Please make sure the holder can handle a minimum weight of 50kg</p>	 <p>Please make sure the desk can bear the total weight.</p>

### NOTICE

ANY others installations, please avoid the battery directly contacting the ground and avoid of high salinity, humidity to prevent the product from rusting and corrosion.



---

## 5. Cable connection and commissioning

 **Qualified person**

### 5.1 Get battery ready

5.1.1 Ensure all the battery is in OFF mode, check and confirm the installation is tighten and stable.

5.1.2 Check the number and specification of cable kit accessories are correct according to the Scope of delivery item, if you are making cable yourself, please follow manufacturer's requirements.

5.1.3 Switch on all battery individually before wiring, check whether there is any alarm/protection information, if yes, turns to troubleshooting. Then switch off all batteries.

### 5.2 Grounding cable connection

5.2.1 Take out the grounding screw on the battery panel, and get the cable conductor through it.

5.2.2 Fix them together, with a cylinder screwdriver and tighten it.

5.2.3 Connect the grounding cable with next battery module.

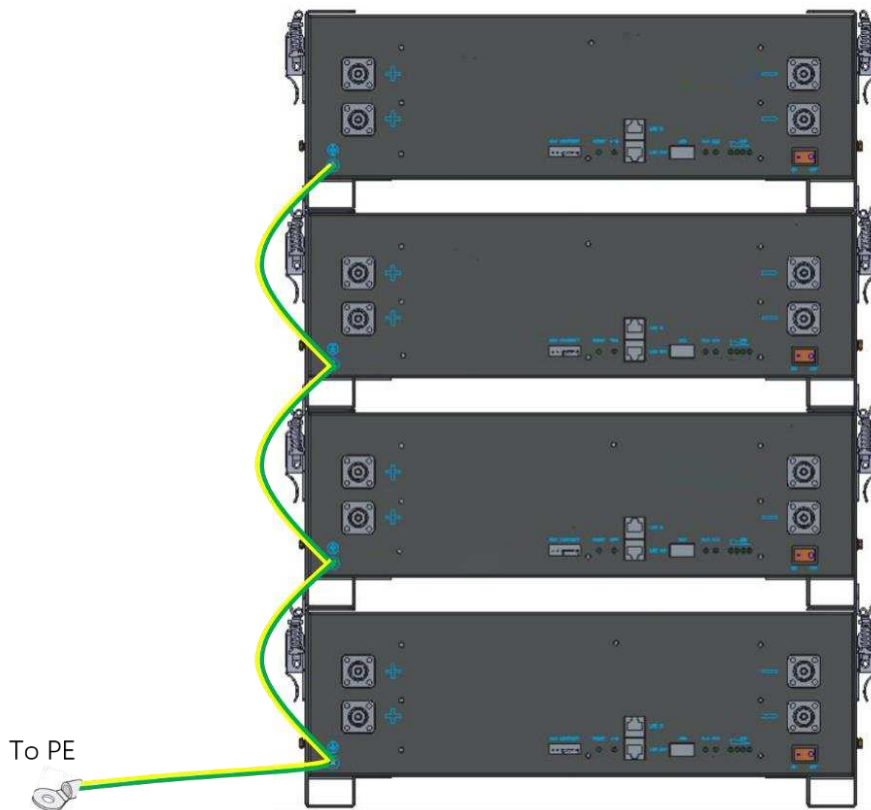

---

## 5.3 Communication cable connection

5.3.1 Take out battery to battery communication cable.

5.3.2 Confirm the location of Master battery, insert the RJ45 plug into the Link Out port and connect the other side to next battery Link IN port, daisy chained all batteries.

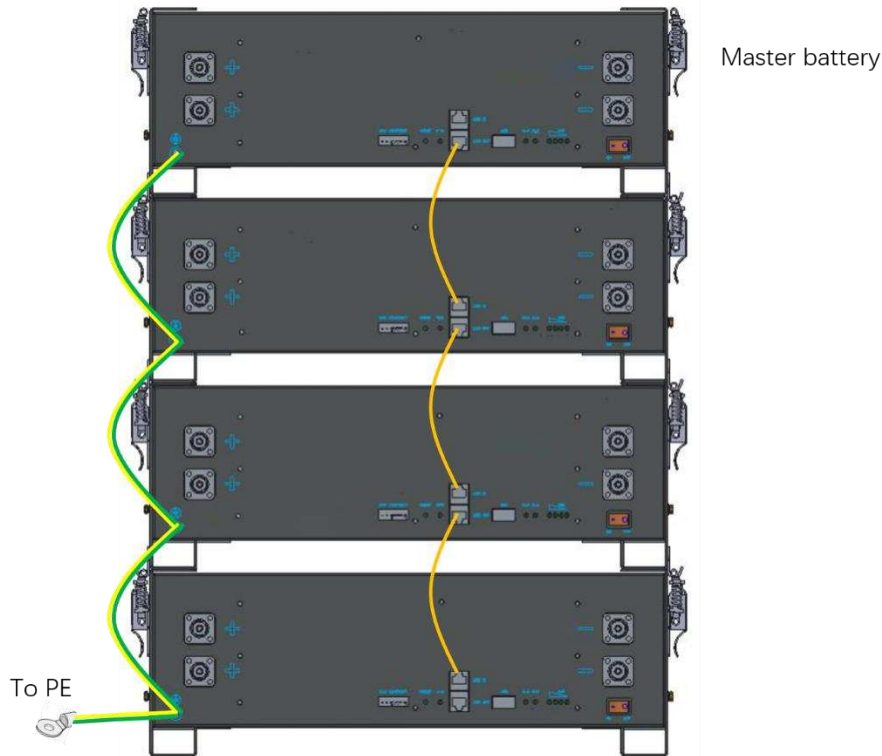

Note: the module with empty Link IN port is Master battery

### **NOTICE**

The BMS inside the battery pack will automatically terminate BOTH end of CANBUS pins, DO NOT need to plug the 120  $\Omega$  terminator again.

## 5.4 DC power cable connection

5.4.1 Take out battery to battery power parallel cable.

5.4.2 Insert the Plug into the power socket until you hear the 'click' sound.

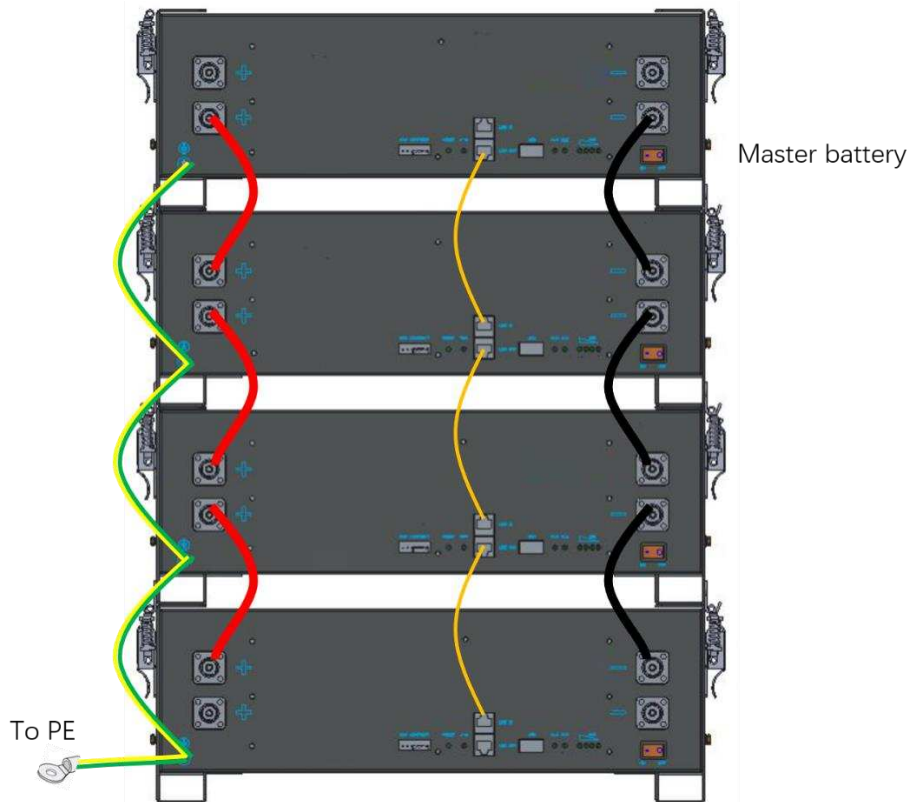

## 5.5 Connecting with inverter

### ⚠ CAUTION

Confirm inverter AC input and PV input is disconnected before wiring connection, and the DC/ signal switch of inverter/charger is in off status.

5.5.1 Connecting Master battery Link IN port with inverter CAN or RS485 communication port via inverter communication cable (*Version I/II/III or customized*).

5.5.2 Connecting battery OUTPUT (+) with inverter battery INPUT (+), battery OUTPUT (-) with inverter battery INPUT (-), an external disconnection breaker between battery system and inverter is recommended, choose the corresponding power cable pair and wiring them correctly.

#### Note:

### ⚠ NOTICE

Choose the suitable disconnection breaker considering the inverter power/current, rated voltage, tripping characteristic etc.

✓ Wiring diagram allowed:

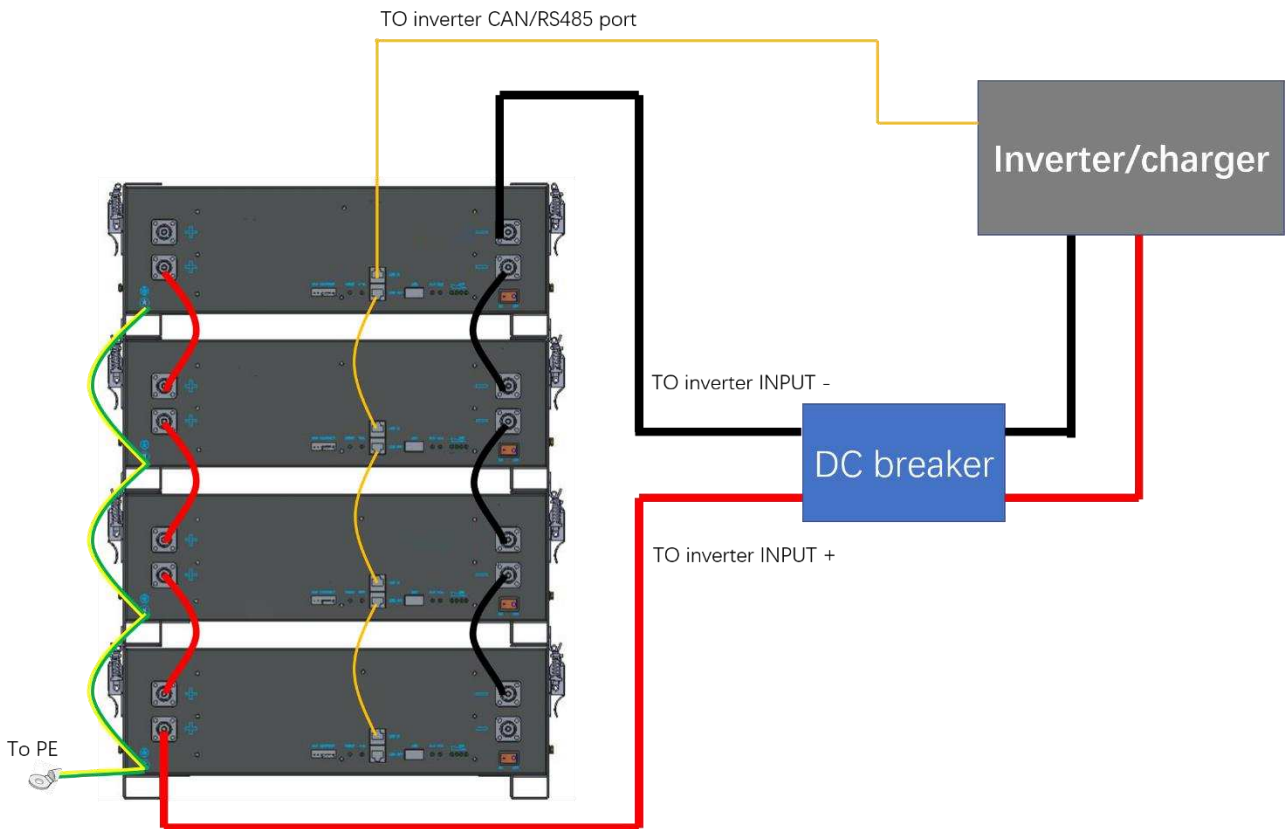
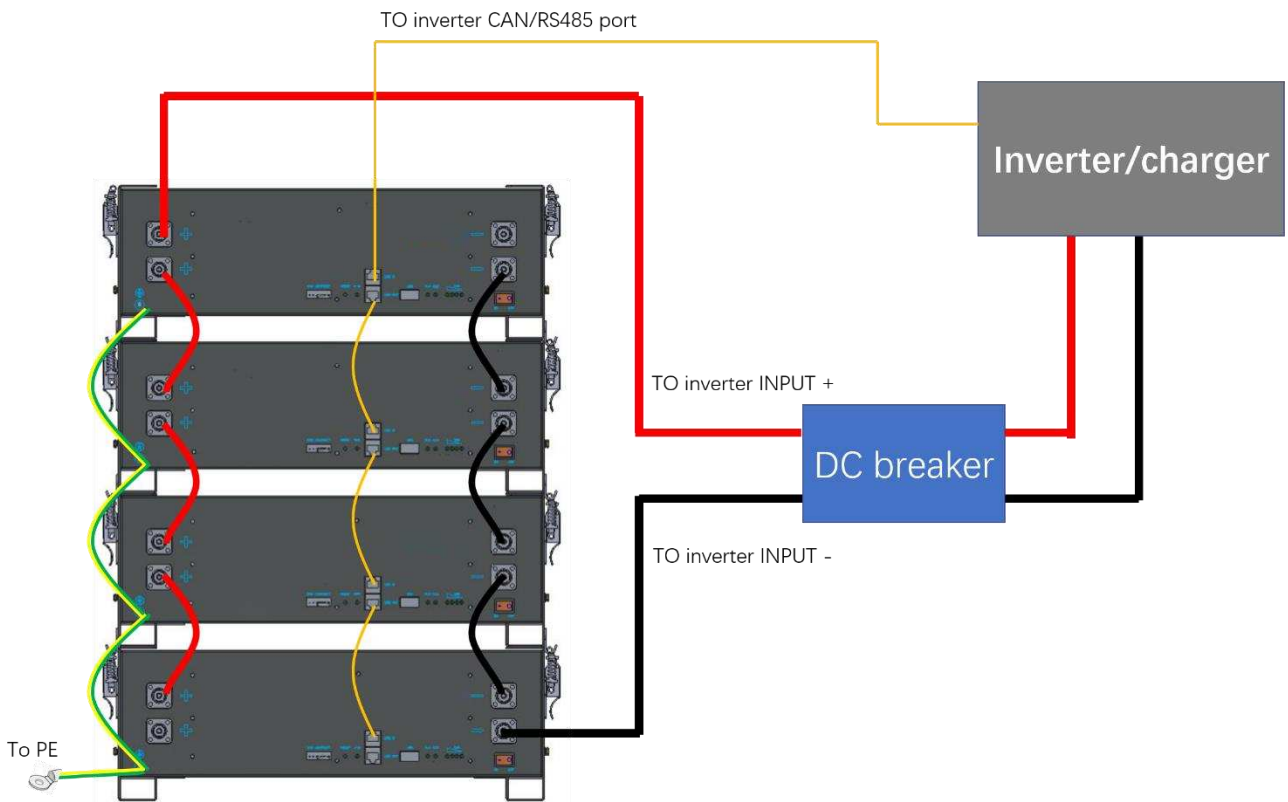

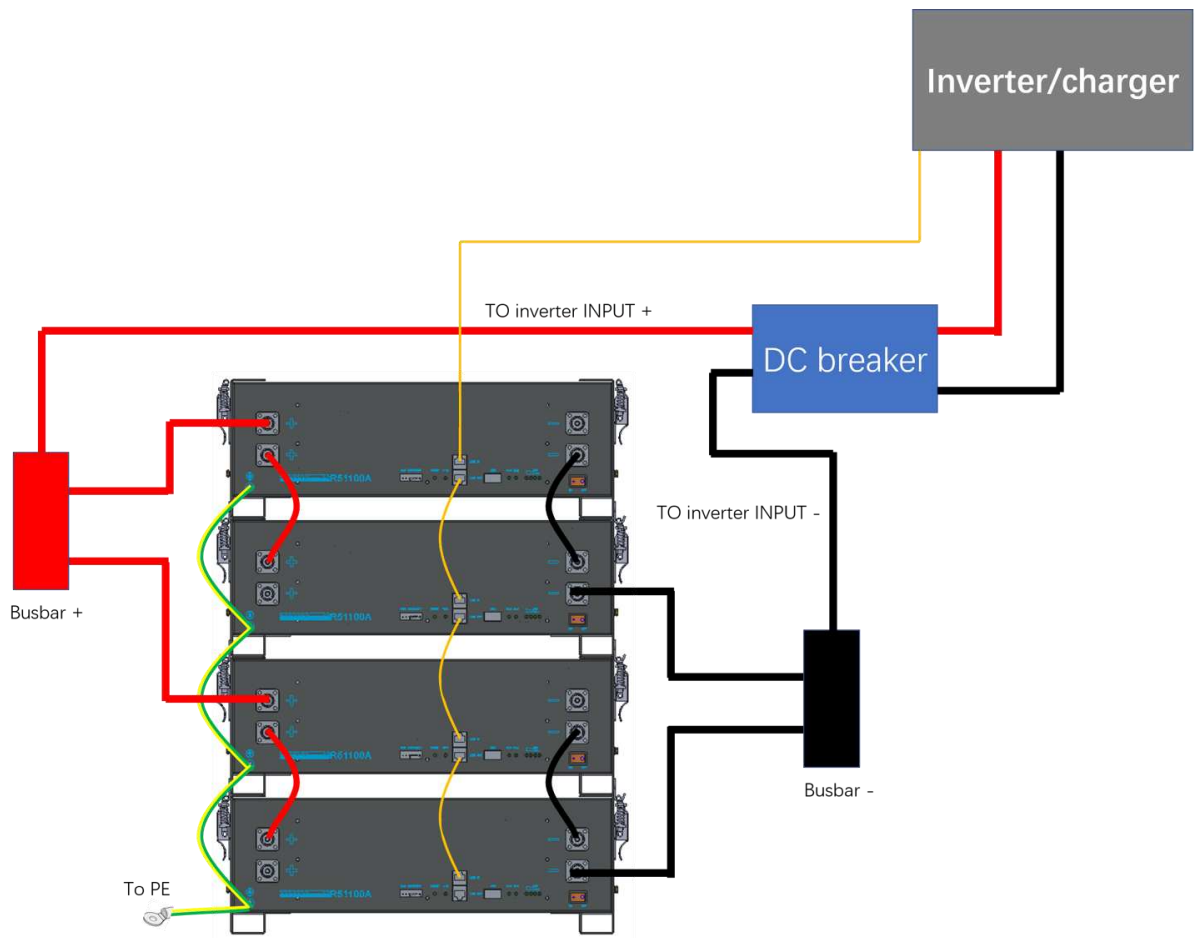

✗ Wiring diagram not allowed:

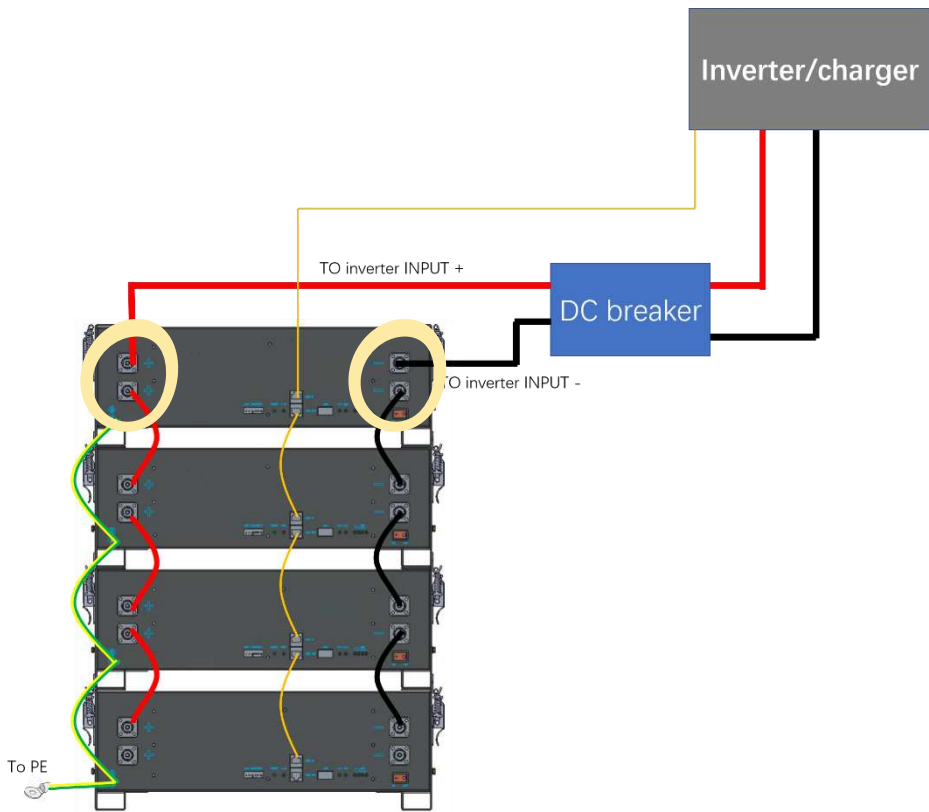

## ⚠ NOTICE

The maximum communication cable length is required to be less than 15m between inverter/charge and battery.

The maximum power cable length is suggested to be less than 10m between inverter/charge and battery.

### **For Australia market ONLY**

In order to meet the AS/NZS 5139:2019 installation standard, a battery disconnection breaker is a mandatory between each battery module and inverter, please choose appropriate breaker following the standard.

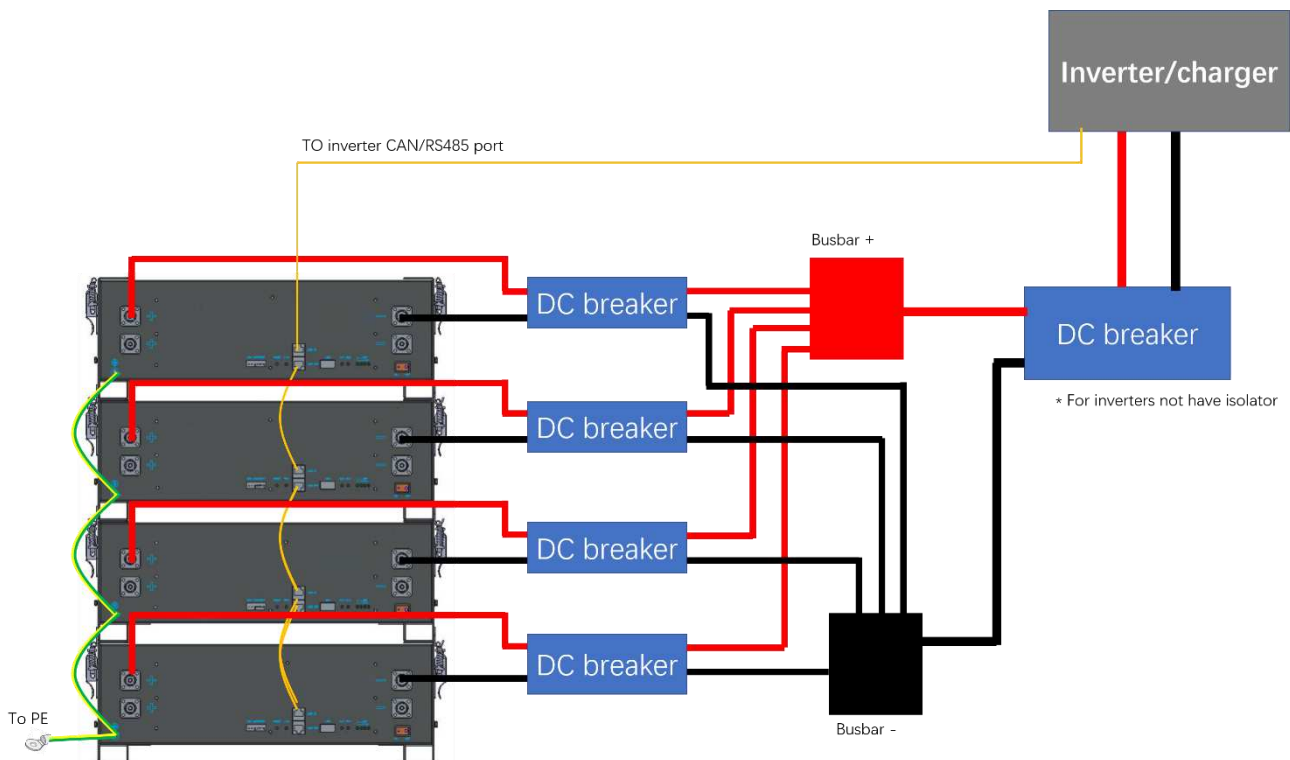

For other type of installation, please also follow the rules above to wiring your system.

## ⚠ CAUTION

The maximum tolerance current of each power cable and terminal is 125A, 100A for continuously is suggested, please use corresponding number of power cable pairs according to the field configuration and local connection requirements, standards, and directives.

## 5.6 Commissioning

5.6.1 Set the DIP address of the Master battery (and the Slave battery if there is any RS485 baud rate changed).

5.6.2 Switch on all battery modules, wait for 10s, make sure that only M/S led is on Master battery.

5.6.3 Turn on the breaker between the inverter and battery if there is any, then turn on the inverter/charger isolator.

5.6.4 Finish the setting on inverter/charger or any other control devices, if everything is correct, you are ready to use the system.

No.	Inverter setting parameters	Detail
1	Absorption voltage	56.0V
2	Float voltage	54.6V
3	Re-charge/Generator start voltage	$\geq 50V$
4	Re-start voltage	52V
3	Low SOC limit (Grid-tied)	10/20% (differ from inverter brand)
5	Low SOC cut-off	4%
6	Low Voltage cut-off	48.0V
7	Rated charging current limited value	50A*N (N is the Quantity of the battery pack)
8	Rated discharging current limited value	50A*N (N is the Quantity of the battery pack)
9	Max. charging current limited value	70A*N (N is the Quantity of the battery pack)
10	Max. discharging current limited value	100A*N (N is the Quantity of the battery pack)
11	Force charge	Enable

For more information to connect with different inverter/charger, please contact your supplier for technical support.

### CAUTION

If your system is a back-up or off-grid system, make sure your configuration can cover the worst situation to avoid battery to be over-discharged.

## 5.7 Switch off battery

5.7.1 Turn off the inverter.

5.7.2 Turn off the disconnection breaker if there is any.

5.7.3 Turn off all batteries signal switch.

## 5. Troubleshooting and FAQ

Items	Solution	Measure
Unable to start	<ol style="list-style-type: none"> <li>1. Power on battery and press RESET 6s to observe whether the battery can be started.</li> <li>2. Charge the battery use a charger or inverter to provide 54~57.6V voltage and observe it can be started.</li> </ol>	<p>If the abnormal status still ON after above steps, please contact your supplier.</p> <p>If there is any other situation(s) excluding in this table, turn off the fault battery, contact your supplier.</p>
Unable to charge	<ol style="list-style-type: none"> <li>1. Check whether the cable connection between the battery and the inverter/charger is correct.</li> <li>2. Check whether the inverter/charger setting is correct.</li> <li>3. Check whether the battery is in charge protection mode, if yes, try to discharge the battery.</li> </ol>	
Unable to discharge	<ol style="list-style-type: none"> <li>1. Check whether the cable connection between the battery and the inverter/charger is correct</li> <li>2. Check whether the battery occurs short circuit, reverse connection, pre-charge failure during connection inverter etc.</li> <li>3. Check whether the battery is in discharge protection mode, if yes, try to charge the battery.</li> </ol>	
High/Low temperature	<ol style="list-style-type: none"> <li>1. Stop the battery system for a while, check whether the installation location temperature meet the requirement.</li> <li>2. Avoid continuous full charging and discharging.</li> </ol>	
High current	Check the configuration and parameters setting on the inverter/charger is correct.	
ALM always on	Turn off all the batteries, and remove the fault battery from the system, ask your supplier	
Communication fail	<ol style="list-style-type: none"> <li>1. Check the communication cable type is correct and is contacted well.</li> <li>2. Check the DIP switch setting is correct.</li> <li>3. Check the inverter protocol related setting is correct.</li> <li>4. Check both battery and inverter are working properly.</li> </ol>	

**Q1: Battery maximum SOC is 99% and never goes to 100%SOC during daily cycle use, why?**

Generally, there is no effect to system on this point. BMS will calibrate the SOC to 100% when reached cut-off current or trigger CHVP, however, to avoid battery from being overcharged and to extend the cycle life as longer as possible, we left a room and set a charging profile to let battery not be charged at high voltage near full. Keep float the battery for approximately 0.5~1 hour to calibrate.

**Q2: 'High voltage' and 'cell unbalance' warning and alarm in rare cases, does it mean battery is damaged?**



---

No. This is not unusual and happened on new batteries that are not balanced yet, please lower the maximum charge voltage (54.6V) and float the battery via grid or generator. If not solved, please contact your supplier.

**Q3: *When having multiple batteries in parallel connection, the battery on the end can't be fully charged.***

Pay attention to your wiring diagram, please always follow the manual wiring advises and choose proper cable size and pair.

**Q4: *The current is 0A when connecting with a very small load at the situation that having multiple batteries in parallel connection, how to solve it?***

Each BMS has a threshold current of 0.5A (~25W) before it begins to report, this leads the inaccurate display of the current.

**Q5: *SOC suddenly jump to 100% during charging.***

This is normal in off-grid application and usually happened on batteries that not been calibrated SOC for long time, we suggest to fully charge the batteries 1 time per month.

---

## 6. Transport, Storage

- Do not violently shake, impact or squeeze, and prevent sun and rain during the transportation.
- Prevent battery from falling, rolling, and heavy pressure during loading and unloading.
- The battery should be placed in a dry, clean and well-ventilated indoor environment for long-term storage, the recommended storage temperature range is 15~30 °C
- Keep away from harmful gases, flammable and explosive products and corrosive chemical substances in the storage location.
- The batteries should be stored and transported in close to 50% SOC, do not store over 80%SOC for long time.
- If battery is not in use for a long time, the battery will need to be charged every 6 months.
- Do not drop, stack more than 6 batteries or place the battery face down on the ground.

---

## **7. Disposal of battery**

Disposal of battery must comply with the local applicable disposal regulations for electronic waste and used batteries, please review your local Battery recycling or management regulations or contact your supplier for more information.

# Appendix I

## Connect with Victron GX & inverter/charger

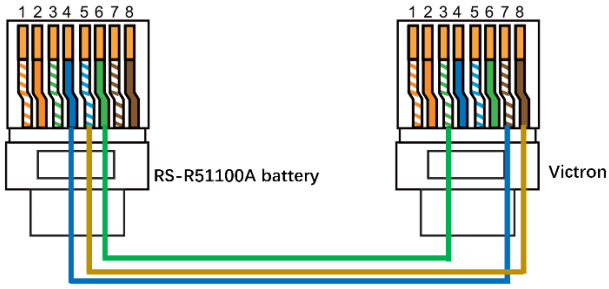

Battery Link IN port	Victron VE.CAN/BMS CAN	Cable suggest
Pin4	Pin7	Version-I(CAN)
Pin5	Pin8	
Pin6	Pin3	

## Connect with SMA inverter/charger

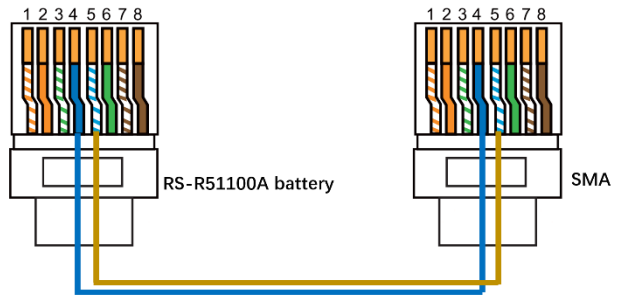

Battery Link IN port	SMA sunny island	Cable suggest
Pin4	Pin4	Version-II(CAN)
Pin5	Pin5	
Pin6 (optional)	Pin2 (optional)	

## Connect with Schneider inverter/charger

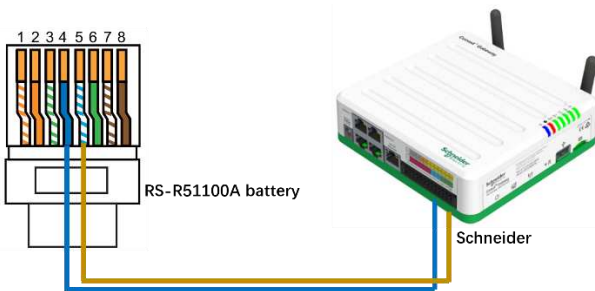

Battery Link IN port	Conext Gateway	Cable suggest
Pin4	Pin14	customized
Pin5	Pin12	
Pin6 (optional)	Pin10 (optional)	

## Connect with Studer inverter/charger

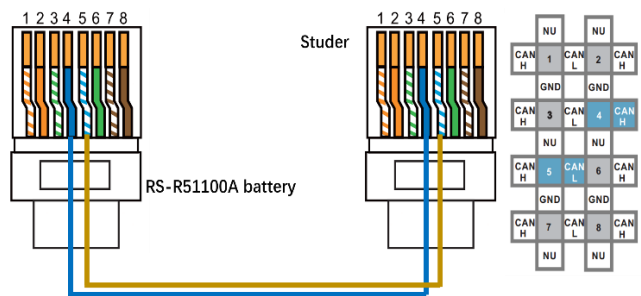

Battery Link IN port	X-Com CAN	Cable suggest
Pin4	Pin4	Version-II(CAN)
Pin5	Pin5	

## Connect with GOODWE hybrid inverter

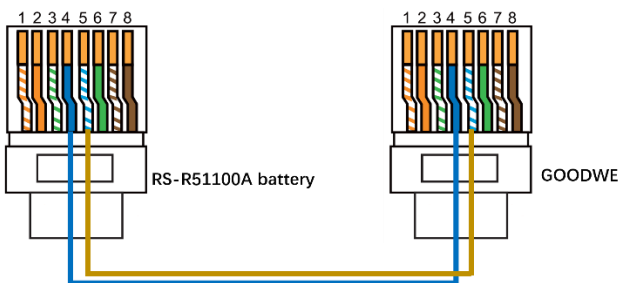

Battery Link IN port	GOODWE BMS CAN	Cable suggest
Pin4	Pin4	Version-II(CAN)
Pin5	Pin5	

## Connect with Sol-Ark hybrid inverter

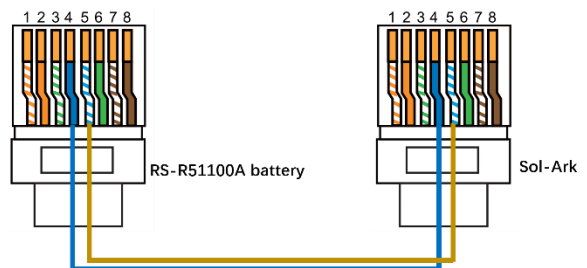

Battery Link IN port	Sol-Ark CAN	Cable suggest
Pin4	Pin4	Version-II(CAN)
Pin5	Pin5	
Pin6 (optional)	Pin6 -outdoor Pin2 -indoor (optional)	

## Connect with Growatt inverter

## Connect with Solis inverter

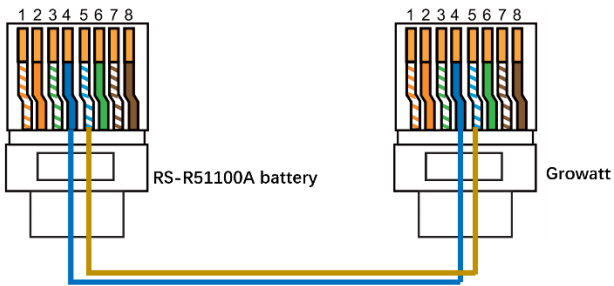

Battery Link IN port	Growatt BMS communication port	Cable suggest
Pin4	Pin4	Version-II(CAN)
Pin5	Pin5	

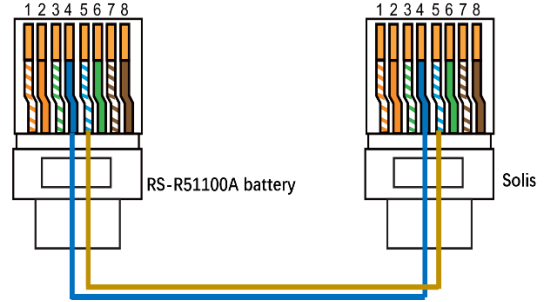

Battery Link IN port	Solis CAN	Cable suggest
Pin4	Pin4	Version-II(CAN)
Pin5	Pin5	

### Connect with Deye hybrid inverter

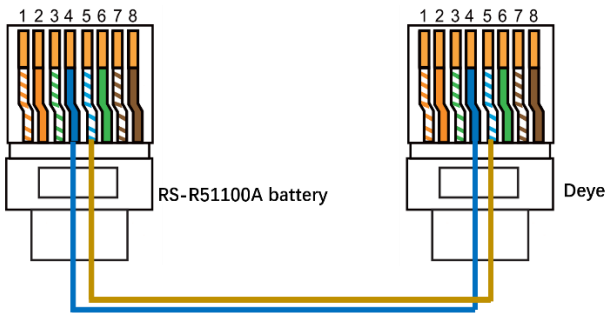

Battery Link IN port	Deye CAN	Cable suggest
Pin4	Pin4	Version-II(CAN)
Pin5	Pin5	

### Connect with SUNSYNK hybrid inverter

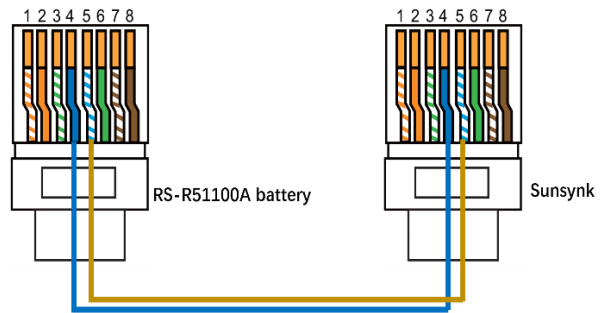

Battery Link IN port	Sunsynk CAN	Cable suggest
Pin4	Pin4	Version-II(CAN)
Pin5	Pin5	

### Connect with SAJ hybrid inverter

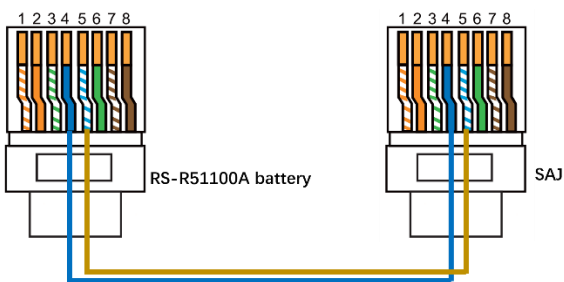

Battery Link IN port	SAJ CAN	Cable suggest
Pin4	Pin4	Version-II(CAN)
Pin5	Pin5	

### Connect with LUXPOWER inverter

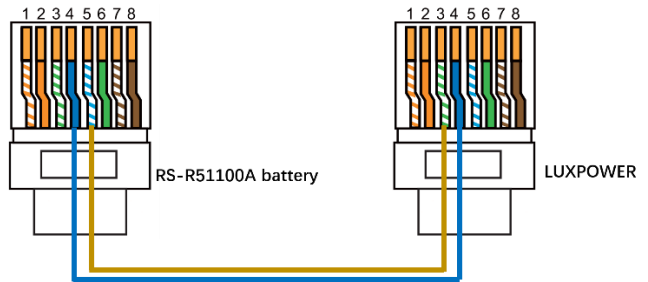

Battery Link IN port	LUXPOWER CAN	Cable suggest
Pin4	Pin4	customized
Pin5	Pin3	

### Connect with Megarevo/INVT inverter

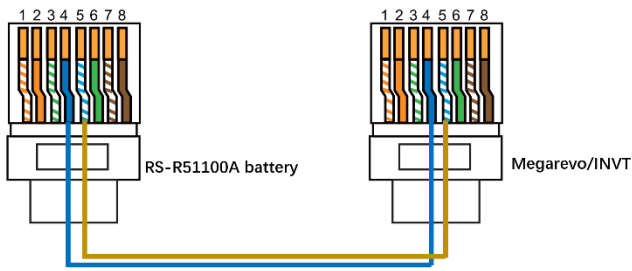

Battery Link IN port	Megarevo CAN	Cable suggest
Pin4	Pin4	Version-II(CAN)
Pin5	Pin5	

### Connect with MUST inverter

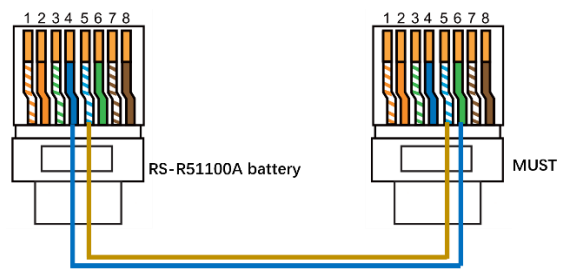

Battery Link IN port	MUST CAN	Cable suggest
Pin4	Pin6	customized
Pin5	Pin5	

### Connect with Alpha & Outback energy inverter

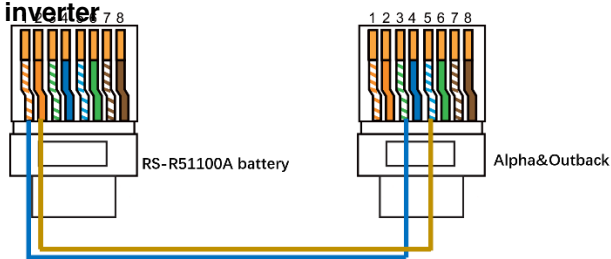

Battery Link IN port	Alpha&Outback BMS communication	Cable suggest
Pin1	Pin3	Version-III(RS485)
Pin2	Pin5	

### Connect with MapleLeaf

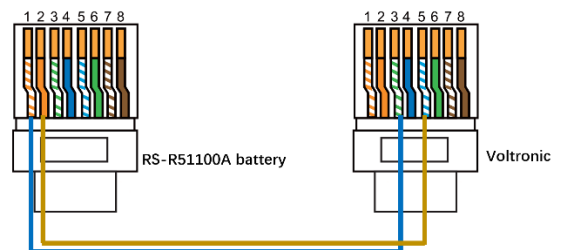

Battery Link IN port	Voltronic BMS communication	Cable suggest
Pin1	Pin3	Version-III(RS485)
Pin2	Pin5	

### Connect with Phocos inverter

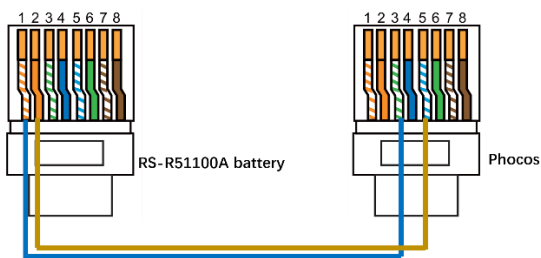

Battery Link IN port	Phocos BMS communication	Cable suggest
Pin1	Pin3	Version-III(RS485)
Pin2	Pin5	

### Connect with Mpp solar inverter

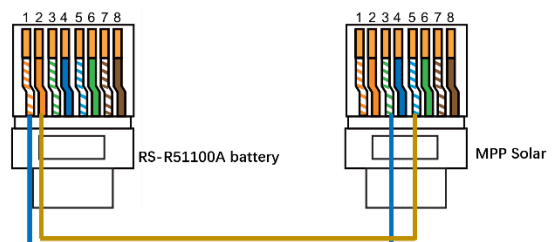

Battery Link IN port	MPP BMS communication	Cable suggest
Pin1	Pin3	Version-III(RS485)
Pin2	Pin5	



Maple Leaf Power Systems Ltd  
Address: 102 Commerce Park Drive Unit 11, Barrie ON  
Postcode: L4N8W8  
Tel: +1 705-242-  
2907  
Web: [www.mapleleafpowersystems.com](http://www.mapleleafpowersystems.com)