

VINCENT SHEPPARD



OUTDOOR COLLECTION 2022

OUR PHILOSOPHY

We are convinced that shared moments outdoors are the ones which will last a lifetime. Be it playing with your children in the garden, spending a lovely afternoon on a cosy terrace, or relaxing by the pool on holiday. The hours and days spent under the open sky will be amongst your most precious memories.

Therefore, Vincent Sheppard created an outdoor collection to accommodate those moments of happiness. With a conscious mindset and passion for skilled craftsmanship, we aim to create timeless furniture which will enhance your outdoor space. Enabling you to put your own stamp on your environment by choosing for unique designs which are meant to last.

By combining Belgian design with the rich Indonesian weaving tradition, we are able to present beautiful outdoor pieces to be treasured now and forever. We offer an all-weather furniture collection, which can be left outside all year long, and a range of outdoor Lloyd Loom products which allows you to bring the distinct look of Lloyd Loom furniture outside. Made with care from Belgium to Indonesia and back.

To enjoy your moments.

The Vincent Sheppard team

INDEX

COLLECTIONS

ANTON	62	LUCY	116
BISTRO TABLES	128	MATTEO	68
CLIFF	112	MAX	129
DAVID	32	MIA	130
EDGARD	68	MONA	126
FRIDA	58	MORA	64
GIPSY	133	OLAF	137
IVO	110	OTTO	137
KENZO	130	ROXANNE	88
KODO	14	ROXY	86
LENA	74	ROY	89
LENTO	2	ROZY	109
LEO	76	SAFI	138
LIGHT MY TABLE	73	TIKA	66
LOOP	96	TOUNDRA	112
LLOYD LOOM	148	WICKED	44

TECHNICAL INFORMATION	162
-----------------------	-----

FABRICS	166
---------	-----

PRODUCT OVERVIEW	168
------------------	-----



LENTO LOUNGE CHAIR, MODULAR CHAISE LONGUE RIGHT, MODULAR CORNER LEFT

LENTO LOUNGE SOFA 2.5S AND COFFEE TABLES
CLIFF RUG



LENTO LOUNGE SOFA 3S, COFFEE TABLES
CLIFF OUTDOOR RUG

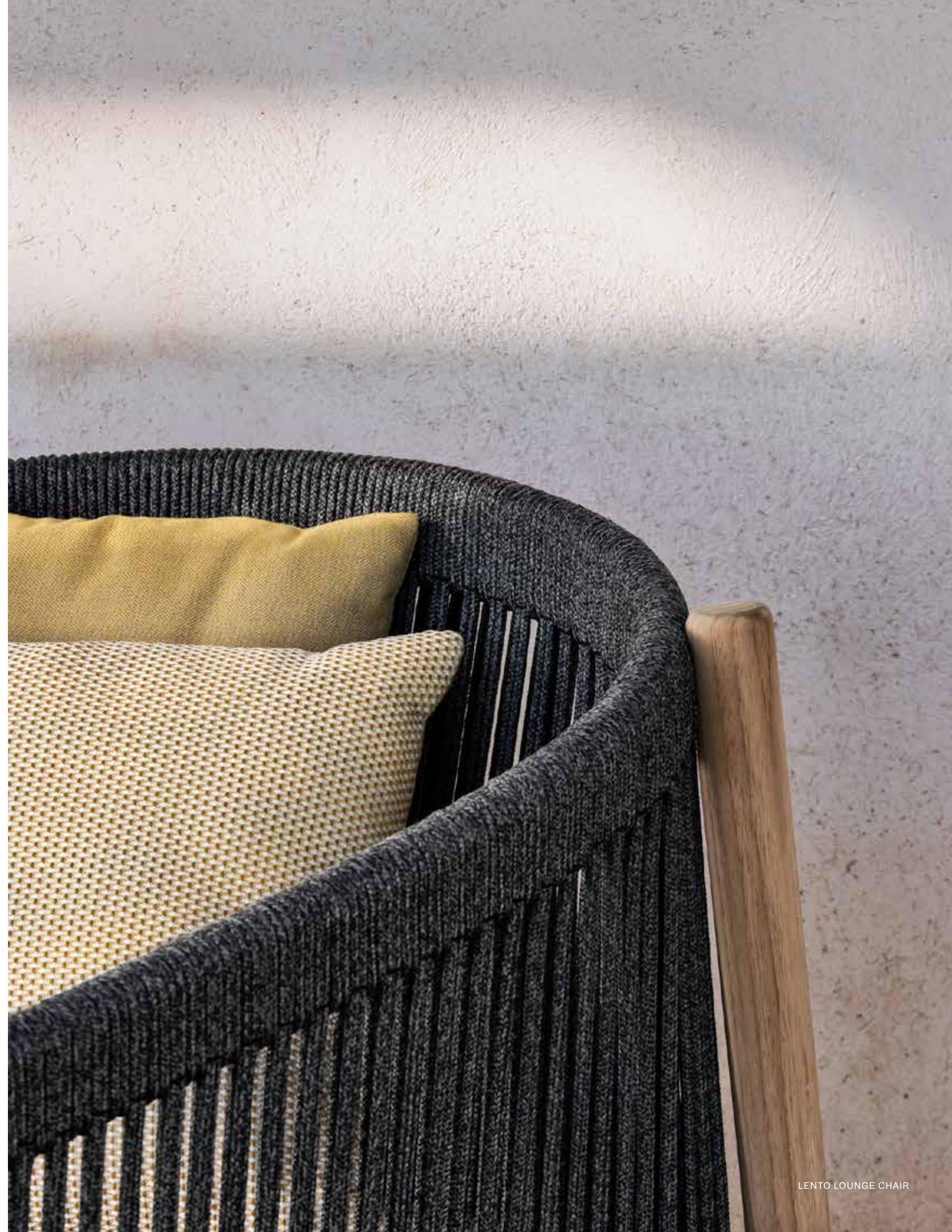

LENTO LOUNGE CHAIR



LENTO LOUNGE CHAIR, MODULAR CHAISE LONGUE RIGHT, MODULAR CORNER LEFT

LENTO LOUNGE SOFA 2.5S AND COFFEE TABLES
CLIFF RUG
IVO PLANT STAND SMALL



LENTO LOUNGE CHAIR AND SIDE TABLE



LENTO LOUNGE SOFA 2.5S, COFFEE AND SIDE TABLE

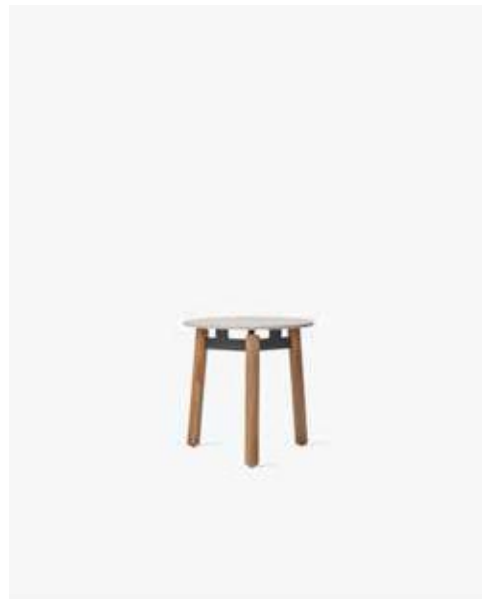

LENTO SIDE TABLE DIA 45

MATERIALS
untreated teak
aluminium frame
ceramic top

DIMENSIONS
Ø 45 cm

COLOURS
untreated teak / portland ceramic

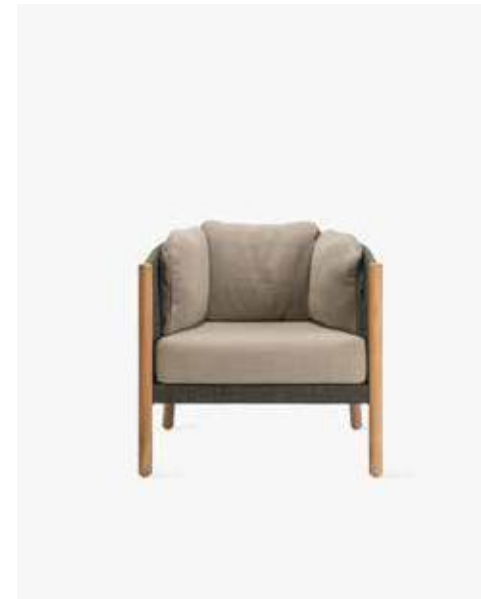
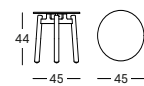

LENTO LOUNGE CHAIR

MATERIALS
untreated teak
polypropylene rope

CUSHIONS
seat 12 cm quick dry foam
back polyester fibre filling
fabrics see page 166 - 167

COLOURS
untreated teak / anthracite rope

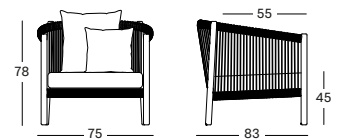

LENTO COFFEE TABLE DIA 68

MATERIALS
untreated teak
aluminium frame
ceramic top

DIMENSIONS
Ø 68 cm

COLOURS
untreated teak / portland ceramic

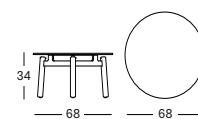

LENTO LOUNGE SOFA 2.5S

MATERIALS
untreated teak
polypropylene rope

CUSHIONS
seat 12 cm quick dry foam
back polyester fibre filling
fabrics see page 166 - 167

COLOURS
untreated teak / anthracite rope



LENTO COFFEE TABLE DIA 90

MATERIALS
untreated teak
aluminium frame
ceramic top

DIMENSIONS
Ø 90 cm

COLOURS
untreated teak / portland ceramic

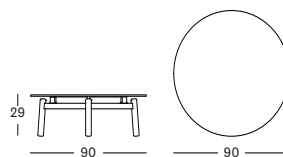

LENTO LOUNGE SOFA 3S

MATERIALS
untreated teak
polypropylene rope

CUSHIONS
seat 12 cm quick dry foam
back polyester fibre filling
fabrics see page 166 - 167

COLOURS
untreated teak / anthracite rope

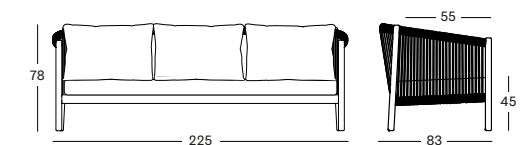



LENTO MODULAR CORNER RIGHT

MATERIALS
untreated teak
polypropylene rope

CUSHIONS
seat 12 cm quick dry foam
back polyester fibre filling
fabrics see page 166 - 167

COLOURS
untreated teak / anthracite

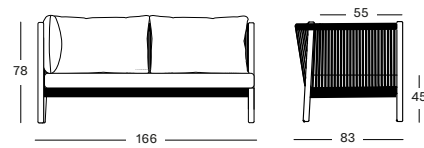

LENTO MODULAR CHAISE LONGUE LEFT

MATERIALS
untreated teak
polypropylene rope

CUSHIONS
seat 12 cm quick dry foam
back polyester fibre filling
fabrics see page 166 - 167

COLOURS
untreated teak / anthracite

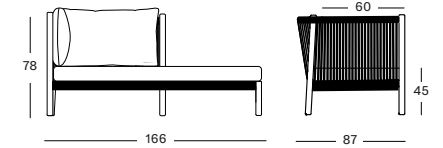

LENTO MODULAR CORNER LEFT

MATERIALS
untreated teak
polypropylene rope

CUSHIONS
seat 12 cm quick dry foam
back polyester fibre filling
fabrics see page 166 - 167

COLOURS
untreated teak / anthracite

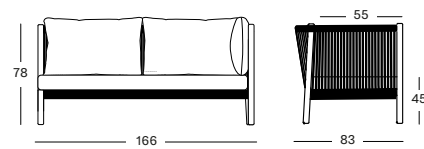

LENTO MODULAR CHAISE LONGUE RIGHT

MATERIALS
untreated teak
polypropylene rope

CUSHIONS
seat 12 cm quick dry foam
back polyester fibre filling
fabrics see page 166 - 167

COLOURS
untreated teak / anthracite

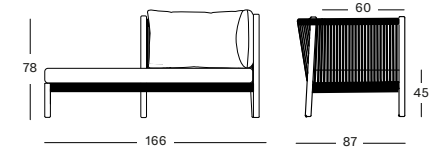

LENTO MODULAR CONNECTING SIDE TABLE

MATERIALS
polypropylene rope
ceramic top

DIMENSIONS
69 x 37 cm

COLOURS
anthracite / portland ceramic



LENTO MODULAR FOOTREST

MATERIALS
untreated teak
polypropylene rope

CUSHIONS
seat 12 cm quick dry foam
back polyester fibre filling
fabrics see page 166 - 167

COLOURS
untreated teak / anthracite

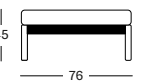



KODO LOUNGE SOFA, LOUNGE CHAIR AND COFFEE TABLE



KODO COCOON, SOFA, LOUNGE CHAIR, SIDE TABLE AND COFFEE TABLE
TOUNDRA OUTDOOR RUG





KODO COCOON AND SIDE TABLE



KODO DINING TABLE AND DINING CHAIRS



KODO COCOON, LOUNGE SOFA, LOUNGE CHAIR, SIDE TABLE AND COFFEE TABLE



KODO DAYBED
MORA LAMP MEDIUM AND LARGE

RESIDENTIAL PROJECT

SANTANYI
SPAIN

The house, which was in a dilapidated state, was transformed into a stunning villa. With respect for authentic materials and contrasting contemporary materials, design studio Marga Comas sought out the furniture which blended in perfectly.



© MARGA COMAS INTERIOR DESIGN | CAMAL FOTOGRAFIA

KODO COCOON AND FOOTREST



KODO DINING CHAIR

MATERIALS
powder coated aluminium
polypropylene rope

CUSHION
seat 4 cm quick dry foam
fabrics see page 166 - 167

COLOURS

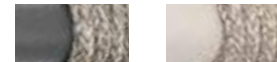

FOSSIL GREY **DUNE WHITE**

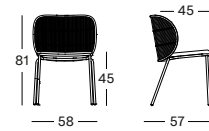

KODO LOUNGE SOFA

MATERIALS
powder coated aluminium
polypropylene rope

CUSHIONS
seat 12 cm quick dry foam
back cushions 2x (50x50), 3x (40x40)
fabrics see page 166 - 167

COLOURS



FOSSIL GREY **DUNE WHITE**

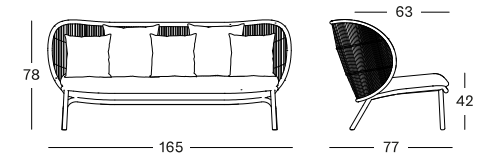

KODO COCOON

MATERIALS
powder coated aluminium
polypropylene rope

CUSHIONS
seat 12 cm quick dry foam
back cushions 1x (60x60), 2x (40x40) or
back polyester fibre filling and 1x (35x50)
fabrics see page 166 - 167

COLOURS



FOSSIL GREY **DUNE WHITE**

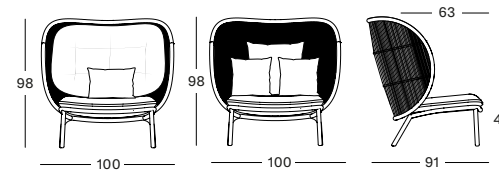

KODO LOUNGE CHAIR

MATERIALS
powder coated aluminium
polypropylene rope

CUSHIONS
seat 12 cm quick dry foam
back cushions 1x (50x50), 1x (40x40)
fabrics see page 166 - 167

COLOURS

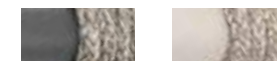

FOSSIL GREY **DUNE WHITE**

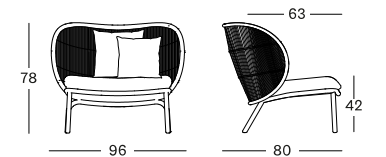

KODO FOOTREST

MATERIALS
powder coated aluminium

CUSHION
footrest 12 cm quick dry foam
fabrics see page 166 - 167

COLOURS



FOSSIL GREY **DUNE WHITE**

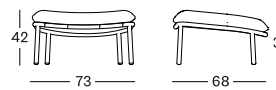

KODO DINING TABLE

MATERIALS
powder coated aluminium
ceramic top

DIMENSIONS
210 x 100 cm
280 x 106 cm

COLOURS



FOSSIL GREY FLINT **DUNE WHITE SHARDS**

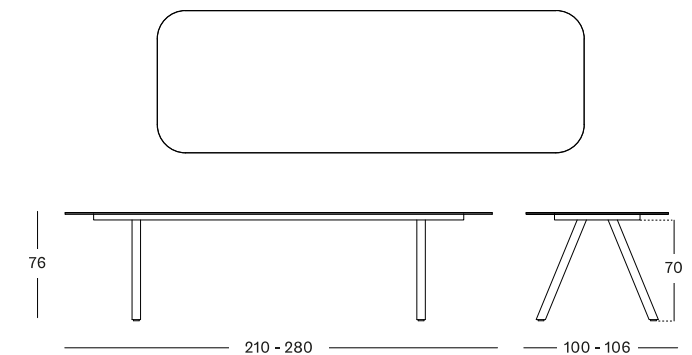



KODO COFFEE TABLE

MATERIALS
powder coated aluminium
ceramic or aluminium top

DIMENSIONS
129 x 45 cm

COLOURS



**FOSSIL GREY
FLINT**



**DUNE WHITE
SHARDS**

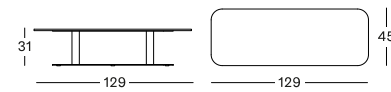

KODO ROCKING CHAIR

MATERIALS
powder coated aluminium
polypropylene rope

CUSHIONS
seat 12 cm quick dry foam
back cushions 1x (60 x 60), 2x (40 x 40) or
back polyester fibre filling
and 1x (35x50)
fabrics see page 166 - 167

COLOURS



FOSSIL GREY

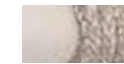

DUNE WHITE

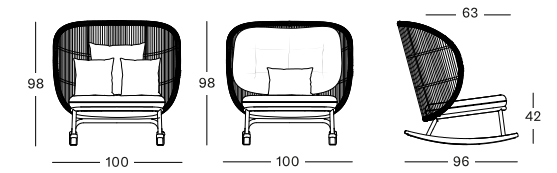

KODO SIDE TABLE

MATERIALS
powder coated aluminium
ceramic or aluminium top

DIMENSIONS
41 x 41 cm

COLOURS



**FOSSIL GREY
FLINT**

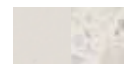

**DUNE WHITE
SHARDS**

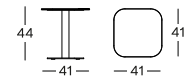

KODO SUNLOUNGER

MATERIALS
powder coated aluminium
polypropylene fibre

CUSHIONS
3 cm polyether foam filling
fabrics see page 166 - 167

COLOURS



FOSSIL GREY



DUNE WHITE

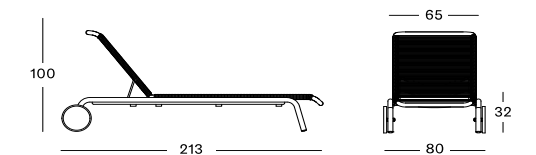

KODO DAYBED

MATERIALS
powder coated aluminium
polypropylene rope

CUSHIONS
seat 12 cm quick dry foam
back cushions 2x (60 x 60), 3x (50x50),
2x (40x40)
fabrics see page 166 - 167

COLOURS



FOSSIL GREY

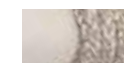

DUNE WHITE

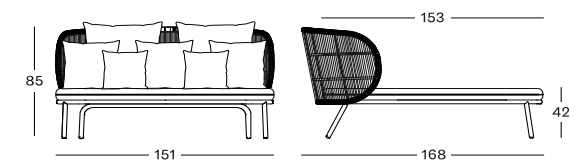



DAVID LOUNGE SOFA 2.5S, LOUNGE CHAIRS, COFFEE TABLE AND SIDE TABLE
TOUNDRA OUTDOOR RUG



DAVID DINING ARMCHAIRS AND DINING TABLE



DAVID LOUNGE CHAIR



LE CELTIQUE HÔTEL & SPA

CARNAC
FRANCE

Just a short stroll from Carnac's Grande Plage, which offers a splendid view over the islands of Houat and Belle-Île-en-Mer, you'll find Le Celtique & Spa, a top establishment in the seaside resort town since the 1920s when the town's first holidaymakers came.

The hotel currently comprises 53 rooms and suites, a restaurant, a bar, a heated indoor pool, a spa, and meeting rooms. All these spaces were the subject of a full and particularly careful restoration that started in spring 2020 and will soon be finished, aiming to bring the charm of this hotel so closely linked to the history of Carnac-Plage fully back to life.

The new decor brings together modernity and elegance in a subtle and enduringly attractive manner. The premises here blend in with the Art Deco spirit of the original building, which has been skilfully combined with maritime notes that help it embody the joy of the seaside.



DAVID LOUNGE CHAIR
VIVI SIDE TABLE
TIKA SMALL STEEL BASE



© CHRISTOPHE LE POTIER

DAVID LOUNGE CHAIR
VIVI SIDE TABLE



DAVID COFFEE & SIDE TABLES

MATERIALS
stained brushed teak
ceramic top

DIMENSIONS
side table: 40 x Ø 40 cm
coffee table: 34 x Ø 68 cm

COLOURS
aged teak / flint ceramic

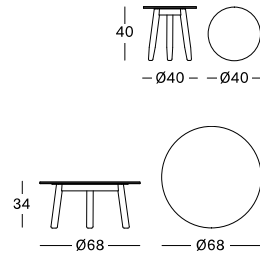

DAVID LOUNGE CHAIR

MATERIALS
stained brushed teak
polypropylene rope

CUSHIONS
seat 12 cm quick dry foam
back polyester fibre
fabrics see page 166 - 167

COLOURS
aged teak / greige

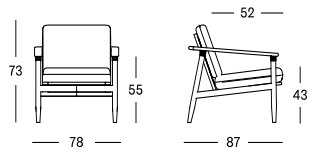

DAVID COFFEE & SIDE TABLES

MATERIALS
stained brushed teak
ceramic top

DIMENSIONS
side table: 41 x 41 cm
coffee table: 129 x 45 cm

COLOURS
aged teak / flint ceramic

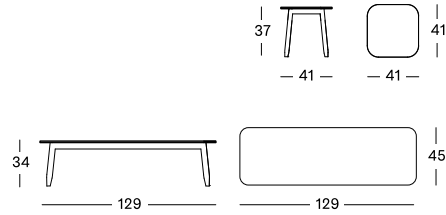

DAVID LOUNGE SOFA 2S

MATERIALS
stained brushed teak
polypropylene rope

CUSHIONS
seat 12 cm quick dry foam
back polyester fibre
fabrics see page 166 - 167

COLOURS
aged teak / greige

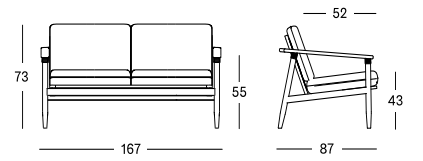

DAVID COFFEE TABLE 120X120

MATERIALS
stained brushed teak
ceramic top

DIMENSIONS
120 x 120 cm

COLOURS
aged teak / flint ceramic

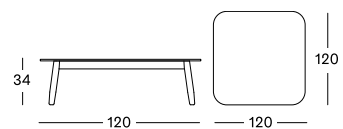

DAVID LOUNGE SOFA 3S

MATERIALS
stained brushed teak
polypropylene rope

CUSHIONS
seat 12 cm quick dry foam
back polyester fibre
fabrics see page 166 - 167

COLOURS
aged teak / greige

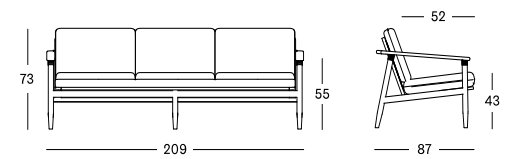



DAVID DINING ARMCHAIR



DAVID DINING ARMCHAIR

MATERIALS
stained brushed teak
polypropylene rope

CUSHION
4 cm quick dry foam
fabrics see page 166 - 167

COLOURS
aged teak / greige

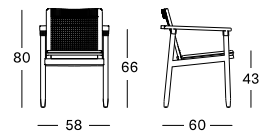

DAVID DINING TABLE

MATERIALS
stained brushed teak
ceramic top

DIMENSIONS
210 x 100 cm
280 x 106 cm

COLOURS
aged teak / flint ceramic

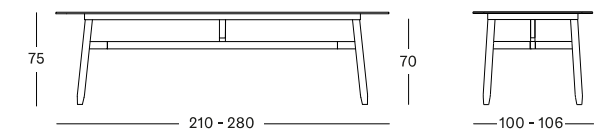

DAVID SUNLOUNGER

MATERIALS
stained brushed teak
polypropylene rope

CUSHION
6 cm quick dry foam
fabrics see page 166 - 167

COLOURS
aged teak / greige

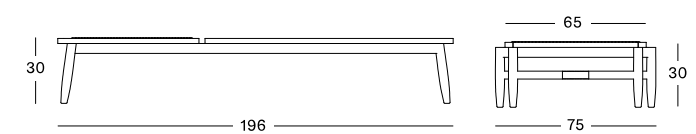



WICKED LOUNGE CHAIR, LOUNGE SOFA 3S, COFFEE AND SIDE TABLES



WICKED LOUNGE CHAIR, SOFA 2S
IVO SIDE TABLE
TIKA SMALL AND LARGE, TOUNDRA RUG



WICKED DINING TABLE AND CHAIRS



WICKED LOUNGE CHAIR

INTERCONTINENTAL RESORT

HAYMAN ISLAND
AUSTRALIA

Nestled at the northernmost point of Australia's Whitsunday archipelago, Hayman Island unlocks the heart of the Great Barrier Reef by placing you moments away from Langford Island, Bali Hai, Blue Pearl Bay and Hook Island, while gifting direct access to the region's icons through exclusive partnerships with Ocean Dynamics and Helireef.



ROY COCOON



© TIBERIO SORVILLO

WICKED LOUNGE CHAIR, LOUNGE SOFA, COFFEE AND SIDE TABLE



WICKED COFFEE TABLE

MATERIALS
powder coated aluminium
untreated teak

DIMENSIONS
123 x 55 cm

COLOURS

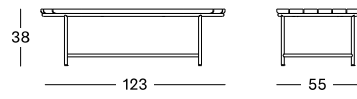
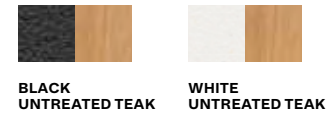

WICKED LOUNGE CHAIR

MATERIALS
powder coated aluminium
polyethylene wicker

CUSHIONS
seat 10 cm quick dry foam
deco 1 x (40x40)
fabrics see page 166 - 167

COLOURS

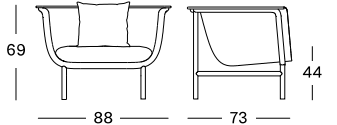

WICKED SIDE TABLE

MATERIALS
powder coated aluminium
untreated teak

DIMENSIONS
Ø 37 cm

COLOURS

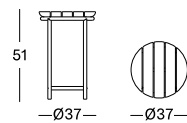

WICKED LOUNGE SOFA 2S

MATERIALS
powder coated aluminium
polyethylene wicker

CUSHIONS
seat 10 cm quick dry foam
deco 2x (45x50), 3x (40x40)
fabrics see page 166 - 167

COLOURS

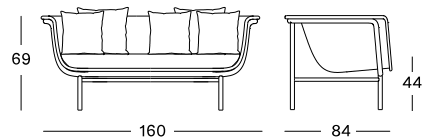

WICKED LOUNGE SOFA 3S

MATERIALS
powder coated aluminium
polyethylene wicker

CUSHIONS
seat 10 cm quick dry foam
deco 3x (45x50), 2x (40x40)
fabrics see page 166 - 167

COLOURS

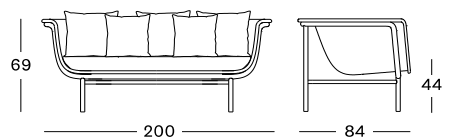



WICKED LOUNGE SOFA
COFFEE AND SIDE TABLE



WICKED DINING CHAIR

MATERIALS

powder coated aluminium
polyethylene wicker

CUSHIONS

2 cm polyether foam
fabrics see page 166 - 167

COLOURS

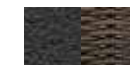

BLACK
TAUPE



BLACK
BLACK

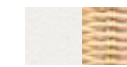

WHITE
NATURAL

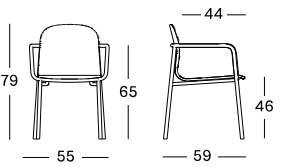

WICKED DINING TABLE

MATERIALS

powder coated aluminium
untreated teak

DIMENSIONS

200 x 90 cm
250 x 90 cm

COLOURS



BLACK
UNTREATED TEAK



WHITE
UNTREATED TEAK

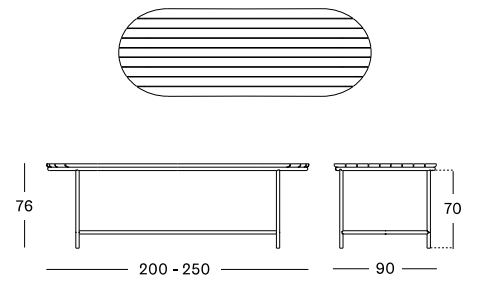

CASTEL

SOUTH TYROL
ITALY

Embedded in the impressive landscape of South Tyrol, hotel Castel welcomes their guests with personal service, spacious rooms with modern furnishings, a comprehensive range of wellness services and probably the best hotel catering in the region. Enjoy a unique stay, where, after you have arrived, you will feel like you have come home.

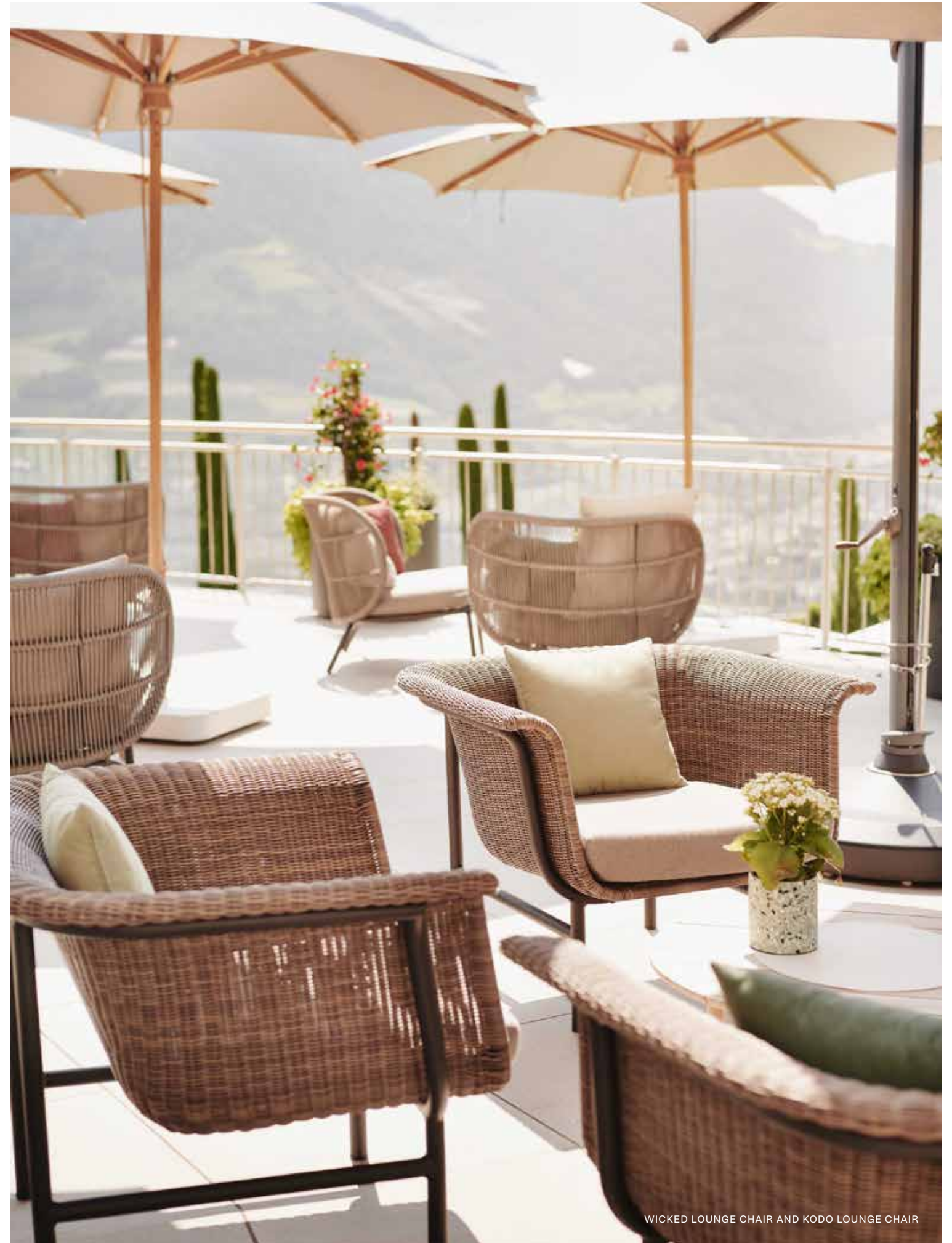

WICKED LOUNGE CHAIR AND KODO LOUNGE CHAIR

FRIDA



FRIDA LOUNGE CHAIR UNTREATED TEAK

MATERIALS
untreated teak
polypropylene rope

COLOURS
untreated teak / anthracite rope

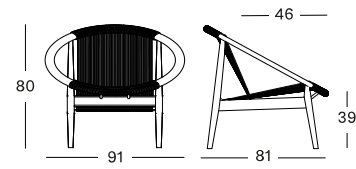

FRIDA LOUNGE CHAIR BLACK STAINED TEAK

MATERIALS
black stained teak
polypropylene rope

COLOURS
brushed teak black / onyx black rope

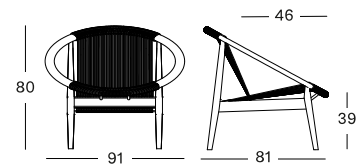

FRIDA LOUNGE CHAIR



FRIDA LOUNGE CHAIR

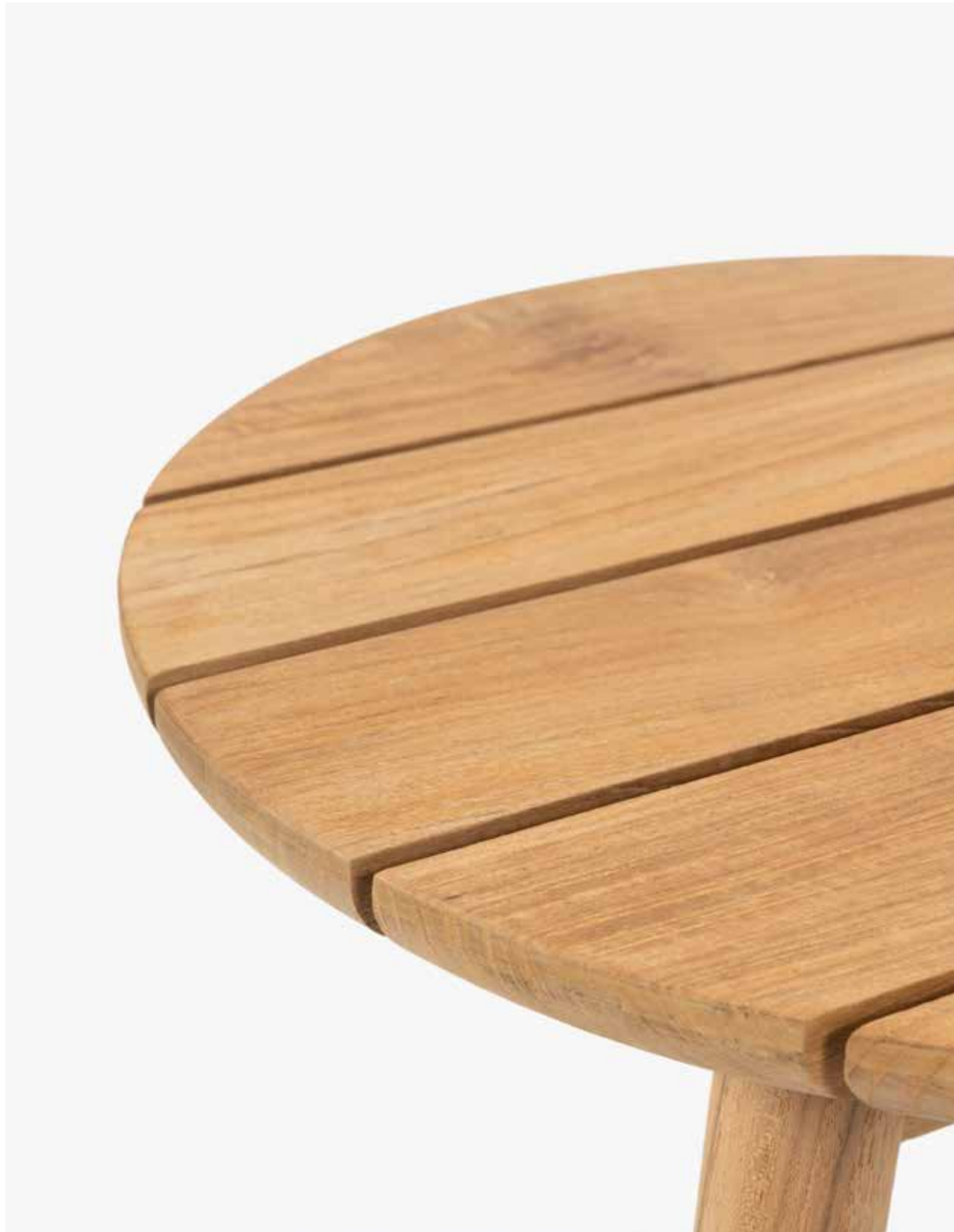

ANTON SIDE TABLE



ANTON SIDE TABLE TEAK 40

MATERIALS
untreated teak

DIMENSIONS
40,5 x Ø 40 cm

COLOURS
untreated teak

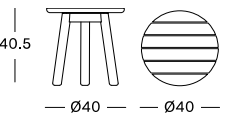

ANTON COFFEE TABLE TEAK 70

MATERIALS
untreated teak

DIMENSIONS
34,5 x Ø 70 cm

COLOURS
untreated teak

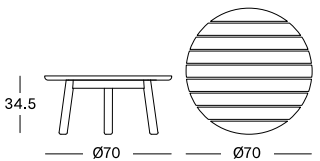

MORA

design by studio segers



MORA LAMP WITH HANDLE 54 CM H

MATERIALS

powder coated steel
polypropylene rope
solar-powered LED module

DIMENSIONS

54 cm H x Ø 26 cm

COLOURS

fossil grey

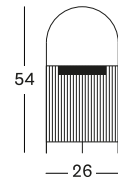

MORA LAMP 42 CM H X 54 CM DIA

MATERIALS

powder coated steel
polypropylene rope
solar-powered LED module

DIMENSIONS

42 cm H x Ø 54 cm

COLOURS

fossil grey

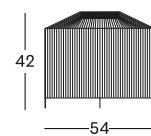

MORA LAMP 61 CM H X 40 CM DIA

MATERIALS

powder coated steel
polypropylene rope
solar-powered LED module

DIMENSIONS

61 cm H x Ø 40 cm

COLOURS

fossil grey

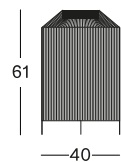

MORA LAMPS



TIKA LANTERN

MATERIALS
 powder coated aluminium
 HDPE wicker
 solar-powered LED module

DIMENSIONS
 40 x 35 cm
 59 x 47 cm

COLOURS
 black
 camel



TIKA LANTERN STEEL BASE

MATERIALS
 powder coated aluminium
 HDPE wicker
 solar-powered LED module

DIMENSIONS
 59 x 35 cm
 69 x 47 cm

COLOURS
 black steel / camel
 black steel / black

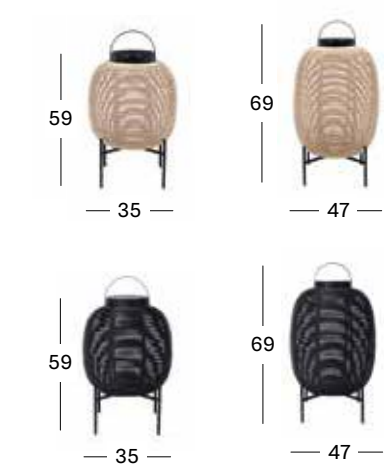

TIKA LANTERN TEAK BASE

MATERIALS
 powder coated aluminium
 HDPE wicker
 solar-powered LED module
 teak

DIMENSIONS
 59 x 35 cm
 69 x 47 cm

COLOURS
 teak / black





MATTEO DINING TABLE
EDGARD DINING CHAIR STEEL A BASE
LIGHT MY TABLE GARLAND



EDGARD BAR STOOL TEAK BASE

MATERIALS

aluminium and polyethylene wicker seat
teak base

COLOURS

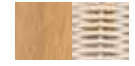

UNTREATED TEAK
OLD LACE

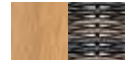

UNTREATED TEAK
MOCCA



UNTREATED TEAK
BLACK

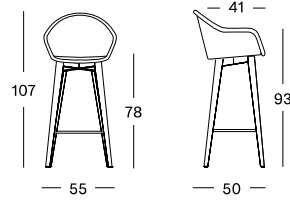

EDGARD DINING CHAIR TEAK BASE

MATERIALS

aluminium and polyethylene wicker seat
teak base

CUSHIONS

2 cm polyether foam
fabrics see page 166 - 167

COLOURS



UNTREATED TEAK
OLD LACE

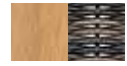

UNTREATED TEAK
MOCCA



UNTREATED TEAK
BLACK

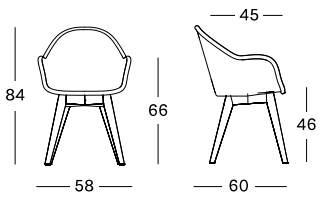

EDGARD BAR STOOL STEEL BASE

MATERIALS

aluminium and polyethylene wicker seat
black powder coated galvanized steel base

COLOURS

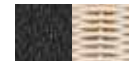

BLACK
OLD LACE



BLACK
MOCCA



BLACK
BLACK

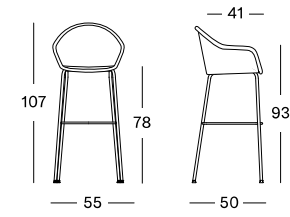

EDGARD DINING CHAIR STEEL A BASE

MATERIALS

aluminium and polyethylene wicker seat
black powder coated galvanized steel base

CUSHIONS

2 cm polyether foam
fabrics see page 166 - 167

COLOURS



BLACK
OLD LACE



BLACK
MOCCA



BLACK
BLACK

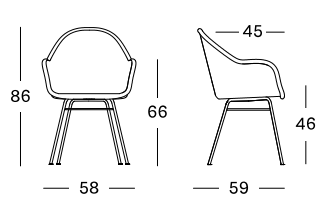

MATTEO DINING TABLE



MATTEO DINING TABLE

MATERIALS
black or white powder coated
aluminium legs
untreated teak top

DIMENSIONS
215 x 100 cm
285 x 100 cm

COLOURS



BLACK
UNTREATED TEAK

WHITE
UNTREATED TEAK

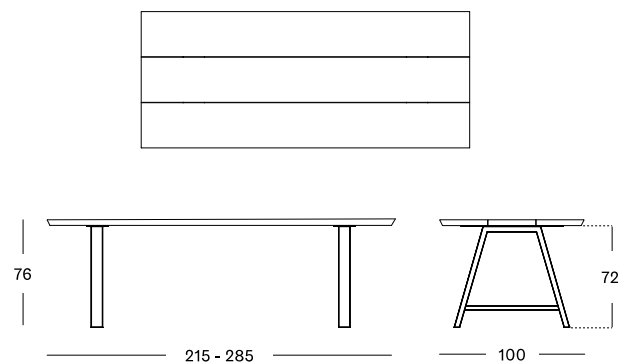

MATTEO BENCH

MATERIALS
black or white powder coated
aluminium legs
untreated teak seat

DIMENSIONS
195 x 40 cm
265 x 40 cm

COLOURS



BLACK
UNTREATED TEAK

WHITE
UNTREATED TEAK

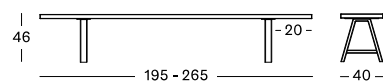

LIGHT MY TABLE

design by Studiomie

MATERIALS
black powder coated
galvanized steel
leather details
9 LED lamps 2W

DIMENSIONS
adjustable 200 – 300 cm
(for table tops up to 6 cm thick)

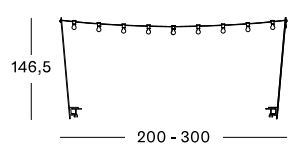

MATTEO DINING TABLE
EDGARD DINING CHAIR STEEL A BASE
LIGHT MY TABLE GARLAND

LENA



LENA DINING CHAIR TEAK BASE

MATERIALS

aluminium and polyethylene wicker seat
teak base

COLOURS



UNTREATED TEAK
OLD LACE

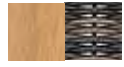

UNTREATED TEAK
MOCCA



UNTREATED TEAK
BLACK

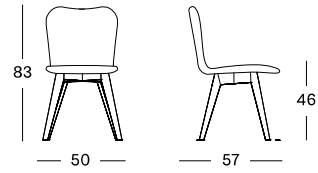

LENA DINING CHAIR STEEL A BASE

MATERIALS

aluminium and polyethylene wicker seat
black powder coated galvanized steel base

COLOURS



BLACK
OLD LACE



BLACK
MOCCA



BLACK
BLACK

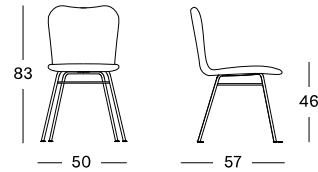

LENA DINING CHAIR TEAK BASE



LEO LOUNGE CHAIRS, LOUNGE SOFA, COFFEE TABLE AND SIDE TABLES



LEO DINING CHAIRS
AND DINING TABLE



LEO MODULAR CORNER RIGHT AND LEFT, MODULAR CENTER, MODULAR FOOTREST AND MODULAR COFFEE TABLE

RESIDENTIAL PROJECT

SANTANYI
MALLORCA

This residential villa has been entirely redesigned with respect for authentic materials and contrasting contemporary elements. The rooftop terrace provides a stunning view over the Mallorcan city centre while offering all comfort to enjoy wonderful moments outdoors.

Design by Marga Comas Interior Design





LEO SIDE TABLE DIA 45
LEO COFFEE TABLES DIA 60 – 70

MATERIALS
 powder coated aluminium

COLOURS
 lava

DIMENSIONS
 48 x Ø 45 cm
 32 x Ø 60 cm
 38 x Ø 70 cm

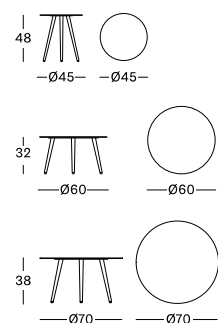

LEO DINING CHAIR

MATERIALS
 powder coated aluminium
 acrylic rope

CUSHIONS
 seat 4 cm quick dry foam
 back polyester fibre
 fabrics see page 166 - 167

COLOURS
 lava

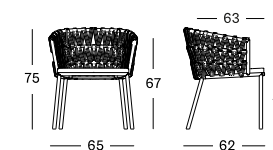

LEO DINING TABLE 90x90

MATERIALS
 powder coated aluminium
 untreated teak top

COLOURS
 lava / teak

DIMENSIONS
 90 x 90 cm

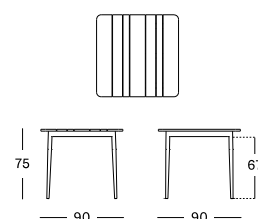

LEO LOUNGE CHAIR

MATERIALS
 powder coated aluminium
 acrylic rope

CUSHIONS
 seat 12 cm quick dry foam
 back polyester fibre
 fabrics see page 166 - 167

COLOURS
 lava

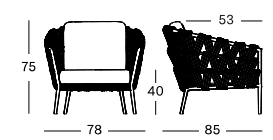

LEO DINING TABLE

MATERIALS
 powder coated aluminium
 untreated teak top

COLOURS
 lava / teak

DIMENSIONS
 180 x 90 cm
 240 x 100 cm

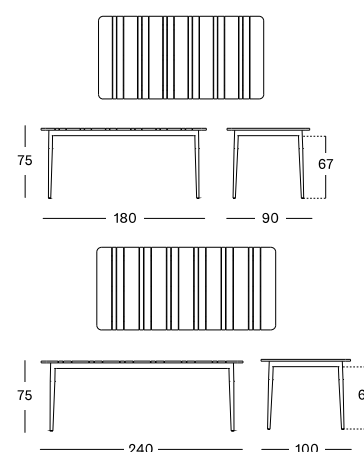

LEO LOUNGE SOFA

MATERIALS
 powder coated aluminium
 acrylic rope

CUSHIONS
 seat 12 cm quick dry foam
 back polyester fibre
 fabrics see page 166 - 167

COLOURS
 lava

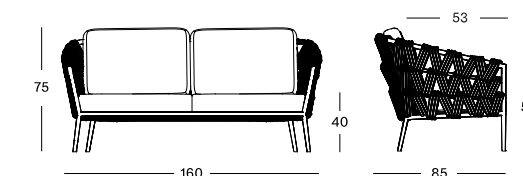

LEO MODULAR FOOTREST**MATERIALS**

powder coated aluminium

CUSHIONseat 12 cm quick dry foam
fabrics see page 166 - 167**COLOURS**

lava

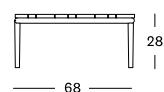
**LEO MODULAR CORNER LEFT****MATERIALS**powder coated aluminium
acrylic rope**CUSHIONS**seat 12 cm quick dry foam
back polyester fibre
deco 1x (50x50), 1x (40x40)
fabrics see page 166 - 167**COLOURS**

lava

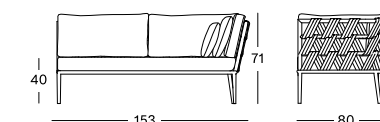
**LEO MODULAR COFFEE TABLE****MATERIALS**powder coated aluminium
untreated teak**DIMENSIONS**

68 x 68 cm

COLOURS

lava / teak

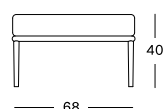
**LEO MODULAR CORNER RIGHT****MATERIALS**powder coated aluminium
acrylic rope**CUSHIONS**seat 12 cm quick dry foam
back polyester fibre
deco 1x (50x50), 1x (40x40)
fabrics see page 166 - 167**COLOURS**

lava

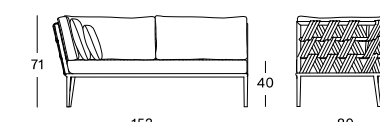
**LEO MODULAR CENTER****MATERIALS**powder coated aluminium
acrylic rope**CUSHIONS**seat 12 cm quick dry foam
back polyester fibre
fabrics see page 166 - 167**COLOURS**

lava

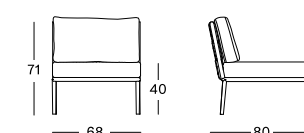



ROXY DINING CHAIR



ROXANNE LAZY CHAIR



LE CARL GUSTAF

SAINT-BARTH

A unique historic address nestled on a hillside overlooking the island, between Caribbean land and sea. The story of a vibrant and iconic 80s hotel that is reinventing itself and writing a new page in its legendary history, enhanced by the prestigious interior design firm Gilles & Boissier.

Like any home, the intimate Le Carl Gustaf offers 21 keys to its guests. Bungalows, suites, loft and villa. An elegant colonial house where you're doing more than just visiting, you're taking endless pleasure in making yourself at home.

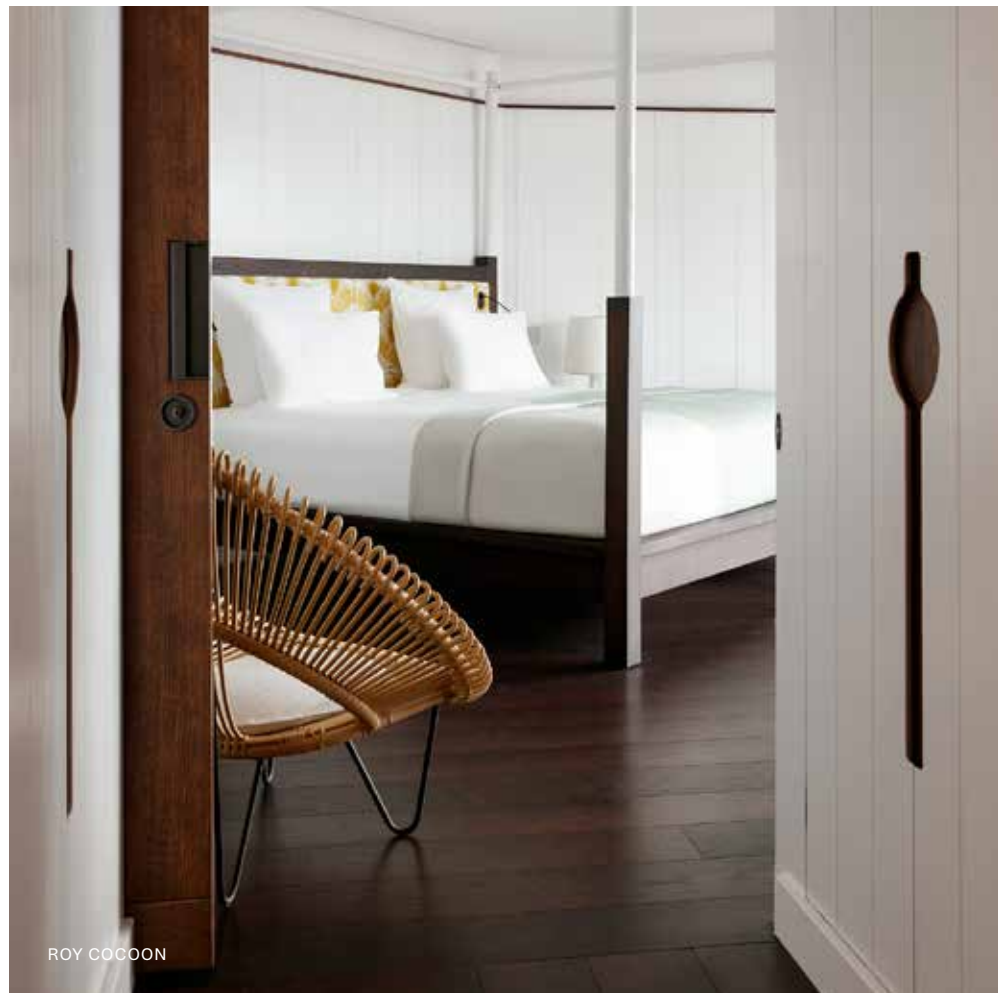



ROXANNE DINING CHAIR

MATERIALS

aluminium and polyethylene wicker seat
powder coated galvanized steel base

CUSHIONS

seat 2 cm polyether foam
fabrics see page 166 - 167

COLOURS



CAMEL
BLACK

BLACK
BLACK

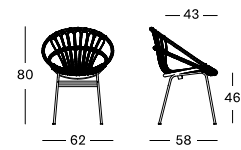

ROXY DINING CHAIR

MATERIALS

aluminium and polyethylene wicker seat
powder coated galvanized steel base

CUSHIONS

seat 2 cm polyether foam
fabrics see page 166 - 167

COLOURS



CAMEL
BLACK

BLACK
BLACK

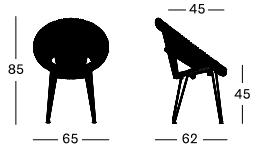

ROXANNE LAZY CHAIR

MATERIALS

aluminium and polyethylene wicker seat
powder coated galvanized steel base

CUSHIONS

seat 2 cm polyether foam
fabrics see page 166 - 167

COLOURS



CAMEL
BLACK

BLACK
BLACK

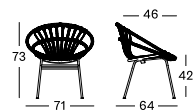

ROY LAZY CHAIR

MATERIALS

aluminium and polyethylene wicker seat
powder coated galvanized steel base

CUSHIONS

seat 2 cm polyether foam
fabrics see page 166 - 167

COLOURS



CAMEL
BLACK

BLACK
BLACK

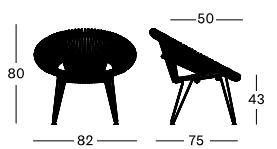

ROY COCOON

MATERIALS

aluminium and polyethylene wicker seat
powder coated galvanized steel base

CUSHIONS

seat 8 cm quick dry foam
fabrics see page 166 - 167

COLOURS



CAMEL
BLACK

BLACK
BLACK

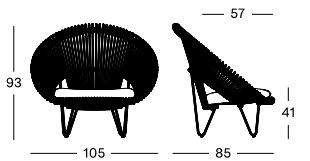

NOW COWORKING

MARSEILLE
FRANCE

Now Coworking is an original concept created by Pascal Givon and Edouard Laubies. They select atypical and premium sites in urban centres and transform them into innovative and creative workspaces. Their goal is to build an ecosystem capable of amplifying your projects by encouraging teamwork. Now Coworking Marseille is one of those innovative workspaces which combines a stunning location in the Vieux Port with top-notch facilities.



ROXANNE DINING CHAIR
CLARK BISTRO TABLE
EDGARD BAR STOOL
CLARK BISTRO TABLE HIGH
LOOP LOUNGE CHAIR
ROZY SIDE TABLE



LOOP LOUNGE CHAIR AND SIDE TABLE



LOOP DINING CHAIR



LOOP LOUNGE CHAIR, LOUNGE SOFA, AND COFFE TABLE
CLIFF OUTDOOR RUG



LOOP SUNLOUNGER



LOOP LOUNGE CHAIR
OTTO POUF

LE VIEUX LOGIS

TREMOLAT
FRANCE

Enter into this unique place full of charm and elegance. Le Vieux Logis, a historic Relais & Châteaux, member of the association since 1955, is a family house anchored in a former agricultural estate. Discover its mansion, the old farmhouse, the outbuildings and the gourmet restaurant located in the old tobacco drying shed.

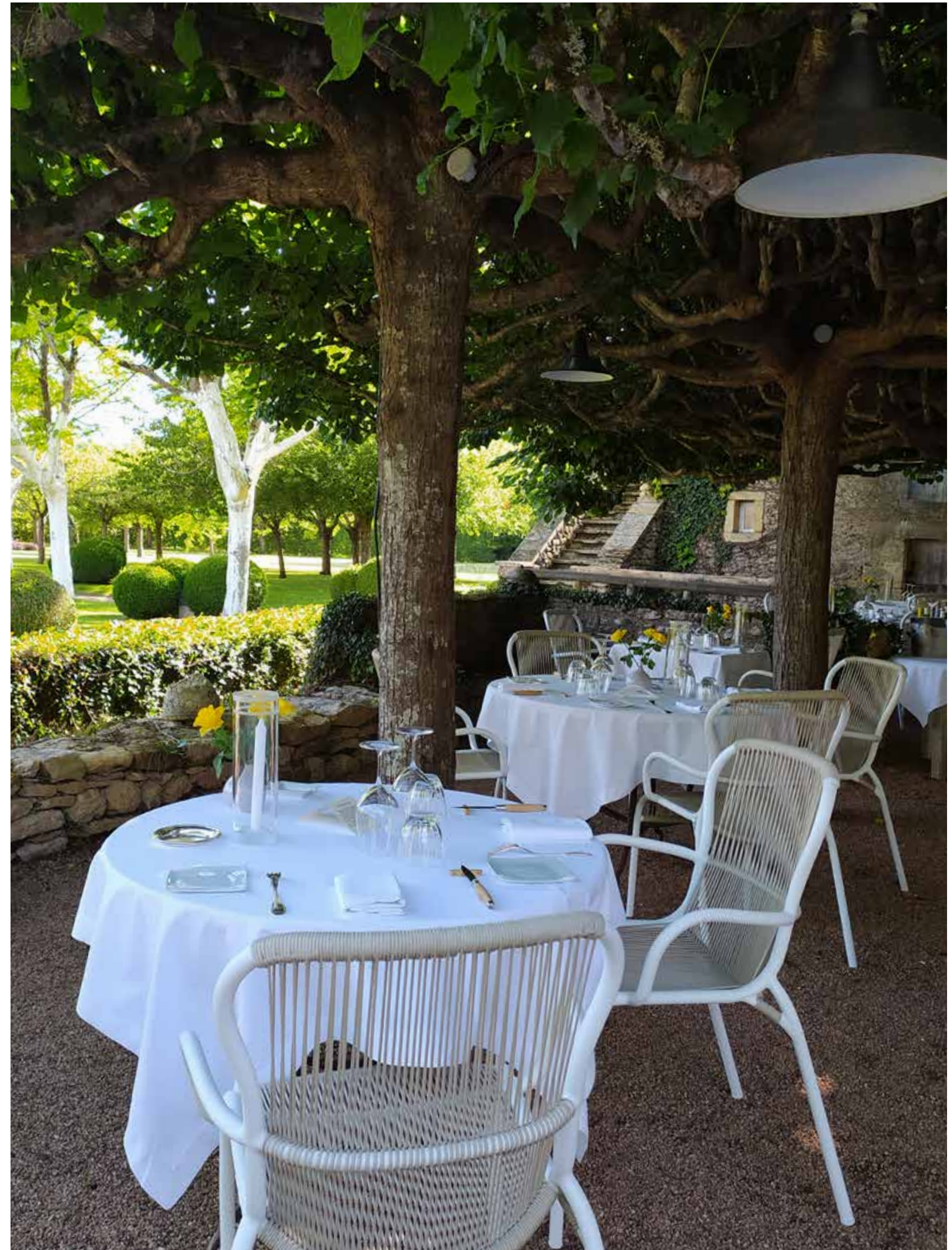



LOOP FOOTREST

MATERIALS
powder coated aluminium
polyethylene fibre (black) or
polypropylene rope (other colours)

COLOURS

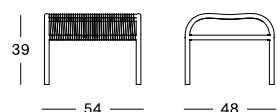

LOOP DINING CHAIR

MATERIALS
powder coated aluminium
polyethylene fibre (black) or
polypropylene rope (other colours)

COLOURS

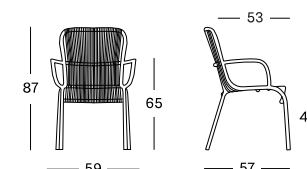

LOOP SIDE TABLE

MATERIALS
powder coated aluminium
polyethylene fibre (black) or
polypropylene rope (other colours)

COLOURS

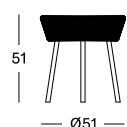

LOOP LOUNGE CHAIR

MATERIALS
powder coated aluminium
polyethylene fibre (black) or
polypropylene rope (other colours)

COLOURS

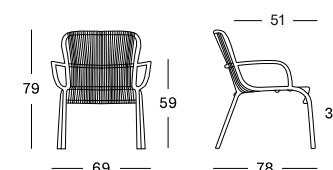

LOOP COFFEE TABLE

MATERIALS
powder coated aluminium
polyethylene fibre (black) or
polypropylene rope (other colours)

COLOURS

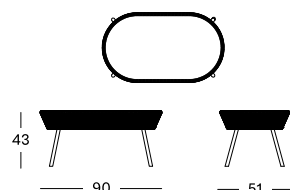
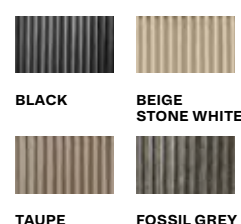

LOOP SOFA

MATERIALS
powder coated aluminium
polyethylene fibre (black) or
polypropylene rope (other colours)

COLOURS

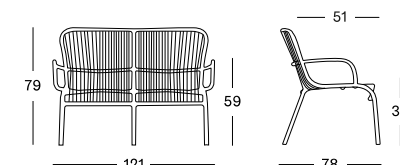
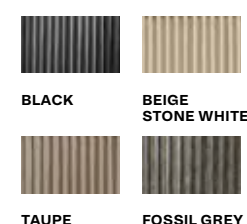



LOOP SUNLOUNGER

MATERIALS

powder coated aluminium
polyethylene fibre (black)
polypropylene rope (other colours)

CUSHIONS

3 cm polyether foam
fabrics see page 166 - 167

COLOURS



BLACK BEIGE STONE WHITE TAUPE FOSSIL GREY

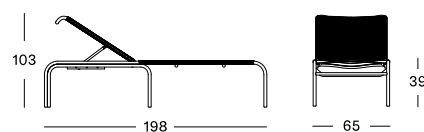

LOOP DINING TABLES

MATERIALS

powder coated aluminium
stained brushed teak

DIMENSIONS

180 x 90 cm
240 x 100 cm

COLOURS

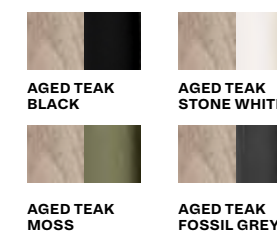

AGED TEAK BLACK AGED TEAK STONE WHITE

AGED TEAK MOSS AGED TEAK FOSSIL GREY

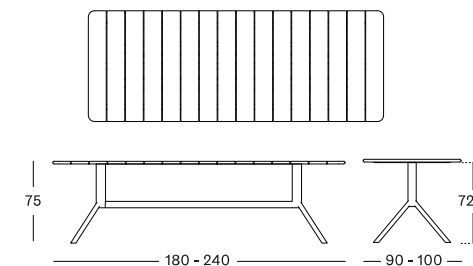

LOOP BISTRO TABLE DIA 80

MATERIALS

powder coated aluminium
stained brushed teak

DIMENSIONS

Ø 80 cm

COLOURS

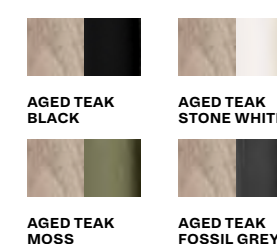

AGED TEAK BLACK AGED TEAK STONE WHITE

AGED TEAK MOSS AGED TEAK FOSSIL GREY

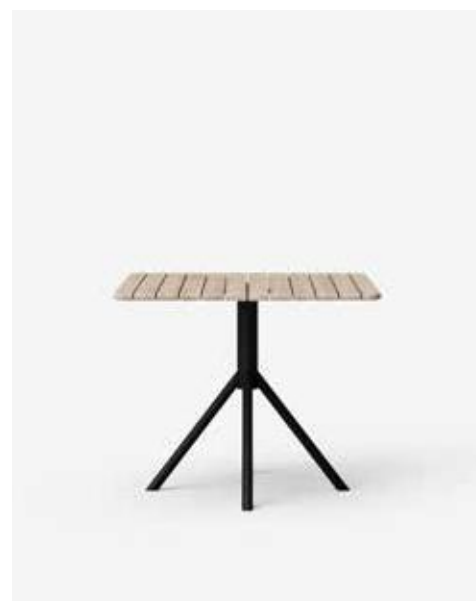
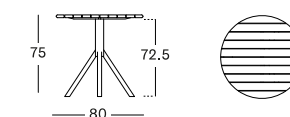

LOOP BISTRO TABLE 90

MATERIALS

powder coated aluminium
stained brushed teak

DIMENSIONS

90 x 90 cm

COLOURS

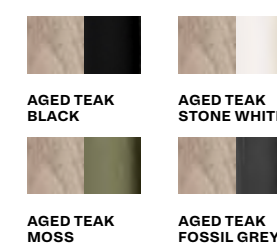

AGED TEAK BLACK AGED TEAK STONE WHITE

AGED TEAK MOSS AGED TEAK FOSSIL GREY

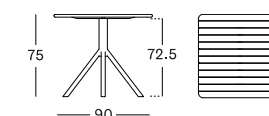



ROZY COFFEE & SIDE TABLE



ROZY SIDE TABLE

MATERIALS
powder coated galvanized steel
hpl

DIMENSIONS
50 x 49 x 42 cm

COLOURS
black

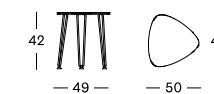

ROZY COFFEE TABLE

MATERIALS
powder coated galvanized steel
hpl

DIMENSIONS
99 x 114 x 72 cm

COLOURS
black

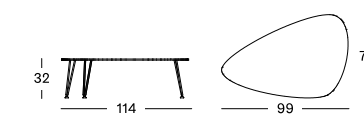



IVO SIDE TABLE DIA 44

MATERIALS
powder coated aluminium
HDPE wicker
hpl

COLOURS
black

DIMENSIONS
Ø 44 cm



IVO COFFEE TABLE DIA 77

MATERIALS
powder coated aluminium
HDPE wicker
hpl

COLOURS
black

DIMENSIONS
Ø 77 cm



IVO COFFEE TABLE DIA 93

MATERIALS
powder coated aluminium
HDPE wicker
hpl

COLOURS
black

DIMENSIONS
Ø 93 cm



IVO COFFEE AND SIDE TABLE

RUGS



TOUNDRA OUTDOOR RUG

MATERIALS
polyester fibre

DIMENSIONS
170 x 240 cm
200 x 300 cm
250 x 350 cm

COLOURS



SAHARA



SUNSET



MIST



CLIFF OUTDOOR RUG

MATERIALS
polyester fibre

DIMENSIONS
170 x 240 cm
200 x 300 cm
250 x 350 cm

COLOURS



CLAY



CLIFF RUG



IVO PLANT STAND SMALL

MATERIALS
powder coated aluminium
HDPE wicker
plastic saucer

DIMENSIONS
Ø 29 x 36 cm

COLOURS
black

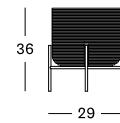

IVO PLANT STAND MEDIUM

MATERIALS
powder coated aluminium
HDPE wicker
plastic saucer

DIMENSIONS
Ø 40 x 45 cm

COLOURS
black

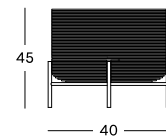

IVO PLANT STAND LARGE

MATERIALS
powder coated aluminium
HDPE wicker
plastic saucer

DIMENSIONS
Ø 29 x 65 cm

COLOURS
black

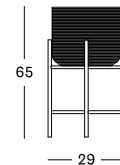

IVO PLANT STANDS



LUCY MODULAR SOFA SET, COFFEE TABLE AND LOUNGE CHAIR

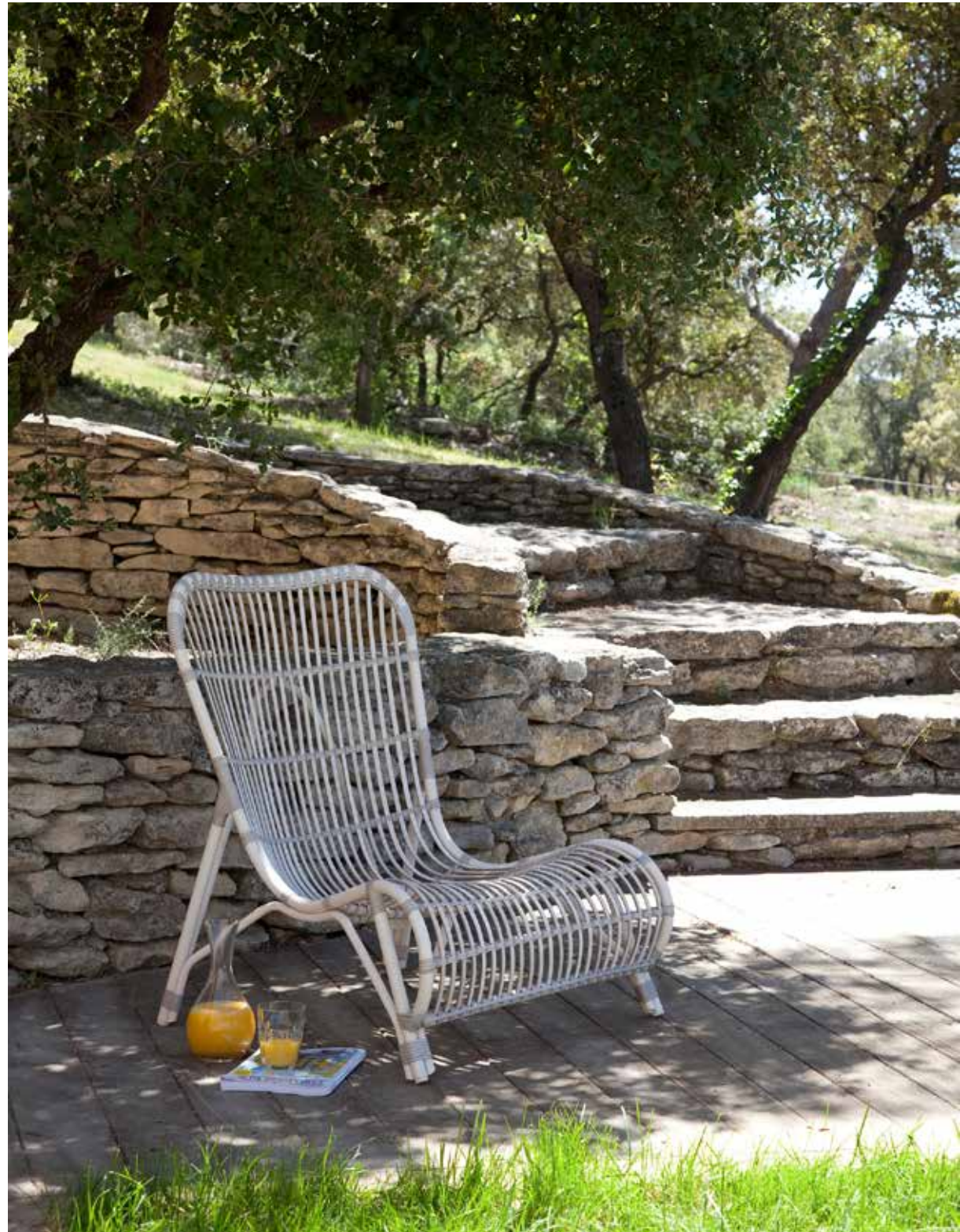

LUCY LOUNGE CHAIR



LUCY LAZY ARMCHAIR AND FOOTREST

LES SOURCES DE CAUDALIE

MARTILLAC
FRANCE

Located amidst the vineyards of Château Smith Haut Lafitte, Les Sources de Caudalie has been welcoming guests since 1999. Their philosophy is to use the natural richness of the vine, the grape, the land and the region to offer a unique experience in complete harmony with the environment.



LUCY LAZY ARMCHAIR AND FOOTREST

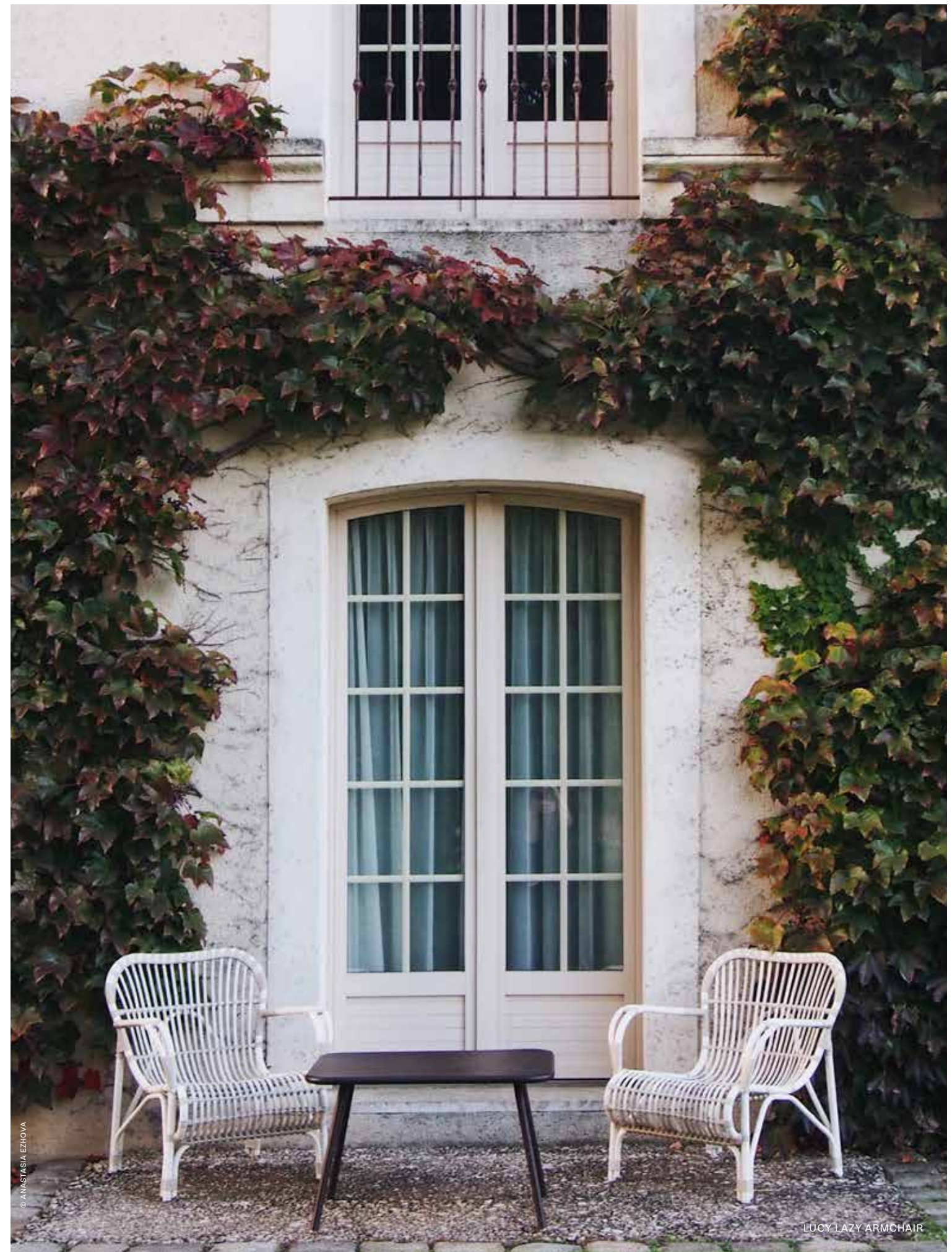

© ANASTASIA EZHOVA

LUCY LAZY ARMCHAIR



LUCY LOUNGE CHAIR

MATERIALS
powder coated aluminium
polyethylene fibre

CUSHION
seat 2 cm polyether foam
fabrics see page 166 - 167

COLOUR
off white

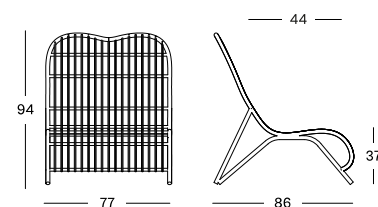

LUCY DINING CHAIR

MATERIALS
powder coated aluminium
polyethylene fibre

CUSHION
seat 2 cm polyether foam
fabrics see page 166 - 167

COLOUR
off white

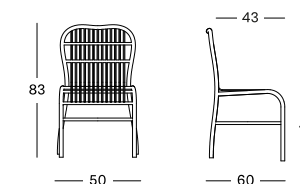

LUCY FOOTREST

MATERIALS
powder coated aluminium
polyethylene fibre

COLOUR
off white



LUCY DINING ARMCHAIR

MATERIALS
powder coated aluminium
polyethylene fibre

CUSHION
seat 2 cm polyether foam
fabrics see page 166 - 167

COLOUR
off white

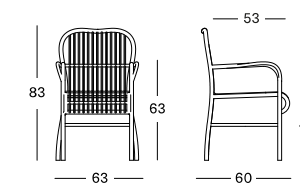

LUCY SUNLOUNGER

MATERIALS
powder coated aluminium
polyethylene fibre

CUSHION
seat 3 cm polyether foam
fabrics see page 166 - 167

COLOUR
off white

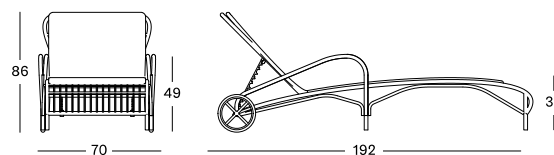

LUCY LAZY ARMCHAIR

MATERIALS
powder coated aluminium
polyethylene fibre

CUSHION
seat 2 cm polyether foam
fabrics see page 166 - 167

COLOUR
off white

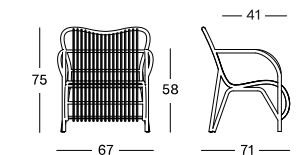



LUCY SIDE TABLE

MATERIALS
 powder coated aluminium
 polyethylene fibre
 glass

DIMENSIONS
 46 x 46 cm

COLOURS
 off white

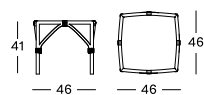

LUCY MODULAR CORNER

MATERIALS
 powder coated aluminium
 polyethylene fibre

CUSHIONS
 seat 12 cm quick dry foam
 back polyester fibre
 fabrics see page 166 - 167

COLOURS
 off white

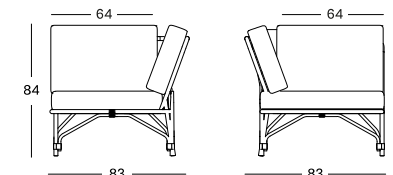

LUCY MODULAR COFFEE TABLE

MATERIALS
 powder coated aluminium
 polyethylene fibre
 glass

DIMENSIONS
 75 x 75 cm

COLOURS
 off white

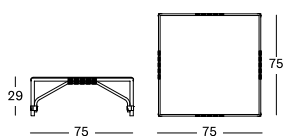

LUCY MODULAR CENTER

MATERIALS
 powder coated aluminium
 polyethylene fibre

CUSHIONS
 seat 12 cm quick dry foam
 back polyester fibre
 fabrics see page 166 - 167

COLOURS
 off white

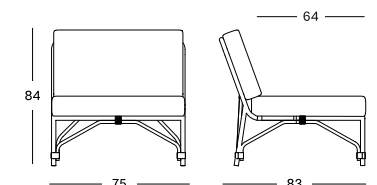

LUCY OTTOMAN

MATERIALS
 powder coated aluminium
 polyethylene fibre

CUSHIONS
 seat 12 cm quick dry foam
 fabrics see page 166 - 167

COLOURS
 off white

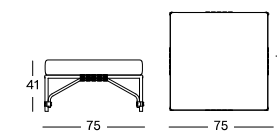



MAX DINING TABLE AND MONA DINING CHAIR



MONA DINING CHAIR TEAK

MATERIALS
polyethylene wicker seat
teak base

COLOUR
untreated teak / old lace

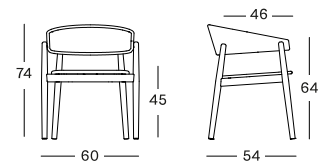

**MONA DINING CHAIR
BRUSHED TEAK BLACK**

MATERIALS
polyethylene wicker seat
teak base

COLOUR
brushed teak black / black

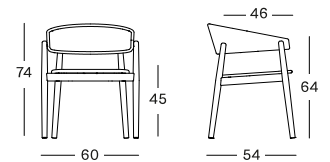

BISTRO TABLES

QUADRO BISTRO TABLE

MATERIALS
black powder coated steel base
untreated teak or hpl top

DIMENSIONS
70 x 70 cm

COLOURS

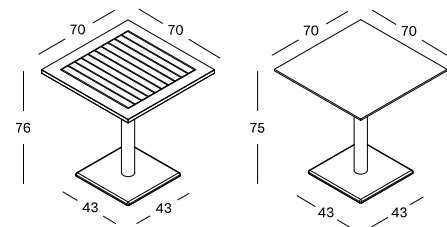
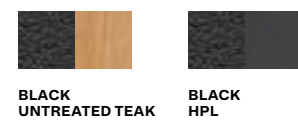

MAX DINING TABLE

MATERIALS
black powder coated aluminium frame
top untreated teak

DIMENSIONS
180 x 90 cm
240 x 100 cm

COLOURS
black / teak

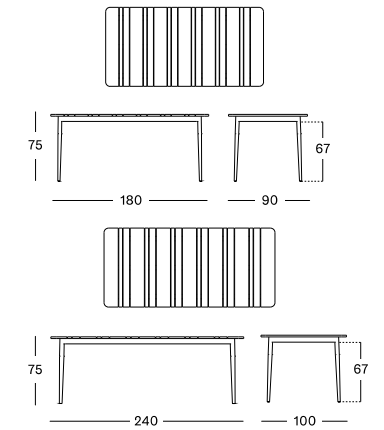

SPHERA BISTRO TABLE

MATERIALS
black powder coated steel base
untreated teak or hpl top

DIMENSIONS
Ø 80 cm

COLOURS

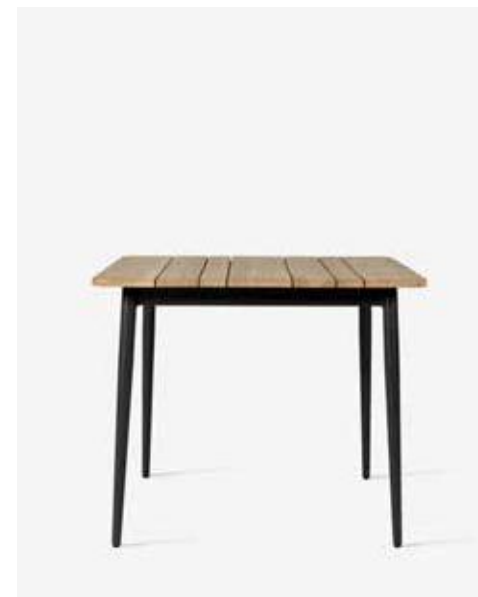
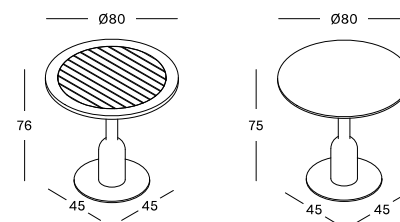
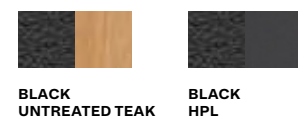

MAX DINING TABLE 90

MATERIALS
black powder coated aluminium frame
untreated teak or black hpl top

DIMENSIONS
90 x 90 cm

COLOURS

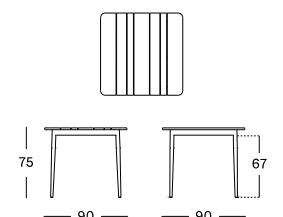
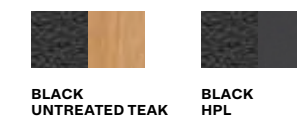

RONDA BISTRO TABLE

MATERIALS
black powder coated steel base
untreated teak or hpl top

DIMENSIONS
Ø 110 cm

COLOURS

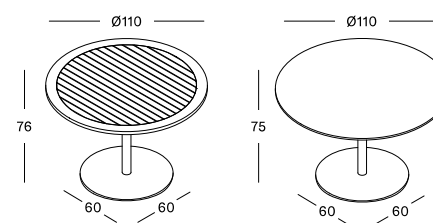
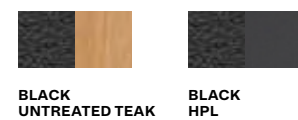

MIA & KENZO



MIA DINING CHAIR

MATERIALS
aluminium frame
polyethylene wicker

CUSHIONS
4 cm polyether foam
fabrics see page 166 - 167

COLOURS

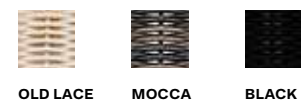

OLD LACE MOCCA BLACK

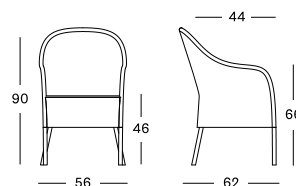

KENZO DINING CHAIR

MATERIALS
aluminium frame
polyethylene wicker

CUSHIONS
4 cm polyether foam
fabrics see page 166 - 167

COLOURS

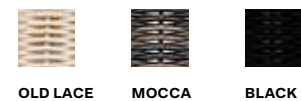

OLD LACE MOCCA BLACK

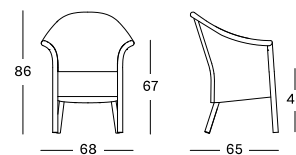

KENZO DINING CHAIRS



GIPSY DINING CHAIR
WICKED DINING TABLE



GIPSY LOUNGE AND OTTO POUFFE



GIPSY DINING CHAIR



GIPSY DINING CHAIR

MATERIALS

aluminium and polyethylene wicker seat
316 stainless steel or galvanized powder coated steel base

CUSHIONS

2 cm polyether foam
fabrics see page 166 - 167

COLOURS

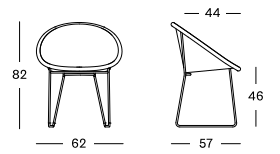
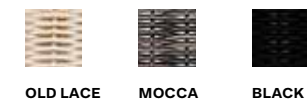

GIPSY COCOON

MATERIALS

aluminium and polyethylene wicker seat
316 stainless steel or galvanized powder coated steel base

CUSHIONS

8 cm quick dry foam
fabrics see page 166 - 167

COLOURS

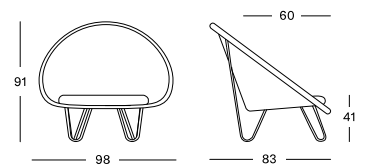
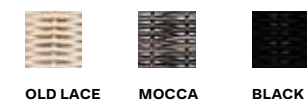

GIPSY LOUNGE

MATERIALS

aluminium and polyethylene wicker seat
316 stainless steel or galvanized powder coated steel base

CUSHIONS

seat 12 cm quick dry foam
back 1 x (60x60) and 2 x (40x40)
fabrics see page 166 - 167

COLOURS

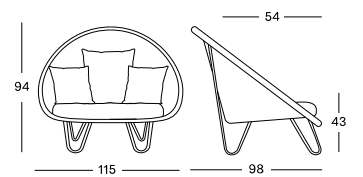
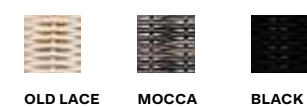

DECO CUSHIONS



DECO CUSHION

DIMENSION
60 x 60 cm

FABRICS
see page 166 - 167



DECO CUSHION

DIMENSION
50 x 50 cm

FABRICS
see page 166 - 167



DECO CUSHION

DIMENSION
45 x 50 cm

FABRICS
see page 166 - 167



DECO CUSHION

DIMENSION
40 x 40 cm

FABRICS
see page 166 - 167



DECO CUSHION

DIMENSION
35 x 50 cm

FABRICS
see page 166 - 167

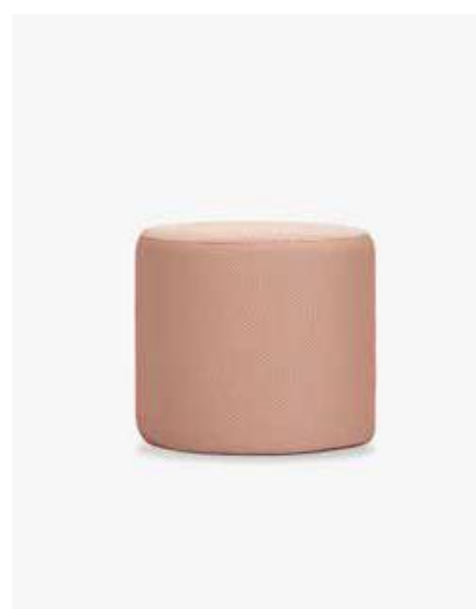

OLAF DIA 50

MATERIALS
breathable polyester
polystyrene beads

DIMENSIONS
Ø 50 x 40 cm

COLOURS
quick ship or com fabric

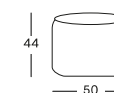

OLAF DIA 80

MATERIALS
breathable polyester
polystyrene beads

DIMENSIONS
Ø 80 x 40 cm

COLOURS
Quick ship or com fabric

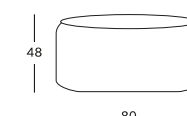

OTTO

MATERIALS
breathable polyester
polystyrene beads

DIMENSIONS
Ø 52 x 42 cm

COLOURS

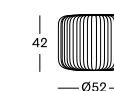





SAFI DINING TABLE AND DINING ARMCHAIR

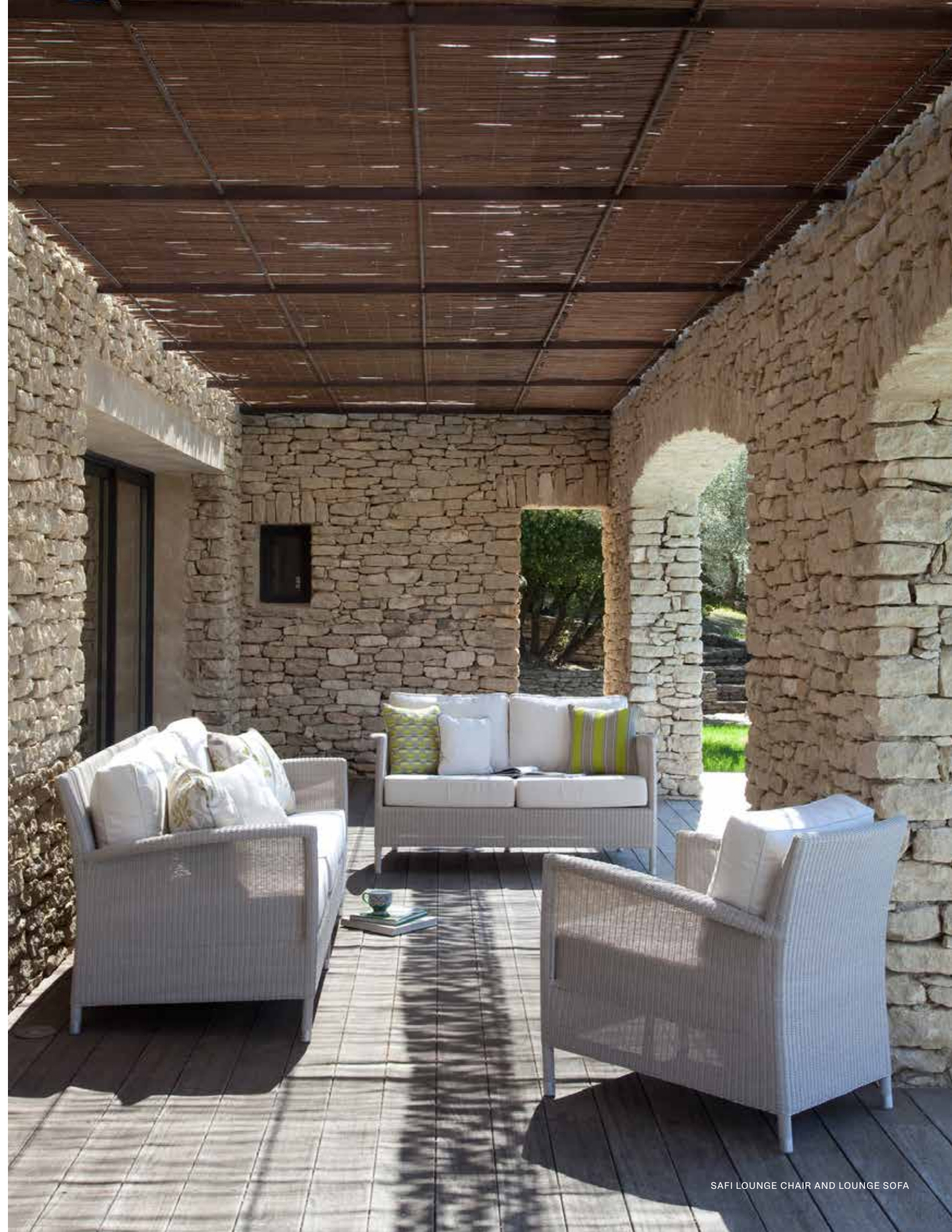

SAFI LOUNGE CHAIR AND LOUNGE SOFA

VILLA FIORENTINA

MALTA

Villa Fiorentina is an impressive residential villa located in Malta. The building is an ode to high-end natural materials such as marble and travertine stone which complement our tactile woven furniture. Large windows submerge the rooms with light and create an open and inviting atmosphere. In the extensive garden, Safi sunloungers are placed alongside the large swimming pool which breathe timeless elegance.

Design by Camilleriparismode

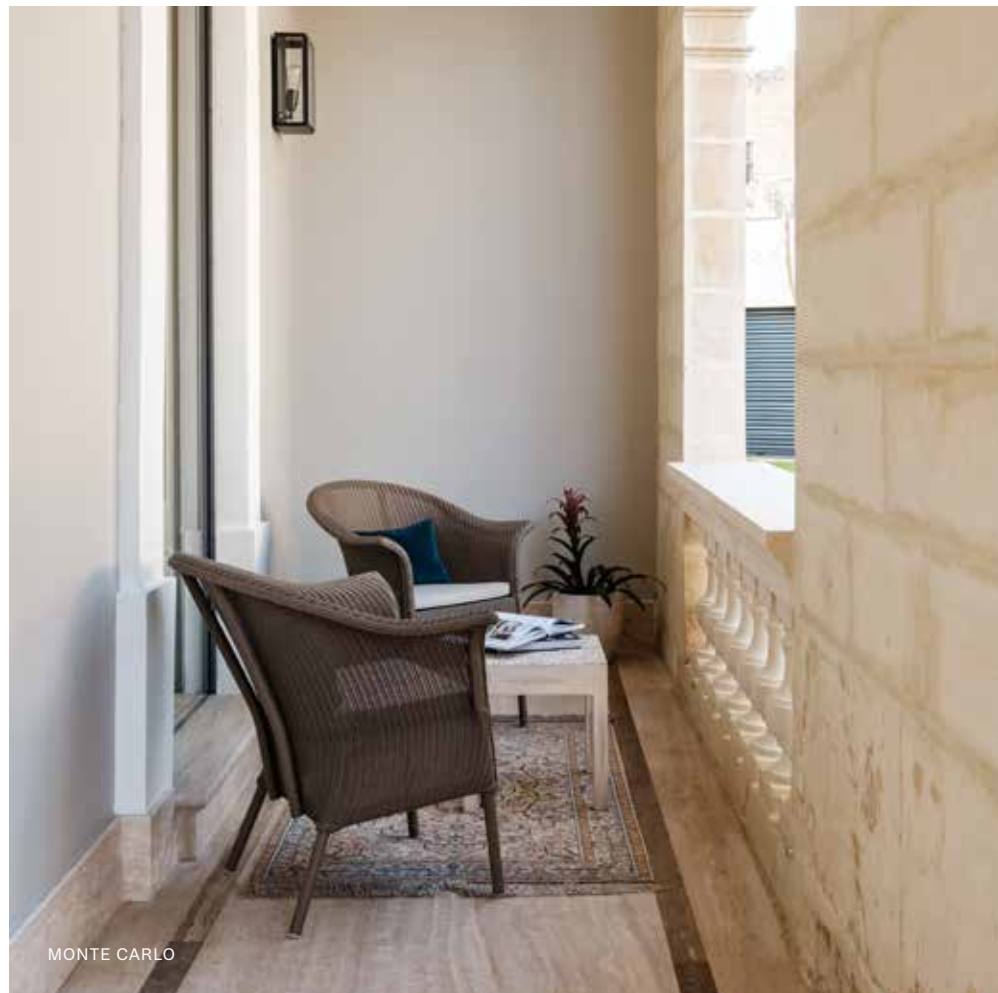



SAFI SUNLOUNGER WITH ARMS



SAFI SUNLOUNGER

MATERIALS
powder coated aluminium frame
polyethylene fibre

CUSHION
3 cm polyether foam
fabrics see page 166 - 167

COLOURS

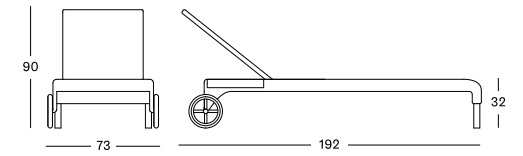

SAFI SUNLOUNGER WITH ARMS

MATERIALS
powder coated aluminium frame
polyethylene fibre

CUSHION
3 cm polyether foam
fabrics see page 166 - 167

COLOURS

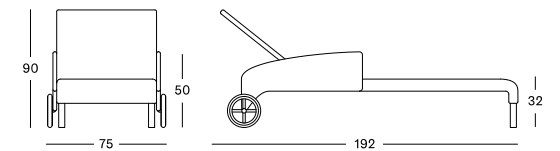

SAFI SIDE TABLE

MATERIALS
powder coated aluminium frame
polyethylene fibre
glass (optional)

DIMENSIONS
60 x 60 cm

COLOURS

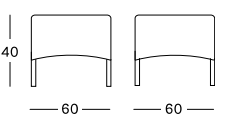



SAFI DINING CHAIR

MATERIALS
powder coated aluminium frame
polyethylene fibre

CUSHION
4 cm polyether foam
fabrics see page 166 - 167

COLOUR
old lace

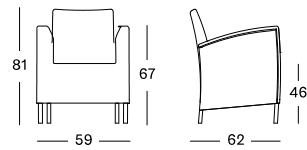

SAFI LOUNGE CHAIR

MATERIALS
powder coated aluminium frame
polyethylene fibre

CUSHION
seat 12 cm quick dry foam
back polyester fibre
fabrics see page 166 - 167

COLOUR
old lace

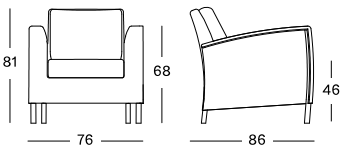

SAFI DINING TABLE DIA 120

MATERIALS
powder coated aluminium frame
polyethylene fibre
glass (optional)

DIMENSIONS
Ø 120 cm

COLOUR
old lace

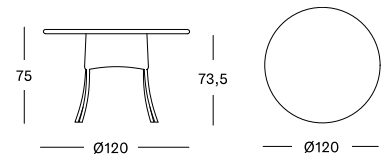

SAFI LOUNGE SOFA 2S

MATERIALS
powder coated aluminium frame
polyethylene fibre

CUSHION
seat 12 cm quick dry foam
back polyester fibre
fabrics see page 166 - 167

COLOUR
old lace

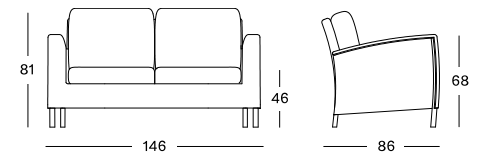

SAFI LOUNGE SOFA 3S

MATERIALS
powder coated aluminium frame
polyethylene fibre

CUSHION
seat 12 cm quick dry foam
back polyester fibre
fabrics see page 166 - 167

COLOUR
old lace

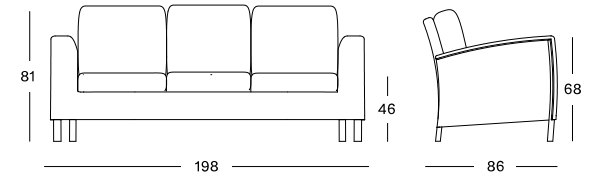

LLOYD LOOM COLLECTION

TREATED FOR OUTDOOR USE

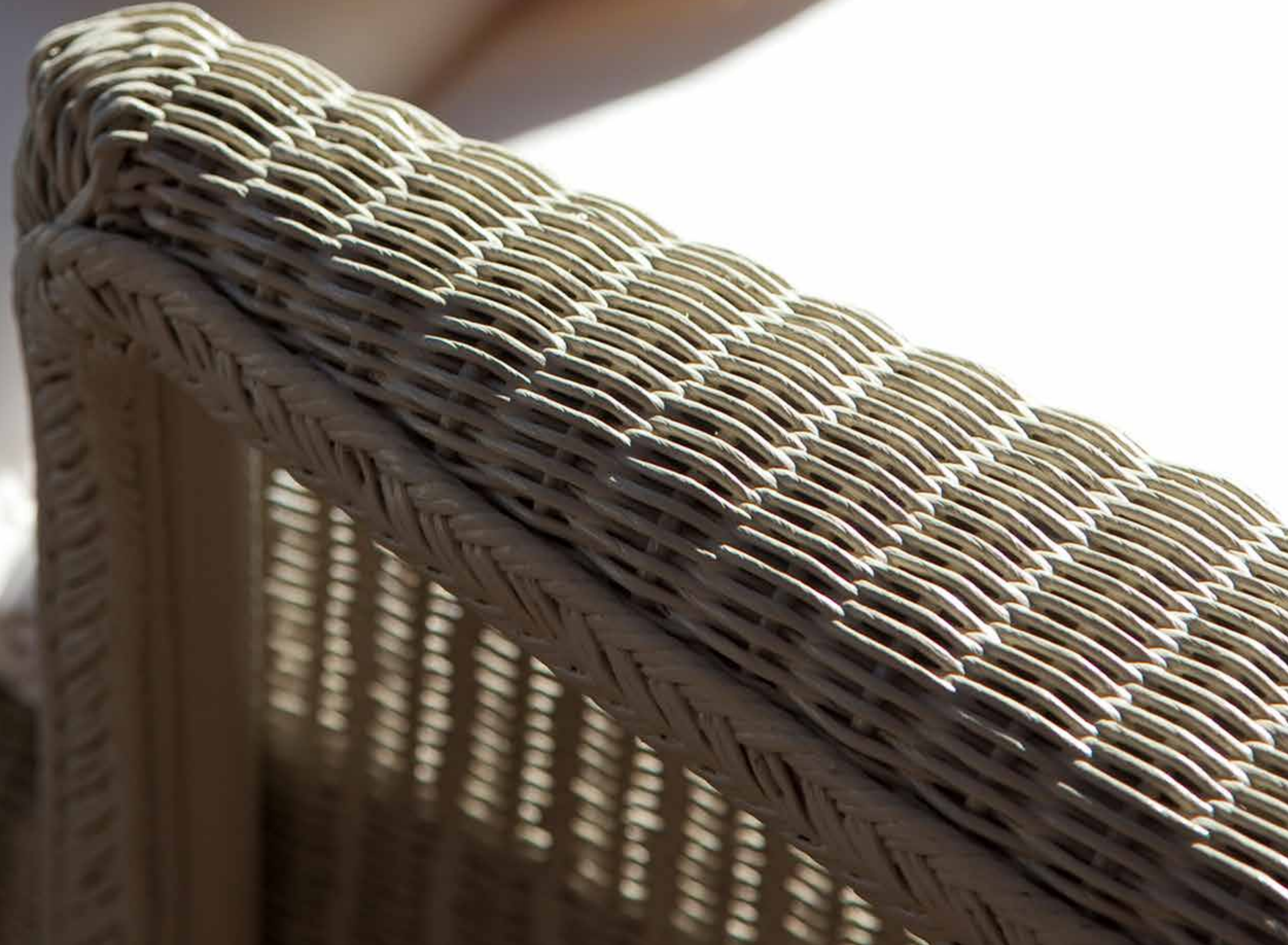



DOVILE DINING CHAIR



MONTE CARLO DINING CHAIR AND AVIGNON SIDE TABLE



DOVILE SUNLOUNGER



DOVILE DINING CHAIR

LA MAGDELEINE

GÉMENOS
FRANCE

With a history which stretches back more than two centuries, the boutique hotel of La Magdeleine has long been an iconic building in Gémenos. Its old stones, which have been worn over the years and are covered by climbing plants which create a beautifully elegant effect, have witnessed the comings and goings of generations of local residents, including Marcel Pagnol...

Young and old alike have taken a stroll in the vast grounds, leaving their mark on the terracotta floor tiles, marble and parquet floors. Beautiful centuries-old plane trees, changing colours with the passing seasons, have sheltered countless visitors for a day.

Simple and elegant, the property is intertwined with the history of Gémenos, in this stunning spot in Provence.



MONTE CARLO



MONTE CARLO



DOVILE DINING CHAIR

MATERIALS
powder coated aluminium frame
outdoor treated Lloyd Loom weave

CUSHION
seat 4 cm polyether foam
fabrics see page 166 - 167

COLOURS
see page 161

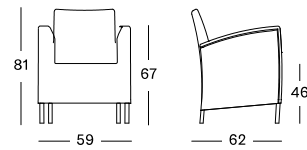

DOVILE LOUNGE CHAIR

MATERIALS
powder coated aluminium frame
outdoor treated Lloyd Loom weave

CUSHIONS
seat 12 cm high resilience foam
back polyester fibre
fabrics see page 166 - 167

COLOURS
see page 161

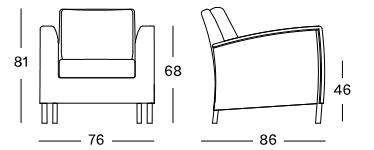

NIMES TABLE DIA 110 / 130

MATERIALS
powder coated aluminium frame
outdoor treated Lloyd Loom weave
glass (optional)

DIMENSIONS
Ø 110 cm
Ø 130 cm

COLOURS
see page 161

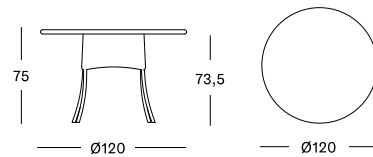

DOVILE LOUNGE SOFA 2S

MATERIALS
powder coated aluminium frame
outdoor treated Lloyd Loom weave

CUSHIONS
seat 12 cm high resilience foam
back polyester fibre
fabrics see page 166 - 167

COLOURS
see page 161

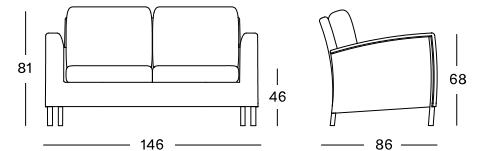

DOVILE FOOTREST

MATERIALS
powder coated aluminium frame
outdoor treated Lloyd Loom weave

CUSHIONS
seat 11 cm polyether foam
fabrics see page 166 - 167

COLOURS
see page 161

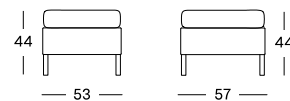

DOVILE LOUNGE SOFA 3S

MATERIALS
powder coated aluminium frame
outdoor treated Lloyd Loom weave

CUSHIONS
seat 12 cm high resilience foam
back polyester fibre
fabrics see page 166 - 167

COLOURS
see page 161

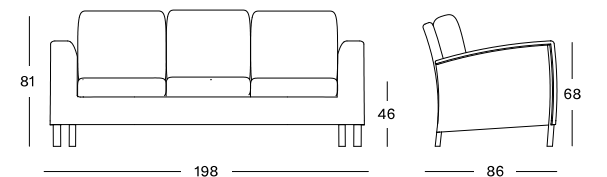



DOVILE SUNLOUNGER WITH ARMS

MATERIALS
powder coated aluminium frame
outdoor treated Lloyd Loom weave

CUSHION
seat 3 cm polyether foam
fabrics see page 166 - 167

COLOURS
see page 161

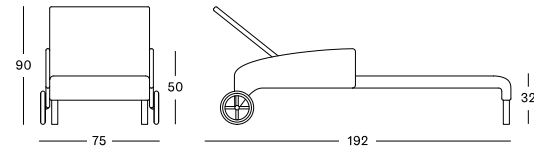

NICE DINING CHAIR

MATERIALS
powder coated aluminium frame
outdoor treated Lloyd Loom weave

CUSHION
seat 4 cm polyether foam
fabrics see page 166 - 167

COLOURS
see page 161

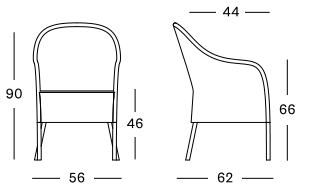

DOVILE SIDE TABLE

MATERIALS
powder coated aluminium
outdoor treated Lloyd Loom weave
glass (optional)

DIMENSIONS
60 x 60 cm

COLOURS
see page 161

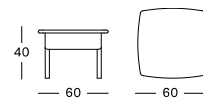

MONTE CARLO DINING CHAIR

MATERIALS
powder coated aluminium frame
outdoor treated Lloyd Loom weave

CUSHION
seat 4 cm polyether foam
fabrics see page 166 - 167

COLOURS
see page 161

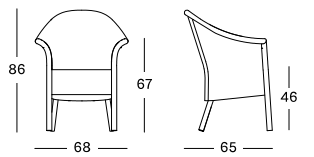

DOVILE COFFEE TABLE

MATERIALS
powder coated aluminium frame
outdoor treated Lloyd Loom weave
glass (optional)

DIMENSIONS
60 x 106 cm

COLOURS
see page 161

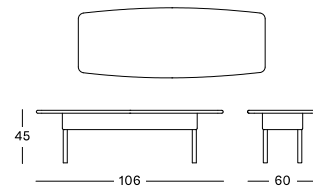

AVIGNON SIDE TABLE

MATERIALS
powder coated aluminium frame
outdoor treated Lloyd Loom weave
glass (optional)

DIMENSIONS
Ø 60 cm

COLOURS
see page 161

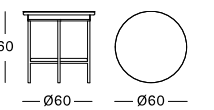



DOVILE SUNLOUNGER WITH ARMS

SOLID COLOURS

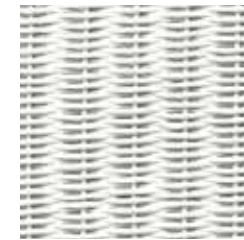

PURE WHITE
P024

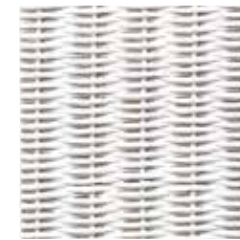

SNOW
P020

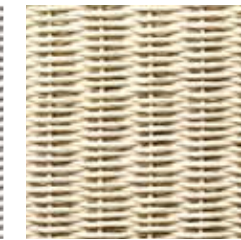

BROKEN WHITE
P026

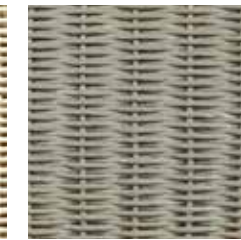

PEBBLE
P025

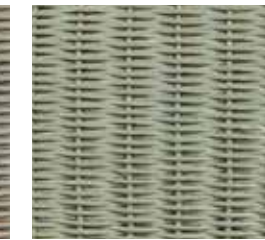

DUSTY GREEN
P050

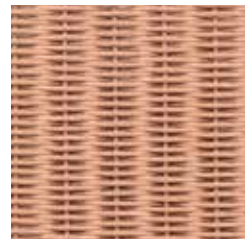

DUSTY CORAL
P034

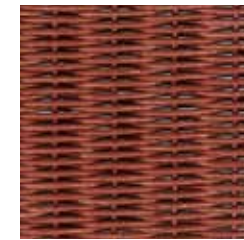

TERRACOTTA
P035

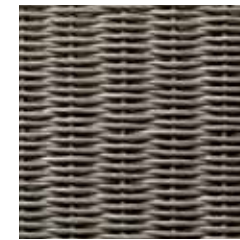

QUARTZ GREY
P086

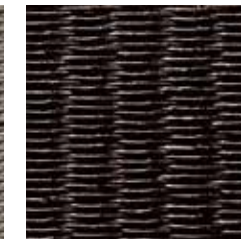

BLACK
P080

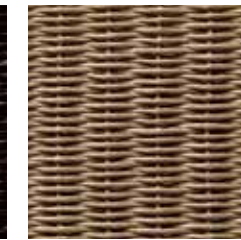

TAUPE
P084

METALLIC FINISH



SPARKLE
P033



NACR 
P023

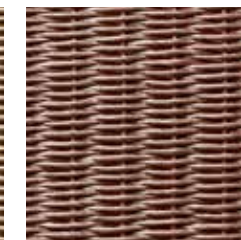

COPPER
P079

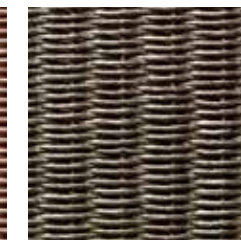

OYSTER
P036

TECHNICAL INFORMATION

MATERIALS
FABRICS

TEAK

Teak is a tropical hardwood which is known for its strength and durability. Our teak furniture is delivered untreated and will develop a beautiful silvery grey patina. Clean your table once a year with warm soapy water to discourage moss. If you wish to protect your furniture against stains, we recommend treating teak furniture with a teak sealant. As teak is a natural product, small cracks may develop over time.

ALUMINIUM

Aluminium is a light-weight material which is mainly used as an alternative for steel. Aluminium has a self-protective layer, which prevents corrosion and makes this material very suitable for outdoor applications. Our aluminium furniture is powder coated, which enables us to offer a wide variety of colours. On top of that, it is super easy to maintain. A quick wash with a non-foaming mild detergent every now and then is all it needs!

SYNTHETIC WEAVE

For our all-weather outdoor collection, we use multiple synthetic materials, including polyethylene, polypropylene, and HDPE wicker. All our synthetic materials are specifically designed to withstand any weather conditions, are UV-resistant, and can be left outside all year long. We recommend giving them a quick wash when dirty or every three months with a non-foaming mild detergent.

100% SOLUTION DYED ACRYLIC

- may be machine-washed at 40°C
- may be tumble dried
- may be ironed, ironing temperature should not be higher than 110°C
- the fabric may be treated with bleach
- may be dry cleaned

ACRYLIC ROPE

- may be machine-washed at 40°C
- may be tumble dried
- may be ironed, ironing temperature should not be higher than 110°C
- the fabric may be treated with bleach
- may be dry cleaned

POLYPROPYLENE ROPE

- may be machine-washed at 40°C
- may be tumble dried
- may be ironed, ironing temperature should not be higher than 110°C
- the fabric may not be treated with bleach
- do not dry clean



CERAMIC

Ceramic requires little to no maintenance, yet offers maximum resistance. The material preserves the natural look of stone and offers top of the chart convenience. Ceramic is scratchproof, UV-resistant, stainproof, and resistant to fire and high temperatures. Use pure water or a cleaning solution without soap for ceramic surfaces to clean the table. Please do not use soap.

OUTDOOR LOOM

Lloyd Loom weave is made from twisted Kraft paper on the one hand, and Kraft paper spun around a steel wire on the other hand. In order to be able to use Lloyd Loom for outside furniture as well, a specific technique was developed to make the material waterproof. Our outdoor Lloyd Loom models can thus simply be left outside, although we recommend storing them inside during cold or rainy periods.

CUSHIONS

From snuggling between soft pillows to enjoying a dinner party on a lovely dining chair with seat cushion. Comfortable cushions take your seating experience to the next level.

Vincent Sheppard uses high-quality materials and relies on advanced textile technologies to create its cushions. Our fabrics are water-repellent, breathable, and UV-proof. The cushion's cores consist of outdoor foam, enabling you to leave them outdoors during any weather condition. Still, we recommend storing your cushions for the winter or when not in use for long periods.

Nearly all our cushion covers are removable which makes them look brand-new after a wash. As every fabric has its own characteristics, different washing instructions apply.

100% POLYOLEFIN

- may be machine-washed at 40°C with extra care
- do not tumble dry
- may not be ironed
- may be treated with bleach
- do not dry clean

MIX OF MATERIALS

- may be machine-washed at 40°C with extra care
- do not tumble dry
- do not iron
- do not bleach
- do not dry clean

OUTDOOR HPL

HPL or high-pressure laminate is a very sturdy material which consists of different layers which are pressed together under a high temperature. As a result, the material is very durable and UV-resistant. HPL is used for our table tops and can be used indoors as well as outdoors. The table tops do not require any maintenance except for a quick wash every now and then.

STEEL

Steel is mainly used for the legs and frames of our furniture pieces. For the outdoor pieces, the steel is always galvanized and powder coated to make sure it is protected from all weather influences.

RUGS

Vincent Sheppard outdoor rugs are made of polyester fibres. The high-performance rugs are dirt and water-repellent, and are thus easy to maintain. Use a high-pressure water hose to clean spots and blot dry afterwards.



PROTECTIVE COVERS

In order to protect your furniture and keep maintenance minimal, we have developed special protective covers.

The covers are made of 100% polyurethane and have welded, not stitched seams. Consequently, the covers are 100% waterproof.

CAT. B CUSHION FABRICS

Item codes starting with CB or QB



CANVAS S0606
100% SOLUTION DYED ACRYLIC



LIN S1212
100% SOLUTION DYED ACRYLIC

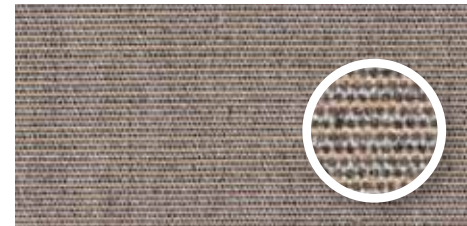

LONDON STONE S0808
100% SOLUTION DYED ACRYLIC

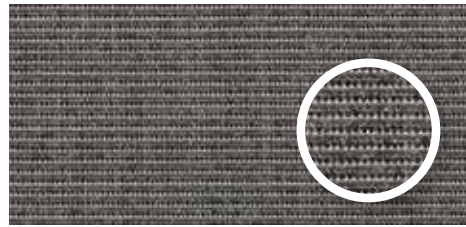

DARK SMOKE S0909
100% SOLUTION DYED ACRYLIC

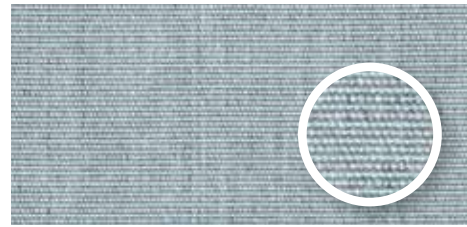

MINERAL BLUE S1010
100% SOLUTION DYED ACRYLIC



BLUSH S2929
100% SOLUTION DYED ACRYLIC



BLACK S1515
100% SOLUTION DYED ACRYLIC



OLIVE GREEN S2727
100% SOLUTION DYED ACRYLIC



CARBON BEIGE S2828
100% SOLUTION DYED ACRYLIC



AMBER S3030
100% SOLUTION DYED ACRYLIC

CAT. C CUSHION FABRICS

Item codes starting with CC or QC

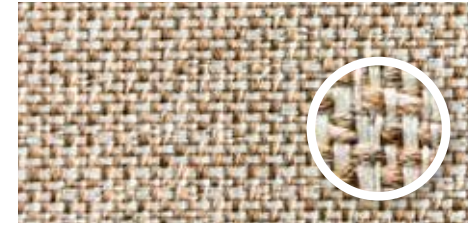

SAVANE COCONUT S2222
100% SOLUTION DYED ACRYLIC

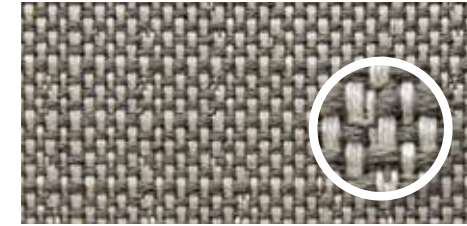

ZINC S2121
100% SOLUTION DYED ACRYLIC



SPICE P0202
100% POLYOLEFIN

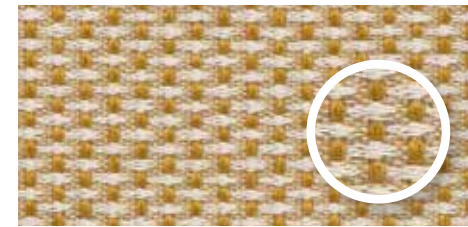

MUSTARD P0505
57% POLYOLEFIN / 43% POLYESTER

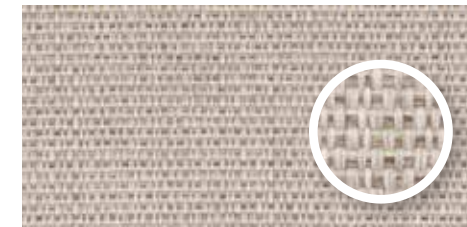

ALMOND P0303
100% POLYPROPYLENE

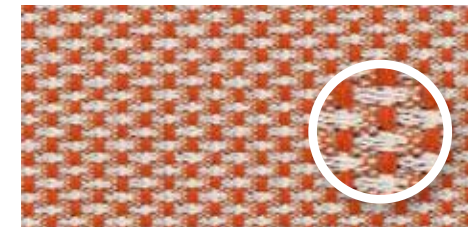

CORAL P0404
57% POLYOLEFIN / 43% POLYESTER

CAT. G CUSHION FABRICS

Item codes starting with CG or QG



KIWI P0707
100% POLYPROPYLENE



STONE T0202
100% SOLUTION DYED ACRYLIC

PRODUCT OVERVIEW

DINING CHAIRS
BAR STOOLS
LOUNGE CHAIRS
SOFAS
FOOTRESTS AND POUFFES
SUNLOUNGERS
TABLES AND BENCHES
COFFEE AND SIDE TABLES
ACCESSORIES

DINING CHAIRS



LOOP DINING CHAIR
P 105



GIPSY DINING CHAIR
P 135



DAVID DINING ARMCHAIR
P 43



KODO DINING CHAIR
P 028



EDGARD DINING CHAIR STEEL A BASE
P 71



EDGARD DINING CHAIR TEAK BASE
P 71



WICKED DINING CHAIR
P 55



LEO DINING CHAIR
P 83



LENA DINING CHAIR STEEL A BASE
P 74



LENA DINING CHAIR TEAK BASE
P 74



ROXANNE DINING CHAIR
P 92



ROXY DINING CHAIR
P 93

DINING CHAIRS



NICE DINING CHAIR LLOYD LOOM
P 159



DOVILE DINING CHAIR LLOYD LOOM
P 156



LUCY DINING CHAIR
P 123



LUCY DINING ARMCHAIR
P 123



MONTE CARLO DINING CHAIR LLOYD LOOM
P 159



MONA DINING CHAIR
P 127



SAFI DINING CHAIR SYNTHETIC
P 146

BAR STOOLS



EDGARD BAR STOOL TEAK BASE
P 70



EDGARD BAR STOOL STEEL BASE
P 70



MIA DINING CHAIR SYNTHETIC
P 130



KENZO DINING CHAIR SYNTHETIC
P 130

OTTOMANS AND POUFFES



OLAF POUFFE
P 137



OTTO POUFFE (AVAILABLE IN 5 COLOURS)
P 137



KODO FOOTREST
P 28



LOOP FOOTREST
P 104



LUCY FOOTREST
P 122



DOVILE FOOTREST LLOYD LOOM
P 156

LOUNGE CHAIRS



LENTO LOUNGE CHAIR
P 11



DAVID LOUNGE CHAIR
P 41



KODO ROCKING CHAIR
P 31



KODO COCOON
P 28



KODO LOUNGE CHAIR
P 29



WICKED LOUNGE CHAIR
P 53

LOUNGE CHAIRS



LUCY LOUNGE CHAIR & LAZY ARMCHAIR
P 122



LOOP LOUNGE CHAIR
P 105



LEO LOUNGE CHAIR
P 83



FRIDA LOUNGE CHAIR
P 58



DOVILE LOUNGE CHAIR LLOYD LOOM
P 157



SAFI LOUNGE CHAIR SYNTHETIC
P 147



ROY LAZY CHAIR
P 93



ROXANNE LAZY CHAIR
P 92



ROY COCOON
P 93

SOFAS



SAFI LOUNGE SOFA SYNTHETIC
P 147



GIPSY COCOON
P 135



GIPSY LOUNGE
P 135





DAVID LOUNGE SOFA 2S & 3S
P 41

LENTO LOUNGE SOFA 2.5S & 3S
P 11



KODO LOUNGE SOFA
P 29

KODO DAYBED
P 31

WICKED LOUNGE SOFA 2S & 3S
P 53



LEO LOUNGE SOFA
P 83

LOOP SOFA
P 105

DOVILE LOUNGE SOFA LLOYD LOOM
P 157

178

179

MODULAR SOFAS

MODULAR SOFAS



LEO MODULAR SET
P 85



LENTO MODULAR SET
P 12



LEO MODULAR CORNER RIGHT
P 85



LEO MODULAR CORNER LEFT
P 85



LENTO MODULAR CORNER LEFT
P 12



LENTO MODULAR CORNER RIGHT
P 12



LEO MODULAR CENTER
P 85



LEO MODULAR COFFEE TABLE
P 84



LEO MODULAR FOOTREST
P 84



LENTO CHAISE LONGUE RIGHT
P 13



LENTO CHAISE LONGUE LEFT
P 13

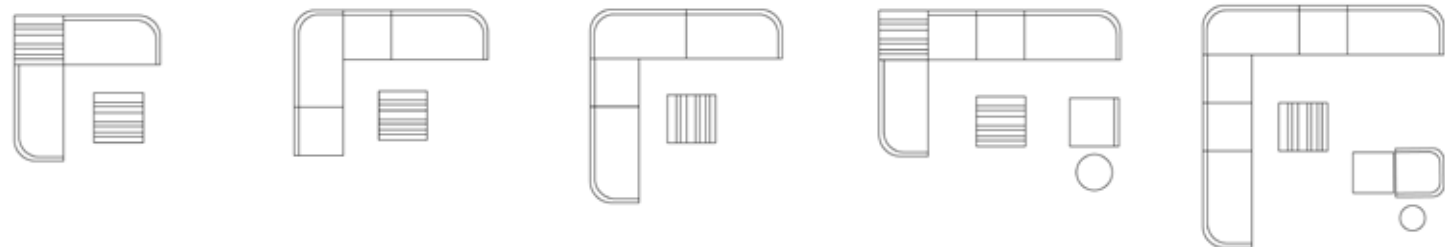

LENTO MODULAR OTTOMAN
P 13



LEO MODULAR CONNECTING SIDE TABLE
P 12

MODULAR SOFAS

SUNLOUNGERS



LUCY MODULAR SET
P 125



LUCY MODULAR CORNER
P 125



LUCY MODULAR CENTER
P 125



LUCY MODULAR OTTOMAN
P 125



LUCY MODULAR COFFEE TABLE
P 124

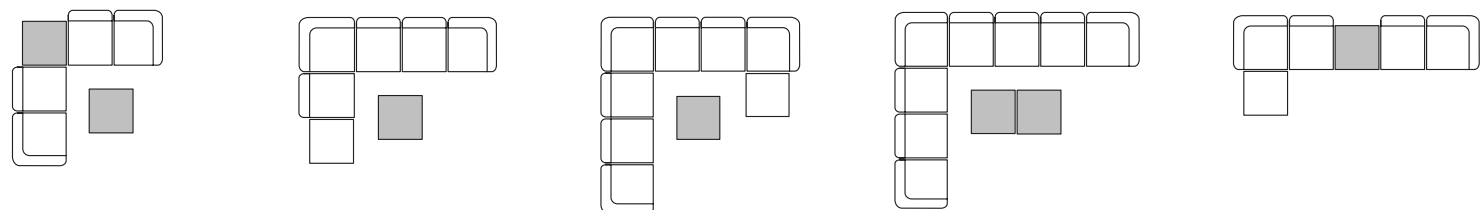

DAVID SUNLOUNGER
P 43



KODO SUNLOUNGER
P 31



LOOP SUNLOUNGER
P 106



LUCY SUNLOUNGER
P 122



SAFI SUNLOUNGER SYNTHETIC
P 145



SAFI SUNLOUNGER WITH ARMS SYNTHETIC
P 145



DOVILE SUNLOUNGER WITH ARMS LLOYD LOOM
P 158

TABLES



LOOP DINING TABLE
P 107



DAVID DINING TABLE
P 43



KODO DINING TABLE
P 29



RONDA BISTRO TABLE
P 128



SPHERA BISTRO TABLE
P 128



QUADRO BISTRO TABLE
P 128



LEO DINING TABLE
P 82



MAX DINING TABLE
P 129



WICKED DINING TABLE
P 55



NIMES DINING TABLE LLOYD LOOM
P 156



SAFI DINING TABLE SYNTHETIC
P 146



MATTEO DINING TABLE
P 72



MATTEO BENCH
P 72

COFFEE & SIDE TABLES



LEO COFFEE & SIDE TABLES
P 82



ANTON TEAK COFFEE AND SIDE TABLES
P 63



LENTO COFFEE & SIDE TABLES
P 10



DAVID COFFEE TABLE DIA 68 & SIDE TABLE DIA 40
P 40



ROZY COFFEE TABLE
P 109



ROZY SIDE TABLE
P 109



DAVID COFFEE TABLE 129 X 45 & SIDE TABLE 41 X 41
P 40



DAVID COFFEE TABLE 120 X 120
P 40



LOOP COFFEE TABLE
P 104



LOOP SIDE TABLE
P 104



KODO COFFEE TABLE & SIDE TABLE
P 030



WICKED COFFEE TABLE & SIDE TABLE
P 052



COFFEE & SIDE TABLES

ACCESSORIES



IVO COFFEE TABLE
P 110



IVO SIDE TABLE
P 0110



TIKA LANTERN
P 67



MORA LANTERN
P 64



AVIGNON SIDE TABLE LLOYD LOOM
P 159



DOVILE COFFEE AND SIDE TABLE LLOYD LOOM
P 158



IVO PLANT STAND
P 114



LIGHT MY TABLE
P 72



SAFI SIDE TABLE SYNTHETIC
P 145



LUCY SIDE TABLE
P 124

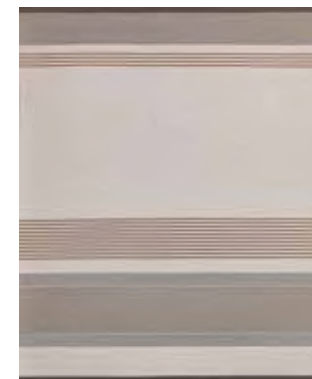

TOUNDRA RUG
P 112



CLIFF RUG
P 112

OUR HISTORY



ESTABLISHMENT VINCENT SHEPPARD

In 1992, Belgian company Vincent Sheppard picks up the thread and establishes an import business of Lloyd Loom furniture. They manage to breathe new life into the traditional technique and develop an attractive and modern furniture collection. The success is immense.

1992

1917

INVENTION OF LLOYD LOOM

American entrepreneur Marshall Burns Lloyd invents an entirely new paper weave, which he calls 'Lloyd loom'. The technique consists of twisting Kraft paper around a steel wire on a loom.



1995

PRODUCTION PLANT IN INDONESIA

Vincent Sheppard builds its own factory in Cirebon, Indonesia, an area famous for its tradition in weaving techniques and rattan bending. By setting up a production facility, Vincent Sheppard becomes one of the very few vertically integrated Lloyd Loom manufacturers.



The mark of
responsible forestry
FSC® C116790

FSC CERTIFIED

Vincent Sheppard is certified by the Forest Stewardship Council, a symbol of environmental, social and economic sustainability in 2013. A great reward for our efforts in creating stylish and eco-friendly furniture with respect for nature and men.

2013

VINCENT
SHEPPARD



TODAY

Today, Vincent Sheppard is a thriving, healthy company with a clear focus on the future. We build on our strong history and invaluable expertise to keep on offering unique and timeless designs that will last a lifetime. Our brand stands for exceptional seating comfort, high quality, and durable materials. Next to the famous Lloyd Loom weave, we also make use of other materials such as rattan, oak, beech and teak wood, along with steel and aluminium, which fit with our DNA of craftsmanship, quality and distinctive design.

2022

2014

OUTDOOR FURNITURE

In 2014, Vincent Sheppard launches its new brand Vincent's garden. As the demand for qualitative and durable outdoor furniture increases, Vincent Sheppard decides to translate its iconic designs into materials that withstand all weather conditions.

Vincent's
garden
LET'S GO OUTSIDE

VINCENT SHEPPARD HQ BELGIUM

Industriepark 5
8587 Spiere - Belgium
+32 56 46 11 11
info@vincentsheppard.com
www.vincentsheppard.com

