



ADEZZ<sup>®</sup>

WE PRODUCE GARDEN PRODUCTS FOR PROFESSIONALS

2021



Aluminum  
3 mm

## Walls Aluminum

Aluminum walls are the perfect way to create a haven in your garden. It is possible to produce almost any size and they are available in almost all standard RAL colours. These are very rigid walls with a mounting strip on the base. To clean this product, we recommend "Cleaner and protector set", specially developed for cleaning of Aluminum, which is available from us.

Standard colours are **RAL 7021, 7035, 9016**. Almost all other standard RAL colours are possible (beware of start-up costs).

5 year warranty



Cleaner and protector



YARD Garden Style  
Petworth, West Sussex, GU28 9ET  
[www.yardgardenstyle.co.uk](http://www.yardgardenstyle.co.uk) | Tel: 01428 707315 Email:  
[hello@yardgardenstyle.co.uk](mailto:hello@yardgardenstyle.co.uk)

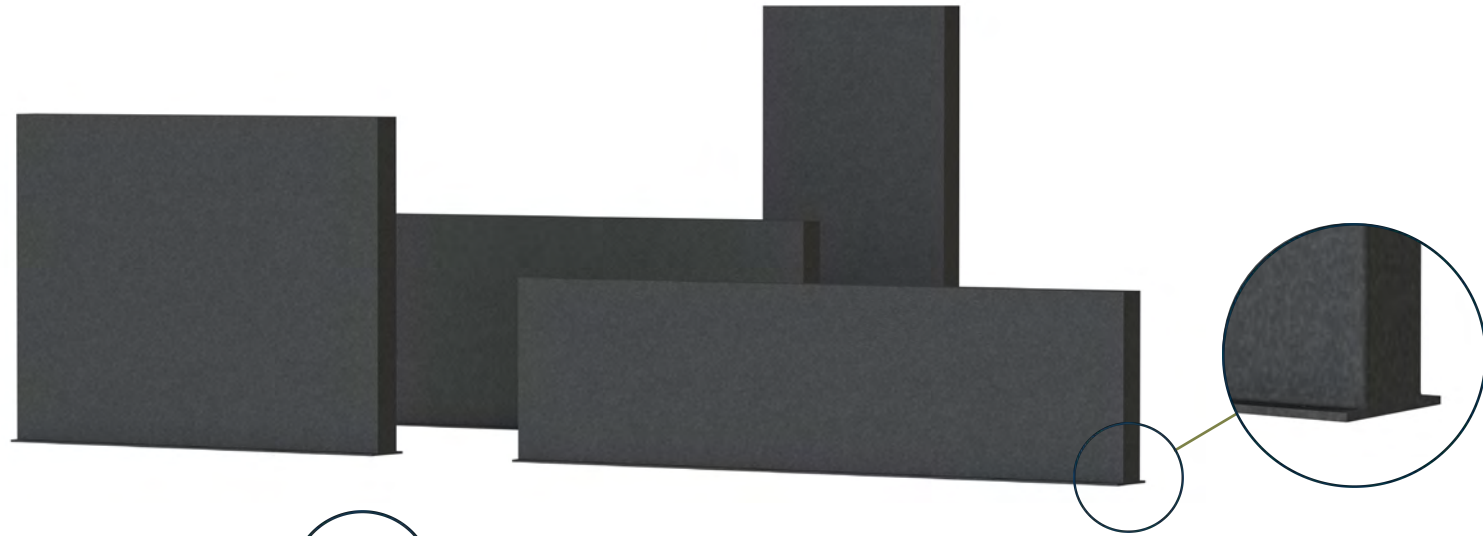

Custom  
Made  
Possible  
(6m max)

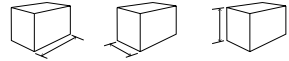

**KG**

AW1	4000	150	2000 mm	141
AW1.1	"	"	1350 mm	103
AW1.2	"	"	1000 mm	75
AW1.3	"	"	800 mm	63
AW1.4	"	"	600 mm	50
AW2	3000	150	2000 mm	107
AW2.1	"	"	1350 mm	75
AW2.2	"	"	1000 mm	57
AW2.3	"	"	800 mm	47
AW2.4	"	"	600 mm	38
AW3	2000	150	2000 mm	73
AW3.1	"	"	1350 mm	51
AW3.2	"	"	1000 mm	39
AW3.3	"	"	800 mm	32
AW3.4	"	"	600 mm	26
AW4	1500	150	2000 mm	58
AW4.1	"	"	1350 mm	40
AW4.2	"	"	1000 mm	31
AW4.3	"	"	800 mm	25
AW4.4	"	"	600 mm	20
AW5	1000	150	2000 mm	39
AW5.1	"	"	1350 mm	27
AW5.2	"	"	1000 mm	21
AW5.3	"	"	800 mm	17
AW5.4	"	"	600 mm	14





Corten Steel  
2 mm

## Walls Corten Steel

The Corten steel walls are extremely rigid, which can be mounted to any surface using the mounting strip along the length of the base. The advantage of our Corten Steel Walls is that they have a hollow construction, so you can simply add lighting etc.

Benefits Corten Steel walls:

- Cheaper than comparable walls
- Very rigid material
- Easy to create surprising views
- Natural appearance
- Custom made possible
- 5 year warranty



Rust accelerator



YARD Garden Style  
Petworth, West Sussex, GU28 9ET  
[www.yardgardenstyle.co.uk](http://www.yardgardenstyle.co.uk) | Tel: 01428 707315 Email:  
[hello@yardgardenstyle.co.uk](mailto:hello@yardgardenstyle.co.uk)



Custom  
Made  
Possible  
(6m max)

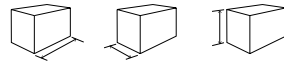

**KG**

CW1	4000	150	2000 mm	282
CW1.1	"	"	1350 mm	205
CW1.2	"	"	1000 mm	149
CW1.3	"	"	800 mm	122
CW1.4	"	"	600 mm	96
CW2	3000	150	2000 mm	214
CW2.1	"	"	1350 mm	149
CW2.2	"	"	1000 mm	113
CW2.3	"	"	800 mm	93
CW2.4	"	"	600 mm	73
CW3	2000	150	2000 mm	146
CW3.1	"	"	1350 mm	101
CW3.2	"	"	1000 mm	77
CW3.3	"	"	800 mm	64
CW3.4	"	"	600 mm	50
CW4	1500	150	2000 mm	146
CW4.1	"	"	1350 mm	101
CW4.2	"	"	1000 mm	77
CW4.3	"	"	800 mm	64
CW4.4	"	"	600 mm	38
CW5	1000	150	2000 mm	78
CW5.1	"	"	1350 mm	54
CW5.2	"	"	1000 mm	41
CW5.3	"	"	800 mm	34
CW5.4	"	"	600 mm	26





Corten Steel  
2 mm

Aluminum  
3 mm

## DECORATIVE LASERCUT PANELS

IN CORTEN STEEL AND POWDER COATED ALUMINUM

ADEZZ® decorative panels in Corten steel and Aluminum.

Transparent panels help to give structure to your garden and can be used to create private intimate areas in the most exposed environments.

ADEZZ® decorative panels have a simple unique link system and are characterised by:

- High stability due to folded edges
- Materials; Corten steel or Aluminum with a scratch-resistant colour coating
- Various fixing methods; on the floor / between columns, posts and walls
- Easy installation through good access to the fixing elements
- T-profiles available for placing in concrete and invisible connection of the panels.
- Rounded edge with tight frame on all sides which gives the panels stability
- Timeless design and applicable in any garden
- 5 year warranty

Dimensions of the panels: Width 1100mm and Height 1800mm.

We have all designs in stock. The panels can be quickly and easily applied in your garden design.

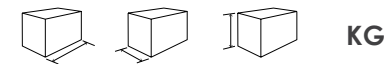

	106	60	2700 mm	KG
CPP1				20
APP1	"	"	"	16



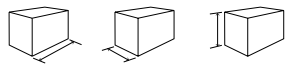

**KG**

APB1	1100	50	1800 mm	16
APB2	600	"	"	9
APN1	1100	50	1800 mm	16
APN2	"	"	"	"
APN3	"	"	"	"
APN4	"	"	"	"
APN5	"	"	"	"
APN6	"	"	"	"
APN7	"	"	"	"
APN8	"	"	"	"
APN9	"	"	"	"
APN10	"	"	"	"
APN11	"	"	"	"
APA2.1	1100	50	1800 mm	16
APA2.2	"	"	"	"
APA2.3	"	"	"	"
APA2.4	"	"	"	"
APA3	1100	50	1800 mm	16
APA4	"	"	"	"
APA5	"	"	"	"
APA6	"	"	"	"
APA7	"	"	"	"
APA8	1100	50	1800 mm	16
APA8.1	"	"	"	"
APA8.2	"	"	"	"

Visit our website for all designs: [www.adezz.com](http://www.adezz.com)

New



CPB1

CPA3

CPN1

CPN6

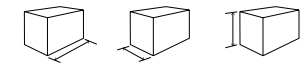

**KG**

CPB1	1100	50	1800 mm	38
CPB2	600	"	"	23
CPN1	1100	50	1800 mm	38
CPN2	"	"	"	"
CPN3	"	"	"	"
CPN4	"	"	"	"
CPN5	"	"	"	"
CPN6	"	"	"	"
CPN7	"	"	"	"
CPN8	"	"	"	"
CPN9	"	"	"	"
CPN10	"	"	"	"
CPN11	"	"	"	"
CPA2.1	1100	50	1800 mm	38
CPA2.2	"	"	"	"
CPA2.3	"	"	"	"
CPA2.4	"	"	"	"
CPA3	1100	50	1800 mm	38
CPA4	"	"	"	"
CPA5	"	"	"	"
CPA6	"	"	"	"
CPA7	"	"	"	"
CPA8	1100	50	1800 mm	38
CPA8.1	"	"	"	"
CPA8.2	"	"	"	"

New

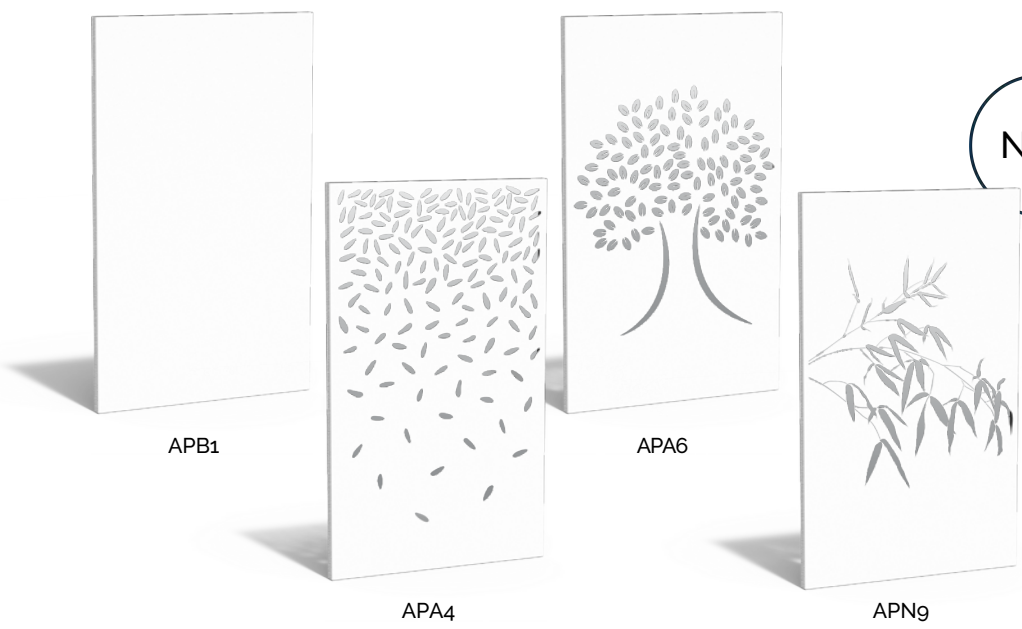

APB1

APA4

APA6

APN9

Visit our website for all designs: [www.adezz.com](http://www.adezz.com)





Corten Steel  
2 mm

Aluminum  
3 mm

## Pedestals

We make Solid and U-shaped pedestals in different sizes, allowing you to display objects upto 150kg. The openwork pedestal (U-block) can also be used as a wood storage unit.

5 year warranty



Rust accelerator



Cleaner and protector



Corten Varnish



YARD Garden Style  
Petworth, West Sussex, GU28 9ET  
www.yardgardenstyle.co.uk | Tel: 01428 707315 Email:  
hello@yardgardenstyle.co.uk









Pedestals (CK)

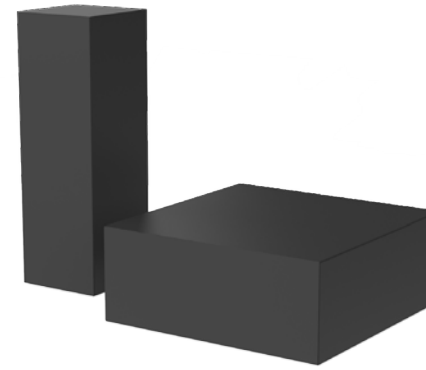



Pedestals U block (CKU)



Aluminum pedestals (AS)

				<b>KG</b>
CK1	500	500	1200 mm	42
CK2	"	"	1000 mm	36
CK3	"	"	800 mm	29
CK4	"	"	600 mm	23
CK5	400	400	1200 mm	33
CK6	"	"	1000 mm	28
CK7	"	"	800 mm	23
CK8	"	"	600 mm	18
CK9	"	"	400 mm	13
CK10	300	300	1000 mm	21
CK11	"	"	800 mm	17
CK12	"	"	600 mm	13
CK13	"	"	400 mm	9
CK20	1200	1200	400 mm	54
CK21	1000	1000	"	42
CK22	800	800	"	31
CK23	600	600	"	21
CK30	2000	400	400 mm	44
CK31	1500	"	"	34
CK32	1000	"	"	24
CKU1	500	500	1200 mm	52
CKU2	"	"	1000 mm	44
CKU3	"	"	800 mm	37
CKU4	"	"	600 mm	29
CKU5	400	400	1200 mm	41
CKU6	"	"	1000 mm	35
CKU7	"	"	800 mm	29
CKU8	"	"	600 mm	23
CKU9	"	"	400 mm	17

				<b>KG</b>
AS1	500	500	1200 mm	23
AS2	"	"	1000 mm	19
AS3	"	"	800 mm	16
AS4	"	"	600 mm	12
AS5	400	400	1200 mm	18
AS6	"	"	1000 mm	15
AS7	"	"	800 mm	12
AS8	"	"	600 mm	10
AS9	"	"	400 mm	7
AS10	300	300	1000 mm	11
AS11	"	"	800 mm	9
AS12	"	"	600 mm	7
AS13	"	"	400 mm	5
AS20	1200	1200	400 mm	29
AS21	1000	1000	"	22
AS22	800	800	"	16
AS23	600	600	"	11
AS30	2000	400	400 mm	23
AS31	1500	"	"	18
AS32	1000	"	"	13





## Letterboxes

We have three timeless mailbox models in our collection, which are available in either Corten Steel or powder coated Aluminum. The Aluminum powder coated version can be supplied in almost any RAL colour and it is possible to order numbers and letters for any of the models. All letterboxes have a lockable door and are supplied with two keys.

Standard colours Aluminum: **RAL 7021, 7035, 9016**. Almost all other standard RAL colours are possible (beware of start-up costs).

5 year warranty

Available in Corten Steel and stainless steel:

**0, 1, 2, 3, 4, 5, 6, 7, 8, 9, a, b, c, d**



YARD Garden Style  
Petworth, West Sussex, GU28 9ET  
[www.yardgardenstyle.co.uk](http://www.yardgardenstyle.co.uk) | Tel: 01428 707315 Email:  
[hello@yardardenstyle.co.uk](mailto:hello@yardardenstyle.co.uk)



Ivar



Hacon



Flyn



**KG**

Ivar IVC1	Corten	350	350	1200 mm	34
Ivar IVA1	Aluminum	"	"	"	18
Hacon HAC1	Corten	350	350	1200 mm	34
Hacon HAA1	Aluminum	"	"	"	18
Flyn LFC1	Corten	350	350	1200 mm	41
Flyn LFA1	Aluminum	"	"	"	18





## CASE package box

Online shopping has become indispensable. You either stay home or burden your neighbours with receiving your package. Package box CASE solves this problem. Your order can be delivered to your address in your absence in an elegant way. By applying a valve the package will fall in the package box and can only be retrieved by you. The finish is stylish and compact. It is also a mail box and your house number can be applied easily. Available in Corten Steel and Aluminum.

The CASE package box is equipped with a Soft Close mechanism for increased ease of use.

5 year warranty

Standard colours Aluminum: **RAL 7021, 7035, 9016**. Almost all other standard RAL colours are possible (start-up costs apply here).



YARD Garden Style  
Petworth, West Sussex, GU28 9ET  
[www.yardgardenstyle.co.uk](http://www.yardgardenstyle.co.uk) | Tel: 01428 707315 Email:  
[hello@yardgardenstyle.co.uk](mailto:hello@yardgardenstyle.co.uk)



Case

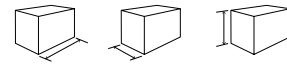

**KG**

Case PCC1 Corten  
Case PCA1 Aluminum

500  
"

400  
"

1200mm  
"

58  
30

Maximum package size 400x300x250 mm

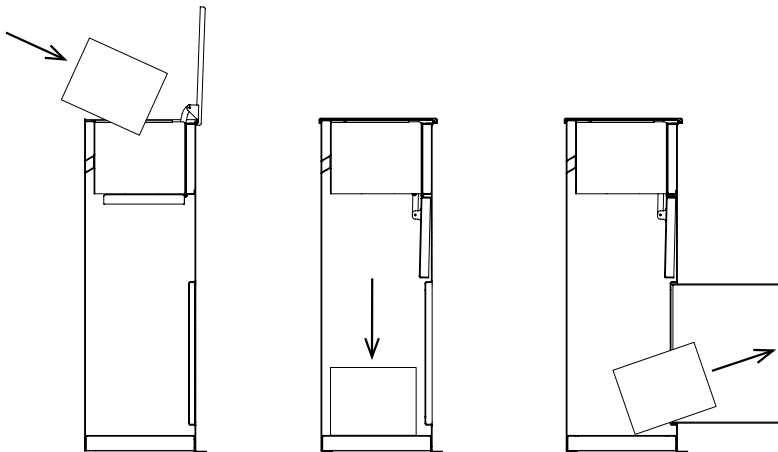



## PACA package box

Online shopping has become indispensable. You either stay home or burden your neighbours with receiving your package. Package box PACA solves this problem. Your order can be delivered to your address in your absence in an elegant way. By applying a valve the package will fall in the package box and can only be retrieved by you. The finish is stylish and compact. It is also a mail box and your house number can be applied easily. Available in Corten Steel and Aluminum.

The PACA package box is equipped with a Soft Open mechanism for increased ease of use.

5 year warranty

Standard colours Aluminum: **RAL 7021, 7035, 9016**. Almost all other standard RAL colours are possible (start-up costs apply here).



YARD Garden Style  
Petworth, West Sussex, GU28 9ET  
[www.yardgardenstyle.co.uk](http://www.yardgardenstyle.co.uk) | Tel: 01428 707315 Email:  
[hello@yardgardenstyle.co.uk](mailto:hello@yardgardenstyle.co.uk)



Paca

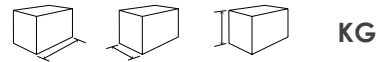

		870	300	1250mm	KG
Paca PPS1	Corten	"	"	"	110
Paca PPA1	Aluminum	"	"	"	41

Maximum package size 600x400x240 mm

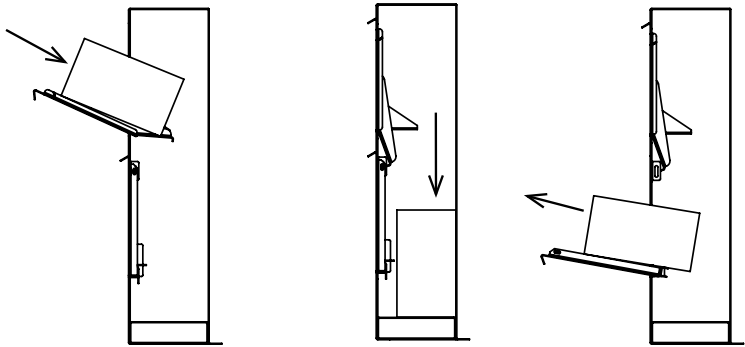



Corten Steel  
4 mm

Aluminum  
4 mm

## Stairs

We offer ready made garden staircases in Corten Steel for height differences in your garden. The width of these stairs may range from 1000mm to 3000mm.

The steps have a standard height of 170 mm and we produce a staircase with a maximum of 10 or 17 steps.

Also available in Aluminum (4mm).

Standard colour Aluminum: **RAL 9005**. Almost all other standard RAL colours are possible (start-up costs apply here).

Stairs are made to order therefore never in stock. Delivery time is 3 weeks.

5 year warranty

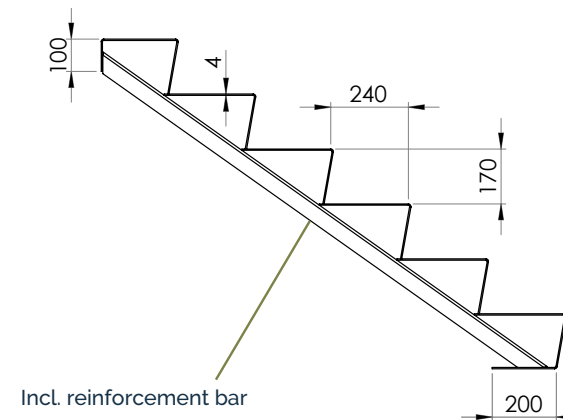





Corten steel stairs (CST)



Aluminum stairs (AST)

Custom  
Made  
Possible

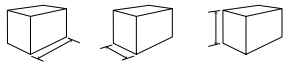

**KG**

<b>CST2.1</b> 2 steps	<b>1000</b>	480	340 mm	41
extra step (max 17)	"	240	170 mm	18
<b>CST2.2</b> 2 steps	<b>1250</b>	480	340 mm	50
extra step (max 17)	"	240	170 mm	21
<b>CST2.3</b> 2 steps	<b>1500</b>	480	340 mm	62
extra step (max 10)	"	240	170 mm	27
<b>CST2.4</b> 2 steps	<b>2000</b>	480	340 mm	80
extra step (max 10)	"	240	170 mm	33
<b>CST2.5</b> 2 steps	<b>2500</b>	480	340 mm	101
extra step (max 10)	"	240	170 mm	42
<b>CST2.6</b> 2 steps	<b>3000</b>	480	340 mm	119
extra step (max 10)	"	240	170 mm	49

Custom  
Made  
Possible

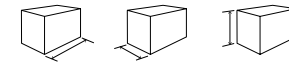

**KG**

<b>AST2.1</b> 2 steps	<b>1000</b>	480	340 mm	15
extra step (max 17)	"	240	170 mm	7
<b>AST2.2</b> 2 steps	<b>1250</b>	480	340 mm	17
extra step (max 17)	"	240	170 mm	8
<b>AST2.3</b> 2 steps	<b>1500</b>	480	340 mm	23
extra step (max 10)	"	240	170 mm	9
<b>AST2.4</b> 2 steps	<b>2000</b>	480	340 mm	28
extra step (max 10)	"	240	170 mm	12
<b>AST2.5</b> 2 steps	<b>2500</b>	480	340 mm	36
extra step (max 10)	"	240	170 mm	15
<b>AST2.6</b> 2 steps	<b>3000</b>	480	340 mm	43
extra step (max 10)	"	240	170 mm	17





Material  
2 + 3 mm

# Edging

We produce our edging in galvanised steel and Corten Steel. Available in five heights 100, 150, 200, 290 and 390mm and the thickness of the material can be 2 or 3 mm. The length of the strips is 2300 mm. You can also choose from simple straight strips or the top angle of 90 degrees or flattened (180 degrees).

5 year warranty



Roof support (PKV1)



Edging pegs (PK)

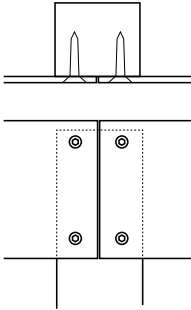

### Edging pegs PK

- PK 1 / 50x50x400 mm ( 25 pcs )
- PK 2 / 50x50x600 mm ( 25 pcs )
- PK 3 / 50x50x800 mm ( 25 pcs )

- PKC1 / Steel 30x30x600 mm ( 25 pcs )
- PKV1 / Steel roof support for 2mm edging

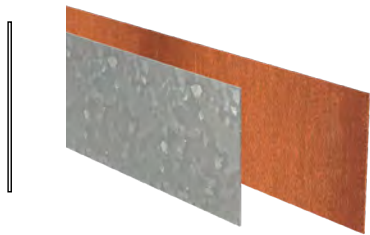
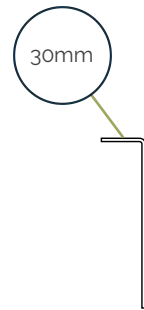
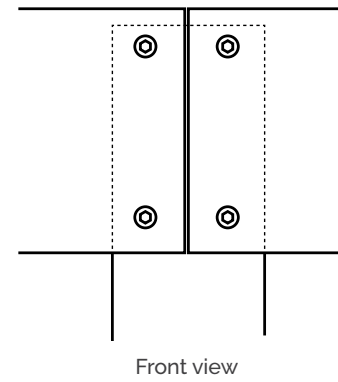
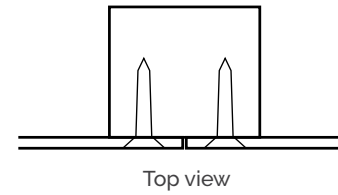
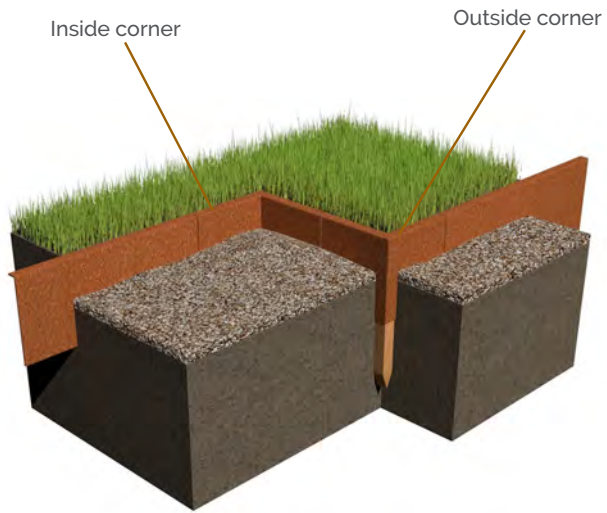

Edging straight  
2300 X (H)100, 150, 200, 290 of 390



Edging put metal  
2300 X (H)100, 150, 200, 290 of 390

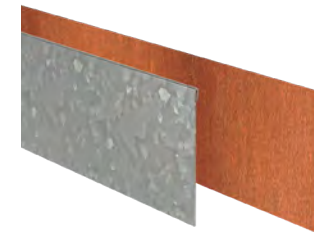
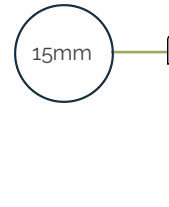

Edging flattened  
2300 X (H)100, 150, 200, 290 of 390

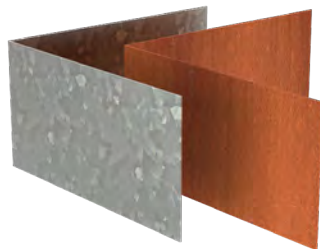

Corner inside or outside straight  
300 X 300 (H)100, 150, 200, 290 of 390

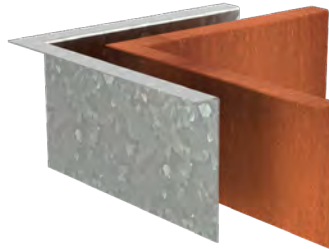

Corner inside or outside put metal  
300 X 300 (H)100, 150, 200, 290 of 390

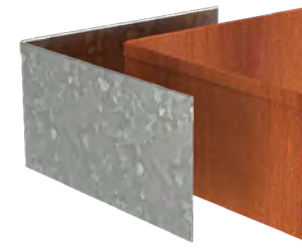

Corner inside or outside flattened  
300 X 300 (H)100, 150, 200, 290 of 390



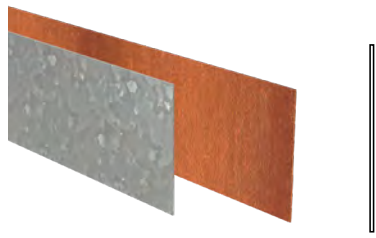

Edging straight (2300mm)

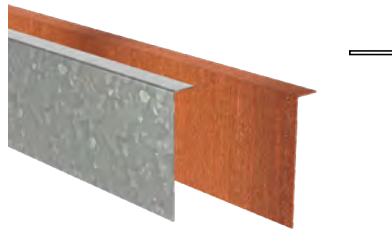

Edging put metal (2300mm)

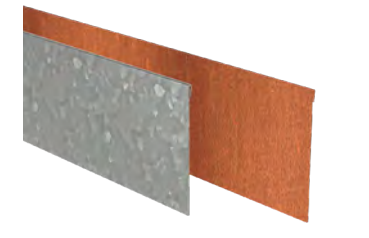

Edging flattened (2300mm)

Height	Thickness	Strips	
100mm	2mm	25	C/VR2 100 25
		10	C/VR2 100 10
150mm	2mm	25	C/VR2 150 25
		10	C/VR2 150 10
	3mm	25	C/VR3 150 25
		10	C/VR3 150 10
200mm	2mm	25	C/VR2 200 25
		10	C/VR2 200 10
	3mm	25	C/VR3 200 25
		10	C/VR3 200 10
290mm	2mm	25	C/VR2 290 25
		10	C/VR2 290 10
	3mm	25	C/VR3 290 25
		10	C/VR3 290 10
390mm	2mm	25	C/VR2 390 25
		10	C/VR2 390 10
	3mm	25	C/VR3 390 25
		10	C/VR3 390 10

For Corten use code C  
For Galvanised use code V

**8 countersunk holes incl. TX-20 screws per strip, this is optional at additional cost.**

Height	Thickness	Strips	
100mm	2mm	25	C/VZ2 100 25
		10	C/VZ2 100 10
150mm	2mm	25	C/VZ2 150 25
		10	C/VZ2 150 10
	3mm	25	C/VZ3 150 25
		10	C/VZ3 150 10
200mm	2mm	25	C/VZ2 200 25
		10	C/VZ2 200 10
	3mm	25	C/VZ3 200 25
		10	C/VZ3 200 10
290mm	2mm	25	C/VZ2 290 25
		10	C/VZ2 290 10
	3mm	25	C/VZ3 290 25
		10	C/VZ3 290 10
390mm	2mm	25	C/VZ2 390 25
		10	C/VZ2 390 10
	3mm	25	C/VZ3 390 25
		10	C/VZ3 390 10

For Corten use code C  
For Galvanised use code V

**8 countersunk holes incl. TX-20 screws per strip, this is optional at additional cost.**

Height	Thickness	Strips	
100mm	2mm	25	C/VP2 100 25
		10	C/VP2 100 10
150mm	2mm	25	C/VP2 150 25
		10	C/VP2 150 10
	3mm	25	C/VP3 150 25
		10	C/VP3 150 10
200mm	2mm	25	C/VP2 200 25
		10	C/VP2 200 10
	3mm	25	C/VP3 200 25
		10	C/VP3 200 10
290mm	2mm	25	C/VP2 290 25
		10	C/VP2 290 10
	3mm	25	C/VP3 290 25
		10	C/VP3 290 10
390mm	2mm	25	C/VP2 390 25
		10	C/VP2 390 10
	3mm	25	C/VP3 390 25
		10	C/VP3 390 10

For Corten use code C  
For Galvanised use code V

**8 countersunk holes incl. TX-20 screws per strip, this is optional at additional cost.**

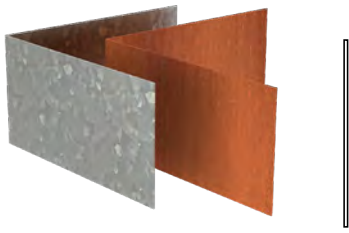

Corner straight (300x300mm)



Corner put metal (300x300mm)

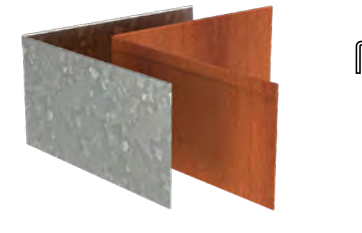

Corner flattened (300x300mm)

Height	Thickness	Corner	
100mm	2mm	outside	<b>C/VR2 100 BU</b>
		inside	<b>C/VR2 100 BI</b>
150mm	2mm	outside	<b>C/VR2 150 BU</b>
		inside	<b>C/VR2 150 BI</b>
	3mm	outside	<b>C/VR3 150 BU</b>
		inside	<b>C/VR3 150 BI</b>
200mm	2mm	outside	<b>C/VR2 200 BU</b>
		inside	<b>C/VR2 200 BI</b>
	3mm	outside	<b>C/VR3 200 BU</b>
		inside	<b>C/VR3 200 BI</b>
290mm	2mm	outside	<b>C/VR2 290 BU</b>
		inside	<b>C/VR2 290 BI</b>
	3mm	outside	<b>C/VR3 290 BU</b>
		inside	<b>C/VR3 290 BI</b>
390mm	2mm	outside	<b>C/VR2 390 BU</b>
		inside	<b>C/VR2 390 BI</b>
	3mm	outside	<b>C/VR3 390 BU</b>
		inside	<b>C/VR3 390 BI</b>

For Corten use code C  
For Galvanised use code V

**4 countersunk holes incl. TX-20 screws per corner element, optional at additional cost.**

Height	Thickness	Corner	
100mm	2mm	outside	<b>C/VZ2 100 BU</b>
		inside	<b>C/VZ2 100 BI</b>
150mm	2mm	outside	<b>C/VZ2 150 BU</b>
		inside	<b>C/VZ2 150 BI</b>
	3mm	outside	<b>C/VZ3 150 BU</b>
		inside	<b>C/VZ3 150 BI</b>
200mm	2mm	outside	<b>C/VZ2 200 BU</b>
		inside	<b>C/VZ2 200 BI</b>
	3mm	outside	<b>C/VZ3 200 BU</b>
		inside	<b>C/VZ3 200 BI</b>
290mm	2mm	outside	<b>C/VZ2 290 BU</b>
		inside	<b>C/VZ2 290 BI</b>
	3mm	outside	<b>C/VZ3 290 BU</b>
		inside	<b>C/VZ3 290 BI</b>
390mm	2mm	outside	<b>C/VZ2 390 BU</b>
		inside	<b>C/VZ2 390 BI</b>
	3mm	outside	<b>C/VZ3 390 BU</b>
		inside	<b>C/VZ3 390 BI</b>

For Corten use code C  
For Galvanised use code V

**4 countersunk holes incl. TX-20 screws per corner element, optional at additional cost.**

Height	Thickness	Corner	
100mm	2mm	outside	<b>C/VP2 100 BU</b>
		inside	<b>C/VP2 100 BI</b>
150mm	2mm	outside	<b>C/VP2 150 BU</b>
		inside	<b>C/VP2 150 BI</b>
	3mm	outside	<b>C/VP3 150 BU</b>
		inside	<b>C/VP3 150 BI</b>
200mm	2mm	outside	<b>C/VP2 200 BU</b>
		inside	<b>C/VP2 200 BI</b>
	3mm	outside	<b>C/VP3 200 BU</b>
		inside	<b>C/VP3 200 BI</b>
290mm	2mm	outside	<b>C/VP2 290 BU</b>
		inside	<b>C/VP2 290 BI</b>
	3mm	outside	<b>C/VP3 290 BU</b>
		inside	<b>C/VP3 290 BI</b>
390mm	2mm	outside	<b>C/VP2 390 BU</b>
		inside	<b>C/VP2 390 BI</b>
	3mm	outside	<b>C/VP3 390 BU</b>
		inside	<b>C/VP3 390 BI</b>

For Corten use code C  
For Galvanised use code V

**4 countersunk holes incl. TX-20 screws per corner element, optional at additional cost.**





## Retaining walls

With our range of retaining walls you can endlessly combine and almost any shape can be realised easily and quickly in your garden design. A prefab system which is easy to install with the supplied fasteners. These retaining walls have a top edge of 50x25mm as standard.

Options:

- Available in 2 different materials: Corten Steel and powder coated Aluminum
- Height: 200, 300, 400 and 600mm
- Straight pieces in length: 1000, 1500 and 2000mm
- Inside and outside corners, in lengths of 500 and 1000mm
- Inside and outside curves, with radius of 500, 1000, 1500 and 2000mm

Retaining walls are made to order therefore never in stock. Delivery time is 3 weeks.

5 year warranty



YARD Garden Style  
Petworth, West Sussex, GU28 9ET  
www.yardgardenstyle.co.uk | Tel: 01428 707315 Email:  
hello@yardgardenstyle.co.uk

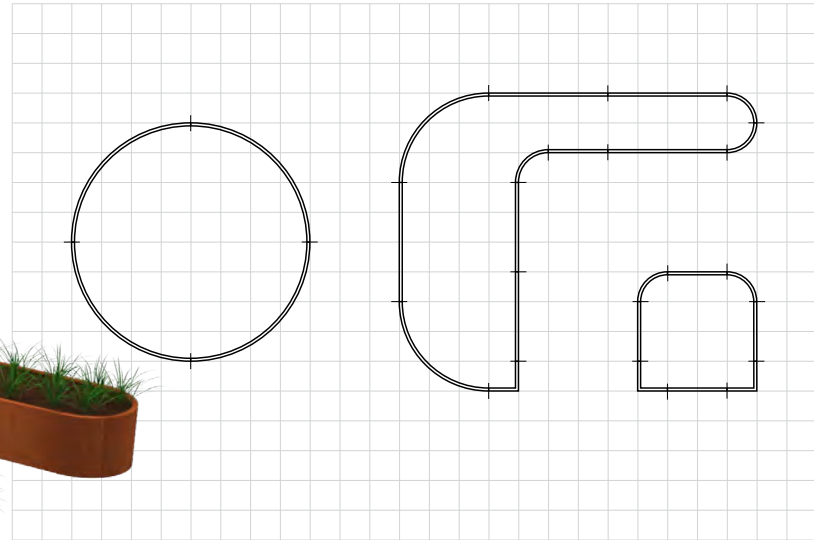

Retaining wall Straight  
1000mm  
1500mm  
2000mm

Retaining wall Outside corner  
500mm  
1000mm

Retaining wall Inside corner  
500mm  
1000mm

Retaining wall Outside curve  
500mm  
1000mm  
1500mm  
2000mm

Retaining wall Inside curve  
500mm  
1000mm  
1500mm  
2000mm

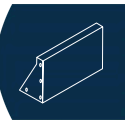
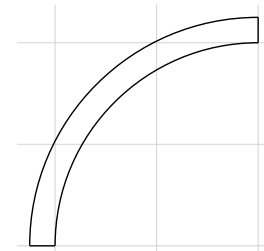
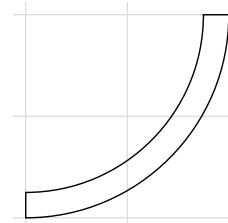
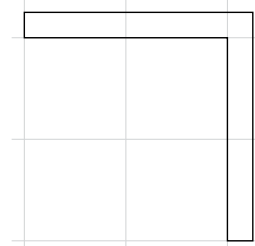
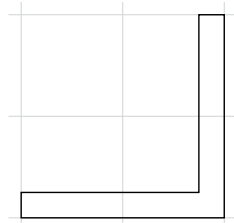
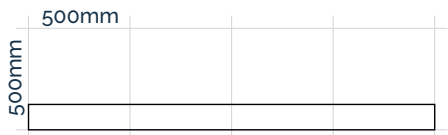

CORTEN



**KG**

CRS2.200.1000 straight	1000	6
CRS2.200.1500 straight	1500	9
CRS2.200.2000 straight	2000	12
CRSN2.200.500 inside corner	500	6
CRSO2.200.500 outside corner	"	6
CRSN2.200.1000 inside corner	1000	11
CRSO2.200.1000 outside corner	"	11
CRCN2.200.500 inside curve	200 500	5
CRCO2.200.500 outside curve	"	4
CRCN2.200.1000 inside curve	1000	9
CRCO2.200.1000 outside curve	"	9
CRCN2.200.1500 inside curve	1500	13
CRCO2.200.1500 outside curve	"	13
CRCN2.200.2000 inside curve	2000	17
CRCO2.200.2000 outside curve	"	17

ALUMINIUM

ARS3.200.1000 straight	1000	3
ARS3.200.1500 straight	1500	4
ARS3.200.2000 straight	2000	6
ARSN3.200.500 inside corner	500	3
ARSO3.200.500 outside corner	"	3
ARSN3.200.1000 inside corner	1000	6
ARSO3.200.1000 outside corner	"	6
ARCN3.200.500 inside curve	200 500	2
ARCO3.200.500 outside curve	"	2
ARCN3.200.1000 inside curve	1000	4
ARCO3.200.1000 outside curve	"	4
ARCN3.200.1500 inside curve	1500	7
ARCO3.200.1500 outside curve	"	7
ARCN3.200.2000 inside curve	2000	9
ARCO3.200.2000 outside curve	"	9

CORTEN





**KG**

CRS2.300.1000 straight	1000	9
CRS2.300.1500 straight	1500	14
CRS2.300.2000 straight	2000	18
CRSN2.300.500 inside corner	500	8
CRSO2.300.500 outside corner	"	8
CRSN2.300.1000 inside corner	1000	16
CRSO2.300.1000 outside corner	"	15
CRCN2.300.500 inside curve	300 500	7
CRCO2.300.500 outside curve	"	6
CRCN2.300.1000 inside curve	1000	13
CRCO2.300.1000 outside curve	"	13
CRCN2.300.1500 inside curve	1500	19
CRCO2.300.1500 outside curve	"	19
CRCN2.300.2000 inside curve	2000	25
CRCO2.300.2000 outside curve	"	24

ALUMINIUM



ARS3.300.1000 straight	1000	4
ARS3.300.1500 straight	1500	6
ARS3.300.2000 straight	2000	8
ARSN3.300.500 inside corner	500	4
ARSO3.300.500 outside corner	"	4
ARSN3.300.1000 inside corner	1000	8
ARSO3.300.1000 outside corner	"	8
ARCN3.300.500 inside curve	300 500	3
ARCO3.300.500 outside curve	"	3
ARCN3.300.1000 inside curve	1000	6
ARCO3.300.1000 outside curve	"	6
ARCN3.300.1500 inside curve	1500	10
ARCO3.300.1500 outside curve	"	10
ARCN3.300.2000 inside curve	2000	13
ARCO3.300.2000 outside curve	"	13



CORTEN			KG
CRS3.400.1000 straight		1000	17
CRS3.400.1500 straight		1500	25
CRS3.400.2000 straight		2000	33
CRSN3.400.500 inside corner		500	18
CRSO3.400.500 outside corner		"	16
CRSN3.400.1000 inside corner		1000	33
CRSO3.400.1000 outside corner		"	31
CRCN3.400.500 inside curve	400	500	15
CRCO3.400.500 outside curve		"	13
CRCN3.400.1000 inside curve		1000	27
CRCO3.400.1000 outside curve		"	26
CRCN3.400.1500 inside curve		1500	40
CRCO3.400.1500 outside curve		"	38
CRCN3.400.2000 inside curve		2000	52
CRCO3.400.2000 outside curve		"	51

## ALUMINIUM

ARS4.400.1000 straight		1000	8
ARS4.400.1500 straight		1500	12
ARS4.400.2000 straight		2000	15
ARSN4.400.500 inside corner		500	8
ARSO4.400.500 outside corner		"	7
ARSN4.400.1000 inside corner		1000	15
ARSO4.400.1000 outside corner		"	14
ARCN4.400.500 inside curve	400	500	6
ARCO4.400.500 outside curve		"	6
ARCN4.400.1000 inside curve		1000	12
ARCO4.400.1000 outside curve		"	11
ARCN4.400.1500 inside curve		1500	17
ARCO4.400.1500 outside curve		"	17
ARCN4.400.2000 inside curve		2000	23
ARCO4.400.2000 outside curve		"	22

CORTEN			KG
CRS3.600.1000 straight		1000	26
CRS3.600.1500 straight		1500	39
CRS3.600.2000 straight		2000	50
CRSN3.600.500 inside corner		500	24
CRSO3.600.500 outside corner		"	22
CRSN3.600.1000 inside corner		1000	44
CRSO3.600.1000 outside corner		"	42
CRCN3.600.500 inside curve	600	500	20
CRCO3.600.500 outside curve		"	18
CRCN3.600.1000 inside curve		1000	37
CRCO3.600.1000 outside curve		"	35
CRCN3.600.1500 inside curve		1500	54
CRCO3.600.1500 outside curve		"	53
CRCN3.600.2000 inside curve		2000	70
CRCO3.600.2000 outside curve		"	68

## ALUMINIUM

ARS4.600.1000 straight		1000	11
ARS4.600.1500 straight		1500	16
ARS4.600.2000 straight		2000	21
ARSN4.600.500 inside corner		500	10
ARSO4.600.500 outside corner		"	10
ARSN4.600.1000 inside corner		1000	21
ARSO4.600.1000 outside corner		"	21
ARCN4.600.500 inside curve	600	500	7
ARCO4.600.500 outside curve		"	7
ARCN4.600.1000 inside curve		1000	14
ARCO4.600.1000 outside curve		"	14
ARCN4.600.1500 inside curve		1500	21
ARCO4.600.1500 outside curve		"	21
ARCN4.600.2000 inside curve		2000	28
ARCO4.600.2000 outside curve		"	28

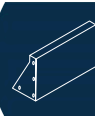



## Accessories

All our accessories meet the highest standards and are a perfect fit to our products.



Cleaner and protector



Descaler



Rust accelerator



Corten Varnish



Overflow pipe



Edging pegs (PK)



Roof support (PKV1)

OVL	Overflow pipe Ø22mm x H. 50mm
POL	Cleaner + Protector
CORT	Rust accelerator
ALU	Descaler
COR 0.5	Finish for Corten steel Owatrol 0.5 ltr.
COR 5.0	Finish for Corten steel Owatrol 5.0 ltr.
PK1	50x50x400 mm ( 25 pcs )
PK2	50x50x600 mm ( 25 pcs )
PK3	50x50x800 mm ( 25 pcs )
PKC1	30x30x600 mm ( 25 pcs ) 2 mm Steel edging pegs
PKV1	3 mm Steel roof support





YARD Garden Style  
Petworth, West Sussex, GU28 9ET  
[www.yardgardenstyle.co.uk](http://www.yardgardenstyle.co.uk) | Tel: 01428 707315  
Email: [hello@yardgardenstyle.co.uk](mailto:hello@yardgardenstyle.co.uk)

# ADEZZ®

WE PRODUCE GARDEN PRODUCTS FOR PROFESSIONALS

**ADEZZ®**

Production, distribution and sales  
Liessentstraat 4, 5405 AG Uden  
the Netherlands  
t. +31 (0)413 745 423  
[www.adezz.uk](http://www.adezz.uk) [info@adezz.uk](mailto:info@adezz.uk)

