



GAZE BURVILL

Furniture Specifications
& Prices

2020



Welcome to Gaze Burvill

"Creating the finest English outdoor furniture through an honest commitment to design integrity, comfort and craftsmanship."

That, in essence, is our objective and the oak collections presented in this booklet are our expression of it. As an established outdoor specialist with over a quarter century's experience in making furniture and kitchens designed to live outside, Gaze Burvill offers a wide variety of collections for every outdoor space, as well as having full capability to create either custom or fully bespoke designs.

Lodge Farm in the rolling Hampshire countryside has been our home since 2014, and we have established a unique capability here where our design team and state-of-the-art technology work side by side with the timeless skills of our experienced master craftsmen. Every aspect of what we make from initial concept to completed installation is managed from here, and the result is a superb level of care for detail and customer service.

We only use sustainably sourced wood from certified and expertly managed British and European forests. Using steam we shape solid Oak into distinctive, flowing curves that provide outstanding comfort and durability.

The Bowline Collection was developed in collaboration with some of the world's greatest yacht designers, to meet the exacting standards of their industry, using 316 marine-grade stainless steel frames. Each piece from this limited-edition collection offers an unparalleled combination of comfort, elegance and practicality.

We are an easy drive south of London and welcome visitors by appointment, either to visit the workshop, or sample our collections in our Flint Barn Showroom and Courtyard Garden.

See you there,

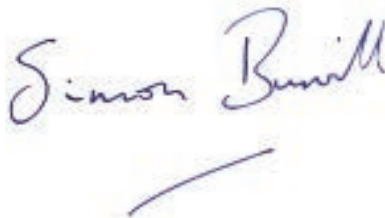
A handwritten signature in blue ink that reads "Simon Burvill". The signature is written in a cursive, flowing style. Below the signature is a single horizontal line.

Contents

Page No.

5	Craftsmanship
7	Design Integrity
9	Sustainability
10	About our Oak
	Lounging
12	Splash Lounge Modular Sofas
14	Splash Sofas, Chairs and Tables
16	Lizard Lounger
17	King Lizard Lounger
	Dining
18	Levity Tables & Chairs
20	Oak Dining Tables
	Seating
22	Occasional & Dining Chairs in Oak
23	Bar Table and Stools
24	Cloisters Seat, Court Seat, Border Seat
25	Watts Seat
26	Moat Bench
27	Wisley Woodland Seat, Reedback Seat
28	Broadwalk
30	Broadwalk Seats
32	Broadwalk Backless Benches
34	Broadwalk Seat Diagrams
36	Broadwalk Bench Diagrams

Page No.

Landscape Furniture

- 38 Broadwalk Tree Benches and Spirals
- 39 Broadwalk Tree Seats
- 40 Reedback Tree Seats

Also by Gaze Burvill

- 41 Occasional Tables in Oak
- 42 'A la Carte' Outdoor Kitchen
- 46 Custom & Bespoke
- 48 Accessories
- 49 Personalisation
- 50 Planters
- 51 Aftercare
- 52 Bowline Collection
- 56 Terms & Conditions





Craftsmanship

The skills of our master craftsmen lie at the heart of everything we make. Our workshop team draw on years of experience, brought up to date with leading edge modern technology.

Many of Gaze Burvill's best craftsmen start with us as apprentices, and as they often do, stay on with us to develop a deep understanding of the oak and the specific requirements of our designs.

Each craftsman puts his own mark on his finished piece and takes pride in the knowledge that it will give lasting pleasure to its owner for years to come.



Design Integrity

Design integrity is the yardstick by which Gaze Burvill measures everything it does.

We strive creatively to design our seats to provide optimum comfort and support. Our craftsmen ensure that they are hand built to the highest standard, providing outstanding performance for the long term.

Whether for the curve of a bench, the height and contours of a seat, or simply the dimensions of a table, we do our best to exceed expectations. We spend weeks, sometimes months, perfecting a design, from its overall aesthetic and practical form to its construction, fine detailing and tactile finish.



Sustainability

We use only oak from certified, sustainable woodland sources, with either FSC or PEFC certification. It comes predominantly from France, but also Germany and a growing proportion from England, as it becomes increasingly available.

Our state of the art premises are heated throughout by a modern bio-mass boiler fuelled by the company's production waste, and our electricity is supplemented by solar panels on the workshop roof.

Lodge Farm provides a setting that is fitting for our experienced team of talented designers and craftsmen whilst respecting the ecological standards we strive to achieve.

About our Oak

We only use oak, *Quercus robur* and *Quercus petraea*, sourced from certified sustainably managed European forests. Oak is widely recognised as one of the most durable temperate hardwoods. Our ancient ships and timber framed Tudor buildings are testimony to this fact.

The durability of oak comes from its extremely impermeable nature and its high tannin content. Tannin is a natural preservative and fungicide which is abundant in the heartwood of oak. We select trees between 100 and 150 years old as they provide timber which is naturally stable and durable. Over time the wood will develop a silver-grey patina.

An important feature of oak, and one that gives it great appeal to craftsmen, is the figured nature of its grain, in particular the medullary rays, but also 'cat's paw', 'pin knots', colour variations and the patterns around larger knots. These characteristics give each piece its own individuality and, as long as they do not affect its integrity, strength or durability, we have chosen to leave them in.

Once a piece of furniture is finished we expose it to ammonia in a process called 'fuming'. Fuming is an old cabinet maker's technique which darkens the oak, allowing the wood to age gracefully. While we have adopted fuming as the standard finish for all our oak furniture, other finishes are available on request.

Like all living materials oak will react to its environment. 'Checking' (small splits) may occur where the surface of the oak dries faster than its core. These may appear almost as soon as the furniture is put outside, and will open and close depending on the relative humidity.

Through careful attention paid at every stage of our process, from selecting timber from the most stable parts of the tree to properly seasoning it, and using time-tested construction methods, we can ensure that 'checking' is kept to a minimum, so that it will not affect the structure and longevity of our furniture.



Each Gaze Burvill piece carries the mark of the craftsman who made it.



Court Seat

Splash Lounge

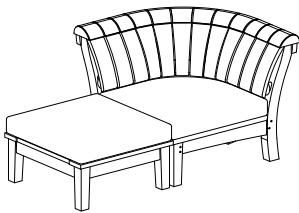

Luxurious, indulgent and contemporary in mood, Splash Lounge is perfect for urban and country terraces, and those outdoor-indoor spaces, which have become so much a part of desirable lifestyle. Versatile and on trend, the new Splash Lounge is a modular concept comprising of eight units. The steam-bent oak frame borrows its aesthetic from the original Splash, and provides outstanding strength and comfort, while the seats for Splash Lounge are lower and deeper than those of the original Splash (see pages following). QuickDry® foam cushions in canvas white 'Sunbrella®' outdoor fabric are provided as standard, but customers may specify their own fabric, for either outdoor or indoor use, as Splash Lounge works well indoors too.





SECCOL/R	Splash Lounge Corner Seat Left / Right	93 x 93 x 75	£ 6,300
SECCHL/R	Splash Lounge Corner Sofa Left / Right	184 x 93 x 75	£ 8,370
SECSTS	Splash Lounge Single Seat	68 x 93 x 75	£ 3,570
SECSTL	Splash Lounge Double Seat	136 x 93 x 75	£ 5,490
SECTS	Splash Lounge Ottoman	67 x 70 x 29	£ 1,980
SECTR	Splash Lounge Rectangular Table	136 x 70 x 29	£ 2,970

The heights listed above for Splash Lounge Tables and Chest refer to the oak items without cushions.
The height including cushions is 39cm.



Approximate dimensions are shown in centimetres,
and displayed: width/length x depth x height.

Visit our website www.gazeburvill.com for further ideas
or for any enquiries please call us on 01420 588444
© Gaze Burvill Ltd 2020 112020101

Splash



Seating

Splash is designed for outdoor living. Expansive, sculptural, and inviting, Splash is one of our most successful designs. Although comfortable without a cushion, all Splash seating comes with QuickDry® foam cushions upholstered in 'Canvas' Sunbrella® fabric as standard.



S21	Splash Armchair and cushion	116 x 81 x 80	£ 7,170
S22	Splash Short Sofa and cushion	172 x 81 x 80	£ 9,990
S23	Splash Long Sofa and cushion	220 x 81 x 80	£ 11,970



Tables and Chest

To complement the Splash Armchair and Sofas, we have designed a range of low tables. The storage chest will accommodate the largest cushions in this collection.

TS1	Splash Rectangular Table	148 x 82 x 40	£ 3,450
TS2	Splash Square Table	82 x 82 x 40	£ 2,370
SCB2	Splash Storage Chest	146 x 80 x 46	£ 8,370
	internal dimensions	131 x 65 x 31	



Approximate dimensions are shown in centimetres, and displayed: width/length x depth x height.

Visit our website www.gazeburvill.com for further ideas or for any enquiries please call us on 01420 588444
© Gaze Burvill Ltd 2020 112020101



Lizard Lounger



Lizard Lounger

Awarded a Design Guild mark from the Worshipful Company of Furniture Makers, the sleek and curvaceous design and its elegantly contoured construction provides excellent comfort with a choice of five angles of recline.

The carefully engineered three-layer cushion and headrest, made of QuickDry™ foam and upholstered in 'Canvas' (off-white) Sunbrella® fabric, comes as standard.

Discreet large-diameter wheels, ideal for moving over uneven ground, make the lounger easily manoeuvred around the terrace to catch the sun.

SLL01	Lizard Lounger and cushion	63 x 207 x 48	£ 3,990
-------	----------------------------	---------------	---------



Lizard Low Table

This compact table is the perfect complement to the lounger's sensuous and appealing curves. Specially designed to fit between two loungers it is the ideal place to keep drinks, paperbacks and suntan lotion just within arm's length.

SLT01	Lizard Low Table	55 x 42 x 34	£ 870
-------	------------------	--------------	-------

Approximate dimensions are shown in centimetres, and displayed: width/length x depth x height.

Visit our website www.gazeburvill.com for further ideas or for any enquiries please call us on 01420 588444

© Gaze Burvill Ltd 2020 112020101

King Lizard Lounger



King Lizard Lounger

Building on the success of our Lizard Lounger, we were inspired to create a sumptuous new super-size lounger: a generous place to share a podcast, crossword, early aperitif, a bask in the sun or just spread out and relax. Like the original Lizard, it is designed for ultimate comfort, sharing the same style of cushion and easily adjustable back-rest. All Loungers come with 'Canvas' (off-white) Sunbrella® fabric cushions as standard, or choose your own outdoor fabric for custom cushions.

SLK01

King Lizard and cushion

110 x 207 x 48

£ 5,970

Approximate dimensions are shown in centimetres, and displayed: width/length x depth x height.

Visit our website www.gazeburvill.com for further ideas
or for any enquiries please call us on 01420 588444
© Gaze Burvill Ltd 2020 112020101

Levity Tables & Chairs

Designed by Katie Walker, Levity is an elegant juxtaposition of technology and tradition, with beautiful dovetail joints offsetting high tech CNC machined twists. In response to a brief for an arrangement suitable for the rooftop terrace, chairs are light and easily moved, and tables can be combined in several ways. The oak structure offers the best of both worlds; ease of furniture movement blended with a structural integrity set to last against the elements.

The design concept of the chair was built around the interplay of two visually dominant parts: the front legs and armrest; and the back legs and backrest. These two parts are connected together by a stainless steel detail between the armrest and backrest. The table also explores the idea of two interlocking parts, where two arched leg sections come together to form a very strong combined 'T' leg section, with a table top made from UV-resistant and ultra strong Dekton® stone.

The prices below apply to tables with Dekton tops in the 'Group 1' range. For 'Group 2' Dekton tops, add 10%.

LVC01	Levity Chair	57 x 56 x 75	£ 1,170
LVT01	Levity 2 place Table	70 x 79 x 75	£ 1,680
LVT02	Levity 4 place Table	70 x 105 x 75	£ 1,920
LVT03	Levity 6 place Table	140 x 79 x 75	£ 2,520
LVT04	Levity 6 place large Table	140 x 105 x 75	£ 2,820
LVTD01	Levity D Table	140 x 79 x 75	£ 2,940



Approximate dimensions are shown in centimetres, and displayed: width/length x depth x height.

Visit our website www.gazeburvill.com for further ideas or for any enquiries please call us on 01420 588444

© Gaze Burvill Ltd 2020 112020101



Levity Chairs and Table

Oak Dining Tables



Mead

A substantial table softened by rounded ends, the Mead Table has no cross bars or corner legs to get in the way. For big occasions it is possible to join two Mead Tables together to form an even longer table. A parasol hole and cover can be added on request.

TM06	Mead 6 place Table	147 x 81 x 74	£ 4,470
TL08	Mead 8 place Table	173 x 96 x 74	£ 5,370
TN11	Mead 10/12 place Table	262 x 105 x 74	£ 6,870
TN12	Mead 12 place Table	305 x 105 x 74	£ 7,170
TN14	Mead 12/14 place Table	365 x 105 x 74	£ 9,990
FITPA	Parasol Hole and Cover		£ 120
TMJ	Mead Joining Piece; widths to suit tables		£ 480



Bailey

A pretty and practical table, the Bailey table's elegant pedestal base means no one has a bad spot when seated around the table. When used with a parasol the table frame doubles as the support for the parasol.

TB4	Bailey 4 place Table	107 x 107 x 74	£ 4,470
TB6	Bailey 6 place Table	127 x 127 x 74	£ 5,370
TB8	Bailey 8 place Table	152 x 152 x 74	£ 6,870
FITPAT	Parasol Hole, Cover, and Fitting Parasol to table		£ 240

Mead Tables, joined, with Chancery Chairs and Carvers





Oval Broadwalk Table with Broadwalk Seats and Benches

For seating, see from page 30 for Broadwalk Seats - with backs, and from page 32 for Broadwalk Benches - without backs.



Round Broadwalk

The radiating 'sunburst' pattern on Broadwalk tables emanate from a granite or oak centre-piece which rotates (as a Lazy Susan). The granite has a 'river washed' finish which gives it a lovely texture. It comes with a parasol hole as standard.

TBWR18	Broadwalk 1.8m Round Table 10 place	180 x 180 x 74	£ 11,970
TBWR21	Broadwalk 2.1m Round Table 12 place	210 x 210 x 74	£ 13,980

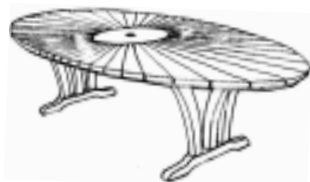

Oval Broadwalk

With all the qualities and features of the Round Table, the Broadwalk Oval also can be combined with Broadwalk Seats and Benches to create truly spectacular dining arrangements for a dozen or more people.

TBWO24	Broadwalk 2.4m Oval Table 8 place	240 x 150 x 74	£ 11,970
TBWO28	Broadwalk 2.75m Oval Table 10 place	275 x 150 x 74	£ 13,980
TBWO35	Broadwalk 3.5m Oval Table 12 place	350 x 150 x 74	£ 14,970
TBWO40	Broadwalk 4m Oval Table 14 place	400 x 150 x 74	£ 16,980



Cloisters

Originally designed to be used with our Cloisters and Court Seats, the Cloisters Table is one of our most distinctive pieces. The stone or oak centre comes pierced with a parasol hole as standard.

TCLT1	Cloisters Triangular Table 9/12 place	215 x 186 x 74	£ 11,970
-------	---------------------------------------	----------------	----------

Approximate dimensions are shown in centimetres, and displayed: width/length x depth x height.

Visit our website www.gazeburvill.com for further ideas or for any enquiries please call us on 01420 588444
© Gaze Burvill Ltd 2020 112020101

Occasional & Dining Chairs in Oak

Levity For Levity Chairs and Tables, please see page 18.



Chancery Chair & Carver

The Chancery Chair provides practical and comfortable seating for our dining tables. The Carver's arms give it extra gravitas, making it the chair of choice for the head of the table.

DC1	Chancery Chair	48 x 53 x 88	£ 990
DA1	Chancery Carver	69 x 56 x 88	£ 1,380



May Throne

Combining sculptural curves with comfort, the May Throne is one of our most versatile pieces, naturally suited to be an armchair, dining chair, or both. The 'Child's May Throne' is destined to become a treasured possession, particularly when carved with a name, or birth date. Our 'conversation seat', called 'Meander' is a unique addition to any outdoor space.

MA1	May Throne	85 x 64 x 88	£ 2,760
JMA1	Child's May Throne	60 x 45 x 62	£ 1,170
ME2	Meander Conversation/Love Seat	158 x 112 x 88	£ 4,770

Moat Stools A one-person size version of our Moat Bench (see page 26 for other sizes).

MOF	Moat Footstool	48 x 48 x 42	£ 930
MO1	Moat Stool	48 x 48 x 47	£ 990



Meander Conversation / Love Seat



A La Carte Bar Table and Stools



A la Carte Bar & Counter Stools

These two extremely comfortable elevated stools were shortlisted for an RHS Product of the Year at RHS Chelsea Flower Show. On the right is the 'A la Carte' Counter Stool - the perfect height for kitchen counters, and the taller stool on the left is the 'A la Carte' Bar Stool, at the traditional bar height, designed to accompany the Gaze Burvill Bar Table.

ALCBSL	A la Carte Counter Stool Seat height 67cm	43 x 40 x 80	£ 1,170
ALCBSH	A la Carte Bar Stool Seat height 77cm	43 x 40 x 90	£ 1,260

Bar Table

Perfect when partnered with Bar Stools, this table has a small footprint, so is ideal for small terraces and breakfast sun-traps.

ALCBT	A la Carte Bar Table	63 x 63 x 105	£ 2,370
-------	-----------------------------	---------------	---------

Oak Seats



Cloisters Seat

With Gaze Burvill's trademark steam-bent shaping and two back slats, this elegantly simple seat is equally at home in traditional or contemporary settings, as well as providing ideal seating for our Cloisters and Mead Dining Tables.

CL2	Cloisters Seat 2 seater	147 x 66 x 80	£ 3,480
CL3	Cloisters Seat 3 seater	178 x 66 x 80	£ 3,690
CL4	Cloisters Seat 4 seater	208 x 66 x 80	£ 3,930
CL5	Cloisters Seat 5 seater	254 x 66 x 80	£ 4,950

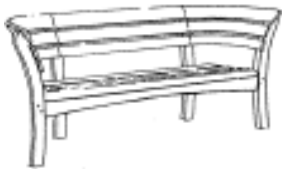

Court Seat

The Court Seat was designed in 1992, and perfectly embodies our ethos. It is designed to be sat "in" rather than "on", and works both as a solo piece or in conjunction with our dining and occasional tables.

CR2	Court Seat 2 seater	152 x 70 x 90	£ 4,380
CR3	Court Seat 3 seater	183 x 70 x 90	£ 4,620
CR4	Court Seat 4 seater	214 x 70 x 90	£ 4,920
CR5	Court Seat 5 seater	259 x 70 x 90	£ 5,880

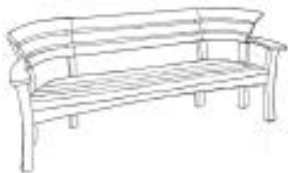

Border Seat

The Border Seat resulted from a commission by the RHS Gardens at Wisley. Its flowing, elegant design was recognised at its launch, and it was short-listed for the Wood Awards.

CB2	Border Seat 2 seater	145 x 71 x 90	£ 4,590
CB3	Border Seat 3 seater	175 x 71 x 90	£ 4,920
CB4	Border Seat 4 seater	206 x 71 x 90	£ 5,400

Oak Seats (continued)



Border Seat



Watts Seat

The Watts Seat was originally commissioned for the gardens of the Watts Gallery in Surrey. It draws its lines from a terracotta seat designed by Mary Seaton Watts, and was short-listed for an RHS Chelsea Flower Show Product of the Year.

SWG2	Watts Seat 2 seater	111 x 78 x 90	£ 6,300
SWG3	Watts Seat 3 seater	164 x 78 x 90	£ 7,950
SWG4	Watts Seat 4 seater	217 x 78 x 90	£ 8,970



Watts Seat

Approximate dimensions are shown in centimetres, and displayed: width/length x depth x height.

Visit our website www.gazeburvill.com for further ideas or for any enquiries please call us on 01420 588444
© Gaze Burvill Ltd 2020 112020101



Woodland Seat at RHS Wisley Garden in Surrey

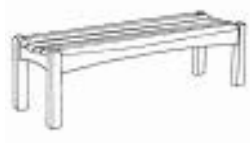

Moat Bench

An attractive and practical bench with a distinctive and comfortable contoured seat. Moat Benches are also available with a flat top to allow them to double as a table. 'One-person' versions of Moat Benches are also available - see page 22.

M02	Moat Bench 2 seater	135 x 48 x 47	£ 1,770
M03	Moat Bench 3 seater	163 x 48 x 47	£ 1,980
M04	Moat Bench 4 seater	194 x 48 x 47	£ 2,490



Moat Bench, Mead Table and Court Seat

Approximate dimensions are shown in centimetres, and displayed: width/length x depth x height.

Visit our website www.gazeburvill.com for further ideas or for any enquiries please call us on 01420 588444
© Gaze Burvill Ltd 2020 112020101

Oak Seats (continued)

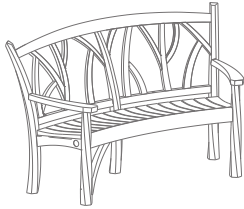

Woodland Seat

Gaze Burvill's Woodland Seat, craftsman-made from English Chestnut, has not a single 'straight' component. It showcases a masterful blend of state-of-the-art technology with traditional skills.

The twists which make the piece so unique echo the natural 'twist' in the trunk of the mature Sweet Chestnut tree.

WS02	2 seater	171 x 79 x 102	£ 6,960
WS04	4 seater	240 x 89 x 102	£ 7,920



Reedback Seat

The Reedback Seat design has complex curved elements along the back which were inspired by reeds swaying in the breeze. Reedback Seats also come as a curved seat or a treeseat. See page 40 for details.

Reedback is a confident, substantial piece, yet has a lightness of touch which only adds to its charms.

RBS14	Reedback 3 seater	150 x 78 x 90	£ 6,450
RBS18	Reedback 4 seater	186 x 78 x 90	£ 6,960
RBS22	Reedback 4 seater plus	223 x 78 x 90	£ 7,680



Reedback Seat

Broadwalk explained

Broadwalk modular design

We have designed the Broadwalk Collection so that any number of seats or benches can be combined to produce interesting and original shapes. Please note that Broadwalk Seats can only be combined with other seats, and Broadwalk Benches can only be combined with other benches.

Design Service

If you are interested in combining Broadwalk modular elements in your project, we can help map out the pieces that combine well for the space. Do send us drawings, or even a sketch or photo, with measurements and your requirements, and we can advise on which elements work best together.

Ordering Broadwalk

Broadwalk designs can be ordered in one of two ways:

- 1) All elements are made to be free-standing, allowing elements to be rearranged later, or
- 2) All elements are linked together, and will appear as single continuous item. This is ideal for large designs, such as Tree or Wave Seats.

Armrests

Armrests are optional on all Broadwalk seats, and if required, should be specified with the order. They can be added to either end of a Seat as well as wherever there is a rear leg. Typically, for pieces with arms, allowance should be made for up to an extra 12cm to be added to the length of the piece.

Broadwalk Curves and Radius Explained

The simplest way to understand the Broadwalk range is to think of the item as a slice of a circle. We produce different sizes of circle (radii) which you can take slices from (degrees):

360 degrees = full circle; 90 degrees = quarter circle, and so on.

The bigger the radius, the gentler the curve, and the smaller the slice required to fill a space.

Dimensions

The dimensions given for curving items are measured from tip to tip, as if the item were placed in a box, so that the dimensions would be the length x depth x height of the box. A very curved item (with a smaller radius) will have a smaller footprint than the measurements given.

Broadwalk Dimensions Explained

The code and description for Broadwalk Seats and Benches will give you the dimensions both the front radius and back radius, as well as the degrees of a circle.

For example:

B1690 3 seater Seat - radius 1.6m/0.9m - 90°

Approx. place numbers

Back Radius

Front Radius

Degrees of Arc



Broadwalk Seats



Straight Seats

Broadwalk Straight Seats provide a comfortable, substantial and refined solution for linear spaces, and are available with or without armrests.

BS12	2 seater Straight Seat 1.2m	125 x 71 x 90	£ 6,450
BS15	3 seater Straight Seat 1.5m	152 x 71 x 90	£ 6,960
BS18	4 seater Straight Seat 1.8m	180 x 71 x 90	£ 7,650



'Curving In' Seats

These versatile seats may form the focal point of a garden, or be placed with our Broadwalk Dining Tables. They are available with or without armrests and can be joined together with other Broadwalk Seats to create different shapes.

B0975	Throne (single chair)	117 x 74 x 90	£ 5,970
B1660	2 seater Seat - radius 1.6/0.9m - 60°	167 x 85 x 90	£ 7,500
B2042	2 seater Seat - radius 2.0m/1.3m - 42°	155 x 76 x 90	£ 7,500
B2828	2 seater Seat - radius 2.8m/2.1m - 28°	144 x 74 x 90	£ 7,500
B5414	2 seater Seat - radius 5.4/4.7m - 14°	140 x 71 x 90	£ 7,500
B1690	3 seater Seat - radius 1.6m/0.9m - 90°	230 x 100 x 90	£ 8,970
B2072	3 seater Seat - radius 2.0/1.3m - 72°	245 x 95 x 90	£ 8,970
B2844	3 seater Seat - radius 2.8/2.1m - 44°	217 x 90 x 90	£ 8,970
B3730	3 seater Seat - radius 3.7/3.0m - 30°	230 x 100 x 90	£ 8,970
B5420	3 seater Seat - radius 5.4/4.7m - 20°	245 x 95 x 90	£ 8,970
B9910	3 seater Seat - radius 10.5/9.8m - 10°	192 x 71 x 90	£ 8,970
B2090	4 seater Seat - radius 2.0/1.3m - 90°	293 x 107 x 90	£ 11,400
B2860	4 seater Seat - radius 2.8/2.1m - 60°	290 x 100 x 90	£ 11,400
B3745	4 seater Seat - radius 3.7/3.0m - 45°	288 x 91 x 90	£ 11,400
B5430	4 seater Seat - radius 5.4/4.7m - 30°	288 x 82 x 90	£ 11,400
B9915	4 seater Seat - radius 10.5/9.8m - 15°	284 x 76 x 90	£ 11,400



Broadwalk 'Curving Out' Seats

The unique shape of our Curving Out Seats means they can wrap closely, or loosely, around a feature or the trunk of a tree. Sculptural in nature, they are a strong feature to draw the eye in their own right.

BV0490	2 seater Seat - radius 0.36/1.0m - 90°	150 x 80 x 90	£ 6,990
BV0590	2 seater Seat - radius 0.47/1.1m - 90°	166 x 90 x 90	£ 8,280
BV0690	2 seater Seat - radius 0.64/1.3m - 90°	192 x 90 x 90	£ 8,670
BV1560	4 seater Seat - radius 1.5/2.2m - 60°	223 x 90 x 90	£ 9,900
BV3230	4 seater Seat - radius 3.2/3.9m - 30°	209 x 79 x 90	£ 9,900



Approximate dimensions are shown in centimetres, and displayed: width/length x depth x height.

Visit our website www.gazeburvill.com for further ideas or for any enquiries please call us on 01420 588444
© Gaze Burvill Ltd 2020 112020101

Broadwalk Backless Benches



Straight Benches

An adaptable backless bench whose carefully contoured seat makes it wonderfully comfortable.

BBS12	2 seater Straight Bench 1.2m	116 x 50 x 45	£ 3,480
BBS15	3 seater Straight Bench 1.5m	150 x 50 x 45	£ 3,960



Curved Benches

Broadwalk Benches can be made to different degrees of curvature, and can be joined together to fashion an intriguing variety of shapes.

BB0790	Corner single seater Bench	113 x 62 x 45	£ 2,970
BB1460	2 seater Bench - radius 1.4/0.9m - 60°	150 x 64 x 45	£ 3,960
BB2628	2 seater Bench - radius 2.6/2.1m - 28°	136 x 56 x 45	£ 3,960
BB5214	2 seater Bench - radius 5.2/4.7m - 14°	128 x 53 x 45	£ 3,960
BB1490	3 seater Bench - radius 1.4/0.9m - 90°	208 x 79 x 45	£ 4,800
BB1972	3 seater Bench - radius 1.9/1.4m - 72°	227 x 79 x 45	£ 4,800
BB2644	3 seater Bench - radius 2.6/2.1m - 44°	204 x 68 x 45	£ 4,800
BB5220	3 seater Bench - radius 5.2/4.7m - 20°	181 x 57 x 45	£ 4,800
BB2660	4 seater Bench - radius 2.6/2.1m - 60°	263 x 78 x 45	£ 5,760
BB9715	4 seater Bench - radius 9.7/9.2m - 15°	280 x 59 x 45	£ 5,760



Approximate dimensions are shown in centimetres, and displayed: width/length x depth x height.

Visit our website www.gazeburvill.com for further ideas or for any enquiries please call us on 01420 588444

© Gaze Burvill Ltd 2020 112020101



Broadwalk Benches and Seats provide seating for a Round Broadwalk Table, shown here with cushions.

Broadwalk Seat Diagrams

Plan drawings of Broadwalk Seats - scale 1:100

Please note that armrests are available on all Broadwalk Seats

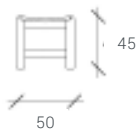
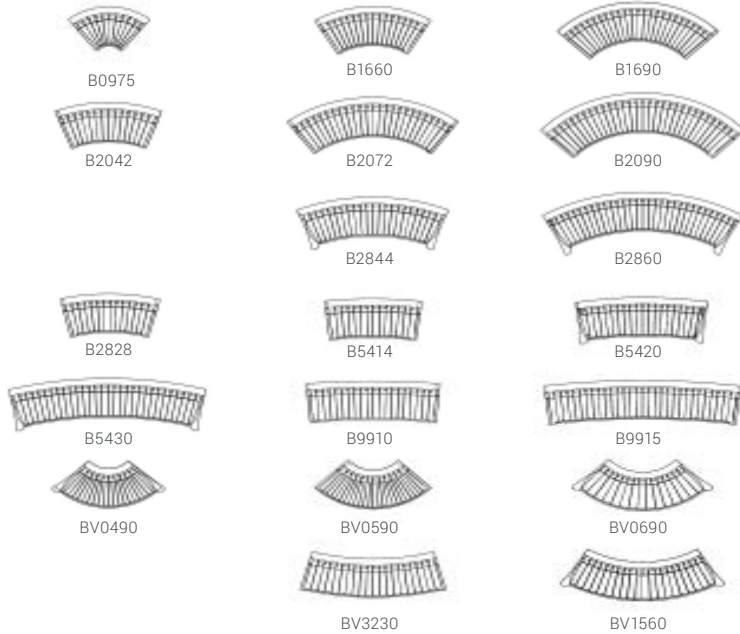

Broadwalk Bench

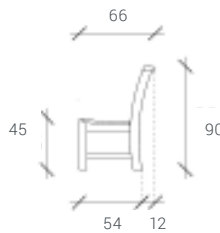

Broadwalk Seat

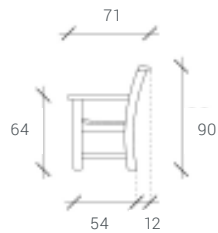

Broadwalk Seat with arms

Broadwalk Seat Suggestions

A selection of our most popular combinations:

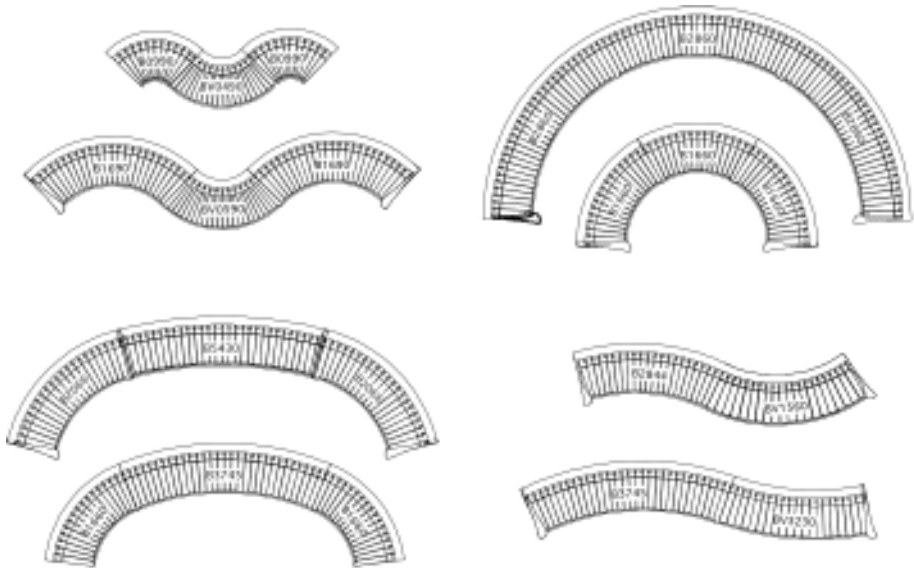

For Broadwalk Tree Seat information, please see page 39.



Broadwalk Straight Seats



BS12



BS15



BS18

Broadwalk Bench Diagrams



Plan drawings of
Broadwalk Benches

Scale 1:100



Broadwalk Bench
Section drawing

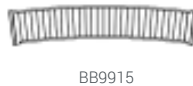
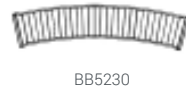

Broadwalk Bench Suggestions

A selection of our most popular combinations:

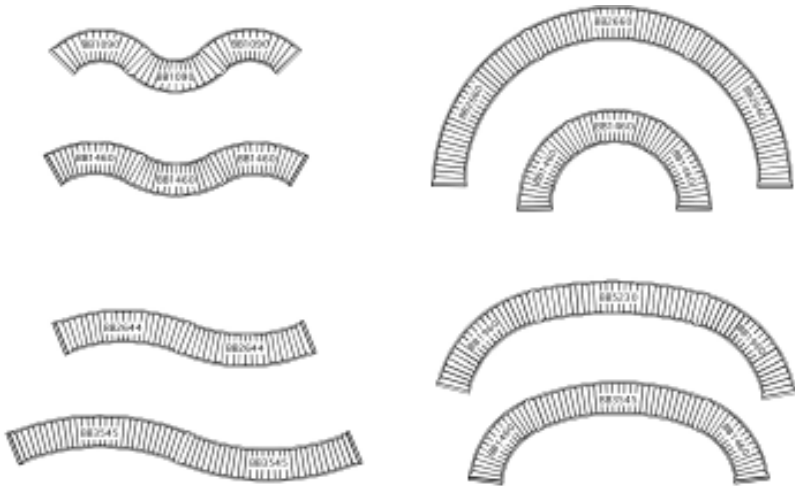

For Broadwalk Tree Bench and Spirals information, please see page 38.

Broadwalk Benches and Seats provide seating for a Round Broadwalk Table



Broadwalk Straight Benches



BBS12



BBS15



BBS18



BBS26

Broadwalk Tree Benches and Spirals



Broadwalk Tree Spirals

Broadwalk Tree Spirals are the true embodiment of the Broadwalk Collection. They are sculptural and inviting pieces, which can be used on their own or around a tree or planter.

BBTS05	Jubilee Spiral 0.5m Internal Diameter	228 x 176 x 45	£ 12,960
BBTS1	Spiral 1m Internal Diameter	340 x 234 x 45	£ 14,370



Broadwalk Tree Benches

Our circular Tree Benches are a lovely way to add a focal point to an attractive tree or sculpture, and can be constructed in a variety of sizes and shapes.

BBT05	Tree Bench 0.5m Internal Diameter	150 x 150 x 45	£ 10,770
BBT10	Tree Bench 1.0m Internal Diameter	200 x 200 x 45	£ 12,960

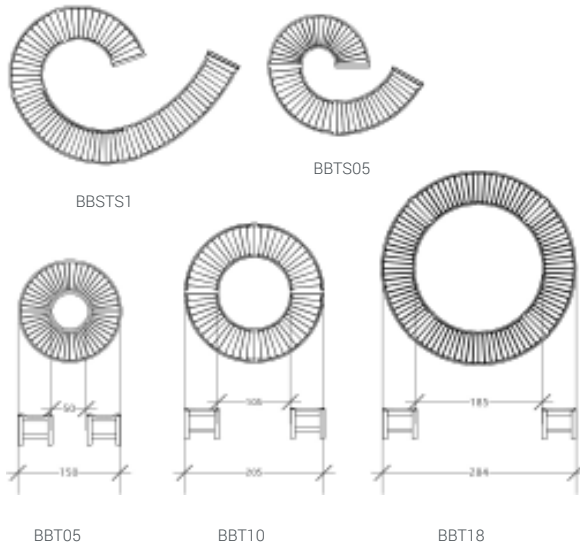

Approximate dimensions are shown in centimetres, and displayed: width/length x depth x height.

Visit our website www.gazeburvill.com for further ideas or for any enquiries please call us on 01420 588444
© Gaze Burvill Ltd 2020 112020101

Broadwalk Tree Seats



Broadwalk Tree Seats

These circular seats go beautifully around a tree, sculpture, planter or other garden feature. The backrest on Tree Seats curves backwards to provide greater comfort. This means that Tree Seats have an internal diameter 24cm larger at the base than the diameter given.

BVT07X	Tree Seat 0.7m Internal Diameter	200 x 200 x 90	£ 23,970
BVT10W	Tree Seat 0.94m Internal Diameter	225 x 225 x 90	£ 27,840
BVT130W	Tree Seat 1.28m Internal Diameter	260 x 260 x 90	£ 29,970

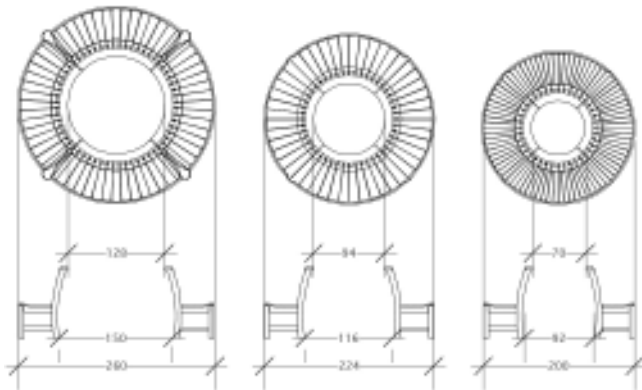

BVT130
shown with arms

BVT10

BVT07



Broadwalk Spiral Bench

Reedback Tree Seats



Reedback Tree Seat

The Reedback design works particularly well in a tree seat format, as well as for simple seats (see page 27).

A Reedback Tree Seat is a confident, comfortable piece, but shares a refreshingly light stance with the other seats in the Reedback family.



RBVT07	0.74m internal diameter Tree Seat	£ 19,980
RBVT10	0.97m internal diameter Tree Seat	£ 22,740
RBVT13	1.31m internal diameter Tree Seat	£ 23,970



Occasional Tables in Oak



Court

Available as an oval occasional table or in a slightly taller round side table, Court Tables go particularly well with May Thrones, Border, Court and Cloisters Seats.

TC1	Court Low Oval Table	112 x 70 x 46	£ 1,470
TC2	Court Low Round Side Table	58 x 58 x 52	£ 1,170

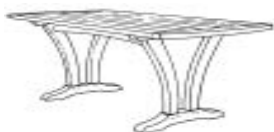

Mead Low Table

A more substantial rectangular low table, the Low Mead's slightly taller height makes it perfect for casual entertaining and 'club' style dining. Mead tables in a variety of sizes are also available at 'dining' height (74cm).

TML06	Mead Low Table	147 x 81 x 55	£ 3,480
-------	----------------	---------------	---------



Bailey Low Table

The Bailey table is the perfect accompaniment to our May Thrones. Its slightly taller height makes it perfect for casual entertaining and 'club' style dining. Bailey tables in a variety of sizes are also available at 'dining' height (74cm).

TBL4	Bailey Low Table	107 x 107 x 57	£ 3,480
------	------------------	----------------	---------



Splash

These two occasional tables and the chest, are part of the elegant and luxurious Splash Collection, The chest doubles as a low table that provides generous outdoor storage space.

TS1	Splash Rectangular Table	148 x 81 x 40	£ 3,450
TS2	Splash Square Table	81 x 81 x 40	£ 2,370
SCB2	Splash Storage Chest	148 x 81 x 46	£ 8,370
	internal dimensions	131 x 65 x 31	

'A la Carte' Outdoor Kitchen

A la Carte opens the door to an entirely new level of outdoor cooking experience. Gaze Burvill's innovative, versatile and craftsman-made outdoor kitchen collection features a range of superb appliances specified for outside use, with beautiful, precision-built oak cabinets for them to sit in. Teppanyaki or BBQ grill, side burner, fridge, ceramic oven, warming drawer, bar extensions, up-stands, counter top, in-drawer and in-cabinet lighting, stainless steel fixings and a beautiful fumed finish are just some of the elements that make up A la Carte.

As well as a varied range of standard modular pieces, our in-house design team and craftsmen can work with customers on unique, bespoke installations and adaptations, creating exactly the kitchen required for the individual outdoor space, for the family terrace or the professional outdoor space.

Now available with a choice of 'Linear' or 'Vertical' cabinet styles, there is a perfect 'A la Carte' kitchen for every setting, either contemporary or traditional. A la Carte offers options which are adaptable, up-datable, even re-locatable.

All Gaze Burvill cabinetry is made from certified, sustainably sourced wood from known sources. Please contact our sales team for further information, pricing and design specifications.





Visit our website www.gazeburvill.com for further ideas
or for any enquiries please call us on 01420 588444



'Linear' style of A la Carte kitchen



'Vertical' style of A la Carte kitchen



'A la Carte' Outdoor Kitchen (continued)

Today we embrace an approach more engaged with the outdoors, to gather friends and family around us, to enjoy preparing and sharing food together, but with the same aesthetic expectation, not to mention requirement for kitchen equipment and accessories, that we have of the kitchen inside the house.



Grill Station

The 'Grill Station' is the latest addition to Gaze Burvill's 'A la Carte' outdoor kitchen collection, and provides exquisite oak cabinetry for a choice of grill or cooking appliance, a small fridge, worktop, and plenty of storage. On lockable wheels, the Grill Station is an adaptable, moveable craftsman-made mini-kitchen – perfect for terraces large or bijou.

A la Carte uses materials that are second to none in performance and quality: sustainably grown and certified prime-grade oak, Dekton® worktops, performance hinges and a wealth of hidden detailing - and an inspiring choice of excellent outdoor-specification appliances.

Custom & Bespoke

Being both 'Designers' and 'Makers' allows us to make custom alterations to individual pieces from our collections with ease, and also produce unique, bespoke, site-specific designs to a brief.

Gaze Burvill has a large diverse collection to suit numerous requirements, however we understand the importance of 'a good fit'. We can adjust dimensions and detailing according to the requests of clients or the requirements of a particular outdoor space. These are 'custom' items.

In addition to this, Gaze Burvill has acquired a unique hands-on experience and understanding of designing and making outdoor furniture for the individual garden or terrace setting. Our established in-house design service, state of the art manufacturing capability and experienced team of craftsmen mean that we welcome a diversity of outdoor projects: special, ambitious and challenging.



Pricing for Bespoke Pieces

Any initial consultation is free of charge. Thereafter, a bespoke project will be progressed in stages, in close dialogue with the customer, with payments required for each of the stages. Generally these are:

- Concept stage
- Prototyping stage (where required)
- Full design and workshop specifications
- Making the finished piece



'Remembrance & Hope', a bespoke seat to commemorate the centenary of the end of WWI, specially commissioned by Royal Botanic Gardens, Kew.





DRAFT PROPOSAL FOR DISCUSSION

Haverford College Outdoor Classroom at the Hampshire Workshop, before being shipped to the USA



Haverford College Outdoor Classroom now in situ at Haverford College, Pennsylvania USA



Accessories



A cantilevered Tuuci parasol, which has been tested in high winds from the Californian Pacific coast, provides elegant shade.

Parasols

We supply a range of resilient, elegant modern parasols with stainless steel frames. Choose from several anchoring or cantilever options, as well as built-in heaters. Contact the Sales Team for further details and prices.

Cushions and Covers

A wide variety of outdoor-rated cushions and covers are available in standard or custom colours, or can be made with a customer's own fabric on request. Contact the Sales Team for further details and prices.



Personalisation

From time to time, a piece of Gaze Burvill furniture is more than just a piece of furniture. It might be a gift or memento to celebrate a special event, or memory of someone. It is a wonderful way to mark an occasion.



Carving & Plaques

We can add a beautiful hand-carved inscription or design to almost any of our pieces. We work with skilled carvers who can add something as simple as a name, to a line of poetry, a family crest or personal sign, and also employ digital technologies where that is appropriate. Please enquire about options for personalising your furniture choice.



Leg Height Adjustors, Security Fixings and Anchoring

We advise preventing our furniture from prolonged contact with wet surfaces. To aid this, we fit plastic feet to all our furniture as standard. For particularly large items we fit adjustable feet which also allow for a 2cm height adjustment.

For situations where the ground is uneven we provide two types of stainless steel height adjusters which provide either 5cm or 15cm of height adjustment. These are ideal in situations where the ground will be graduated around a substantial piece of furniture. The adjuster is supplied as standard on Broadwalk Tree Seats and our larger pieces.

Sometimes it is necessary to anchor oak furniture for security reasons. We provide two types of leg anchor, depending on whether the furniture is to be secured into a soft surface, such as a lawn, or a hard surface such as paving. In both instances the furniture is secured using security screws allowing for future access.

Planters



We make a large range of lined standard oak planters to order, and also custom, bespoke ones, with removable panels, wheels, and other details. Please enquire about desired dimensions.

Bespoke moveable Broadwalk Planter



Aftercare

Care and Maintenance

Gaze Burvill furniture is crafted from prime, quarter-sawn, sustainable Oak. Sourced from trees which stood for over a hundred years, with proper care, it can retain its beauty and resilience for years to come.



As a natural material, exposed to the elements, wood will change in appearance. Weathered oak will develop a beautiful silver-grey patina, which will highlight the grain patterns unique to oak, one of many features which makes this beautiful material such a good choice for furniture for outdoors. Basic care required is minimal - a wash with a scrubbing brush and detergent such as sugar soap usually once a year, depending on where it is located.

Brand new oak furniture will leach tannin the first few times it is exposed to rain. Tannin marks on furniture and pale paving will disappear over time, and rinsing surfaces immediately after a rainfall will greatly reduce any temporary marking.

Oak is naturally durable and impermeable and thus will normally repel water, however, we recommend you do not allow oak furniture to rest in standing water or damp soil for prolonged periods. As oak ages, it gradually loses this natural impermeability which protects it from trapped moisture and dirt. Left unmaintained, water and fungi may penetrate through small gaps in the grain, which in the worst cases, can lead to localised rot. After 4-8 years of exposure, depending on its location, we recommend replenishing the natural oils of the oak with a specialist water-repellent penetrating oil. This will give the oak back its impermeability, and allow it to dry off faster and make it easier to keep clean. Gaze Burvill can supply the product for you to apply, or we can do it for you as part of our 'Aftercare Service'.

Bowline

For Bowline, a wash with a solution of pure soap flakes and warm water and a rinse in fresh clean water is all that is normally required for our stainless steel collection and Sunbrella® fabrics. Like all stainless steel in marine locations (salt water atmospheres), cleaning in these areas will need to be more frequent and use of stainless steel cleaners may be required.

Aftercare Service

Signing up to our Aftercare Service for the peace of mind that your furniture is in great condition and looking fabulous for years to come. The team is always ready to offer advice on how to best maintain your furniture. Please do contact us with any questions you have.



The original Broadwalk Seat at RHS Wsley in Surrey.



The Bowline Collection was developed to meet the exacting standards of the Superyacht industry. Every piece of the collection has been designed to give the best performance and the highest possible level of comfort. Its nautical origins ensure that seats and loungers are quick and easy to stack and fold, yet all Bowline pieces are substantial enough to withstand the toughest environments.

The designs work perfectly by the most elegant pool, on the smartest roof terrace or aboard the most stylish yacht.

The Best Materials

- 316 Marine Grade Stainless Steel, shot peened to produce a matt finish, both tactile and durable.
- Waterproof Spinneybeck® Leather, hand stitched onto the armrests of the Chairs and Recliners.
- Sunbrella® outdoor fabric, solution-dyed acrylic, fade resistant, machine washable, luxuriously soft.
- Toughened Glass with an acid-etched top, anti-glare and scratch-resistant, coated with a water repellent treatment to prevent streaking.

Bowline Lounger

The first design created for Bowline, the sun lounger adjusts to 5 positions, allowing you to sit up and read or to lie on your front. Conveniently, the Loungers can be stacked up to 6 high.



LB01 Bowline Lounger

206 x 72 x 120

£ 2,580



Bowline Recliner and Foot Stool

With four reclining angles, so you can effortlessly find your ideal pool-side position.

The Recliners can be stacked up to 5 high.

LB02

Bowline Recliner

100 x 73 x 120

£ 1,980

LB03

Bowline Foot Stool

59 x 58 x 45

£ 600



Bowline Low Round Table

An elegant little table, perfect to accompany the Bowline Lounger or Recliner.

LB06G

Bowline Low Round Table

50 x 50 x 46

£ 600



Bowline Recliner and Footstool

The Bowline Collection



Bowline 4 Place Square Table

The table can be assembled and disassembled in seconds without the need for tools, and all of the components can be stored compactly.

LB05G2 Toughened acid etched glass, 100 x 100 x 73 £ 1,950
40mm parasol hole & cover

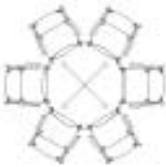

Bowline 6 Place Round Table

The table can be assembled and disassembled in seconds without the need for tools, and all of the components can be stored compactly.

LB05G3 Toughened acid etched glass, 130 x 130 x 73 £ 2,450
40mm parasol hole & cover



Bowline Yacht Chair

Designed with an innovative folding mechanism which allows them to be hung on a wall rack or stacked on the floor, perfect for when you need a spare chair. Winner of the BIDA Award for Outstanding Design and Innovation.

LB10 Bowline Yacht Chair - stackable up to 6 high 69 x 60 x 84 £ 1,260



Bowline Low Back Dining Chair

A comfortable dining chair, ideal for casual settings.

LB09 Low Back Dining Chair - stackable up to 6 high 68 x 65 x 84 £ 960



Bowline High Back Dining Chair

The ideal chair to create a sense of grandeur.

LB04 High Back Dining Chair - stackable up to 4 high 68 x 65 x 114 £ 1,140



Weather Resistant Covers

In waterproof breathable fabric with taped seams and a 'weighted hem'.

LBC014	Cover for up to 4 Bowline Loungers	
LBC023	Cover for up to 3 Recliners, or 2 with Footstools	
LBC043	Cover for up to 3 High Back Dining Chairs	
LBC046	Cover for up to 6 High Back Dining Chairs	
LBC093	Cover for up to 3 Low Back Dining Chairs	
LBC096	Cover for up to 6 Low Back Dining Chairs	POA

Approximate dimensions are shown in centimetres, and displayed: width/length x depth x height.

Visit our website www.gazeburvill.com for further ideas or for any enquiries please call us on 01420 588444

© Gaze Burvill Ltd 2020 112020101

Terms & Conditions

1. Prices are valid for 30 days from the date of written quotation unless otherwise specified on the quotation itself.
2. Prices quoted are with VAT shown separately where applicable.
3. Delivery charges will be shown as a separate item on quotations and, if not shown, then the price quoted will be Ex Works.
4. Lead Times for our work are typically 4-8 weeks. We will provide you with an accurate lead time once we have received your deposit and, for custom and bespoke orders, your signed Design Approval Drawing.
5. For export, instructions for installation will be provided, the cost of crating and shipping and overseas installation is available on request (payable in addition). Any importation duties, taxes or other levies on importation are the responsibility of the purchaser.
6. A 50% deposit is due on placement of all orders of furniture and manufactured items.
7. Full payment is required for any bought in items, such as cushions, parasols, and kitchen appliances.
8. Any bank charges for international payments must be paid for by the client.
9. All deposits are nonrefundable once the order confirmation has been issued to the purchaser.
10. The balance of monies is due 2 weeks prior to the delivery due date and in all cases prior to any goods being shipped.
11. If the purchaser is unable to take delivery within 1 month of being notified that the product is ready for installation or despatch then the balance of the sales price will become payable one month after such notification and the purchaser will subsequently incur storage charges at Gaze Burvill Limited's standard weekly storage rate tariff.
12. All custom and bespoke designs information must be confirmed by signing and dating the Design Approval Drawing. If the purchaser does not supply design approval within 12 months of the order being placed the balance of the sales price will become due. Should any change be required after the Design Approval Drawing has been signed and once the item has gone into production, Gaze Burvill Limited will make a charge for any changes.
13. If there is any other failure on the purchaser's part which prevents the delivery within 12 months of the order being placed the balance of the sales price will become due.
14. Any amendments made to the technical drawings after the Design Approval Drawing has been signed will be charged at our standard hourly labour rate.
15. Finishes, engraving, fixtures and additional features, where required, should be advised at the point of sale and will be confirmed on the order confirmation.
16. All products supplied remain the property of Gaze Burvill Limited until payment has been received in full. The purchaser grants to Gaze Burvill Limited its employees and agents an irrevocable licence to enter any premises where the goods are stored, installed or believed to be, for the purposes of retaking possession of the product(s).
17. In the event of payment not being received by the due date, interest may be charged from the due date on any outstanding balance until the payment is made in full.
18. Samples of material that may affect the performance of Oak used in the production of the furniture or kitchens should be provided for testing. Gaze Burvill Limited will not be held responsible for any staining, discolouration if materials are not provided beforehand for testing.
19. It is the client's responsibility to prepare the site for installation in accordance with the recommendations of Gaze Burvill Limited. Should the site not be prepared as specified and as a result of this additional work is required by Gaze Burvill Limited or the installation is delayed, then Gaze Burvill Limited will charge for any additional labour at the standard labour rate, mileage and materials required. Gaze Burvill Limited will advise on site preparation but will not be responsible for any work conducted by a third party in this regard.
20. In the event that the site has not been prepared in accordance with the Gaze Burvill Limited specification, and in the opinion of a Gaze Burvill Limited employee is unsuitable for installation of the product(s), Gaze Burvill Limited reserves the right to charge for a wasted site visit.
21. Mileage where applicable will be charged per mile. Labour and travelling time will be charged at the standard labour rate per operative including travelling time where applicable.
22. On the installation of certain products additional labour may need to be provided by the client and this will be indicated at confirmation of order.
23. Gaze Burvill Limited will not be responsible for any damage caused by any person other than in its employ and will not be responsible for injury sustained by any third party.

24. Gaze Burvill Limited is committed to the promotion of health and safety and proper regard for the environment in respect of all its activities. In circumstances where Gaze Burvill Limited issues health and safety data sheets for commissions, the purchaser shall be responsible for ensuring that its employees, contractors and users read and observe the instructions and recommendations in them.
25. All kitchen electric service panels have been assembled by a PAT qualified craftsman in our workshop. The final connection on site must be arranged by the client and must be undertaken by a NIC EIC qualified electrician or GAS SAFE registered installer who will need to provide the purchaser with an installation certificate. Failure to obtain an electrical installation certificate will invalidate the warranty.
26. On receipt of the client's signed Design Approval Drawing and Deposit, best endeavours will be made to ensure the delivery of the products within the specified timeframe. Gaze Burvill Limited cannot be held responsible for delaying factors outside their control.
27. In the event of a shipment being received damaged, please sign the delivery paperwork as damaged. If delivery crates are used, under no circumstances discard the crate. Report and damage to the delivery team as soon as possible and before use. Photos of the damaged items and any relevant packaging need to be sent promptly to Gaze Burvill Limited. Failure to comply with any of the above procedures will invalidate your guarantee.
28. We warrant our oak furniture, 'A la Carte' cabinetry and the stainless steel frames of our Bowline furniture, to the original owner to be free from defects in materials and workmanship for 10 years, apart from our Oak Planters, Levity furniture and Woodland Seats, which carry a warranty of 5 years. We warrant all other items including upholstery, parasols, and covers for 12 months from the date of purchase. Appliances for 'A la Carte' are subject to their manufacturers' guarantees. This warranty is for residential use only, is not transferable and is limited to repair or replacement at our sole discretion. Claimed defective items must be returned to us prepaid. We specifically disclaim warranties of merchantability or fitness for a particular purpose. This warranty does not apply to damage resulting from improper maintenance, misuse, negligence, accidents, abuse or exposure to extreme climatic conditions. For information regarding all commercial warranties, kindly contact our sales office.
29. Where appropriate, Gaze Burvill Limited will supply a maintenance schedule. Gaze Burvill Limited will not be responsible for any failures which in Gaze Burvill Limited's opinion results from untimely or poor maintenance. Such untimely or poor maintenance will invalidate the warranty.
30. Gaze Burvill Limited will manufacture all products in accordance with their appropriate use and does not accept responsibility for any failure of a product resulting from negligence, vandalism, inappropriate or unreasonable use, incorrect installation or, with respect to large custom and bespoke items and kitchens, the product being moved other than by Gaze Burvill Limited employees or appointed representatives.
31. Because of the natural nature of our products and the processes employed in their manufacture, there may be minor colour variations between product supplied, samples and illustrations.
32. This agreement shall be governed by and construed in accordance with English law. Each of the parties irrevocably submits for all purposes in connection with this agreement to the exclusive jurisdiction of the courts of England.
33. Gaze Burvill Limited will not be responsible for natural processes such as weathering, oxidation and staining which may change the colour of materials over time.
34. All Intellectual Property Rights, design rights and the like including drawings, renderings or illustrations shall be and remain property of Gaze Burvill Limited and the purchaser shall not be entitled to or claim, and shall procure that its affiliates, associates, agents and buyers from the purchaser do not claim ownership of any such Intellectual Property Rights. Nothing in this agreement shall give the purchaser, its affiliates, associates, agents or buyers from the purchaser any proprietary interest in the designs which cannot be copied without the consent of Gaze Burvill Limited
35. The purchaser agrees that the designs will be used by the purchaser in the form in which are received and, in particular, without addition, adulteration, alteration or contamination of any kind whatsoever. The purchaser further agrees not to alter the visible design of the items in any way or to remove, obliterate or otherwise deface the Gaze Burvill Limited marks appearing thereon.
36. The purchaser agrees that this agreement cannot be considered as a transfer of design rights, IP rights, branding rights, trademarks or copyright held by Gaze Burvill Limited
37. On accepting these terms and conditions, Gaze Burvill Limited have the right to use any images in social media, unless the purchaser has advised otherwise in writing.
38. Any indemnity or relief from or limit of liability in favour of Gaze Burvill Limited shall extend to and apply for the benefit of their respective directors, employees and authorised agents.

Original Designs

Our in-house design team is dedicated to creating new designs, and customizing our existing collections, so that Gaze Burvill customers can be assured of finding the perfect solution for an individual project. Our experienced and specialist craftsmen and designers work from the same location, providing a seamlessly integrated design process.

The Gaze Burvill Collections, unique in their comfort, style and visual impact, have been built up over the years working with some exceptional designers:

- Christian Gaze, a founding partner of Gaze Burvill, designed our initial collections, which include the Court and Cloisters Seats, the May Throne and Meander and Mead, Bailey, Court and Cloisters Tables. He more recently designed the Splash Collection for us and continues to have an important design influence.
- Tim Royall designed the original Broadwalk Seating System as well as the Broadwalk Dining Tables in conjunction with Simon Burvill.
- From the Bowline Collection, the Lounger, Recliner, Foot Stool and Tables are original designs created by Christian Gaze. The High Back Dining Chair, Low Back Dining Chair and Yacht Chair were created by Simon Burvill in collaboration with Christian Gaze from an original concept by Alan Rodford.
- Levis was designed by award-winning designer Katie Walker, to be a chair and table collection for smaller terraces, balconies and rooftops.

We reserve the right to change specifications and prices of our products without notice. All our designs are original copyright works and protected worldwide. We are members of the international organization ACID (Anti Copying in Design). Bowline, and all the names of our oak products are Trade Marks and our designs are Registered Designs.

What people say about us...

"it will give a tremendous amount of pleasure to all who use it!

Many thanks to all involved - a great job and delight to all here."

Jackie Dawson, Private customer

**"Sitting on the bench this afternoon one can understand the workmanship,
how they bend the oak the way they do is very impressive indeed."**

Kim de Morgan, Private customer

**"I must say, seeing the bench in reality, it was very beautifully made - our set
builders were so impressed with how the wood was moulded."**

Miranda Sinclair, Senior Editorial Stylist

The World of Interiors

**"Gaze Burvill furniture is for
people who enjoy the quiet
pleasure of owning pieces of
lasting quality and beauty."**

Simon Burvill



Gaze Burvill Ltd, Lodge Farm
East Tisted, Hampshire
GU34 3QH

01420 588444
info@gazeburvill.com
www.gazeburvill.com



GAZE BURVILL



GAZE BURVILL

Lodge Farm, East Tisted, Hampshire, GU34 3QH
01420 588444 info@gazeburvill.com

www.gazeburvill.com