

AC INFINITY

# **ADVANCE GROW SYSTEM**

## **COMPLETE INDOOR PLANT KIT**

**USER MANUAL**



# PROUD TO PRESENT TO YOU THE ADVANCE GROW SYSTEM

Thank you for choosing AC Infinity. As growers, we've dreamt of applying commercial levels of automation technology to our systems, scaled down for home growing, without the commercial level price tag. Now we've made it possible.

This complete indoor growing system is the culmination of four years of development, implementing smart controls into all the technology a grow space uses to create a fully automated system. Each grow tent kit contains equipment that is collectively rated to grow your desired number of plants and can be controlled using its grow tent controller or the AC Infinity app.

We are committed to product quality and friendly customer service, so please [contact](#) us if you have any questions or suggestions. Don't forget to share your growing journey with this complete indoor growing system on social media [@acinfinityinc!](#)

## EMAIL

[support@acinfinity.com](mailto:support@acinfinity.com)

## WEB

[www.acinfinity.com](http://www.acinfinity.com)

## LOCATION

Los Angeles, CA

## MANUAL CODE PK2210X1

### PRODUCT

Advance Grow Tent Kit (2x2) COMPACT  
Advance Grow Tent Kit (2x2)  
Advance Grow Tent Kit (2x4)  
Advance Grow Tent Kit (3x3)  
Advance Grow Tent Kit (4x4)  
Advance Grow Tent Kit (5x5)

### MODEL

AC-PKA22  
AC-PKB22  
AC-PKB24  
AC-PKB33  
AC-PKB44  
AC-PKB55

### UPC

819137022829  
819137022836  
819137022843  
819137022850  
819137022867  
819137024038

# MANUAL INDEX

- Manual Index ..... Page 5**
- Product Warning ..... Page 7**
- Product Contents ..... Page 8**
- Quick Build Guide ..... Page 10**
  
- CLOUDLAB: Advance Grow Tent ..... Page 12**
  - Product Contents ..... Page 13
  - Tent Setup ..... Page 15
  - Controller Plate Setup ..... Page 20
  - Mounting Guide ..... Page 22
  - Ventilation Guide ..... Page 23
  - Configuration Setup ..... Page 24
  
- CLOUDLINE: Mixed Flow Inline Fan System ..... Page 26**
  - Product Contents ..... Page 27
  - Mounting ..... Page 28
  - Overhead Hanging ..... Page 33
  - Motor Cap ..... Page 36
  - Configuration Setup ..... Page 37
  - Cleaning ..... Page 38
  
- Duct Carbon Filter: Premium Australian Charcoal ..... Page 40**
  - Product Contents ..... Page 41
  - Installation ..... Page 42
  - Overhead Hanging ..... Page 43
  - Configuration Setup ..... Page 47
  - Maintenance ..... Page 50
  
- IONBOARD / IONFRAME EVO: Grow Light System ..... Page 52**
  - Product Contents ..... Page 53
  - Installation ..... Page 55
  - Driver Mounting: IONFRAME EVO ..... Page 57
  - Overhead Hanging ..... Page 60
  - Powering and Setup ..... Page 63
  - Starter Guide ..... Page 65
  - Programming ..... Page 67

# MANUAL INDEX

<b>CLOUDRAY: Oscillation Fan System</b> .....	<b>Page 68</b>
Product Contents .....	Page 69
Recommended Usage .....	Page 70
Installation .....	Page 71
Cleaning .....	Page 74
Programming .....	Page 76
<b>CONTROLLER 69 PRO: UIS™ Controller</b> .....	<b>Page 78</b>
Product Contents .....	Page 79
Powering and Setup .....	Page 80
Mounting .....	Page 82
UIS™ Platform .....	Page 84
UIS™ Compatibility .....	Page 85
Adding More Devices .....	Page 86
Programming .....	Page 88
Other Settings .....	Page 112
Download the App .....	Page 113
Add a Device .....	Page 114
Frequently Asked Questions .....	Page 121
<b>Warranty</b> .....	<b>Page 124</b>

# PRODUCT WARNING



TO REDUCE THE RISK OF FIRE, ELECTRIC SHOCK, OR INJURY TO PERSONS, OBSERVE THE FOLLOWING:

1. Ensure your power source conforms to the electrical requirements of this product.
2. Check your local code restrictions for additional safety measures that may be needed for a proper code compliant installation.
3. Read all instructions before installing and using this product.
4. If you are unfamiliar or have doubts about performing this product's installation, seek the services of a qualified, trained, and licensed professional. Inappropriate installation will void this product's warranty.
5. Do not attempt to hardwire this product. Performing any retrofitting actions may result in personal injury and/or electrical damage, and will void this product's warranty.
6. This product must not be used in potentially hazardous locations such as flammable, explosive, chemical-laden, or wet atmospheres.
7. Ducted products must always be vented to outdoor areas.
8. Do not cover power cords with rugs or other fabric materials.
9. This product has rotating parts. Safety precautions should be exercised during the installation, operation, and maintenance of this product.
10. Do not insert or allow fingers or foreign objects to enter any ventilation or exhaust openings as it may cause electric shock, fire, or damage to this product. Do not block or tamper with this product in any manner while it is in operation.
11. Do not depend on the on/off programming as the sole means of shutting power from this product. Unplug the power cord before installing, servicing, or moving this product.
12. Do not operate this product while its cord is damaged, or if it malfunctions, has been dropped, or is damaged in any manner.

# PRODUCT CONTENTS

## OVERVIEW

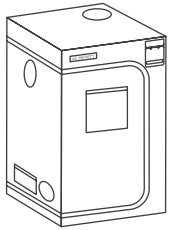

CLOUDLAB  
Advance Grow Tent  
**BOX A**

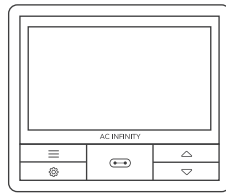

CONTROLLER 69 PRO  
UIS Controller  
**BOX B**

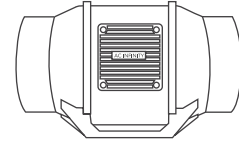

CLOUDLINE  
Inline Fan  
**BOX C**  
(NOT included in AC-PKB55)

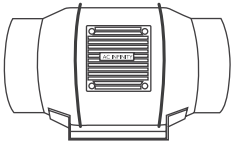

CLOUDLINE PRO  
Inline Fan  
**BOX C**  
(ONLY included in AC-PKB55)

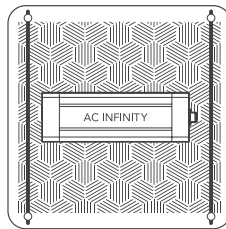

IONBOARD  
LED Grow Light  
**BOX D**  
(NOT included in AC-PKB55)

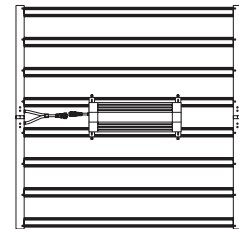

IONFRAME EVO  
LED Grow Light  
**BOX D**  
(ONLY included in AC-PKB55)

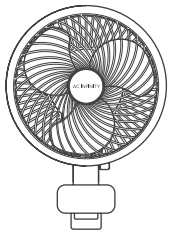

CLOUDRAY  
Clip Fan  
**BOX E**

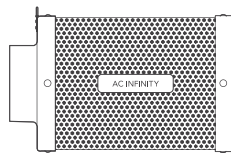

INLINE  
CARBON FILTER  
**BOX F**

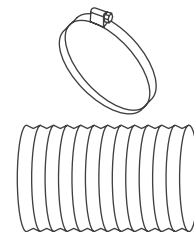

DUCTING  
AND CLAMPS  
**BOX G**

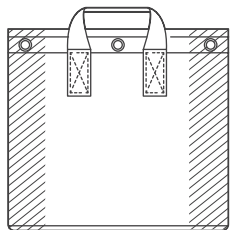

FABRIC POTS,  
5 gal.  
**BOX H**

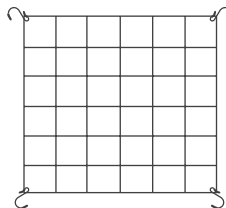

ELASTIC  
TRELLIS NETTING  
**BOX I**

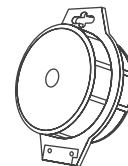

GARDEN PLANT  
TWIST TIES  
**BOX I**



STAINLESS STEEL  
PRUNING SNIPS  
**BOX I**

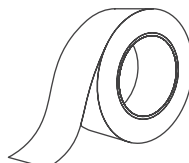

ALUMINUM  
DUCTING TAPE  
**BOX I**

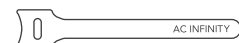

HOOK AND LOOP  
CABLE TIES  
**BOX I**



# PRODUCT CONTENTS

## DETAILS

	Advance Grow Tent Kit (2x2) COMPACT AC-PKA22	Advance Grow Tent Kit (2x2) AC-PKB22	Advance Grow Tent Kit (2x4) AC-PKB24	Advance Grow Tent Kit (3x3) AC-PKB33	Advance Grow Tent Kit (4x4) AC-PKB44	Advance Grow Tent Kit (5x5) AC-PKB55
<b>BOX A GROW TENT</b>	CLOUDLAB 422, 24" x 24" x 48" x1	CLOUDLAB 722, 24" x 24" x 72" x1	CLOUDLAB 642, 24" x 48" x 72" x1	CLOUDLAB 733, 36" x 36" x 72" x1	CLOUDLAB 844, 48" x 48" x 80" x1	CLOUDLAB 866, 60" x 60" x 80" x1
<b>BOX B GROW TENT CONTROLLER</b>	CONTROLLER 69 PRO, 4 Ports x1	CONTROLLER 69 PRO, 4 Ports x1	CONTROLLER 69 PRO, 4 Ports x1	CONTROLLER 69 PRO, 4 Ports x1	CONTROLLER 69 PRO, 4 Ports x1	CONTROLLER 69 PRO, 4 Ports x1
<b>BOX C INLINE FAN</b>	CLOUDLINE A4, Inline Fan 4 in. x1	CLOUDLINE A4, Inline Fan 4 in. x1	CLOUDLINE A6, Inline Fan 6 in. x1	CLOUDLINE A6, Inline Fan 6 in. x1	CLOUDLINE A6, Inline Fan 6 in. x1	CLOUDLINE PRO T6, Inline Fan 6 in. x1
<b>BOXES C &amp; F HANGING STRAPS</b>	Nylon Hanging Straps x2 per box	Nylon Hanging Straps x2 per box	Nylon Hanging Straps x2 per box	Nylon Hanging Straps x2 per box	Nylon Hanging Straps x2 per box	Nylon Hanging Straps x2 per box
<b>BOX D LED GROW LIGHT</b>	IONBOARD S22, 2x2 Coverage x1	IONBOARD S22, 2x2 Coverage x1	IONBOARD S24, 2x4 Coverage x1	IONBOARD S33, 3x3 Coverage x1	IONBOARD S44, 4x4 Coverage x1	IONFRAME EVO8, 5x5 Coverage x1
<b>BOXES D ROPE CLIP HANGERS</b>	Adjustable Hangers x2	Adjustable Hangers x2	Adjustable Hangers x2	Adjustable Hangers x2	Adjustable Hangers x2	Adjustable Hangers x2
<b>BOXES D CONTROLLER CORD</b>	UIS Male-Male Controller Cord x1	UIS Male-Male Controller Cord x1	UIS Male-Male Controller Cord x1	UIS Male-Male Controller Cord x1	UIS Male-Male Controller Cord x1	UIS Male-Male Controller Cord x1
<b>BOX E CLIP-ON FAN</b>	CLOUDRAY S6, Oscillating Clip Fan x1	CLOUDRAY S6, Oscillating Clip Fan x1	CLOUDRAY S6, Oscillating Clip Fan x1	CLOUDRAY S6, Oscillating Clip Fan x1	CLOUDRAY S6, Oscillating Clip Fans x2	CLOUDRAY S6, Oscillating Clip Fans x2
<b>BOXES E L-SHAPED CONTROLLER CORD</b>	UIS Male-Male Controller Cord x1	UIS Male-Male Controller Cord x1	UIS Male-Male Controller Cord x1	UIS Male-Male Controller Cord x1	UIS Male-Male Controller Cord x2	UIS Male-Male Controller Cord x2
<b>BOX F CARBON FILTER</b>	Inline Carbon Filter, 4 in. x1	Inline Carbon Filter, 4 in. x1	Inline Carbon Filter, 6 in. x1	Inline Carbon Filter, 6 in. x1	Inline Carbon Filter, 6 in. x1	Inline Carbon Filter, 6 in. x1
<b>BOX G DUCTING</b>	4 in. Flexible Ducting, 8 ft. Length x1	4 in. Flexible Ducting, 8 ft. Length x1	6 in. Flexible Ducting, 8 ft. Length x1	6 in. Flexible Ducting, 8 ft. Length x1	6 in. Flexible Ducting, 8 ft. Length x1	6 in. Flexible Ducting, 8 ft. Length x1
<b>BOX G CLAMPS</b>	4 in. Silver Metal Clamp x2	4 in. Silver Metal Clamp x2	6 in. Silver Metal Clamp x2	6 in. Silver Metal Clamp x2	6 in. Silver Metal Clamp x2	6 in. Silver Metal Clamp x2
<b>BOX H FABRIC POTS</b>	Fabric Pots, 5 gal. x2	Fabric Pots, 5 gal. x2	Fabric Pots, 5 gal. x4	Fabric Pots, 5 gal. x6	Fabric Pots, 5 gal. x8	Fabric Pots, 5 gal. x12
<b>BOX I TRELLIS NETTING</b>	Elastic Trellis Netting 2' x 2' x1	Elastic Trellis Netting 2' x 2' x1	Elastic Trellis Netting 2' x 4' x1	Elastic Trellis Netting 3' x 3' x1	Elastic Trellis Netting 4' x 4' x1	Elastic Trellis Netting 5' x 5' x1
<b>BOX I TWIST TIES</b>	Wire Plant Tie, Black x1	Wire Plant Tie, Black x1	Wire Plant Tie, Black x1	Wire Plant Tie, Black x1	Wire Plant Tie, Black x1	Wire Plant Tie, Black x1
<b>BOX I PRUNING SNIPS</b>	Micro-Tip Shears x1	Micro-Tip Shears x1	Micro-Tip Shears x1	Micro-Tip Shears x1	Micro-Tip Shears x1	Micro-Tip Shears x1
<b>BOX I DUCTING TAPE</b>	Aluminum Tape, 5 ft. x1	Aluminum Tape, 5 ft. x1	Aluminum Tape, 5 ft. x1	Aluminum Tape, 5 ft. x1	Aluminum Tape, 5 ft. x1	Aluminum Tape, 5 ft. x1
<b>BOX I HOOK AND LOOP TIES</b>	Hook and Loop Cable Tie x10	Hook and Loop Cable Tie x10	Hook and Loop Cable Tie x10	Hook and Loop Cable Tie x10	Hook and Loop Cable Tie x10	Hook and Loop Cable Tie x10

# QUICK BUILD GUIDE

- 1** Build the **Grow Tent (BOX A)**.  
Refer to pages 12-25.

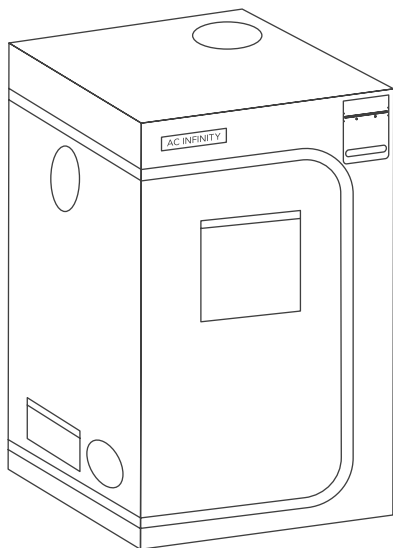

- 2** Install the **Inline Fan with Straps (BOX C)**, **Ducting and Clamps (BOX G)** to your preferred configuration.  
Refer to pages 26-39.

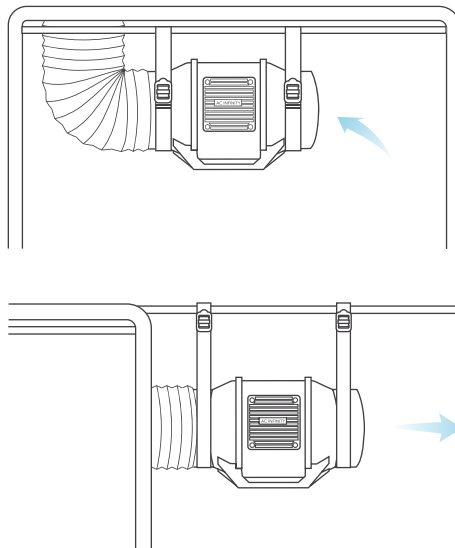

- 3** You may connect and hang the **Carbon Filter** with **Straps (BOX F)** to your ductwork.  
Refer to pages 40-51. Use **Duct Tape (BOX I)** to seal any gaps in the ducting.

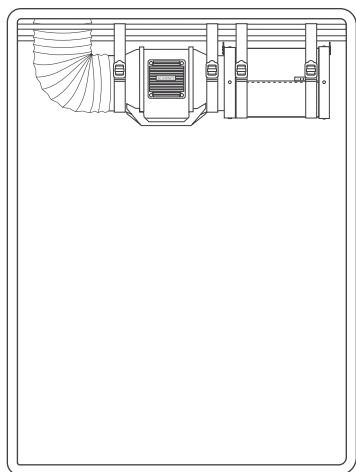

- 4** Hang the **Grow Light** using **Rope Hangers (BOX D)** by the roof support beams.  
Refer to pages 52-67. Turn the knob to "UIS" to pair and connect with the controller.

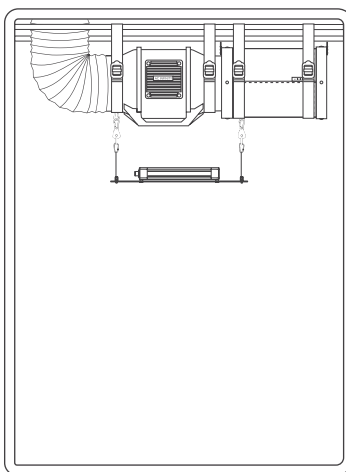

- 5** Clamp the **Clip Fan (BOX E)** onto the tent frame.  
Refer to pages 68-77.

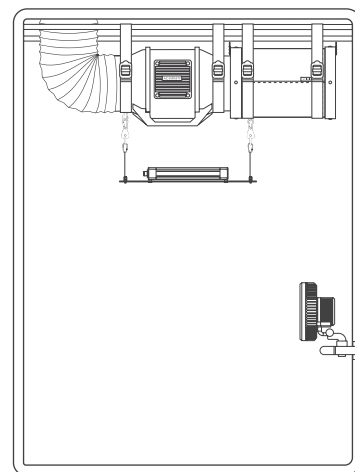

# QUICK BUILD GUIDE

- 6** Mount the **Grow Tent Controller (BOX B)** onto the **Controller Plate (BOX A)**. Refer to page 20.

Plug the probe into the probe port. Plug the **Inline Fan's controller cable (BOX C)** into Port 1, the **Grow Light's controller cable (BOX D)** into Port 2, and the **Clip Fan's controller cable (BOX E)** into Port 3. Plug the second **Clip Fan's controller cable (BOX E)** into Port 4 (AC-PKB44 and AC-PKB55 models only). Refer to page 80.

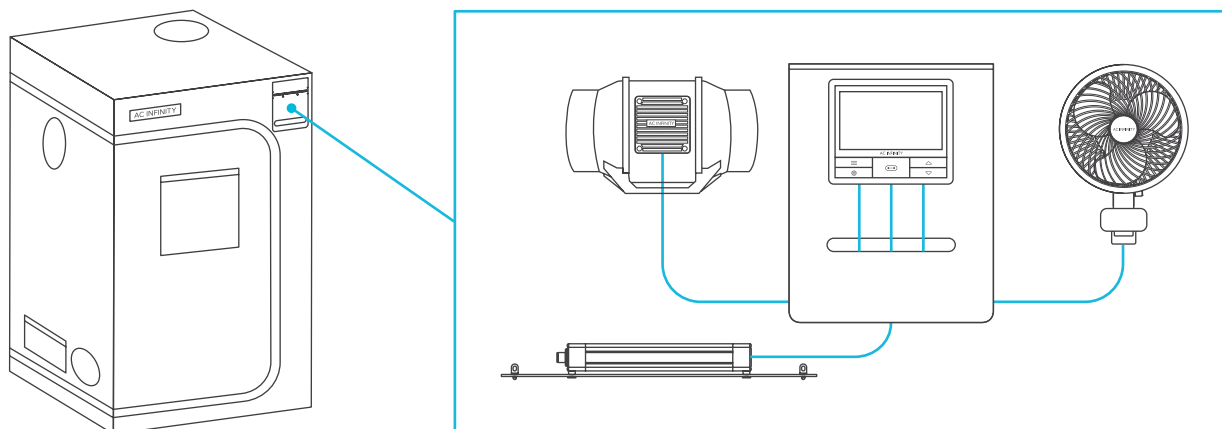

- 7** Use the **Hook and Loop Ties (BOX I)** to manage the wires.

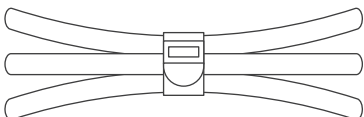

- 8** Plug all the electronic devices into available AC outlets.

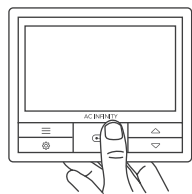
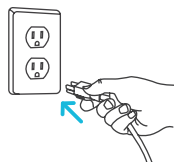

- 9** Set the **Grow Tent Controller's (BOX B)** clock time to your local time. Refer to page 102.

The **Grow Tent Controller** is pre-programmed with the following settings:

- Port 1 – **Inline Fan** set to Fan Speed Level 5 scheduled between 6:00pm and 12:00pm, and to Level 2 scheduled between 12:00pm and 6:00pm.
- Port 2 – **Grow Light** set to Brightness Intensity Level 10 scheduled between 6:00pm and 12:00pm and to Level 0 scheduled between 12:00pm and 6:00pm.
- Port 3 – **Clip Fan** set to Level 5.
- Port 4 – **Clip Fan** set to Level 5 (AC-PKB44 and AC-PKB55 models only).



Add potting mix and plant seeds into the **Fabric Pot (BOX H)**, and set it inside of the grow tent to finish the build.



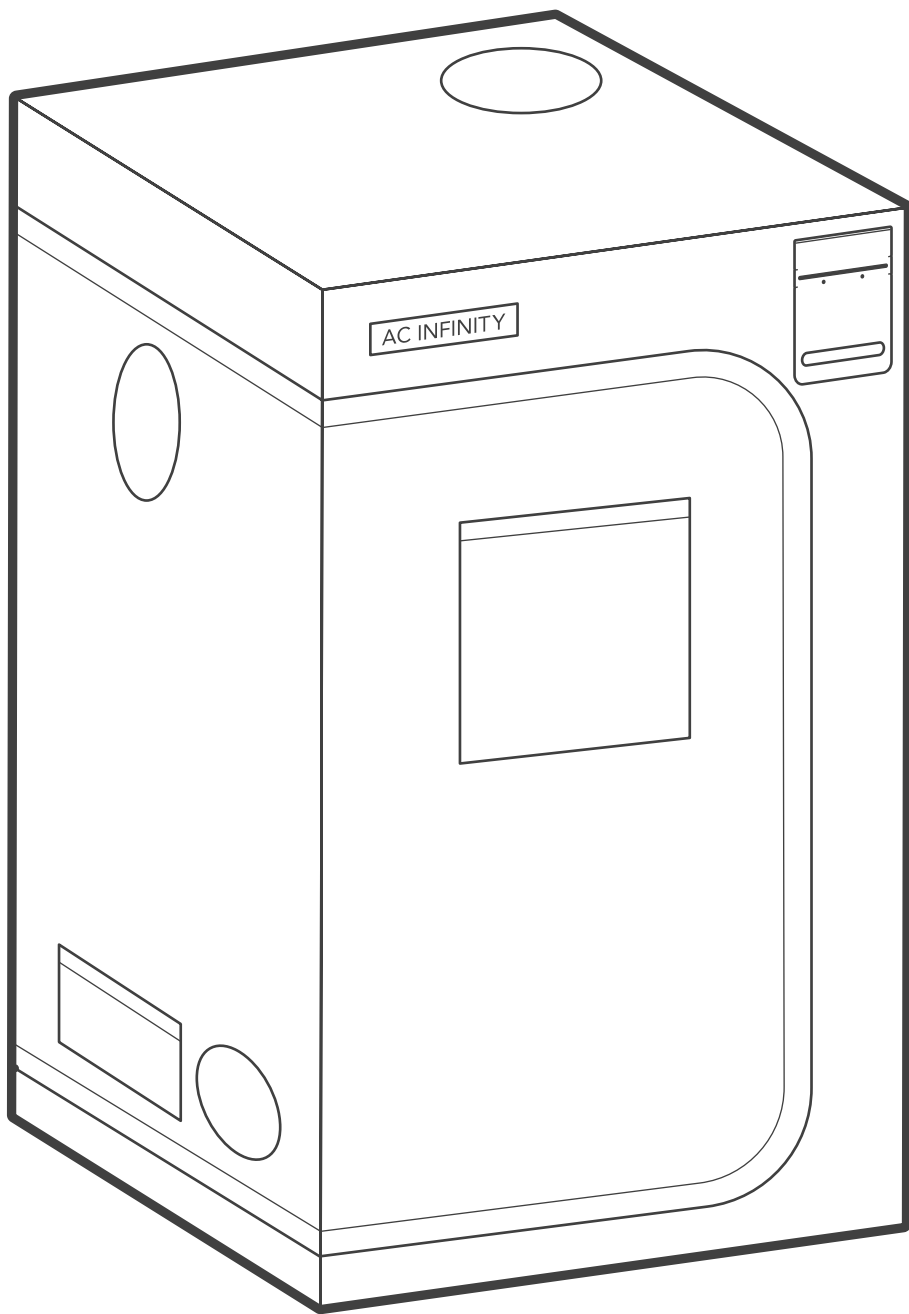

# CLOUDLAB SERIES

## ADVANCE GROW TENT

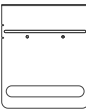

# ADVANCE GROW TENT

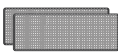
## PRODUCT CONTENTS

	Advance Grow Tent Kit (2x2) COMPACT AC-PA22	Advance Grow Tent Kit (2x2) AC-PKB22	Advance Grow Tent Kit (2x4) AC-PKB24	Advance Grow Tent Kit (3x3) AC-PKB33	Advance Grow Tent Kit (4x4) AC-PKB44	Advance Grow Tent Kit (5x5) AC-PKB55
 GROW TENT	CLOUDLAB 422, 24" x 24" x 48" x1	CLOUDLAB 722, 24" x 24" x 72" x1	CLOUDLAB 642, 24" x 48" x 72" x1	CLOUDLAB 733, 36" x 36" x 72" x1	CLOUDLAB 844, 48" x 48" x 80" x1	CLOUDLAB 866, 60" x 60" x 80" x1
 CONTROLLER MOUNTING PLATE	x1	x1	x1	x1	x1	x1
 WALL HANG SCREWS WITH NUTS	x4	x4	x4	x4	x4	x4
 CONTROLLER PLATE BOLTS WITH NUTS	x4	x4	x4	x4	x4	x4
 CONTROLLER HOOK AND LOOP PADS	x6	x6	x6	x6	x6	x6
 NYLON HANGING STRAPS	x2	x2	x2	x2	x2	x2

# CLOUDLAB

## PRODUCT CONTENTS

CLOUDLAB SERIES Included only with

CLOUDLAB 422 AC-CBA422  
 CLOUDLAB 722 AC-CBA722

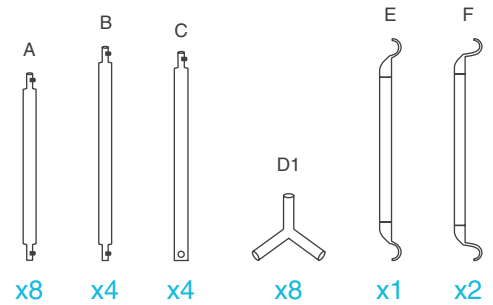

FRAME POLES

CLOUDLAB SERIES Included only with

CLOUDLAB 642 AC-CBA642

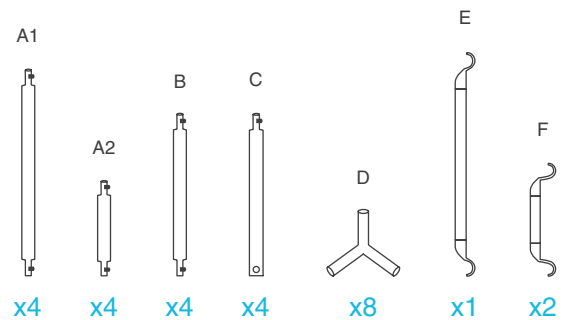

FRAME POLES

CLOUDLAB SERIES Included only with

CLOUDLAB 733 AC-CBA733  
 CLOUDLAB 844 AC-CBA844  
 CLOUDLAB 866 AC-CBA866

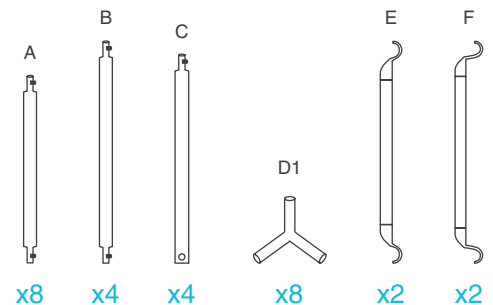

FRAME POLES

NOTE: Pole lengths may vary between all models.

# CLOUDLAB

## TENT SETUP

### STEP 1

Insert the eight (A) poles\* and into the floor end of the corner (D1) pieces to create two bases.

When assembling, make sure the feet of each corner (D1) piece faces the floor with the arrow facing down.

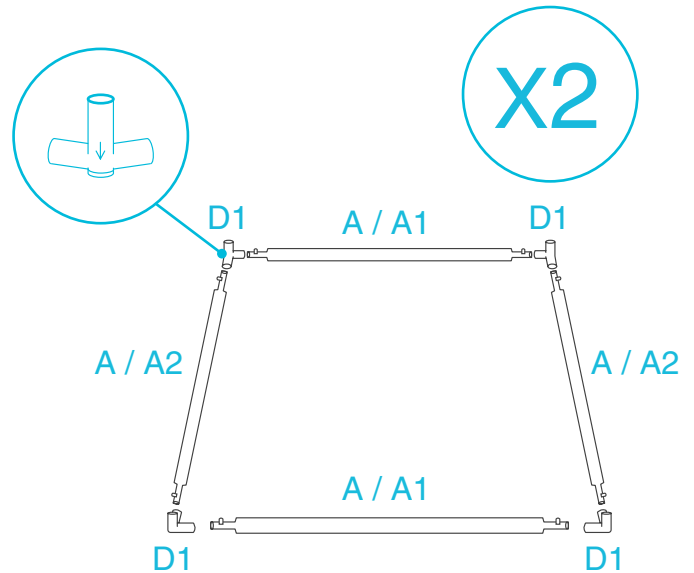

\*Poles in CLOUDLAB 642 are labeled A1 & A2.\*

### STEP 2

Insert the four (B) poles into Base One.  
Insert the four (C) poles into Base Two.

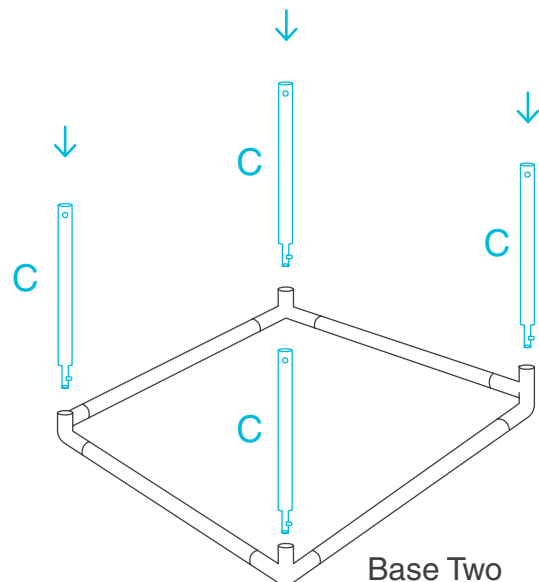
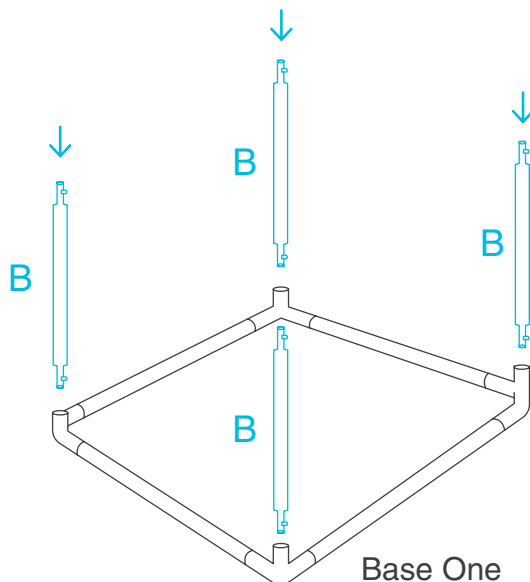

# CLOUDLAB

## TENT SETUP

### STEP 3

Unzip the tent so that three of the walls lay flat.

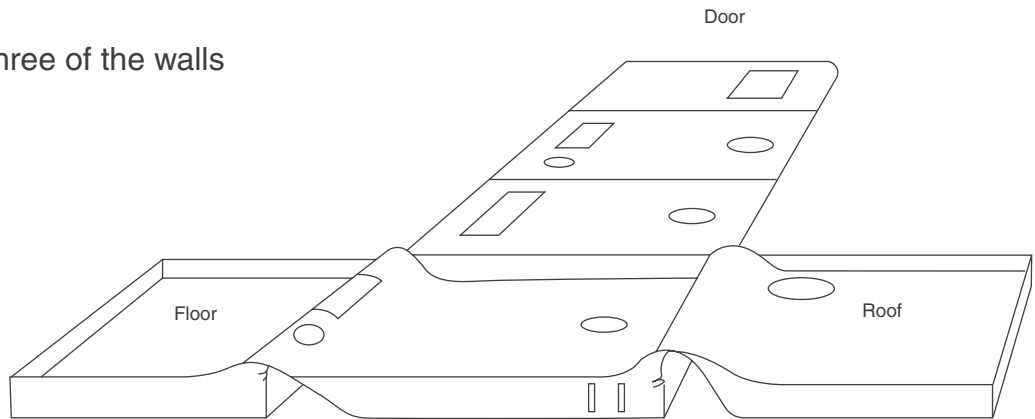

### STEP 4

Guide Base One into the floor of the tent, making sure its corners meet the tent's corners.

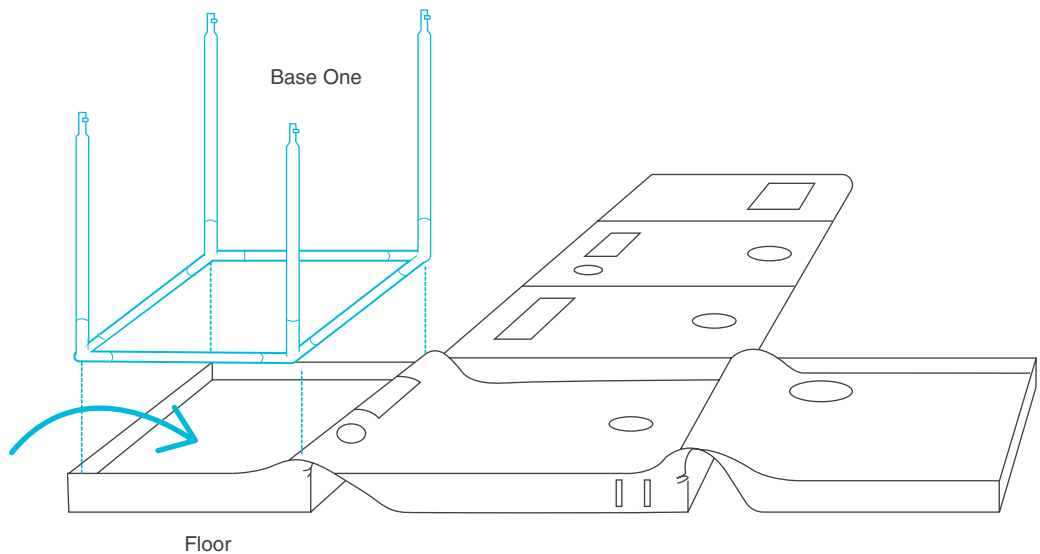



# CLOUDLAB

## TENT SETUP

### STEP 5

Insert the poles of Base Two into the poles of Base One to complete the frame.

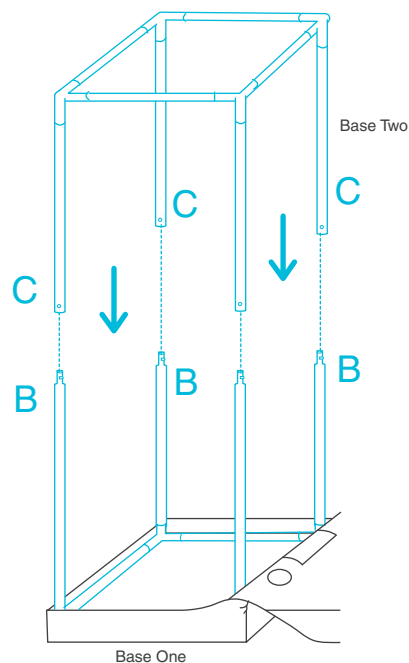

Two people are recommended for this portion of the tent assembly.

---

### STEP 6

Pull the roof over the assembled frame.

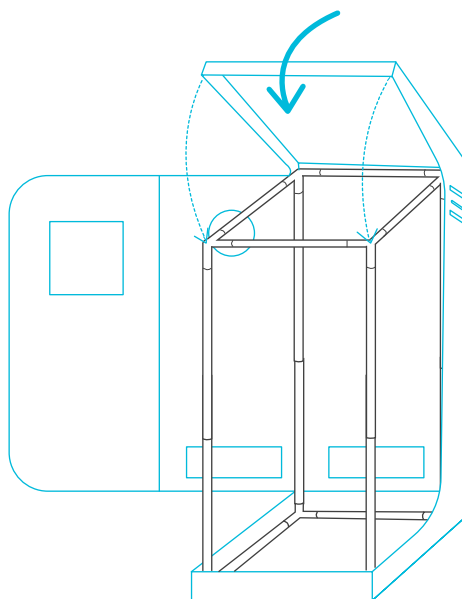

Two people are recommended for this portion of the tent assembly.

# CLOUDLAB

## TENT SETUP

### STEP 7

Pull the upper and lower zippers to close the walls and door.

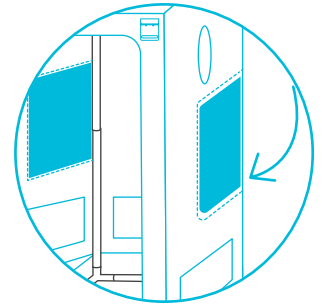
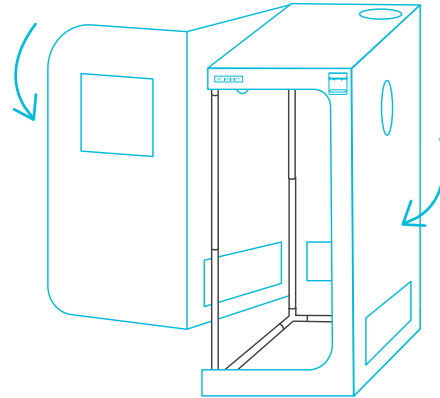

\*CLOUDLAB 733 / 844 / 866 are built with additional side doors.

### STEP 8

You can neatly hold the window wall open any time by using its attached hook and loop strap.

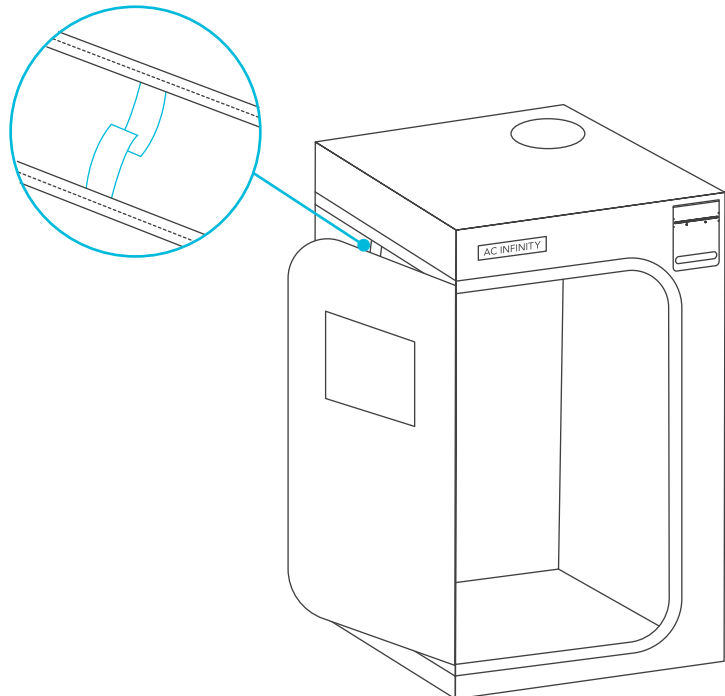

# CLOUDLAB

## TENT SETUP

### STEP 9

Add the roof support beams (E) then (F). Insert the spill pool into the tent and secure the hook and loop straps around the poles.

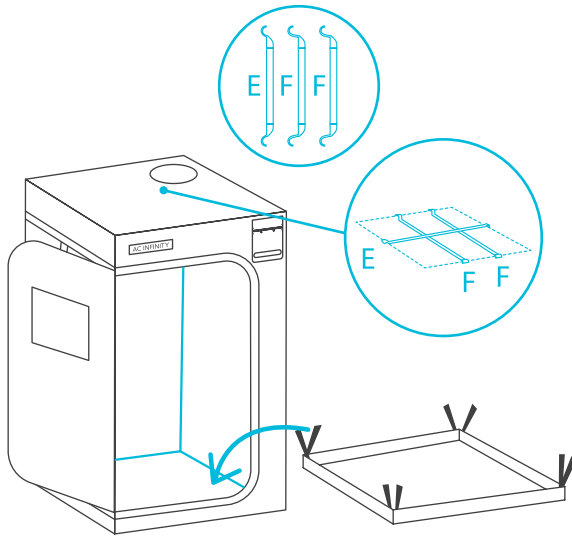

**CLOUDLAB 422 / 722**

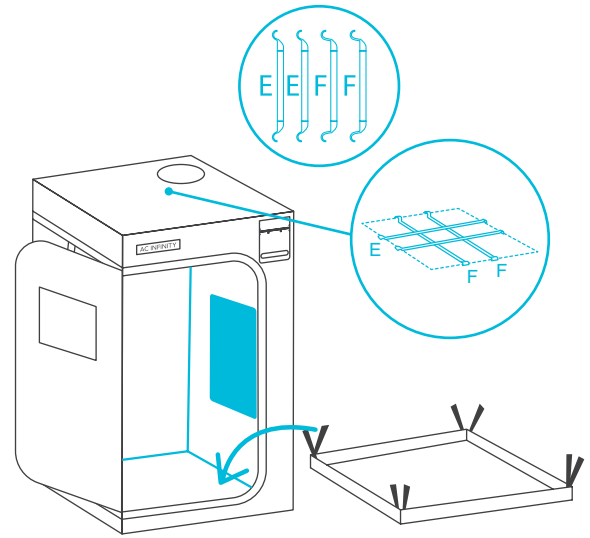

**CLOUDLAB 733**

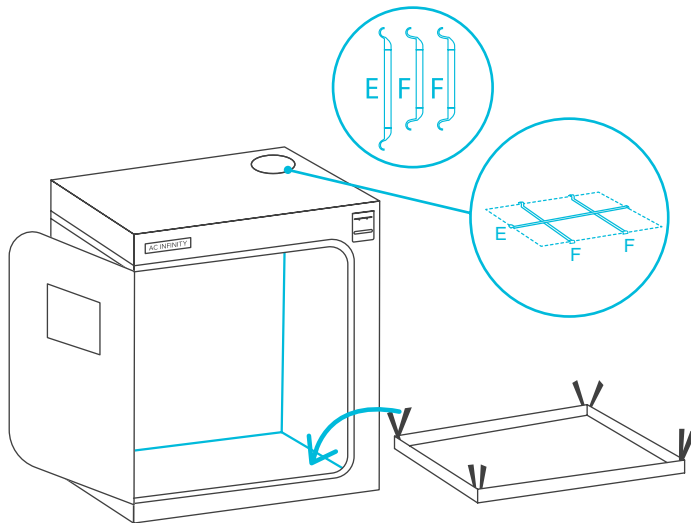

**CLOUDLAB 642**

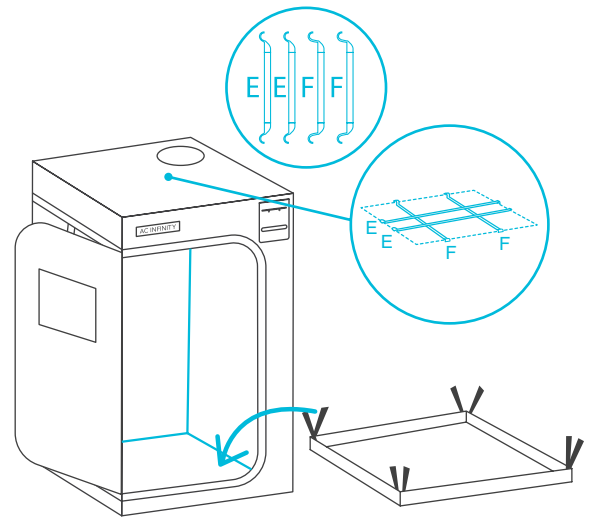

**CLOUDLAB 844 / 866**

\*CLOUDLAB 733 / 844 / 866 are built with additional side doors.

# CLOUDLAB

## CONTROLLER PLATE SETUP

### STEP 1

Magnetically mount the controller onto the bracket.

Refer to pages 82-83 for additional controller mounting methods.

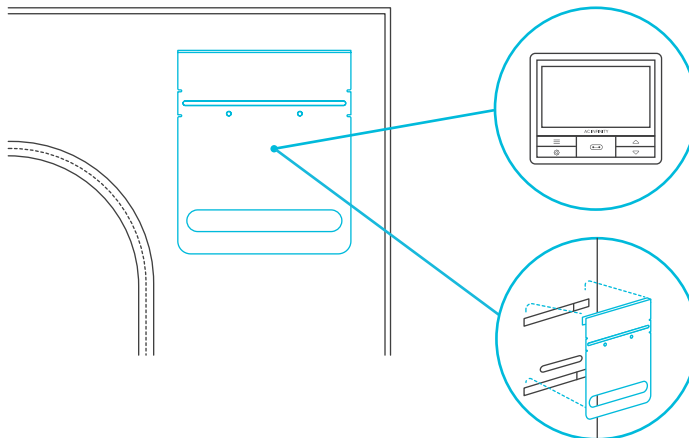

### STEP 2

Slide the controller bracket assembly into the tent straps.

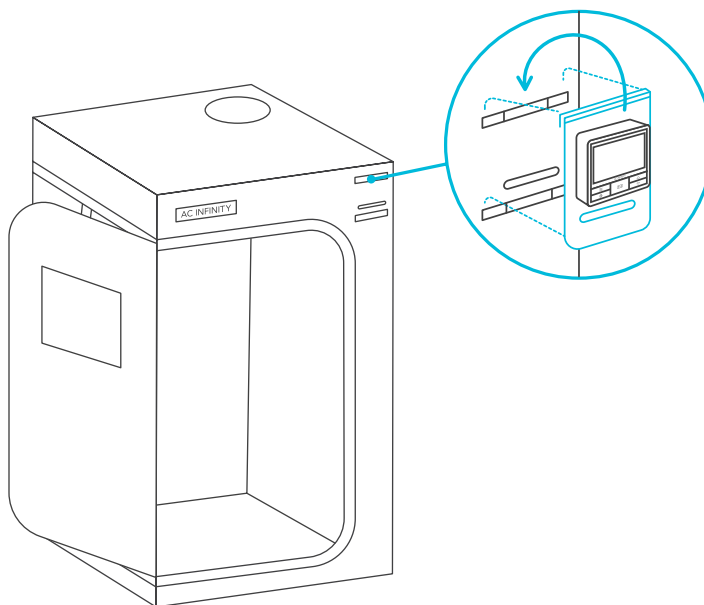

CLOUDLAB 866 will include a lower third strap for an alternate mounting location.

# CLOUDLAB

## CONTROLLER PLATE SETUP

### STEP 3

Route your inline duct fan's power connector through the opening inside and plug it into your controller.

Plug the probe into the controller and route its cables through the opening.

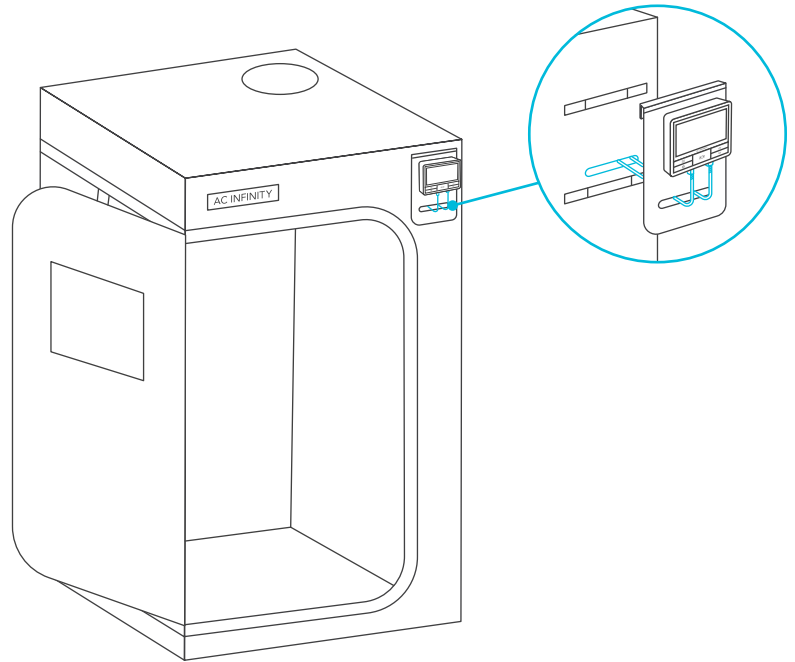

# CLOUDLAB

## MOUNTING GUIDE

### CONTROLLER PLATE

This grow tent includes a steel plate with a mounting slot for AC Infinity controllers. Mount your controller to the corresponding areas on the plate's slot. Route its wires through the oval opening and through the grow tent's flap. Some controller models may contain a hidden magnet on the backside, which can stick onto this plate without screws.

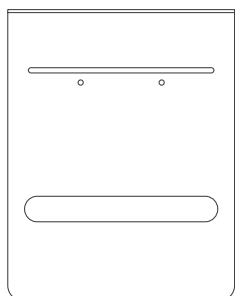
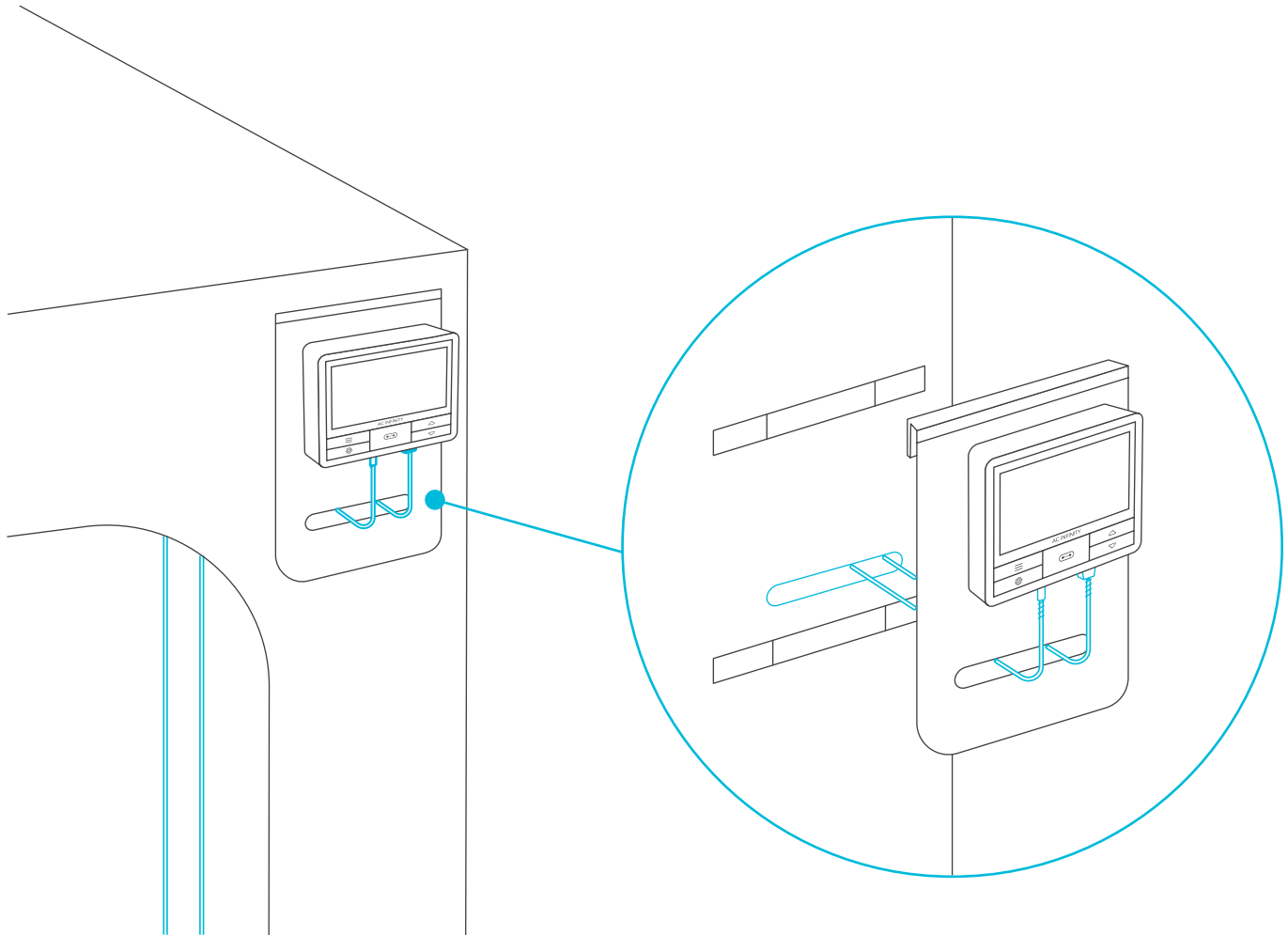

**ONLY INCLUDED WITH**  
CLOUDLAB 642  
CLOUDLAB 844  
CLOUDLAB 866

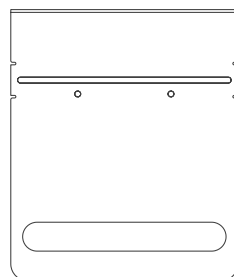

**ONLY INCLUDED WITH**  
CLOUDLAB 422  
CLOUDLAB 722  
CLOUDLAB 733

# CLOUDLAB

## VENTILATION GUIDE

### INLINE FAN AND GROW LIGHT

First hang your inline duct fan to be used as an exhaust fan by the roof support beams. Position the intake fan at the bottom end so the intake air will be passive through the bottom vents. If you are installing a carbon filter inside, use the included straps to hang the carbon filter.

Then install your grow light. You may use rope clip hangers to install these products.

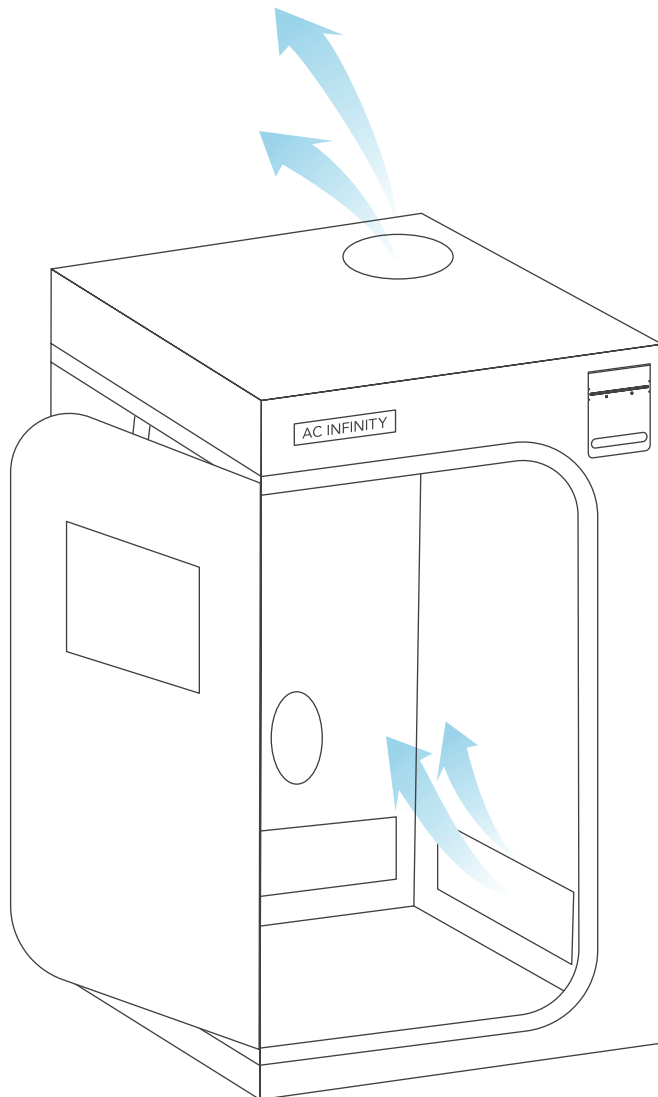

### DOUBLE-SIDED CINCHES

Install any necessary duct tubes onto the ducting ports. Use the cinches on either end to secure the duct tubes onto the grow tent.

### INTAKE HOLES

Introduce fresh air by using one of the two ventilation holes at the bottom of the grow tent. Open a passive intake screen or create active intake by attaching an additional inline fan to a duct port.

### NEED MORE INFORMATION?

Scan the QR code or visit [www.acinfinity.com](http://www.acinfinity.com) for more guides and tutorials.



# CLOUDLAB

## CONFIGURATION SETUP

### LIGHT AND VENTILATION PLACEMENT

There are many ways to configure these components to bring airflow into your grow space. A typical setup places the fan and the filter inside, which makes it easier to manage while dampening the fan noise. Both can be situated in any order within the ventilation chain if air is being pulled out of your grow space.

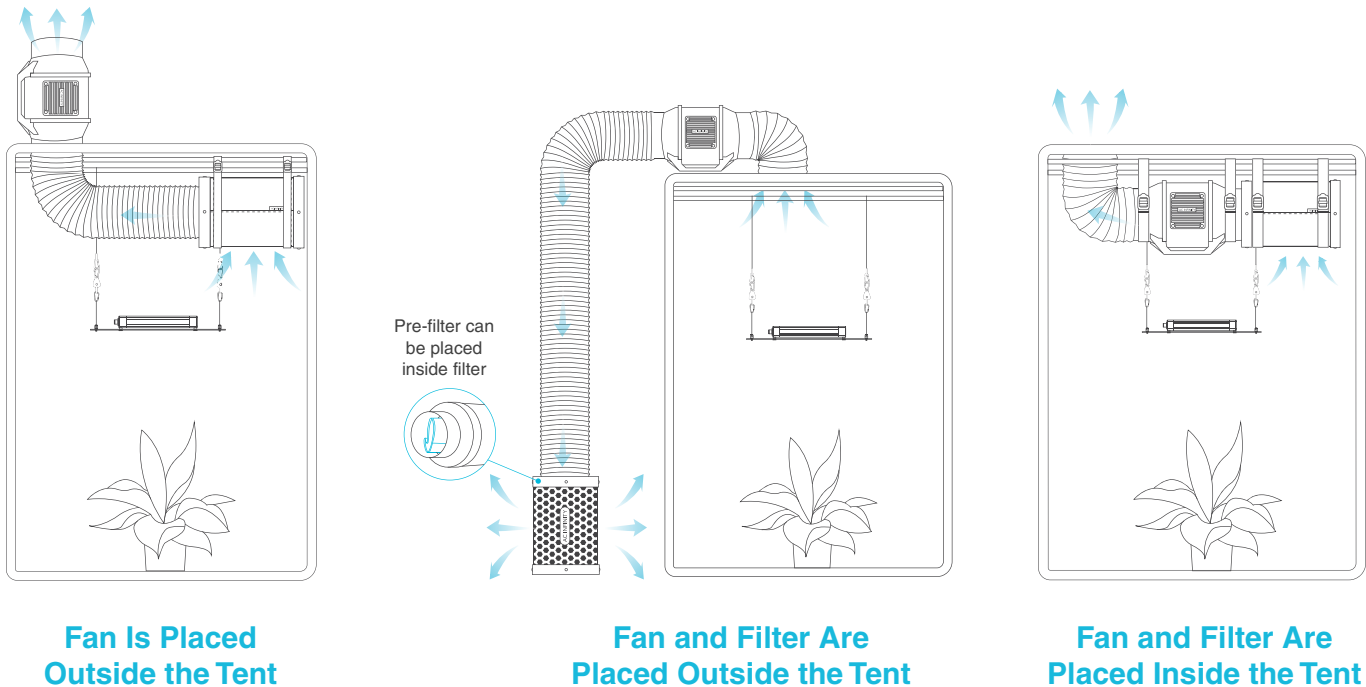

For example, your grow lights might get in the way of your cooling equipment. In this case, you may set the fan and/or filter outside of your grow tent.

We recommend setting your extraction fan at the highest point possible. Since heat rises to the top, exhausting that hot air at that point will make the ventilation process efficient. Your carbon filter will also perform better if it's positioned at the highest point.





# CLOUDLINE



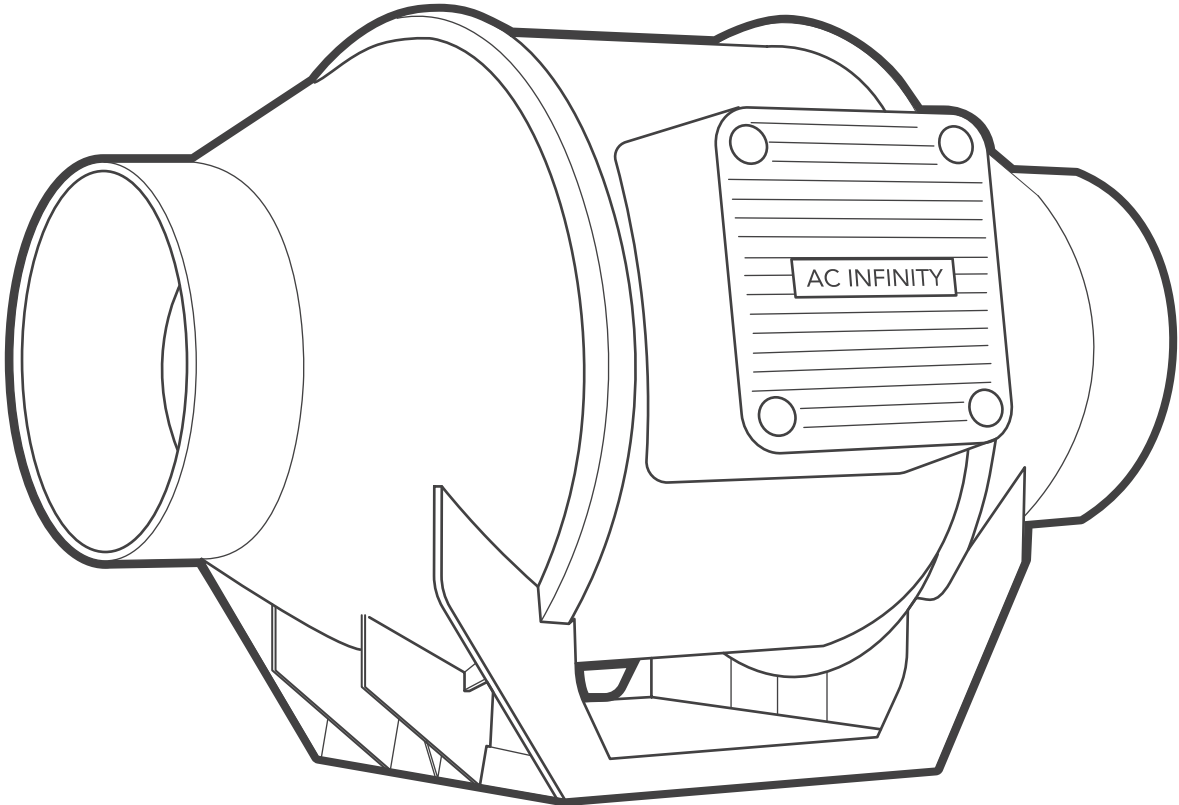

## MIXED FLOW INLINE FAN SYSTEMS

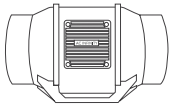

CLOUDLINE A4 shown

# CLOUDLINE

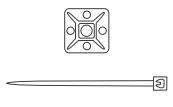
## PRODUCT CONTENTS

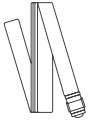
	Advance Grow Tent Kit (2x2) COMPACT AC-PKA22	Advance Grow Tent Kit (2x2) AC-PKB22	Advance Grow Tent Kit (2x4) AC-PKB24	Advance Grow Tent Kit (3x3) AC-PKB33	Advance Grow Tent Kit (4x4) AC-PKB44	Advance Grow Tent Kit (5x5) AC-PKB55
 <b>INLINE FAN</b>	CLOUDLINE A4 Inline Fan 4 in. x1	CLOUDLINE A4 Inline Fan 4 in. x1	CLOUDLINE A6 Inline Fan 6 in. x1	CLOUDLINE A6 Inline Fan 6 in. x1	CLOUDLINE A6 Inline Fan 6 in. x1	CLOUDLINE PRO T6 Inline Fan 6 in. x1
 <b>WIRE TIE WITH MOUNTING BASE AND SCREW</b>	x6	x6	x6	x6	x6	x6
 <b>WIRE TIE WITH 3M BASE</b>	x1	x1	x1	x1	x1	x1
 <b>DUCT FAN MOUNTING SCREW WITH PLASTIC ANCHOR</b>	x4	x4	x4	x4	x4	x4
 <b>NYLON HANGING STRAPS</b>	x2	x2	x2	x2	x2	x2

# CLOUDLINE

## MOUNTING

### STEP 1

Unscrew the bolts on both sides from the plastic rings using a Phillips screwdriver.

Pliers are also required for removing the metal rings of the CLOUDLINE PRO T6.

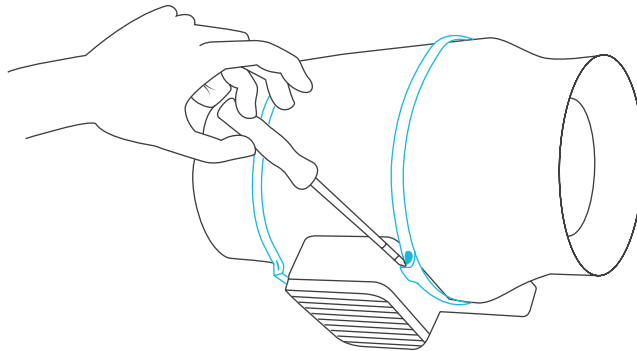

### STEP 2

Remove the motor box from the flange bracket. Remove the wind circle between the motor box and the intake flange.

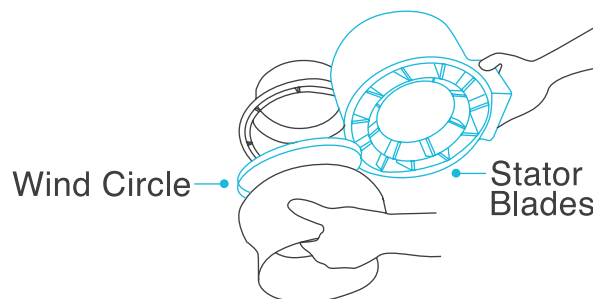
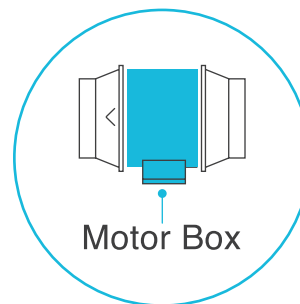

# CLOUDLINE

## MOUNTING

### STEP 3

Use the flange bracket to set your desired fan position. Mark the four mounting holes.

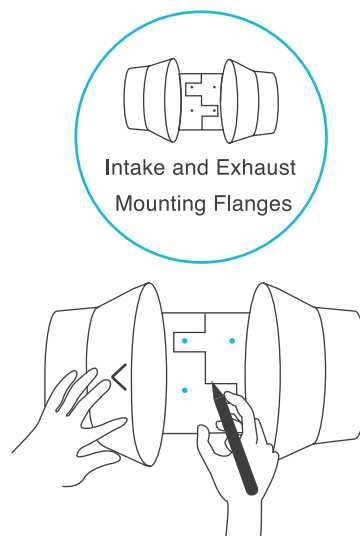

### STEP 4

Drill four holes into the marked locations. Make sure your mounting area is structurally sound and free from obstruction.

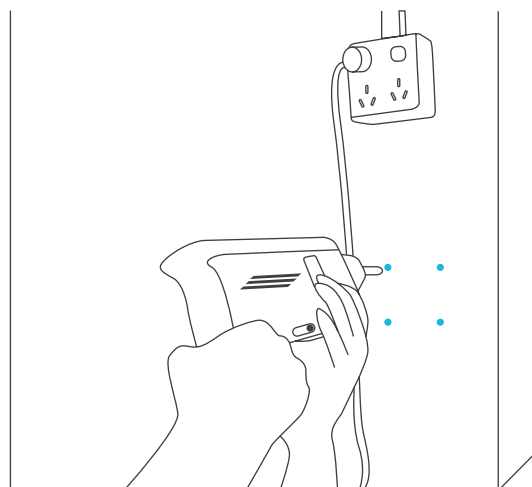

# CLOUDLINE

## MOUNTING

### STEP 5

If you are mounting onto anything other than a wood support or stud, insert the included four wall anchors into the drilled mounting holes.

You may need to use a hammer to secure them through the holes.

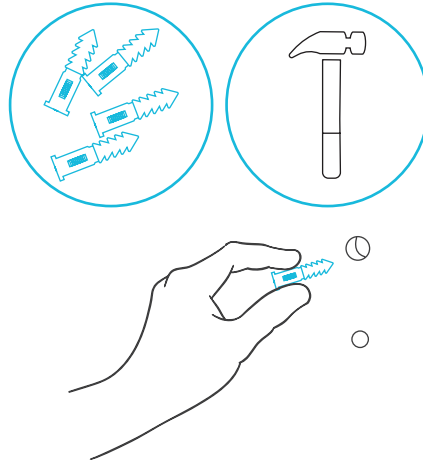

---

### STEP 6

Align the flange bracket's holes with the wall anchors. Screw in four wood screws with a screwdriver or drill to secure the flange bracket.

Make sure its airflow arrow is pointing in your desired direction.

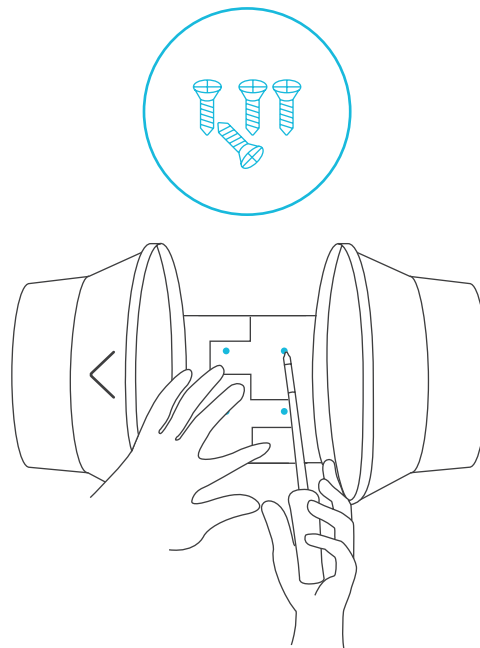

# CLOUDLINE

## MOUNTING

### STEP 7

Place the wind circle back into the intake flange.

Reposition the metal clamps over the flanges for the CLOUDLINE PRO T6.

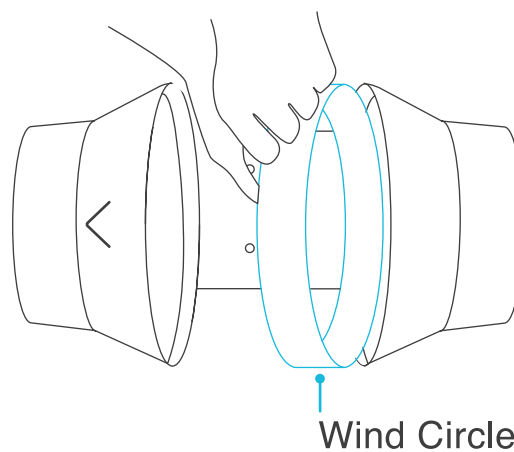

### STEP 8

Slide the motor box back into the flange bracket, making sure its airflow arrow is pointing in the same direction as the flange bracket's arrow.

For the CLOUDLINE A-series fans, crew the bolts back into the plastic rings to secure the motor box to the flange bracket.

For the CLOUDLINE PRO T6, tighten the metal clamps using a Phillips screwdriver and pliers to secure the motor box.

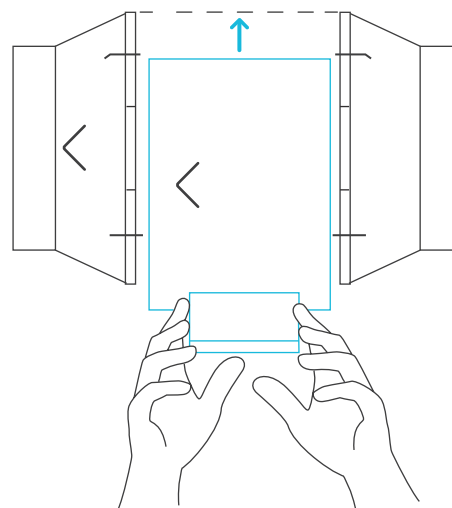

# CLOUDLINE

## MOUNTING

### STEP 9

If installing ducting, use the included duct clamps to secure it to either end of the duct fan, making sure there is a tight seal.

Tighten the duct clamps using a flathead screwdriver.

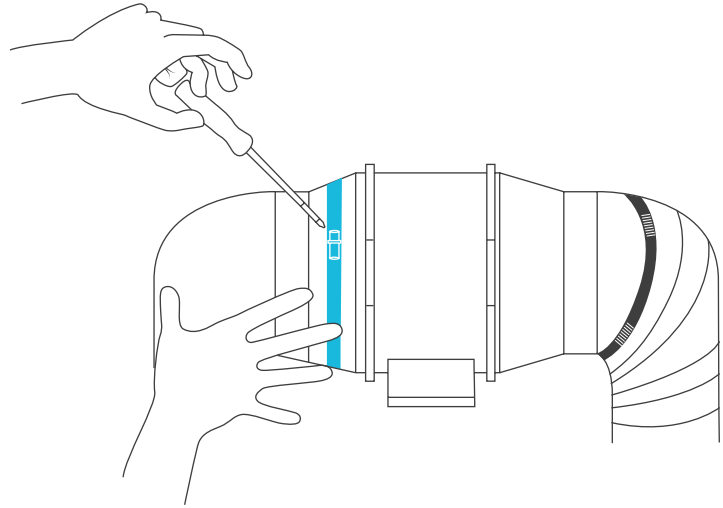

### POWERING AND SETUP

Plug the fan's power cord into an AC power outlet to power it and the controller.

Refer to pages 80-83 for controller installation instructions.

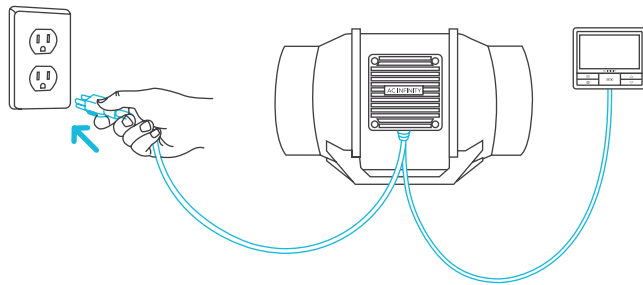



# CLOUDLINE

## OVERHEAD HANGING

### STEP 1

Loop the strap around the bracket and a pole.

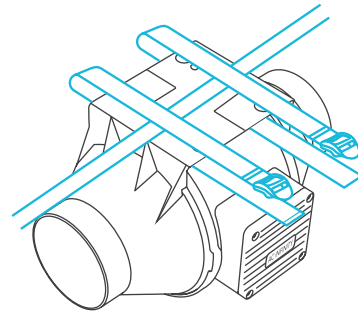

---

### STEP 2

Slip the strap through the inner ladder lock slot from the bottom.

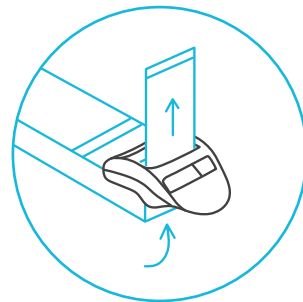

# CLOUDLINE

## OVERHEAD HANGING

### STEP 3

Route the strap into the outer ladder lock slot from the top. Adjust the length of the completed loop as needed.

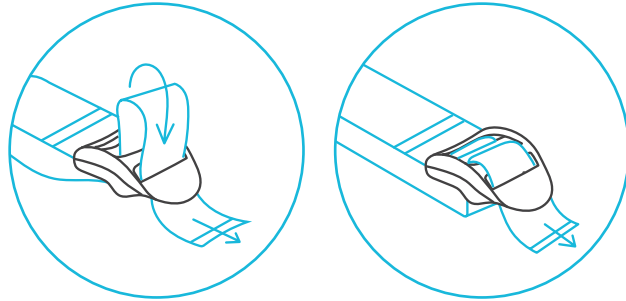

Adjust to size

---

### STEP 4

Tuck the loose end through the center gap of the ladder lock to secure the loop.

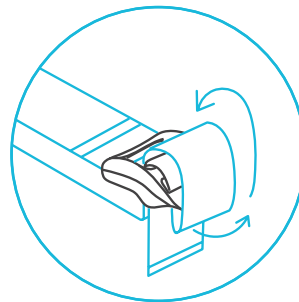

Loop through middle  
to lock in place

# CLOUDLINE

## OVERHEAD HANGING

### STEP 5(a) - Hanging Downward

Let the fan hang by the pole once the straps are secure.

Make sure the fan's airflow arrow is pointing towards your desired direction.

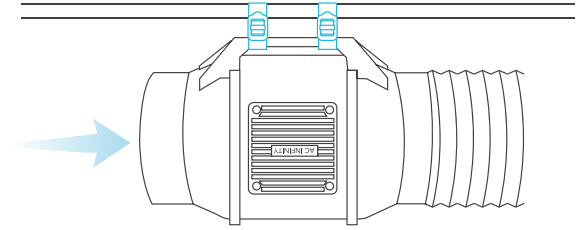

---

### STEP 5(b) - Hanging Upward

To hang the fan right-side up, loop and tighten the straps, as shown in steps 1-4, around the pole.

Hang the fan by the duct flanges to secure it.

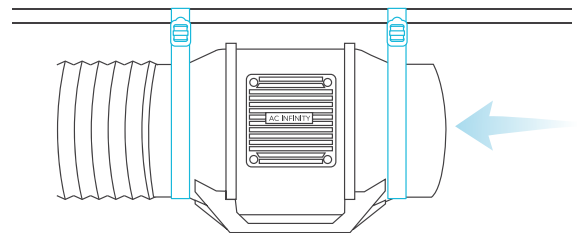

# CLOUDLINE

## MOTOR CAP

### STEP 1

Unscrew the motor cap using a screwdriver.

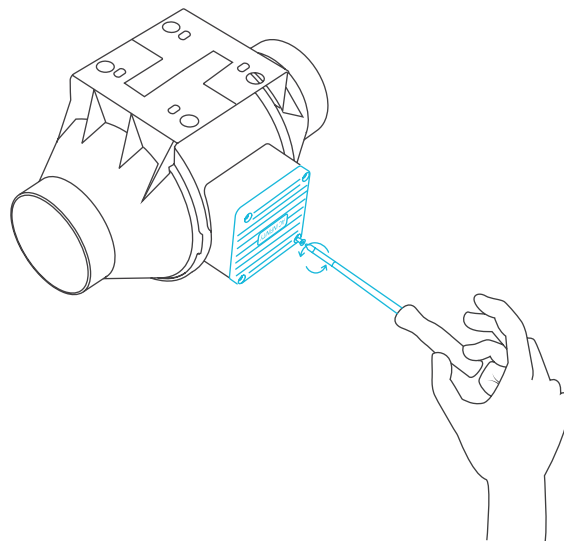

### STEP 2

Rotate the motor cap to your desired orientation. Reapply the screws.

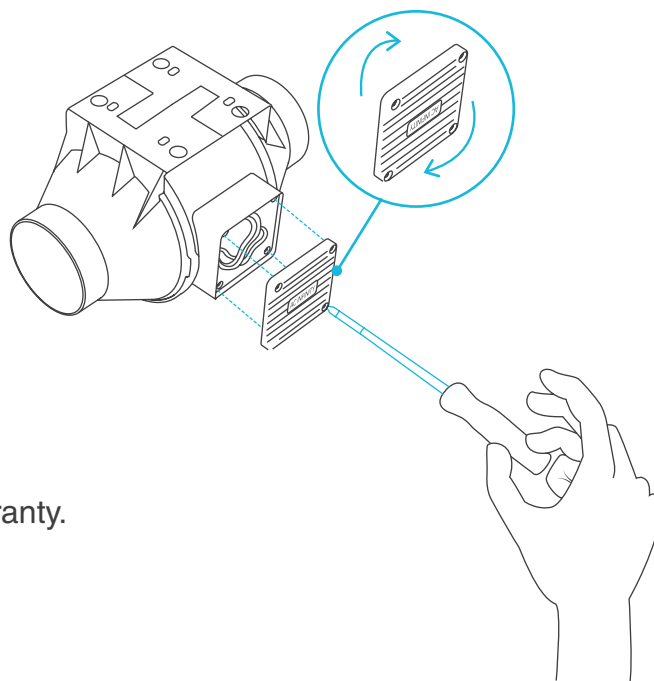

Rotating the motor cap will not void your warranty.

# CLOUDLINE

## CONFIGURATION SETUP

### INTAKE AND EXHAUST

This fan can be used as either an intake fan or an exhaust fan in grow rooms and larger grow tents. To achieve optimal whole space ventilation, the intake fan or opening—if not using a fan—must be situated at a bottom corner of your grow space. The exhaust fan must be hung (shown below) or mounted at the highest opposite corner possible.

Make sure the intake fan's airflow arrow is pointing towards your grow space and the exhaust fan's arrow points away from your grow space.

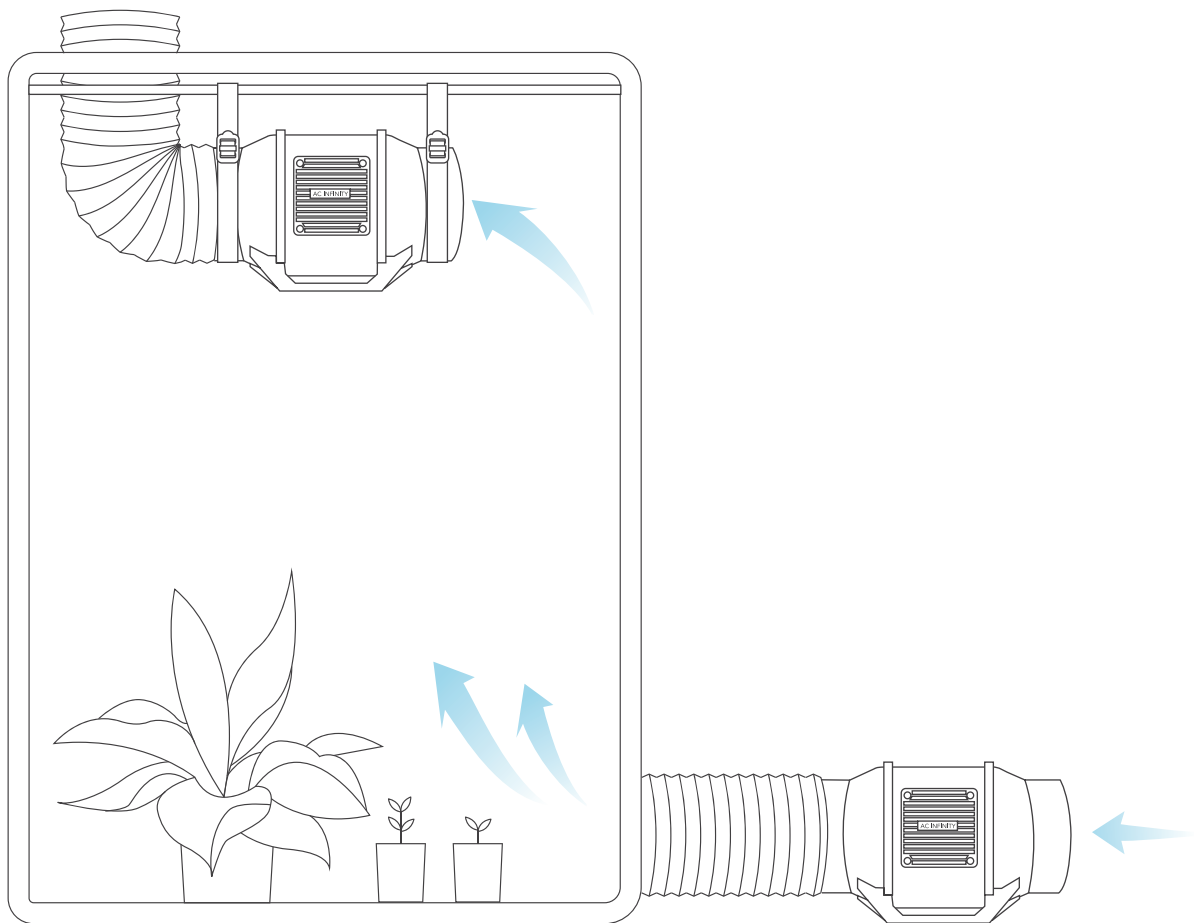

# CLOUDLINE

## CLEANING

### STEP 1

Remove the motor box from the mounting flange. Refer to steps 1-2 on page 28 to learn how to remove the motor box.

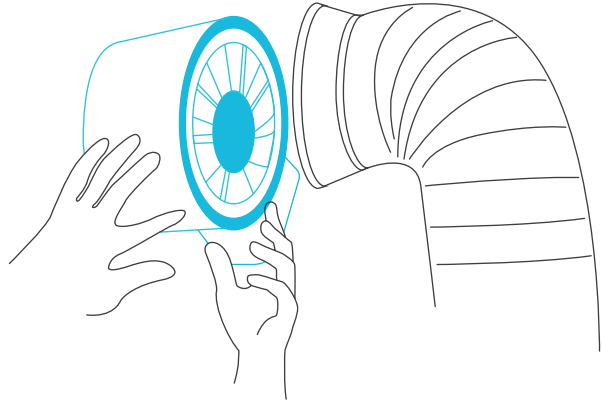

---

### STEP 2

Use a damp cloth to clear the impeller and fan blades of any dust and debris. Remove the wind circle in between the motor box and input flange.



# CLOUDLINE

## CLEANING

### STEP 3

Clear the stator blades of any dust and debris on the opposite end. Clean the area inside the output and exhaust flanges.

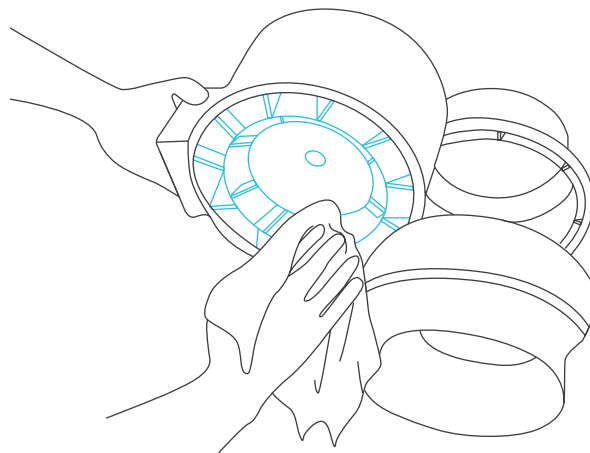

---

### STEP 4

Secure the motor box onto the mounting flanges. Refer to steps 7-9 on pages 31-32 to learn how to secure the motor box.

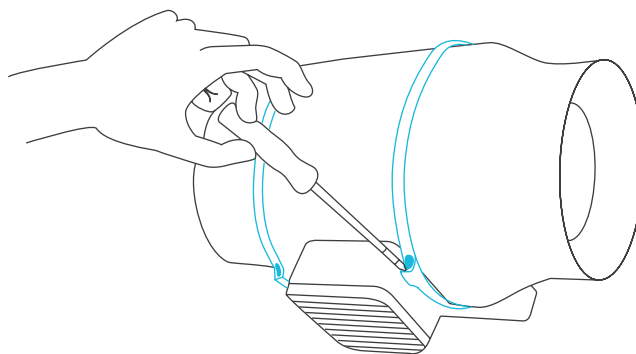

# DUCT CARBON FILTER

## PREMIUM AUSTRALIAN CHARCOAL

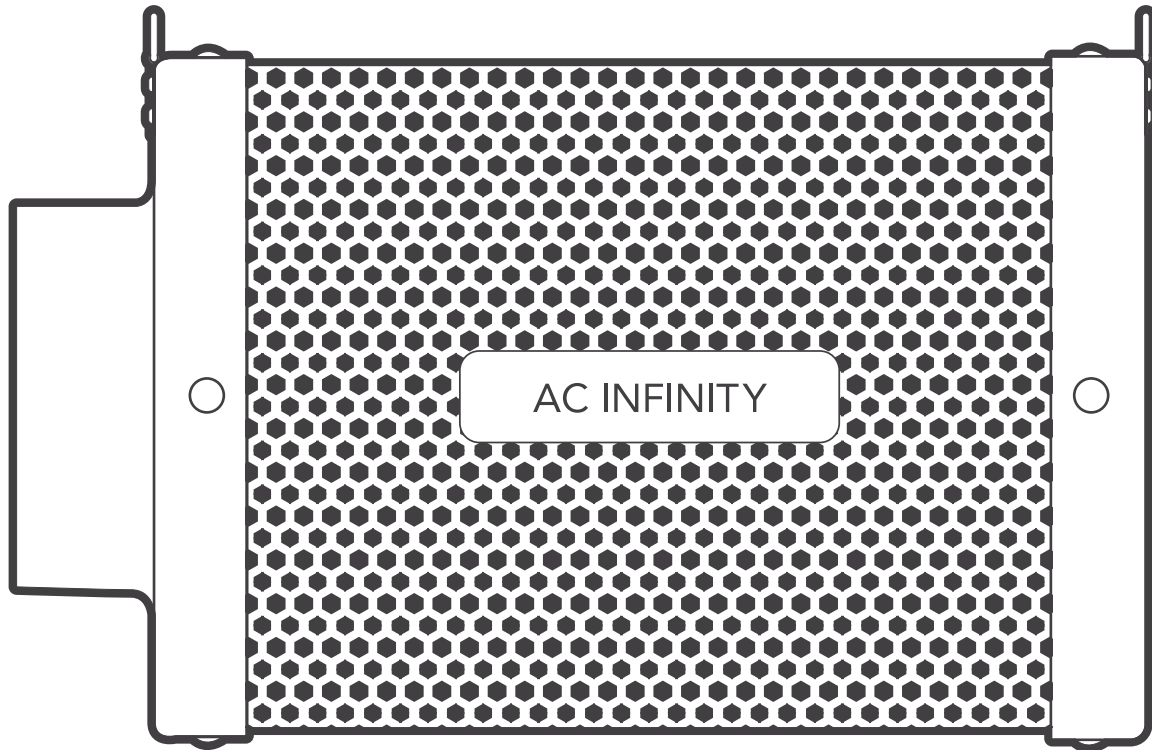



# CARBON FILTER

## PRODUCT CONTENTS

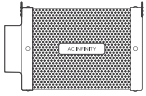
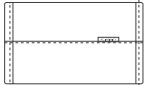
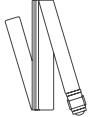
	Advance Grow Tent Kit (2x2) COMPACT AC-PKA22	Advance Grow Tent Kit (2x2) AC-PKB22	Advance Grow Tent Kit (2x4) AC-PKB24	Advance Grow Tent Kit (3x3) AC-PKB33	Advance Grow Tent Kit (4x4) AC-PKB44	Advance Grow Tent Kit (5x5) AC-PKB55
 <p>CARBON FILTER</p>	<p>Inline Carbon Filter, 4 in.</p> <p>x1</p>	<p>Inline Carbon Filter, 4 in.</p> <p>x1</p>	<p>Inline Carbon Filter, 6 in.</p> <p>x1</p>	<p>Inline Carbon Filter, 6 in.</p> <p>x1</p>	<p>Inline Carbon Filter, 6 in.</p> <p>x1</p>	<p>Inline Carbon Filter, 6 in.</p> <p>x1</p>
 <p>PREFILTER CLOTH</p>	<p>4 in.</p> <p>x2</p>	<p>4 in.</p> <p>x2</p>	<p>6 in.</p> <p>x2</p>	<p>6 in.</p> <p>x2</p>	<p>6 in.</p> <p>x2</p>	<p>6 in.</p> <p>x2</p>
 <p>NYLON HANGING STRAPS</p>	<p>x2</p>	<p>x2</p>	<p>x2</p>	<p>x2</p>	<p>x2</p>	<p>x2</p>

# CARBON FILTER

## INSTALLATION

### STEP 1

Connect your duct tube over your filter. Use duct clamps to secure the connection. You may also apply ducting tape before using the duct clamps for even further security.

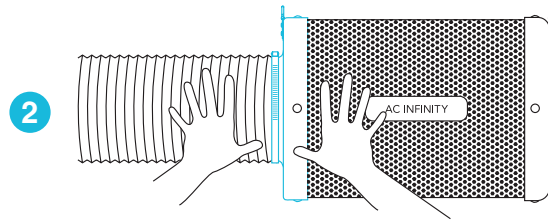
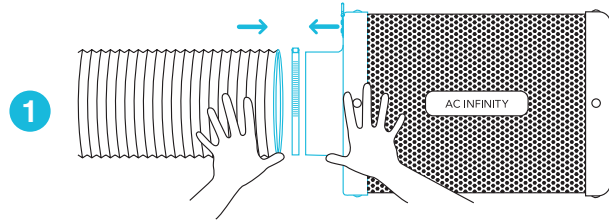

### STEP 2

You may also connect your filter directly to your inline duct fan. Use ducting tape to secure them together.

If your filter is placed in a humid space, position it at the highest point possible.

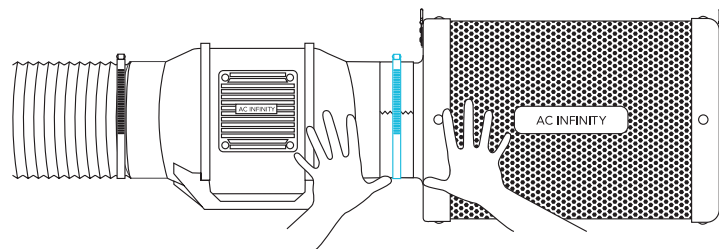
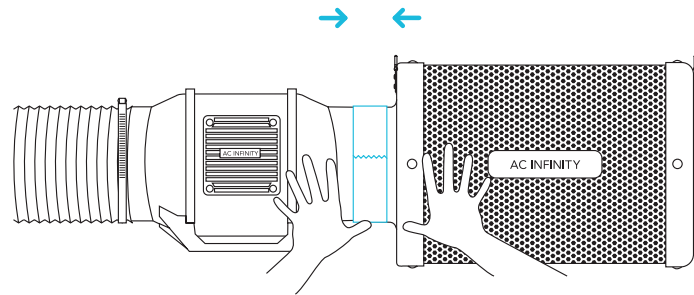

# CARBON FILTER

## OVERHEAD HANGING (STRAPS)

### STEP 1

Loop the strap around a hanging pole.

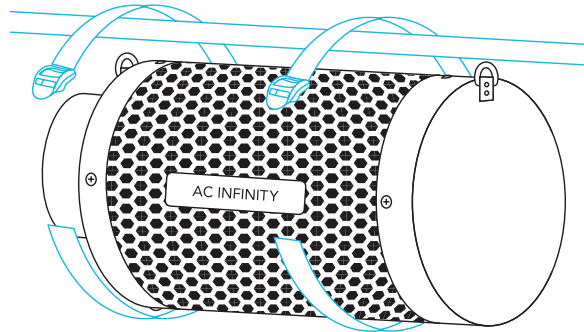

---

### STEP 2

Slip the strap through the inner ladder lock slot from the bottom.

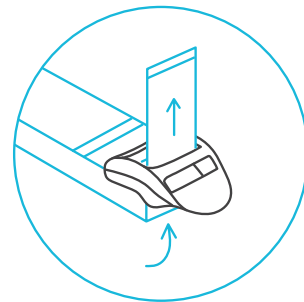

# CARBON FILTER

## OVERHEAD HANGING (STRAPS)

### STEP 3

Route the strap into the outer ladder lock slot from the top. Adjust the length of the completed loop as needed.

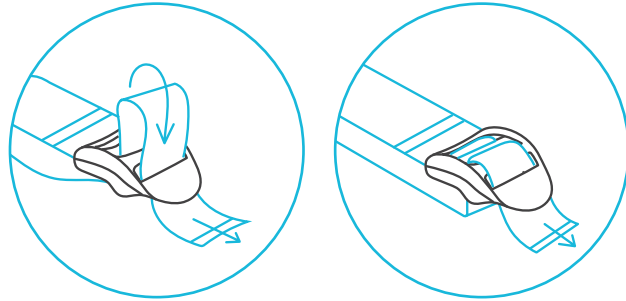

Adjust to size

---

### STEP 4

Tuck the loose ends through the center gap of the ladder lock to secure the loop.

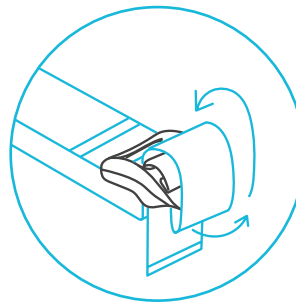

Loop through middle  
to lock in place

# CARBON FILTER

## OVERHEAD HANGING (STRAPS)

### STEP 5

Connect your filter to your ductwork using your preferred method, as shown on page 42.

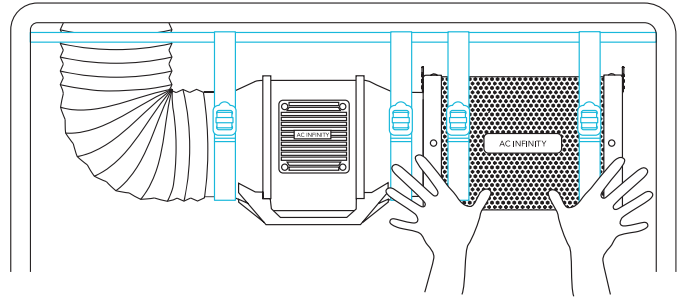

# CARBON FILTER

## OVERHEAD HANGING (ROPE CLIPS)\*

### STEP 1

Loop the rope clip hangers around your grow tent's support beams.

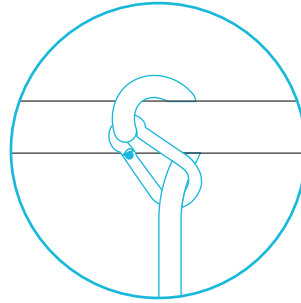

### STEP 2

Hook the carabiners into the steel hooks located on the flanges.

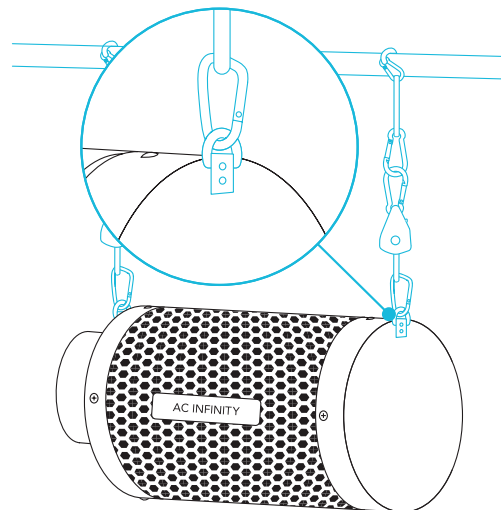

\*Sold separately

# CARBON FILTER

## CONFIGURATION SETUP

### PREFILTER

When placing your filter inside your grow space, slip the cloth over your filter to block dust and other particles from passing through.

Make sure the entire metal mesh is covered by the cloth.

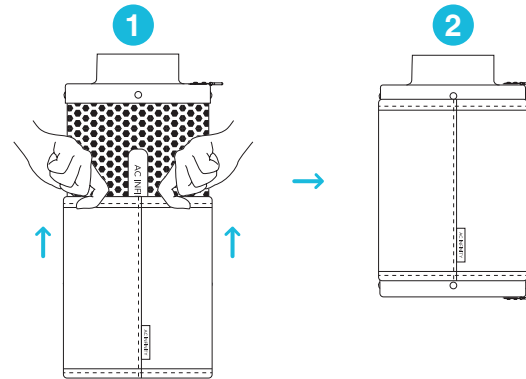

### INTERIOR HANGING

To use this filter in intake applications, place the filter inside your grow space. Make sure your filter is connected to your inline duct fan's intake end before completing the installation.

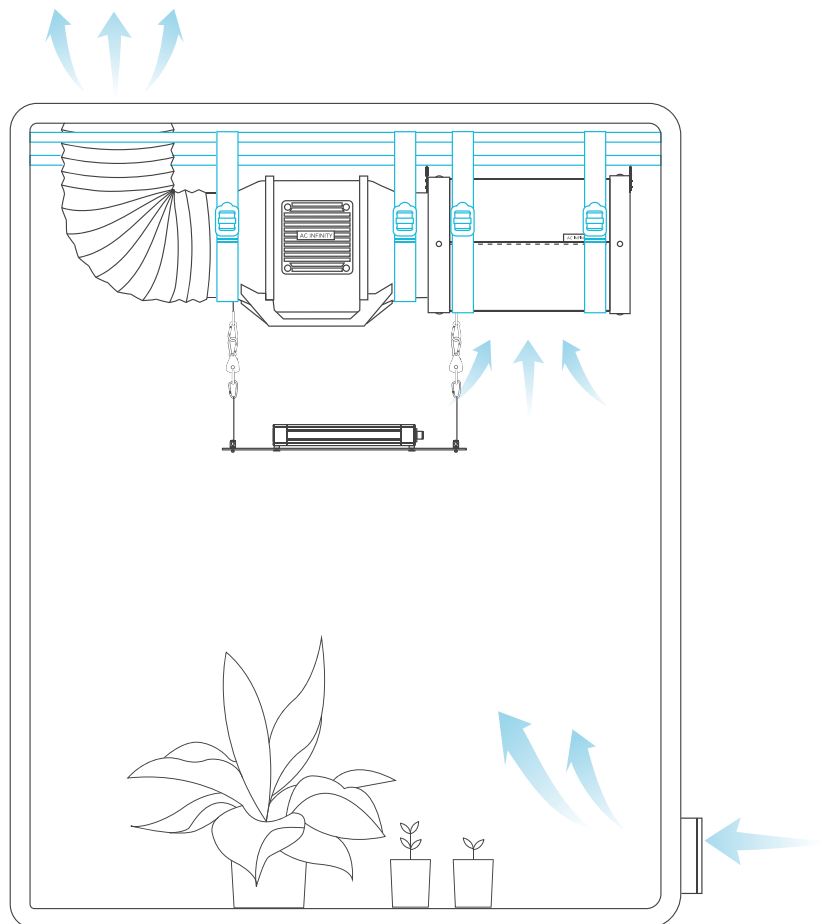

# CARBON FILTER

## CONFIGURATION SETUP

### EXTERIOR MOUNTING

To use this filter in exhaust applications, place the filter outside of your grow space. Make sure your filter is connected to your inline duct fan's exhaust end before completing the installation. Stuff the prefilter inside of the filter to lengthen the carbon bed's lifespan.

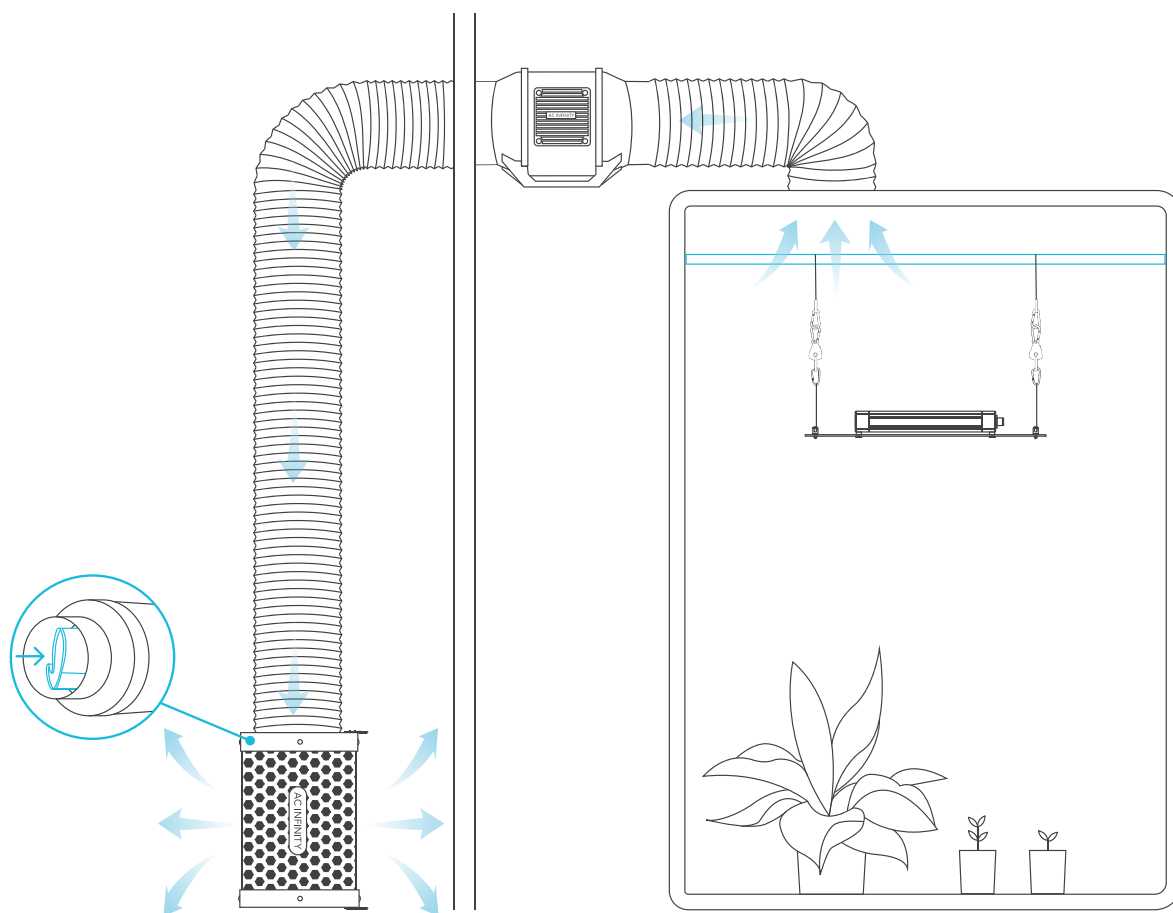



# CARBON FILTER

## CONFIGURATION SETUP

### OVERSIZED GROW SPACE

Use a dual fan and filter combination inside your grow space to completely scrub away odor in larger grow rooms and tents. Set the secondary filter on the floor and the inline fan on top of it so that the exhaust end points up.

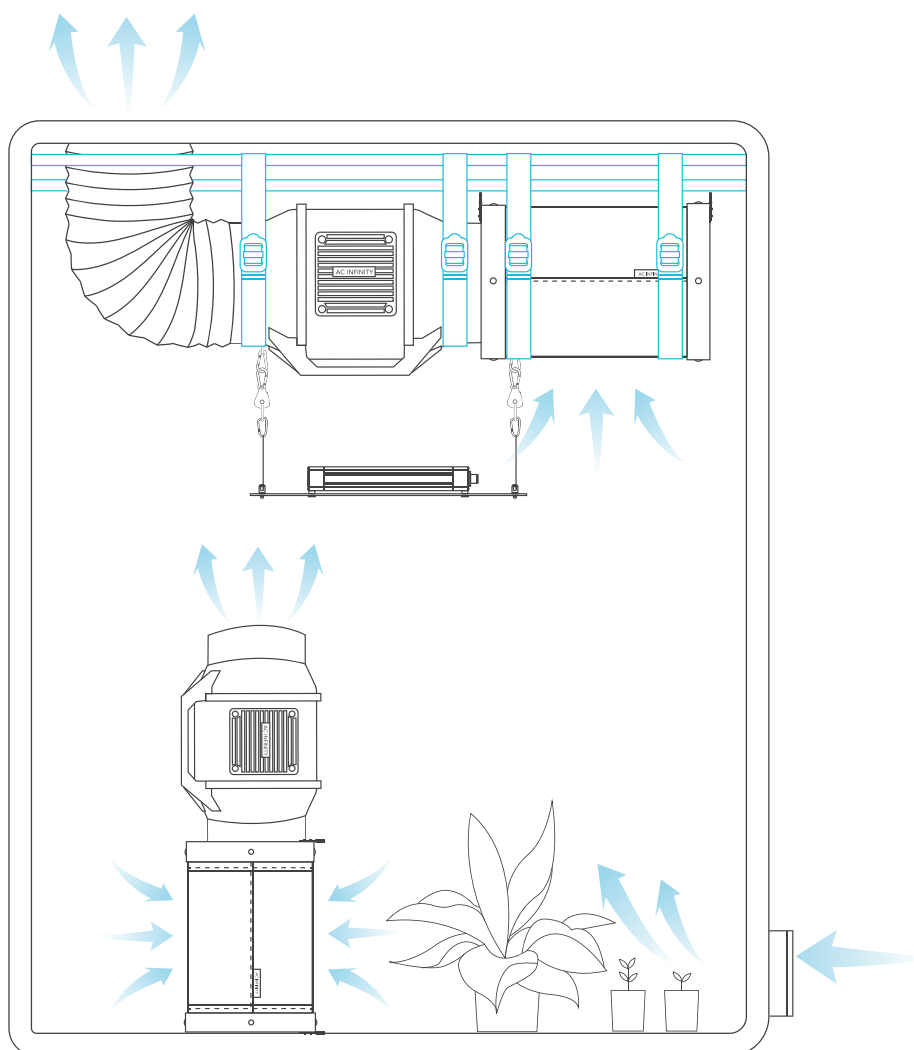

# CARBON FILTER

## MAINTENANCE

### REVERSING THE FLANGES

To extend the filter's lifespan and utilize its entire carbon bed, rotate the flanges from either end.

Remove the screws from the flanges to release them from the filter. Replace the flanges on the other ends and screw them back into place.

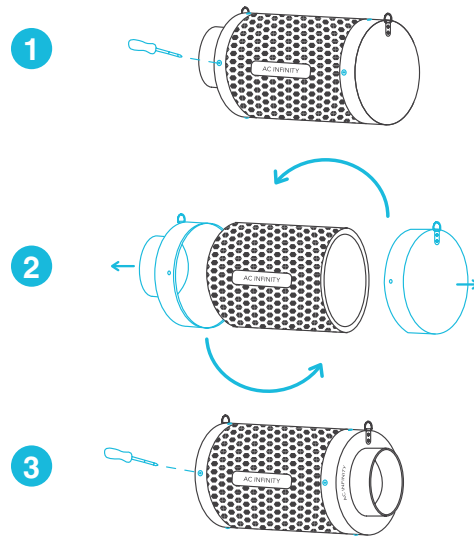

---

### WASHING THE PREFILTER

Wash the reusable cloth as needed to clear it of any dust and build-up. This will further extend the lifespan of the filter.

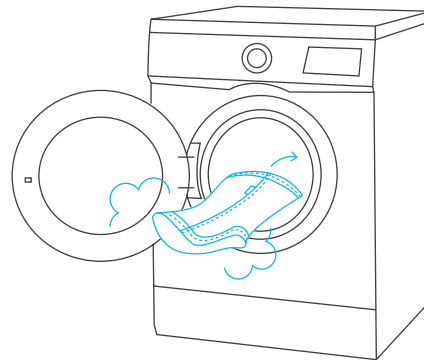



# IONBOARD / IONFRAME EVO

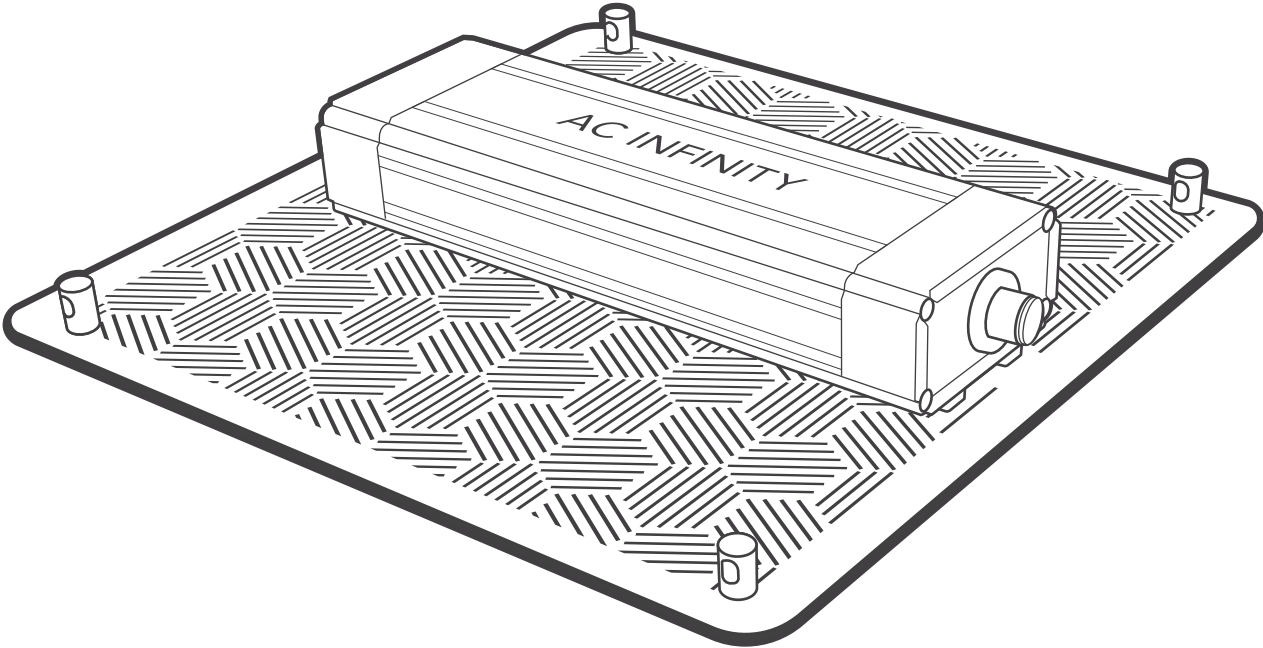

## GROW LIGHT SYSTEM



IONBOARD S22 shown



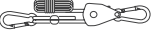
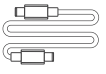

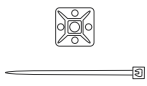

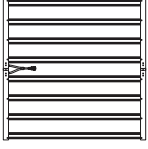
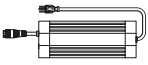
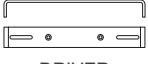

# GROW LIGHT SYSTEM

## PRODUCT CONTENTS: IONBOARD

	Advance Grow Tent Kit (2x2) COMPACT AC-PKA22	Advance Grow Tent Kit (2x2) AC-PKB22	Advance Grow Tent Kit (2x4) AC-PKB24	Advance Grow Tent Kit (3x3) AC-PKB33	Advance Grow Tent Kit (4x4) AC-PKB44
 LED GROW LIGHT	IONBOARD S22, 2x2 Coverage x1	IONBOARD S22, 2x2 Coverage x1	IONBOARD S24, 2x4 Coverage x1	IONBOARD S33, 3x3 Coverage x1	IONBOARD S44, 4x4 Coverage x1
 ROPE CLIP HANGERS	x2	x2	x2	x2	x2
 CONTROLLER CORD	UIS Male-Male Controller Cord x1	UIS Male-Male Controller Cord x1	UIS Male-Male Controller Cord x1	UIS Male-Male Controller Cord x1	UIS Male-Male Controller Cord x1
 HANGING HOOK	x2	x2	x2	x2	x2
 WIRE TIE WITH 3M BASE	x1	x1	x1	x1	x1

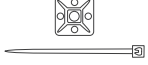
# GROW LIGHT SYSTEM

## PRODUCT CONTENTS: IONFRAME EVO

	Advance Grow Tent Kit (5x5) AC-PKB55
 <p>LED GROW LIGHT</p>	IONFRAME EVO8, 5x5 Coverage x1
 <p>LED DRIVER</p>	x1
 <p>DRIVER BRACKETS</p>	x2
 <p>DRIVER EXTENSION CORD</p>	x1
 <p>STAINLESS STEEL WIRE HANGERS</p>	x2
 <p>ROPE CLIP HANGERS</p>	x2
 <p>CONTROLLER CORD</p>	UIS Male-Male Controller Cord x1
 <p>WIRE TIE WITH 3M BASE</p>	x1
 <p>NYLON SCREWS</p>	x6
 <p>WOOD SCREWS</p>	x4
 <p>DRIVER SCREWS (BRACKET MOUNT)</p>	x4

# GROW LIGHT SYSTEM

INSTALLATION: IONBOARD S22 / S24

## STEP 1

Hang the steel hooks over your grow tent's support beams.

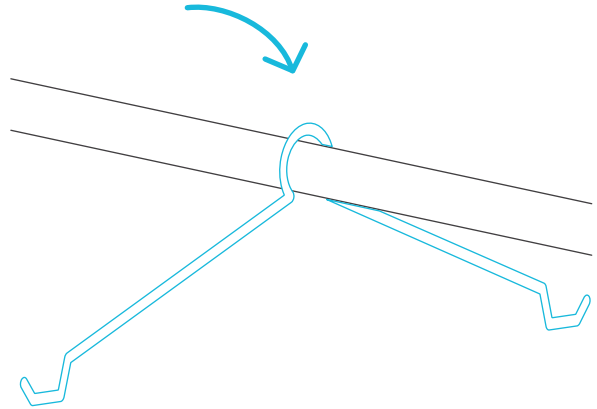

## STEP 2

While supporting your grow light, bend the steel hooks to insert the ends into the slotted holes of the end caps.

Repeat this step on the other side of your grow light.

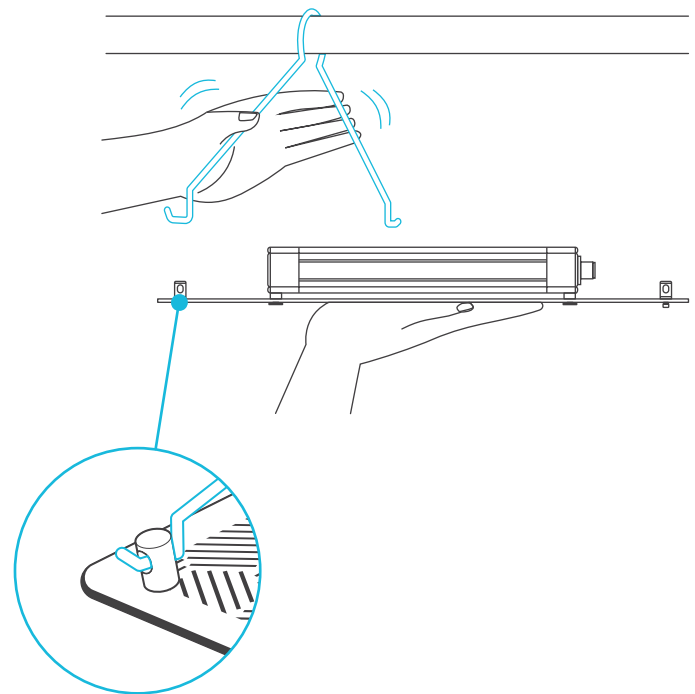

# GROW LIGHT SYSTEM

INSTALLATION: IONBOARD S33 / S44

## STEP 1

Insert the steel hooks into your grow light's slotted holes of the end caps.

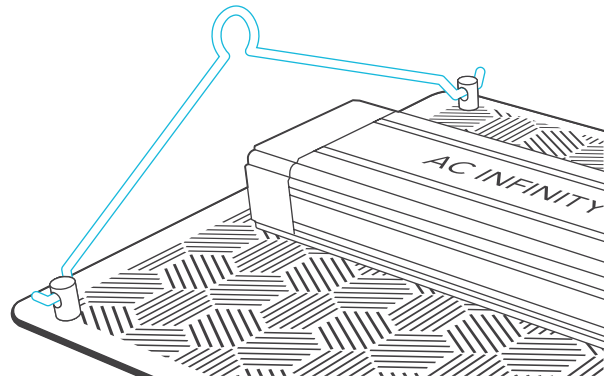

---

## STEP 2

Position your grow tent's pole under the steel hooks. Install the pole onto your grow tent's frame.

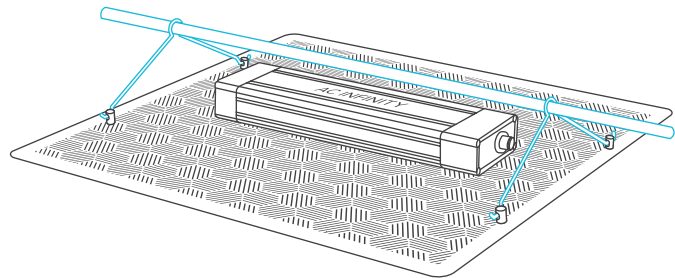

\*Two people are recommended for this installation.



# GROW LIGHT SYSTEM

## DRIVER MOUNTING (FRAME): IONFRAME EVO

### STEP 1

Align the brackets' mounting holes with the driver's mounting points located on the driver's underside, making sure the brackets' legs are pointing up.

Secure the brackets by screwing in the driver screws using a Phillips screwdriver.

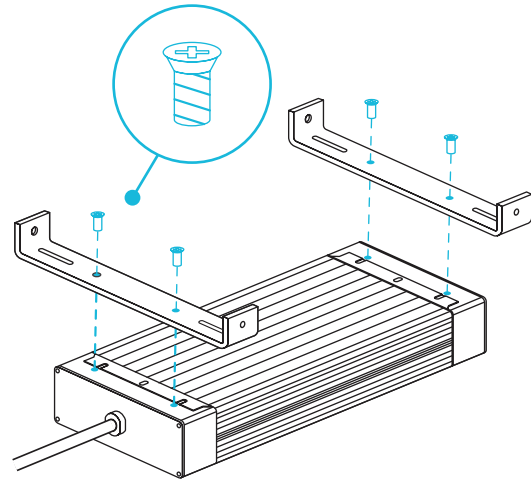

### STEP 2

Flip the driver over and place it over the two center columns of your grow light.

Secure the brackets to the columns by screwing in the nylon screws using a flathead screwdriver.

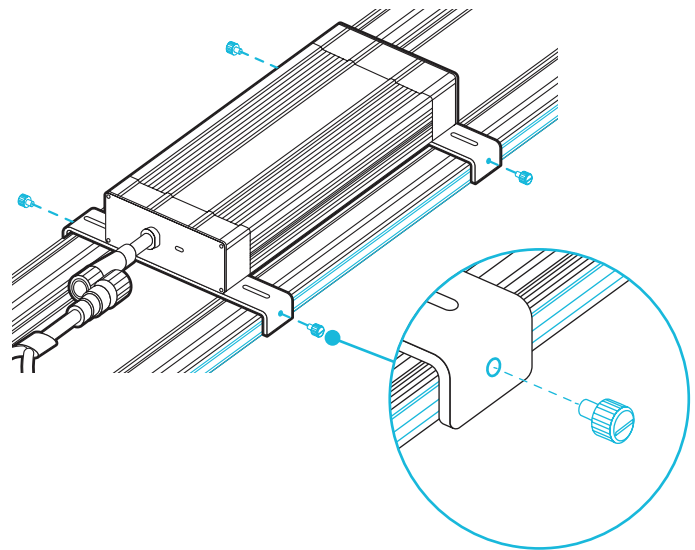

### STEP 3

Connect the driver socket to the grow light connector. This will lock the connection in place.

Twist the lock and pull the connector out to disconnect it from the driver's socket.

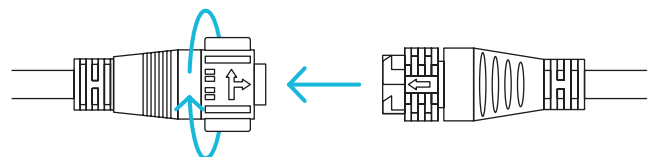

# GROW LIGHT SYSTEM

## DRIVER MOUNTING (WALL): IONFRAME EVO

### STEP 1

Align the brackets' mounting holes with the driver's mounting points located on the driver's underside, making sure the brackets' legs are pointing down.

Secure the brackets by screwing in the driver screws using a Phillips screwdriver.

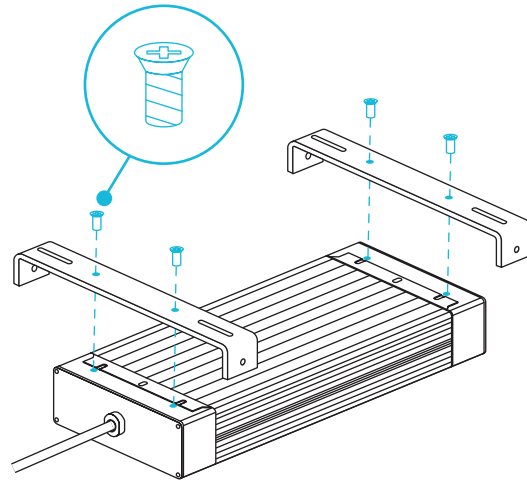

### STEP 2

Mark your desired mounting position using the brackets' mounting slots.

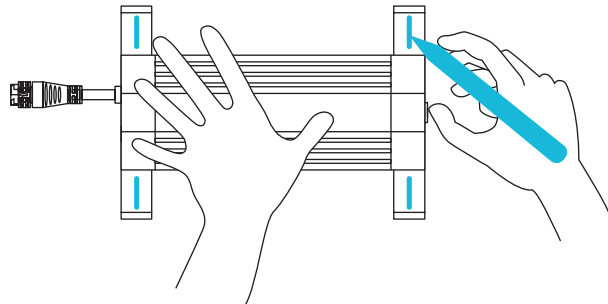

### STEP 3

Drill four holes into the marked locations. Make sure your mounting area is structurally sound and free from obstruction.

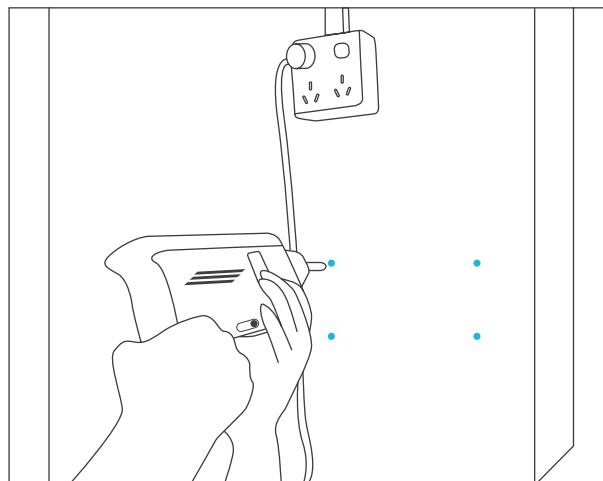

# GROW LIGHT SYSTEM

## DRIVER MOUNTING (WALL): IONFRAME EVO

### STEP 4

If you are mounting onto anything other than a wood support or stud, insert the included four wall anchors into the drilled mounting holes.

You may need to use a hammer to secure them through the holes.

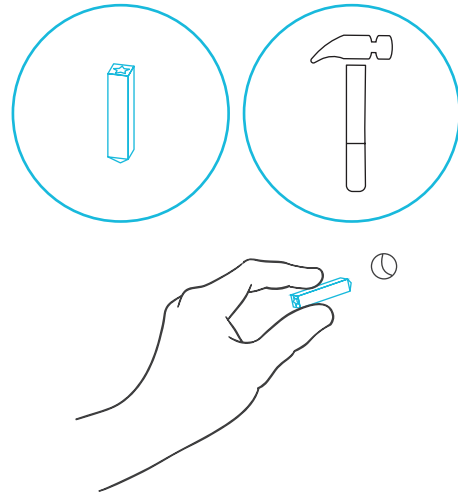

### STEP 5

Align the bracket's holes with the wall anchors. Screw in four wood screws with a screwdriver or drill to secure the brackets.

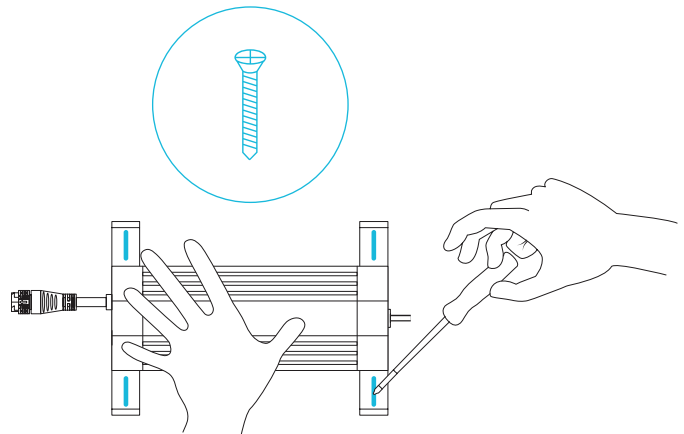

### STEP 6

Connect the driver socket to the grow light connector using the driver extension cord.

Twist the lock and pull the connector to disconnect it from the driver's socket.

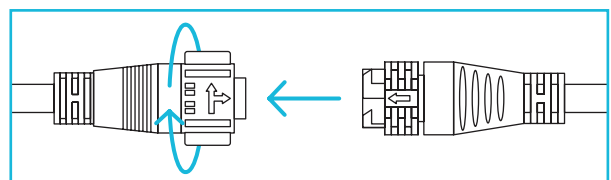

# GROW LIGHT SYSTEM

## HANGING: IONBOARD

### STEP 1

Insert the steel hooks into your grow light's slotted holes of the end caps.

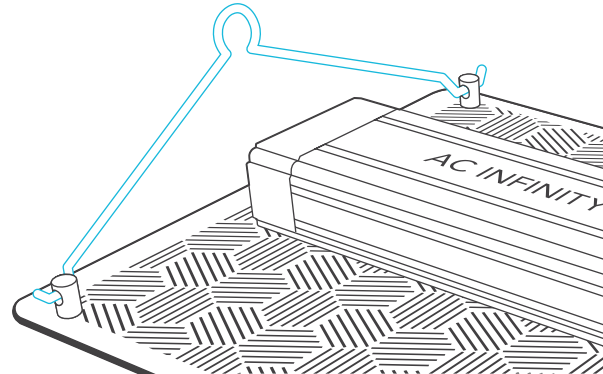

### STEP 2

Loop the rope clip hangers around your grow tent's support beams.

Hook the carabiners into the steel hooks.

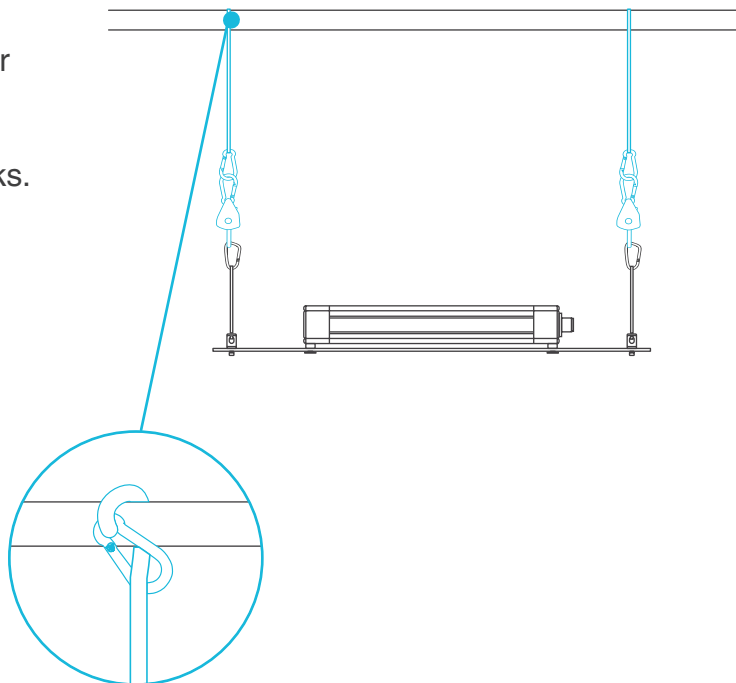

# GROW LIGHT SYSTEM

## HANGING: IONFRAME EVO

### STEP 1

Clip the lanyard hooks onto the four anchors located at the corners of your grow light.

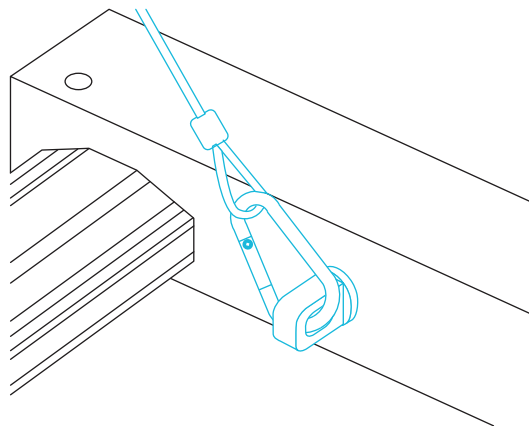

### STEP 2

Clip the two carabiners onto your grow tent's roof support beams.

You may also use rope clip hangers to hang your grow light lower.

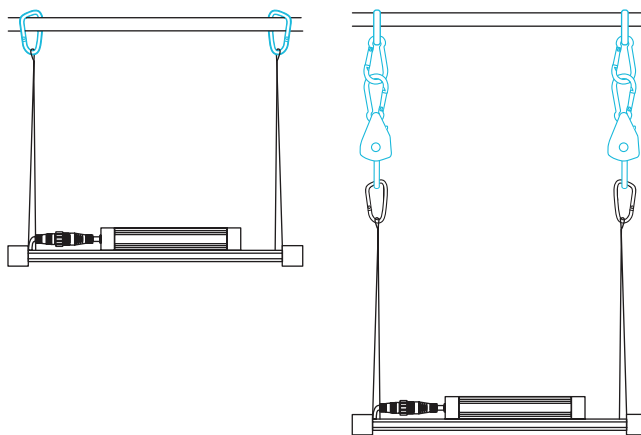

# GROW LIGHT SYSTEM

## POWERING AND SETUP: IONBOARD

### STEP 1

Plug the power cord into an AC power outlet to power your grow light.

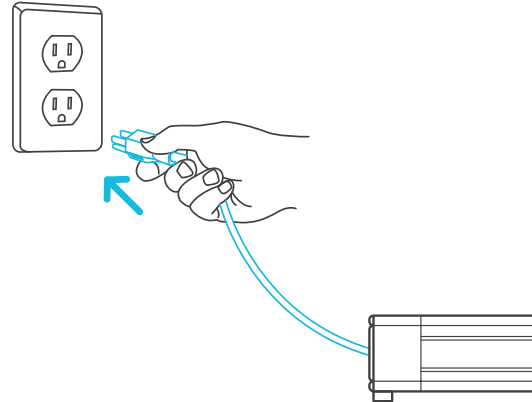

### STEP 2

You may connect an external controller to set smart programming.

Plug one end of the controller cord into the LED driver, and the other end into your chosen controller.

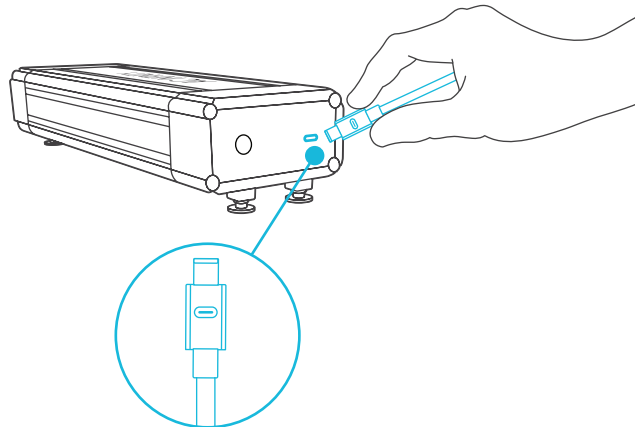

# GROW LIGHT SYSTEM

## POWERING AND SETUP: IONFRAME EVO

### STEP 1

Plug the power cord into an AC power outlet to power your grow light.

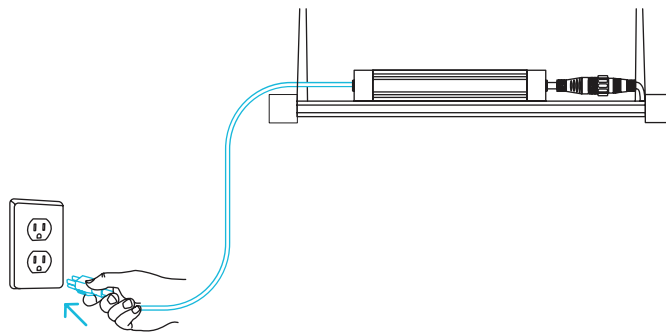

### STEP 2

Plug one end of the UIS extension cord into the LED driver, and the other end into your chosen controller.

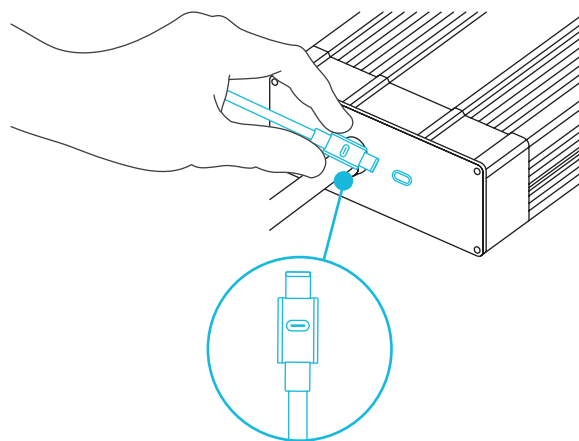

# GROW LIGHT SYSTEM

## STARTER GUIDE: IONBOARD

The charts below offer suggested mounting heights and light intensities for each stage in the growing process of your preferred method. These factors will vary based on the plant you are growing. Height refers to distance from the canopy (tip of the plant).

HEIGHT ADJUSTMENT	Seeding Stage	Vegetative Stage	Flowering Stage
Height	3 ft.	2 ft.	1.5 ft.
Intensity	100%	100%	100%

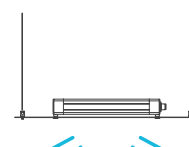
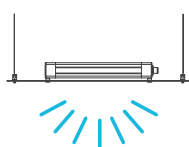
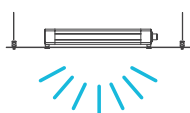

LIGHT ADJUSTMENT	Seeding Stage	Vegetative Stage	Flowering Stage
Height	1.5 ft.	1.5 ft.	1.5 ft.
Intensity	40%	80%	100%

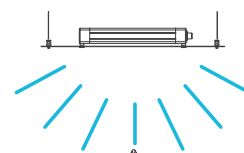
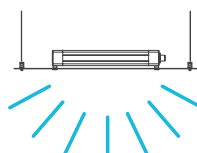
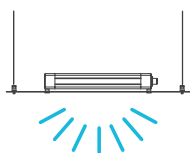



# GROW LIGHT SYSTEM

## STARTER GUIDE: IONFRAME EVO

The chart below lists the coverage area of each grow light size in each growth stage. The supplemental CO<sub>2</sub> column refers to sealed grow spaces that use a CO<sub>2</sub> enrichment system with a 1300+ PPM.

AREA COVERAGE (FT.)	Vegetative Stage	Flowering Stage	Supplemental CO <sub>2</sub>
IONFRAME EVO3	3 x 5	2 x 4	1 x 3
IONFRAME EVO4	4 x 4	3 x 3	2 x 2
IONFRAME EVO6	5 x 5	4 x 4	3 x 3
IONFRAME EVO8	6 x 6	5 x 5	4 x 4
IONFRAME EVO10	7 x 7	6 x 6	5 x 5

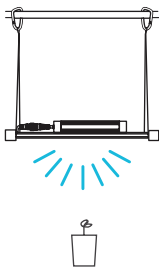
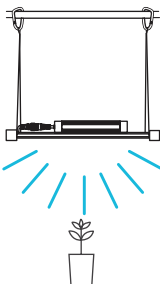
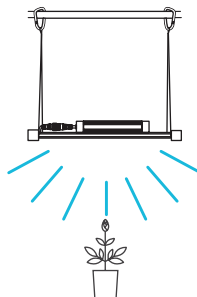

The chart below offers suggested light intensities for each stage in the growing process of your preferred method. These factors will vary based on the plant you are growing.

LIGHT ADJUSTMENT	Seedling Stage	Vegetative Stage	Flowering Stage
Intensity	40%	80%	100%
			

# GROW LIGHT SYSTEM

PROGRAMMING: IONBOARD

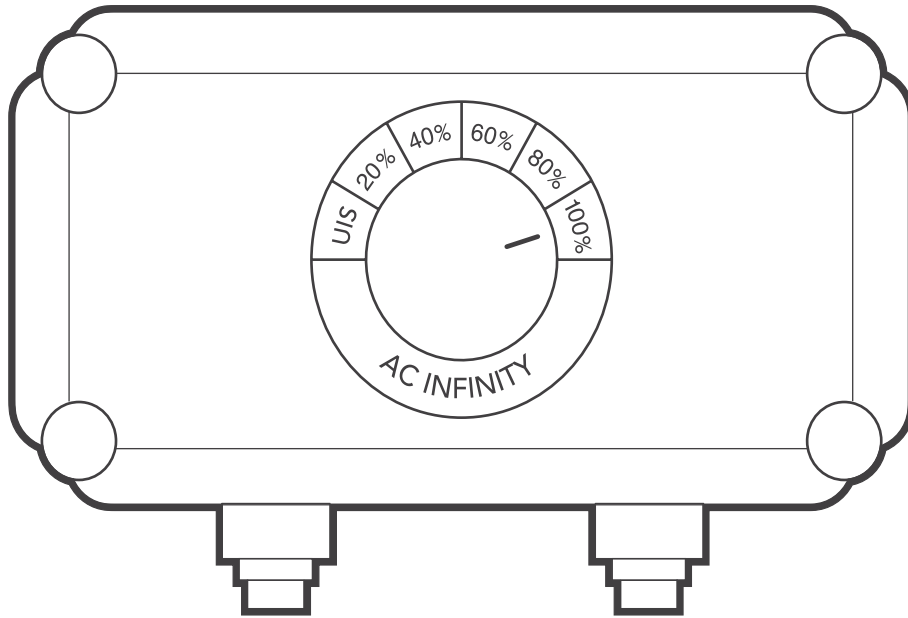

## OFF/ON MODE

Turning the knob to UIS switches the grow light off, or passes control over to your smart controller if one is connected.

---

## INTENSITY LEVEL

Turning the knob from UIS will establish a set light intensity level in 20% increments, up to 100%.



# CLOUDRAY OSCILLATING FAN SYSTEM

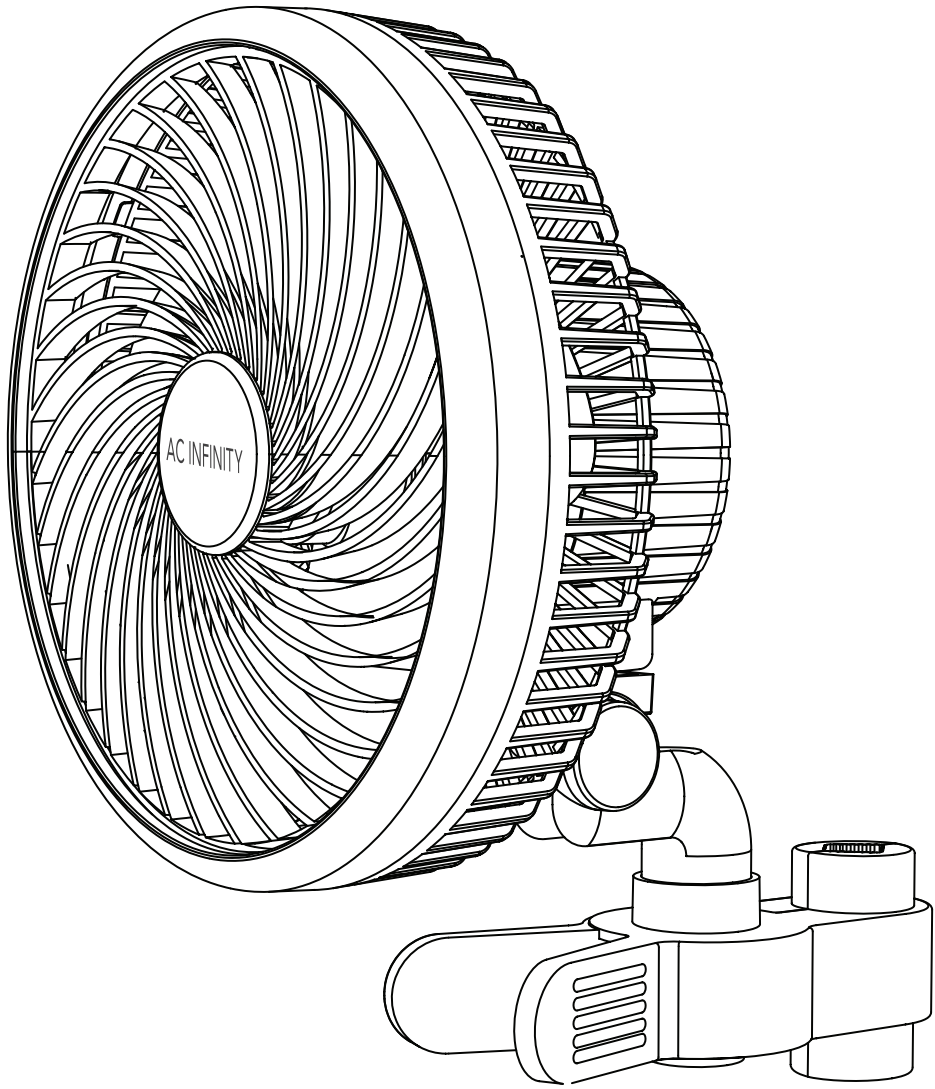

# CLOUDRAY

## PRODUCT CONTENTS

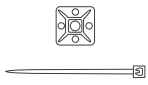
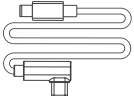
	Advance Grow Tent Kit (2x2) COMPACT AC-PKA22	Advance Grow Tent Kit (2x2) AC-PKB22	Advance Grow Tent Kit (2x4) AC-PKB24	Advance Grow Tent Kit (3x3) AC-PKB33	Advance Grow Tent Kit (4x4) AC-PKB44	Advance Grow Tent Kit (5x5) AC-PKB55
 CLIP-ON FAN	CLOUDRAY S6, Oscillating Clip Fan x1	CLOUDRAY S6, Oscillating Clip Fan x1	CLOUDRAY S6, Oscillating Clip Fan x1	CLOUDRAY S6, Oscillating Clip Fan x1	CLOUDRAY S6, Oscillating Clip Fans x2	CLOUDRAY S6, Oscillating Clip Fans x2
 WIRE TIE WITH 3M BASE	x1	x1	x1	x1	x2	x2
 CONTROLLER CORD	UIS Male-Male Controller Cord, L-Shaped x1	UIS Male-Male Controller Cord, L-Shaped x1	UIS Male-Male Controller Cord, L-Shaped x1	UIS Male-Male Controller Cord, L-Shaped x1	UIS Male-Male Controller Cord, L-Shaped x2	UIS Male-Male Controller Cord, L-Shaped x2

# CLOUDRAY

## RECOMMENDED USAGE

### REDUCING CORD TENSION

Please make sure to provide enough slack for the power cord and the extension cord. The fan should be able to oscillate freely without tugging on its cords.

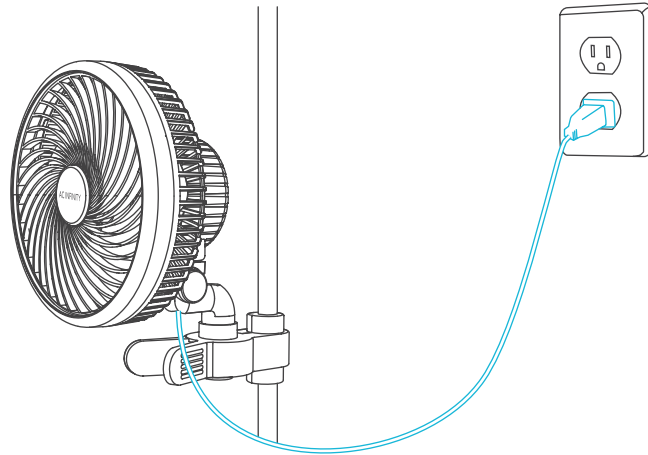

---

### MAXIMIZING LIFESPAN

This fan utilizes the latest in step motor technology that allows it to operate 24 hours a day.

However, to maximize its lifespan, we do not recommend having it oscillate nonstop for more than 18 hours a day.

This will preserve the motor by passively keeping it cool to prevent it from wearing down.

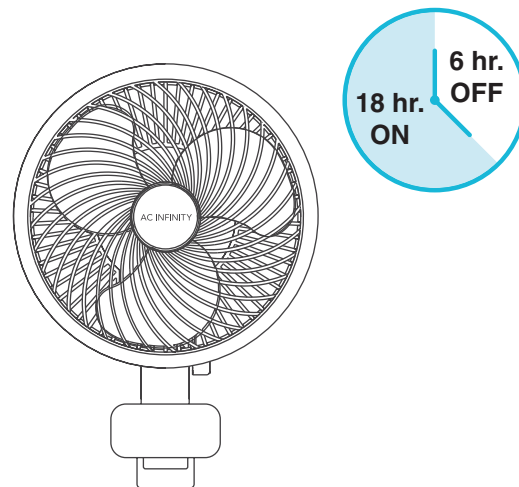

# CLOUDRAY

## INSTALLATION

### STEP 1

Twist to remove the bigger knob piece from the grip clip.

Pull the smaller button piece from the vice grip.

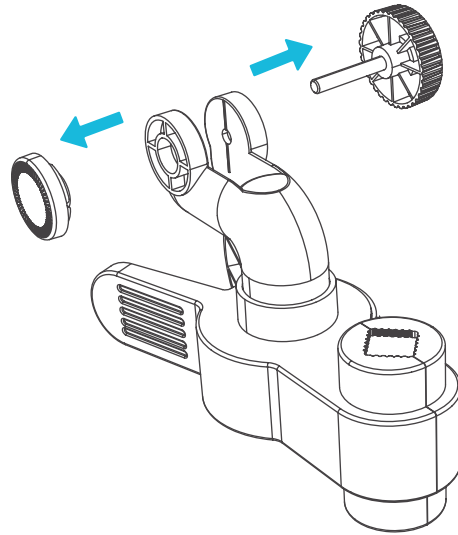

### STEP 2

Slide the grip clip into the swivel as shown.

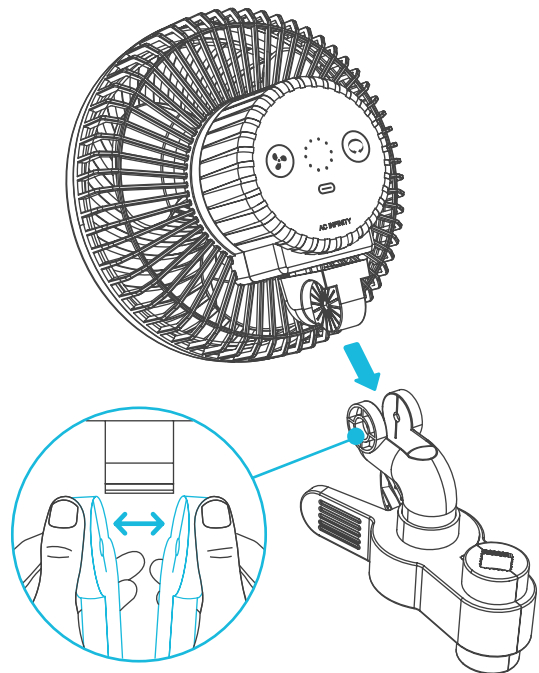

# CLOUDRAY

## INSTALLATION

### STEP 3

Replace the knob and button on either side of the mounting point as desired.

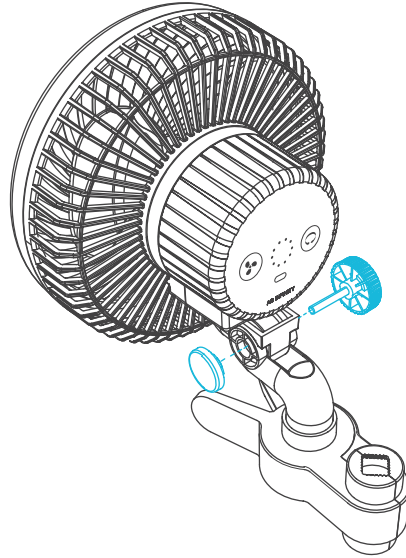

### STEP 4

Clamp the fan onto a pole or post.

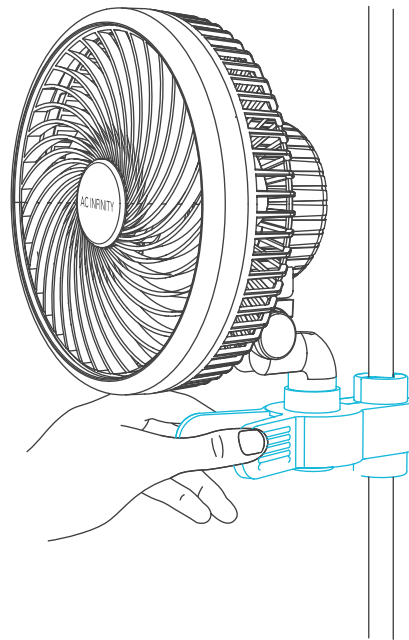



# CLOUDRAY

## INSTALLATION

### STEP 5

Plug the fan's power cord into an AC power outlet to power the fan.

Plug the fan into the closest AC outlet to allow for cable slack and avoid cable tension.

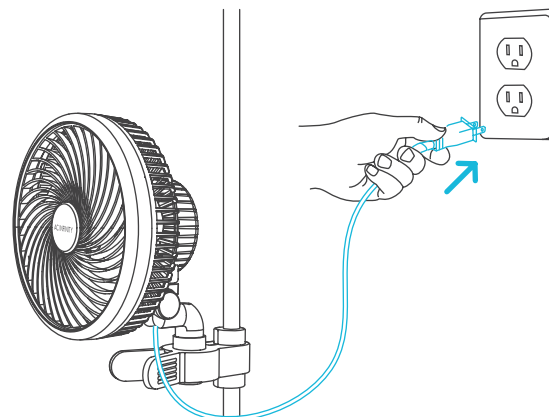

### STEP 6

You may manage the cords using the included cable ties or cable mounting set.

Adhere the tie mount onto a clean surface. Loop the wire tie into the mount and around the cables.

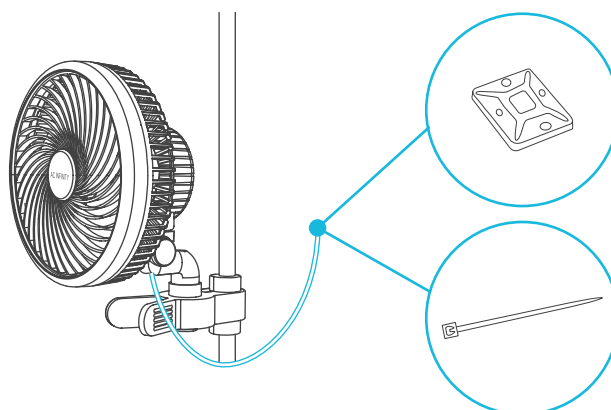

# CLOUDRAY

## CLEANING

### STEP 1

Unplug your clip fan.

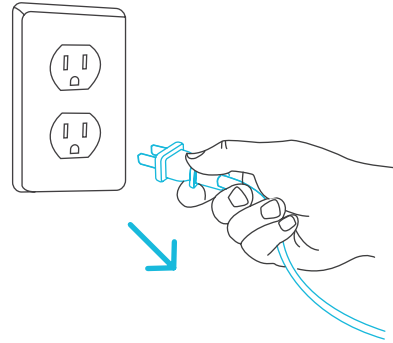

### STEP 2

Remove the front grille by twisting the grille counter-clockwise and pulling it off.

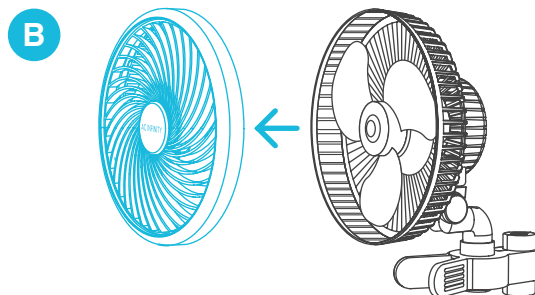
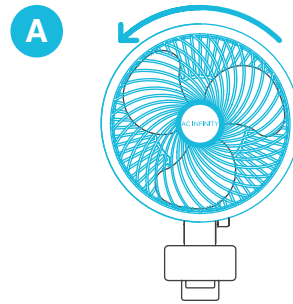

# CLOUDRAY

## CLEANING

### STEP 3

Wipe off any dust and debris from the grille and fan blades using a damp cloth. Set aside to dry as needed.

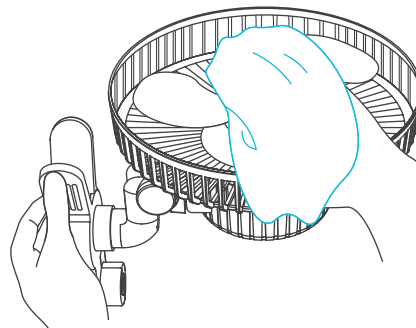

### STEP 4

Realign the grille over your clip fan and twist clockwise to lock it in place.

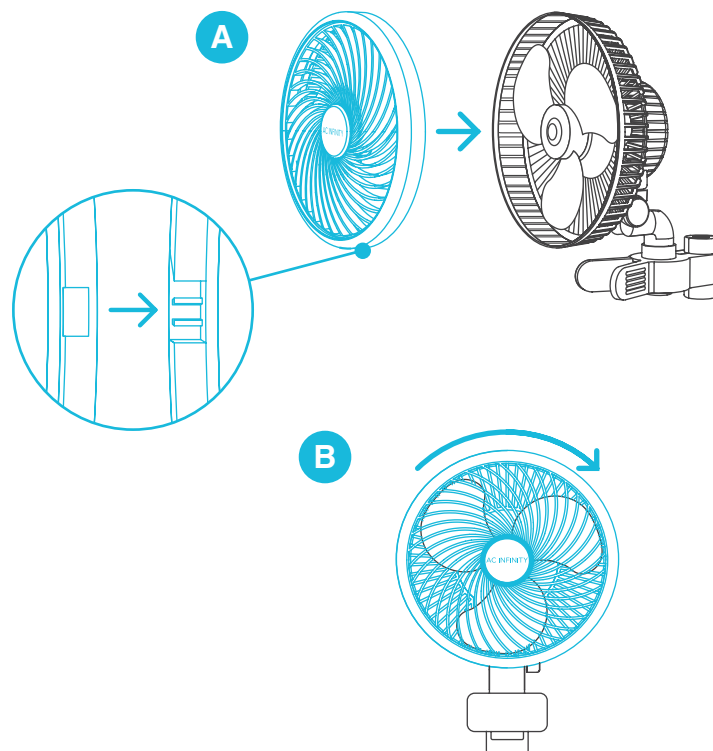

# CLOUDRAY

## PROGRAMMING

### FAN SPEED ADJUSTING

Your clip fan features a button that cycles through the fan speed from 0-10, indicated by the ring of LED lights.

Press the speed button to increase the fan speed level by one.

Pressing the button past speed 10 will cycle the fan speed back to 0.

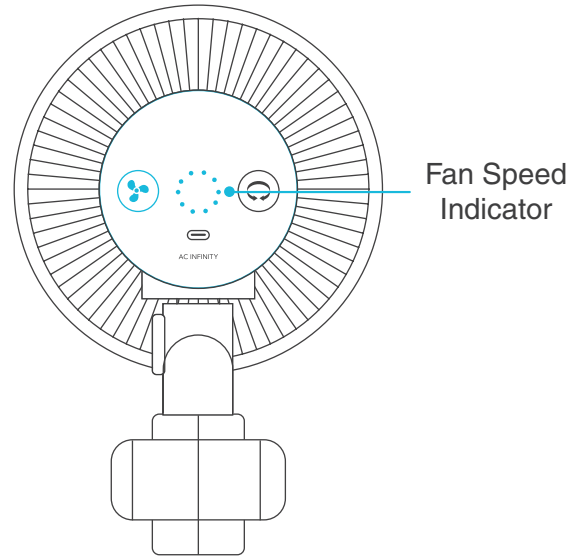

---

### POWERING ON/OFF

Hold the speed button for 4 seconds to turn the fan OFF. Pressing it again from OFF will turn the fan ON at its last speed setting.

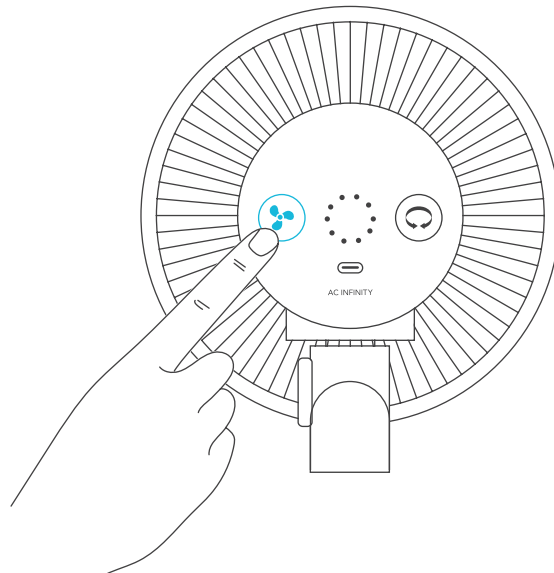

# CLOUDRAY

## PROGRAMMING

### OSCILLATION

In addition to the standard features, S-Series models can oscillate to provide airflow at a wide angle. The oscillation function is manually activated using the oscillation button and cannot be controlled using external UIS programming.

If set to off, your clip fan will not oscillate regardless of any external programs.

If set to on, oscillation will automatically start if the external program activates your clip fan to turn ON. Oscillation will then automatically stop if the external program deactivates your clip fan to turn OFF.

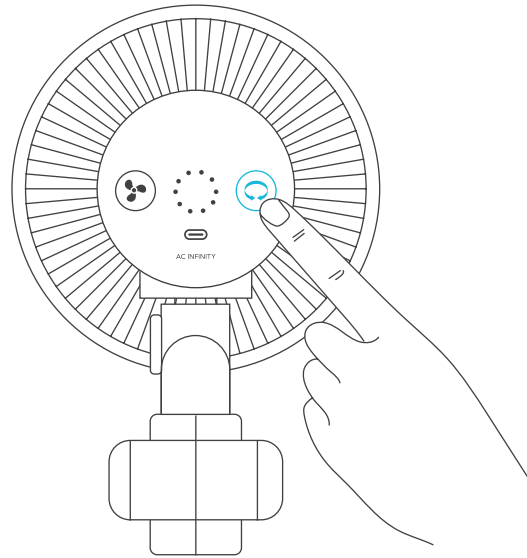

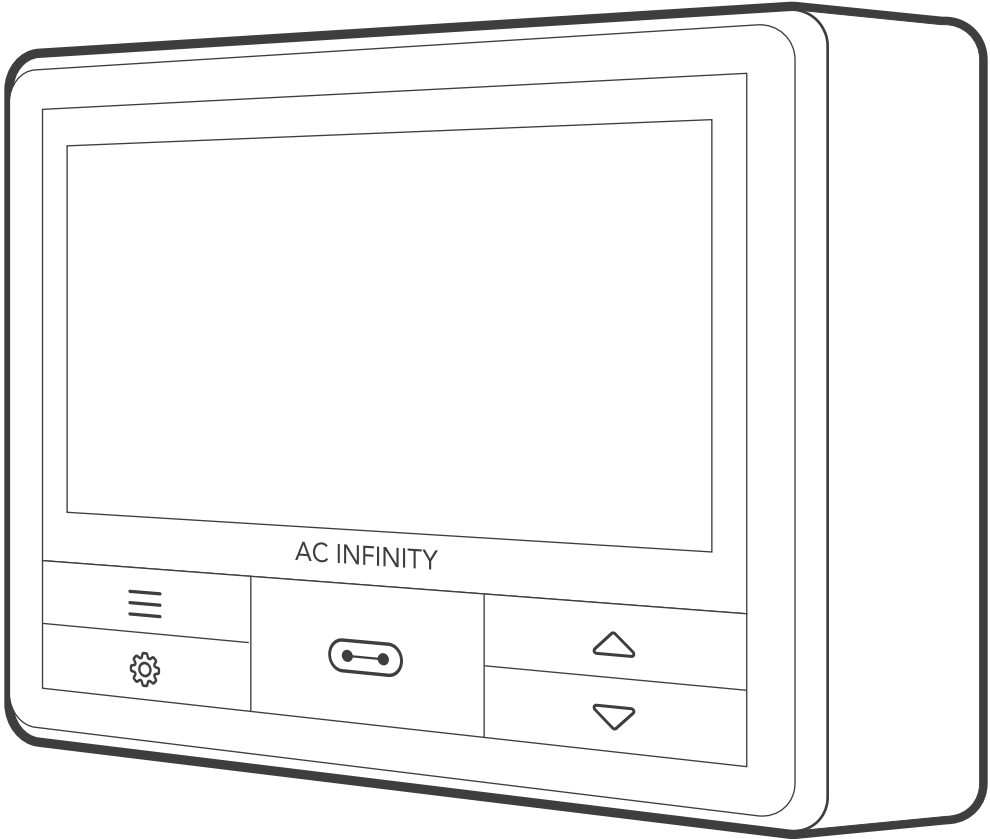

# CONTROLLER 69 PRO

UIS™ MULTI-DEVICE CONTROLLER

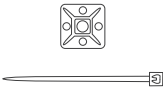
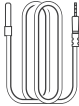

# CONTROLLER 69 PRO

## PRODUCT CONTENTS

	Advance Grow Tent Kit (2x2) COMPACT AC-PA22	Advance Grow Tent Kit (2x2) AC-PKB22	Advance Grow Tent Kit (2x4) AC-PKB24	Advance Grow Tent Kit (3x3) AC-PKB33	Advance Grow Tent Kit (4x4) AC-PKB44	Advance Grow Tent Kit (5x5) AC-PKB55
 <p>GROW TENT CONTROLLER</p>	CONTROLLER 69 PRO, 4 Ports x1	CONTROLLER 69 PRO, 4 Ports x1	CONTROLLER 69 PRO, 4 Ports x1	CONTROLLER 69 PRO, 4 Ports x1	CONTROLLER 69 PRO, 4 Ports x1	CONTROLLER 69 PRO, 4 Ports x1
 <p>WIRE TIE WITH 3M BASE</p>	x1	x1	x1	x1	x1	x1
 <p>TEMPERATURE AND HUMIDITY SENSOR PROBE</p>	x1	x1	x1	x1	x1	x1
 <p>CONTROLLER MOUNTING SCREWS WITH PLASTIC ANCHOR</p>	x2	x2	x2	x2	x2	x2

# CONTROLLER 69 PRO

## POWERING AND SETUP

### STEP 1

Plug your devices' UIS connectors into the following numbered ports:

- Port 1 – **Inline Fan**
- Port 2 – **Grow Light**
- Port 3 – **Clip Fan**
- Port 4 – **Clip Fan** (AC-PKB44 and AC-PKB55 models only).

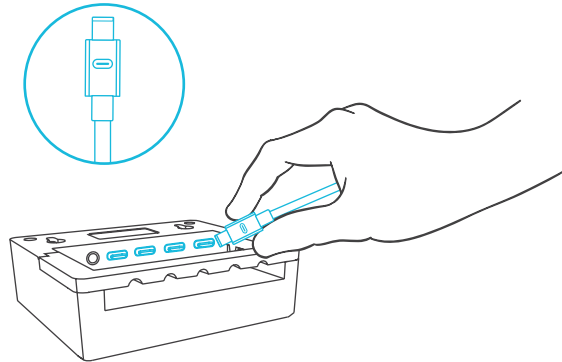

---

### STEP 2

Plug the sensor probe into the controller's 3.5mm jack. Set the probe near your plants in your grow tent for the most accurate reading.

Keep the probe cord away from your HID\* grow light ballast's power cord to ensure the controller properly detects climate conditions.

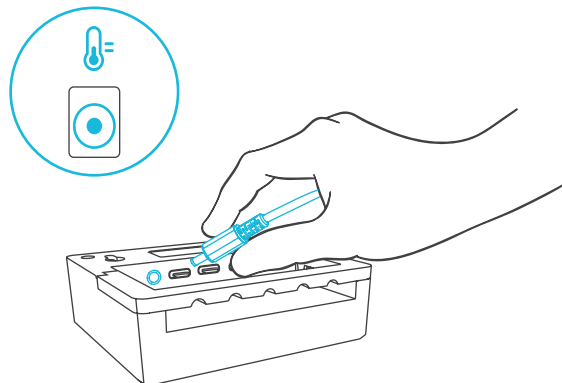

\*MH, HPS, CMH, or CHPS



# CONTROLLER 69 PRO

## POWERING AND SETUP

### STEP 3

Plug your devices' power cord into an AC power outlet to power them and the controller.

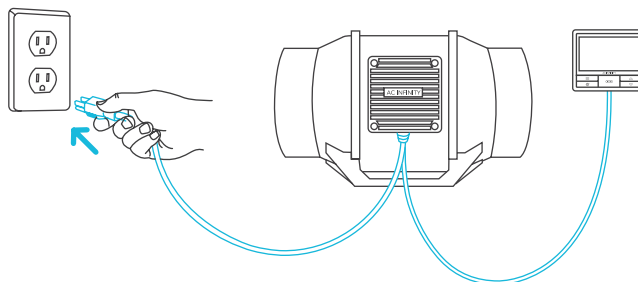

### STEP 4

You may use the included tie mounts, wood screws, and wire ties to manage the cords.

Secure the tie mounts onto a surface using the wood screws. Loop the wire ties around the cords into the tie mounts.

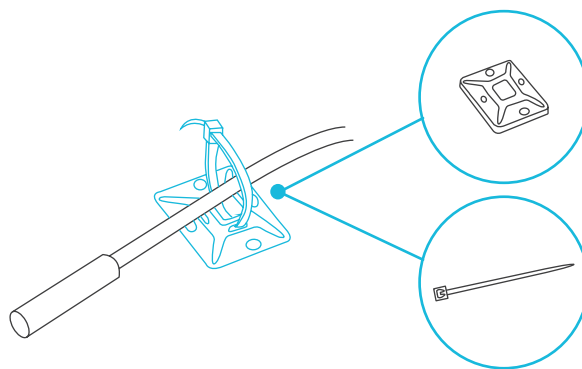

# CONTROLLER 69 PRO

## MOUNTING

### STEP 1 — WALL MOUNTING

Locate a spot free of obstruction and secure the anchors into your wall. Twist the wood screws into the anchors.

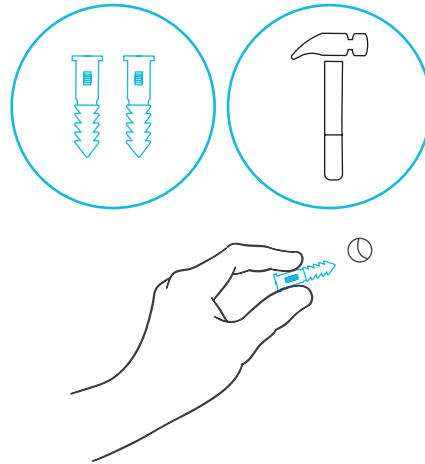

### STEP 2 — WALL MOUNTING

Hang the controller by the screws using the holes on the backside.

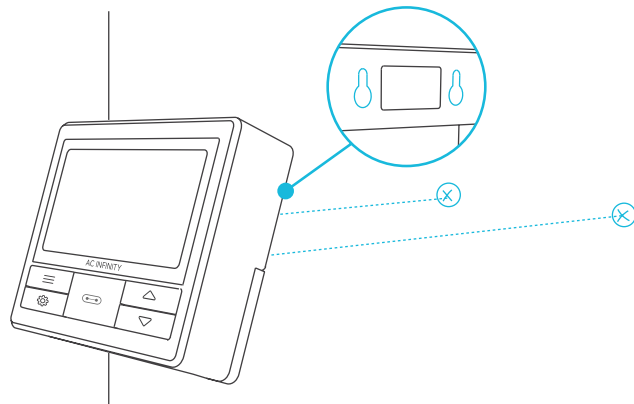

### MAGNET MOUNTING

You may also mount the controller onto a steel surface using the magnet located behind the label.

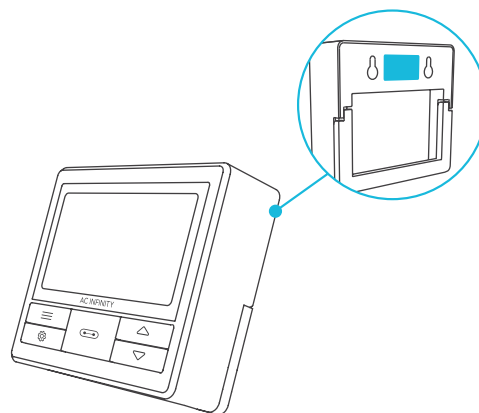

# CONTROLLER 69 PRO

## MOUNTING

### PLATE MOUNTING

Screw the bolts into the slot or mounting holes at the upper half of the plate.

Hang the controller by the bolts using the holes on the backside.

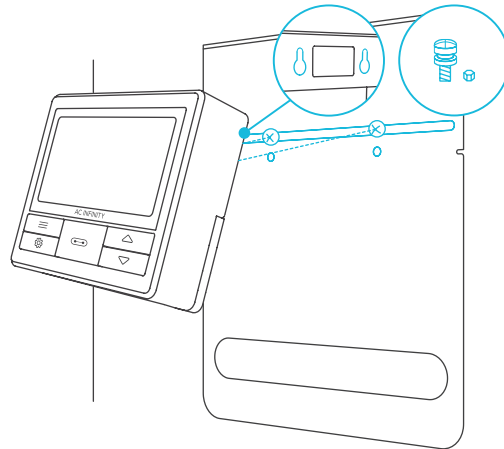

### CORD ARRANGEMENT

Cords may be routed into or outside of the kickstand grooves, and through a cut hole behind the controller.

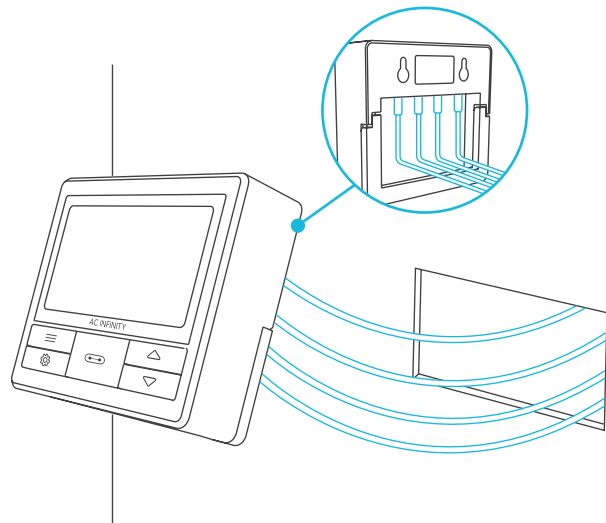

### KICKSTANDING

Open the stand behind the controller to set it tilted on your desktop.

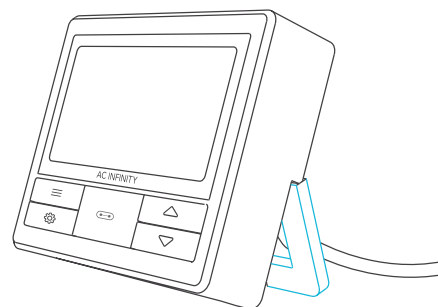

# CONTROLLER 69 PRO

## UIS™ PLATFORM

The UIS™ platform enables you to connect a single central controller with several grow devices simultaneously. By creating this fully integrated system, you can power and program all your devices together or separately for optimized grow tent management.

Your grow system can be regulated using your controller hub or remotely on the AC Infinity app (paired with compatible controllers), where you will have access to automation programming and climate data.

You can also connect your favorite grow light and outlet device to integrate them into the UIS platform using our RJ11/12 adapter and control plug module.

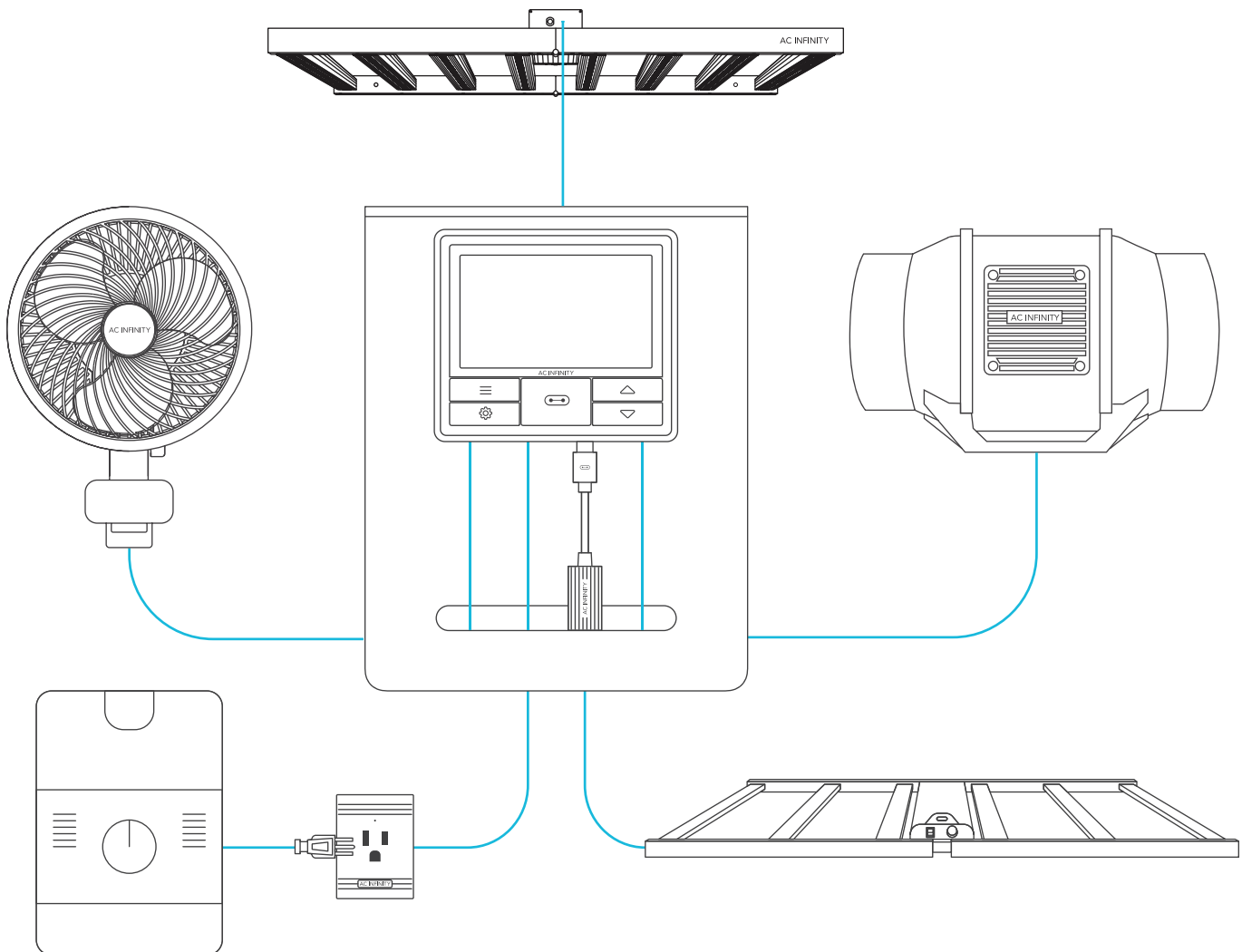

**Grow devices will be sold separately and may still be in development at the time of your purchase of this product.**

# CONTROLLER 69 PRO

## UIS™ COMPATIBILITY

### MOLEX ADAPTER\*

Use a Molex adapter to plug inline fans with 4-pin Molex connectors into this controller. Plug your fan's Molex connector into the adapter. Then plug the adapter into the controller.

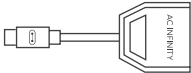

UIS M - 4PIN F  
ADAPTER

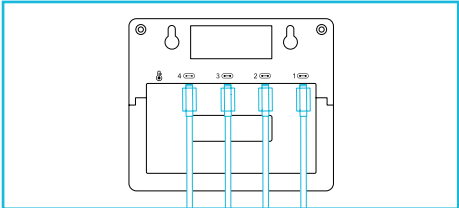

### CONTROLLER CORD

Use male-to-male UIS controller cords to connect devices with female UIS ports at an extended range from your controller.

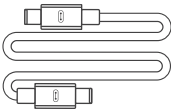

UIS M - M  
CONTROLLER CORD  
(BOX D)

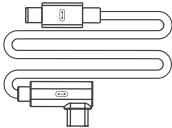

L-SHAPED UIS M - M  
CONTROLLER CORD  
(BOX E)

### 4-PORT SPLITTER\*

The expansion dongle will allow you to connect 4 devices with a single port and can support additional splitters to create up to three tiers of expansion ports. Intended for exclusive use with AC Infinity controllers built with UIS ports.

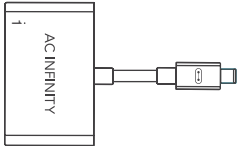

UIS M - M  
4-PORT SPLITTER

\*Not included

# CONTROLLER 69 PRO

## ADDING MORE DEVICES

The CONTROLLER 69 PRO is built with four ports that enable you to power and control multiple devices at the same time. See image below for a sample configuration.

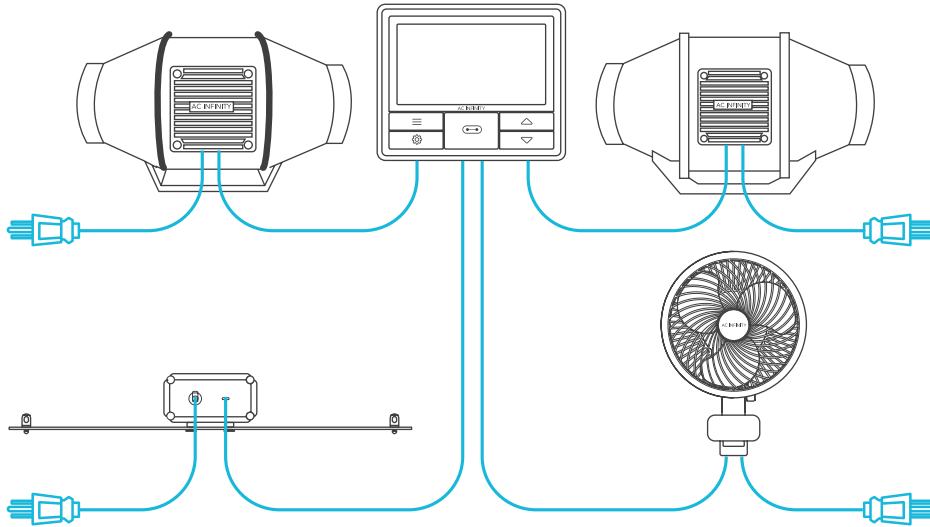

### USING THE DONGLE

When using a 4-port dongle, plug your first device into Port 1 for the controller to recognize as the primary device.

All other devices plugged into the dongle will follow programming intended for the device plugged into Port 1.

### EXTENDING THE CHAIN

When plugging additional dongles into Port 1, all devices plugged into this chain must be of the same type (ex. grow lights of any size) regardless of the length of the dongle chain.

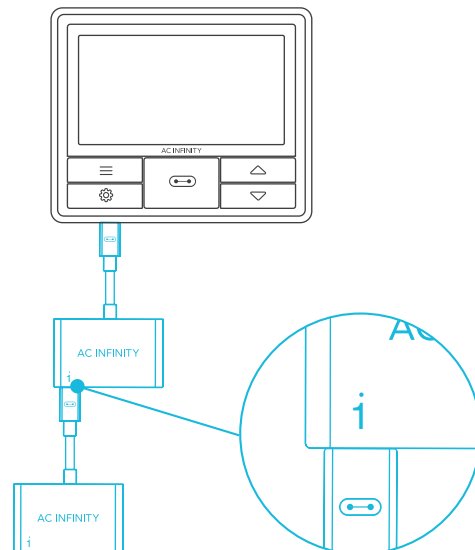
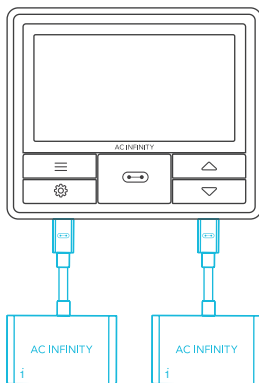

# CONTROLLER 69 PRO

## ADDING MORE DEVICES

### DAISY-CHAINING

Each of the included controller's ports can support up to 20 devices using a daisy-chain adapter (not included). All devices must be from the same series but can be of differing sizes.

Plug the male end of the daisy-chain adapter into your device.

Connect your UIS controller to the daisy-chain adapter's INPUT port using a M-M connector cord. Using an extension cord, attach the daisy-chain adapter's OUTPUT port to another adapter's INPUT port. You can also link the OUTPUT port to another UIS device to end the chain.

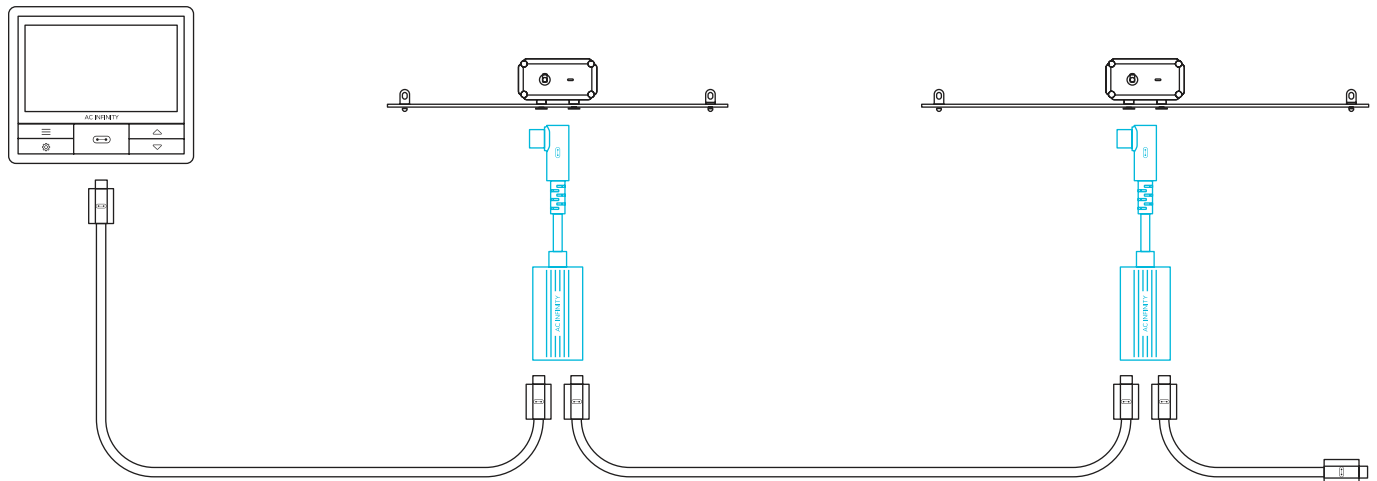
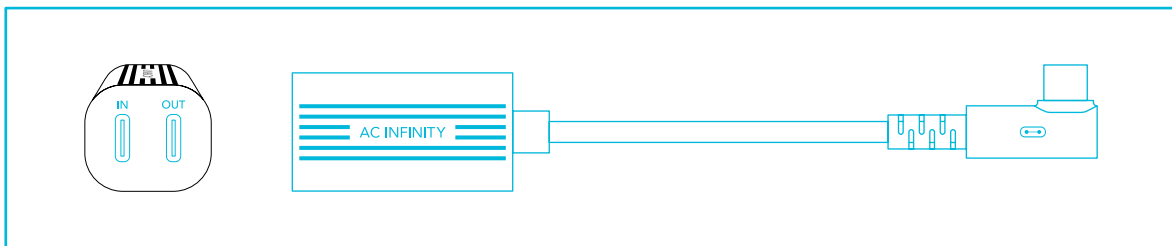

# CONTROLLER 69 PRO

## PROGRAMMING

### 1. PORT BUTTON

Cycles through up to four connected devices. Each device is programmed independently, or together when navigating to ALL.

### 4. UP/DOWN BUTTONS

Adjusts the value of your current mode. The up button increases and down button decreases the setting. Hold both to reset values to OFF/Default.

### 6. PROBE TEMPERATURE

Displays the current temperature that the probe is detecting. Shows "--" if no probe is plugged in. Includes a trend indicator that signals a rise, stability, or fall in temperature within the last hour.

### 8. PROBE VPD

Displays the current VPD that the probe is detecting (in kPa). Shows "--" if no probe is plugged in. Includes a trend indicator that signals a rise, stability, or fall in VPD within the last hour.

### 11. CURRENT LEVEL

Displays the connected devices' current setting. Includes a trend indicator that signals if the setting is currently rising, falling, or holding steady.

### 2. MODE BUTTON

Cycles through the controller's modes: OFF, ON, AUTO (4 triggers), VPD (2 triggers), TIMER TO ON, TIMER TO OFF, CYCLE (ON and OFF), and SCHEDULE (ON and OFF).

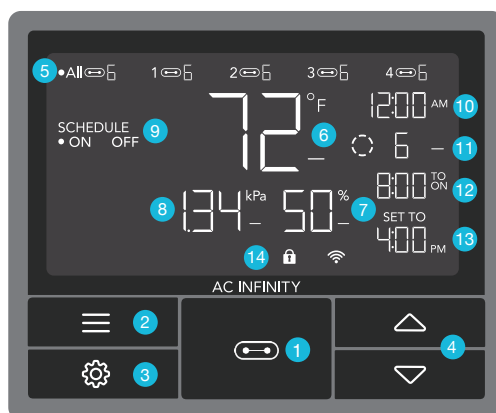

### 9. CONTROLLER MODE

Displays the controller's current mode. Pressing the mode button cycles through the available modes.

### 12. COUNTDOWN

Displays the countdown of the TIMER TO ON, TIMER TO OFF, CYCLE, or SCHEDULE mode activates or deactivates the devices. TO ON shows the amount of time left before the devices turn on. TO OFF shows the amount of time left before the device turn off.

### 3. SETTING BUTTON

Cycles through the controller's settings: DISPLAY, CLOCK, °F / °C, CALIB. T° / H% / kPa, TRANS. T° / H% / kPa, BUFF. T° / H% / kPa, and LEAF OFFSET.

### 5. PORTS

Displays all connected devices as well as their current level. Digits are displayed by the UIS symbol when a device is plugged into its corresponding port.

### 7. PROBE HUMIDITY

Displays the current humidity that the probe is measuring. Shows "--" if no probe is plugged in. Includes a trend indicator that signals a rise, stability, or fall in humidity within the last hour.

### 10. CURRENT TIME

Displays the current time. The internal battery sustains the clock so it does not default to 00:00 if power is cut off.

### 13. USER SETTING

Displays the value of your current mode. Use the up or down buttons to adjust the value.

### 14. ALERT ICONS

Displays alerts and statuses of the controller, including the controller lock, CLIMATE alert, and TIMER alert.



# CONTROLLER 69 PRO

## PROGRAMMING

### PORTS

Pressing the port button will cycle through the controller's available ports: ALL, 1, 2, 3, and 4. Dot indicates the current device. No digit is displayed if a device is not plugged into the corresponding port.

The controller is pre-programmed with the following settings:

- Port 1 – **Inline Fan** set to Fan Speed Level 5 scheduled between 6:00pm and 12:00pm, and to Level 2 scheduled between 12:00pm and 6:00pm.
- Port 2 – **Grow Light** set to Brightness Intensity Level 10 scheduled between 6:00pm and 12:00pm and to Level 0 scheduled between 12:00pm and 6:00pm.
- Port 3 – **Oscillating Fan** set to Level 5.
- Port 4 – **Oscillating Fan** set to Level 5 (if applicable).

### ALL PORTS

Navigate to the ALL port to set simultaneous programming for all connected devices.

Programming set in this port mode applies to all connected devices, but will not be active if you navigate to other ports. Re-entering the ALL port will resume its programming.

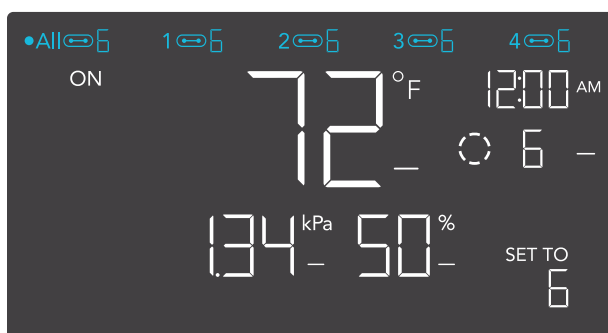

### INDIVIDUAL PORT

Navigate to a numbered port with a connected device to set individual programming.

Programming will run in the background even while you navigate to other numbered ports.



# CONTROLLER 69 PRO

## PROGRAMMING

### CONTROLLER MODES

Pressing the mode button will cycle through the controller's available programming modes: OFF, ON, AUTO (4 triggers), VPD (2 triggers), TIMER TO ON, TIMER TO OFF, CYCLE (On and Off), and SCHEDULE (On and Off).

### OFF MODE

Your devices will not run while in this mode. The OFF Mode setting also serves as the minimum level the other modes will run at while triggered OFF.

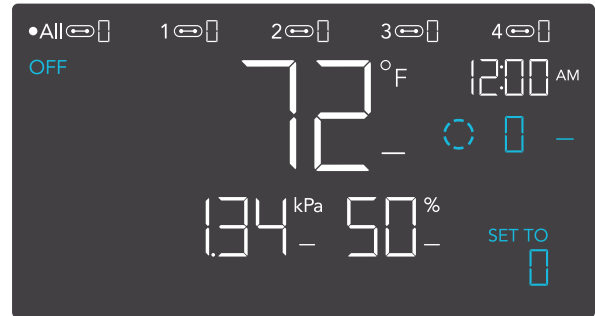

### MINIMUM LEVEL

Your devices will run at the level set in OFF Mode, as the minimum level, when triggered to turn OFF. These other modes include the AUTO Mode, CYCLE Mode, TIMER TO ON Mode, TIMER TO OFF Mode, and SCHEDULE Mode.

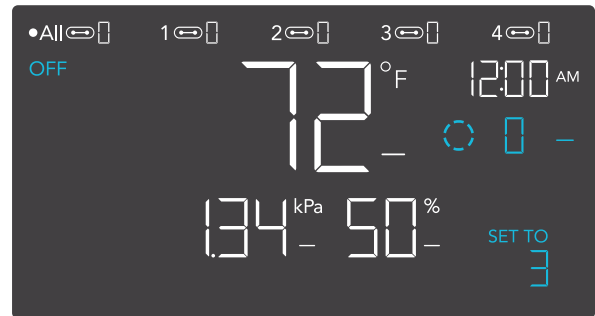

\*Example shown

They will run continuously until triggered ON, at which point they will run at the level set in ON Mode.

If you want your devices to turn off completely when they're triggered to be OFF, set the OFF Mode level to zero.

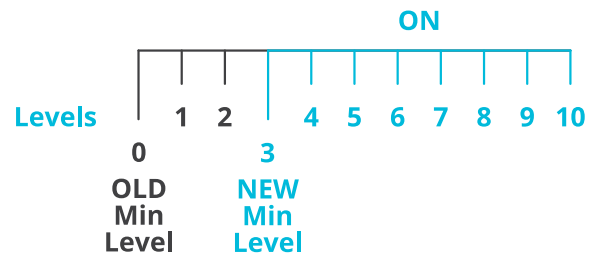

# CONTROLLER 69 PRO

## PROGRAMMING

### ON MODE

Your devices will actively run at the level set here, regardless of the probe's reading. The ON Mode setting also serves as the maximum level the other modes will run at.



\*Example shown

### MAXIMUM LEVEL

Your devices will run at the level set in ON Mode, as the maximum level, when triggered ON, as well as in the AUTO Mode, CYCLE Mode, TIMER TO ON Mode, TIMER TO OFF Mode, and SCHEDULE Mode.

Do not set the ON Mode figure to zero or your devices will turn off when it's triggered ON in all modes.

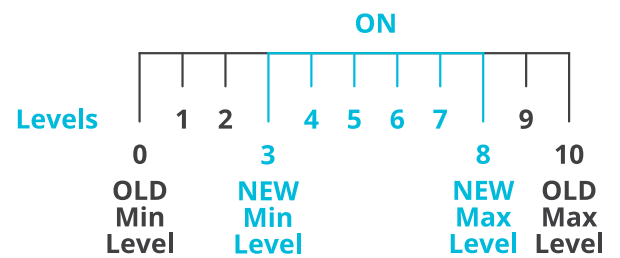

# CONTROLLER 69 PRO

## PROGRAMMING

### AUTO MODE (HIGH TEMPERATURE TRIGGER)

Pressing the up or down button sets the high temperature trigger. The devices will activate if the probe's reading meets or exceeds this threshold.

Once triggered, the devices will gradually ramp up to the level set in ON mode. If the probe's reading falls below this trigger point, the devices will gradually slow down to a stop or at the level set in OFF mode.

You may set this trigger below the low temperature trigger to create a specific range in which the devices are active.

This is typically used with devices like air conditioners and cooling fans to help lower the temperature when it gets too hot. For example, if you set a high temperature trigger of 70°F, then your device will activate when the temperature reaches 70°F or higher, and turn off when it falls below 70°F. Products shown here may still be in development.

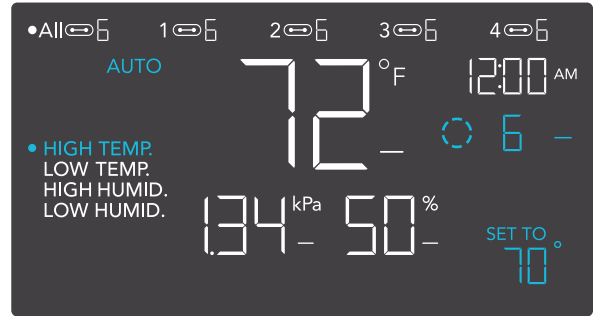

Any of the four trigger points can activate while you are in AUTO Mode, even if you are viewing another trigger point. Please set a trigger point to OFF if not in use, by holding down the up and down button. If there is a level set in OFF Mode other than zero, the devices will run at that level when triggered to turn off.

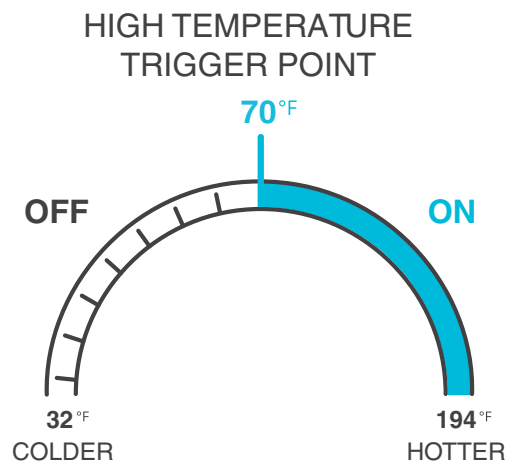
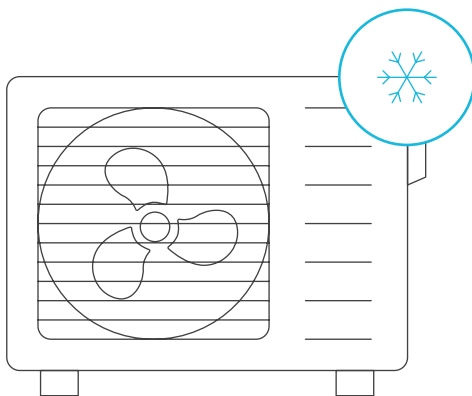

# CONTROLLER 69 PRO

## PROGRAMMING

### AUTO MODE (LOW TEMPERATURE TRIGGER)

Pressing the up or down button sets the low temperature trigger. The devices will activate if the probe's reading meets or falls below this threshold.

Once triggered, the devices will gradually ramp up to the level set in ON mode. If the probe's reading rises above this trigger point, the devices will gradually slow down to a stop or at the level set in OFF mode.

You may set this trigger above the high temperature trigger to create a specific range in which the devices are active.

This is typically used with devices like heaters and seedling mats to help raise the temperature when it gets too cold. For example, if you set a low temperature trigger of 78°F, then your device will activate when the temperature falls to 78°F or lower, and turn off when it rises above 78°F. Products shown here may still be in development.

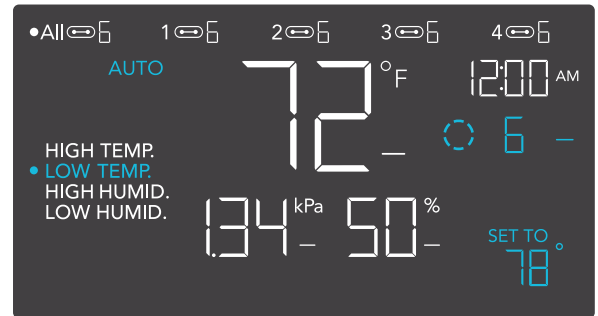

Any of the four trigger points can activate while you are in AUTO Mode, even if you are viewing another trigger point. Please set a trigger point to OFF if not in use, by holding down the up and down button. If there is a level set in OFF Mode other than zero, the devices will run at that level when triggered to turn off.

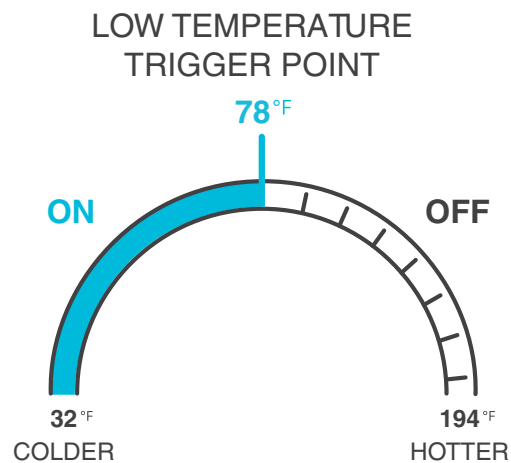
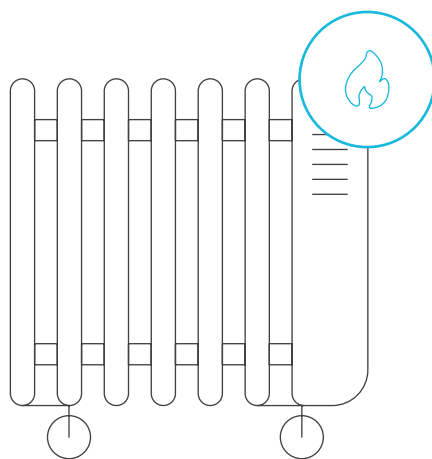

# CONTROLLER 69 PRO

## PROGRAMMING

### AUTO MODE (HIGH HUMIDITY TRIGGER)

Pressing the up or down button sets the high humidity trigger. The devices will activate if the probe's reading meets or exceeds this threshold.

Once triggered, the devices will gradually ramp up to the level set in ON mode. If the probe's reading falls below this trigger point, the devices will gradually slow down to a stop or at the level set in OFF mode.

You may set this trigger below the low humidity trigger to create a specific range in which the devices are active.

This is typically used with devices like dehumidifiers to help lower the humidity when it gets too humid. For example, if you set a high humidity trigger of 48%, then your device will activate when the humidity rises to 48% or higher, and turn off when it falls below 48%. Products shown here may still be in development.

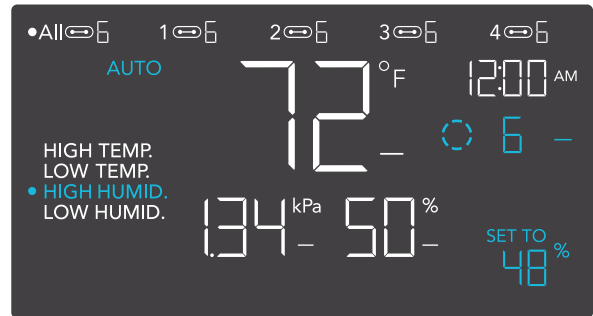

Any of the four trigger points can activate while you are in AUTO Mode, even if you are viewing another trigger point. Please set a trigger point to OFF if not in use, by holding down the up and down button. If there is a level set in OFF Mode other than zero, the devices will run at that level when triggered to turn off.

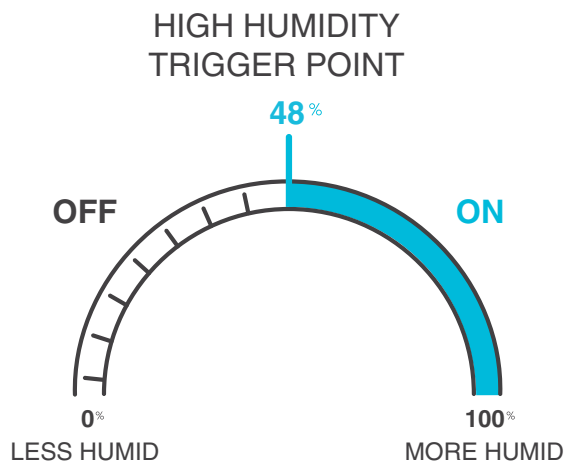
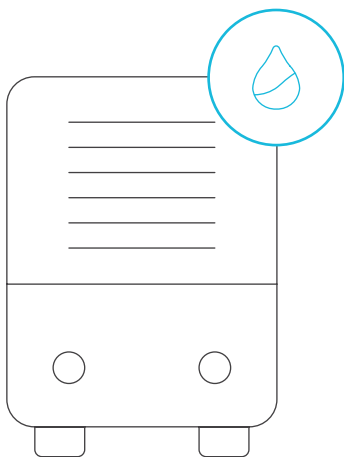

# CONTROLLER 69 PRO

## PROGRAMMING

### AUTO MODE (LOW HUMIDITY TRIGGER)

Pressing the up or down button sets the low humidity trigger. The devices will activate if the probe's reading meets or falls below this threshold.

Once triggered, the devices will gradually ramp up to the level set in ON mode. If the probe's reading rises above this trigger point, the devices will gradually slow down to a stop or at the level set in OFF Mode.

You may set this trigger above the high humidity trigger to create a range in which the devices are active.

This is typically used with devices like humidifiers to help raise the humidity when it gets too dry. For example, if you set a low humidity trigger of 57%, then your device will activate when the humidity falls to 57% or lower, and turn off when it rises above 57%. Products shown here may still be in development.

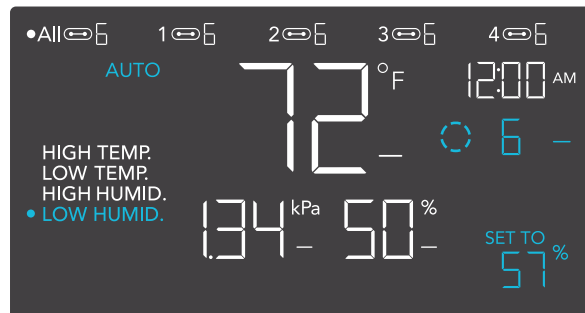

Any of the four trigger points can activate while you are in AUTO Mode, even if you are viewing another trigger point. Please set a trigger point to OFF if not in use, by holding down the up and down button. If there is a level set in OFF Mode other than zero, the devices will run at that level when triggered to turn off.

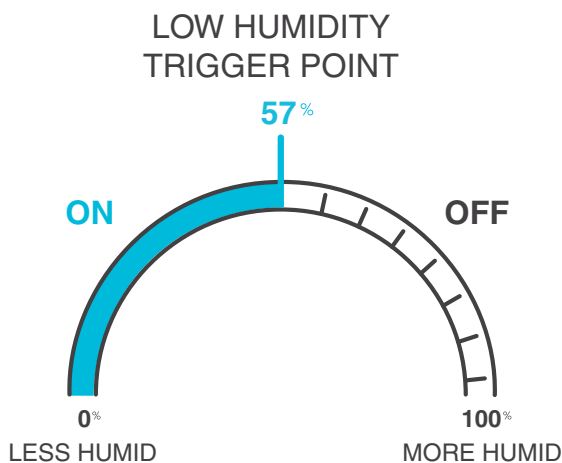
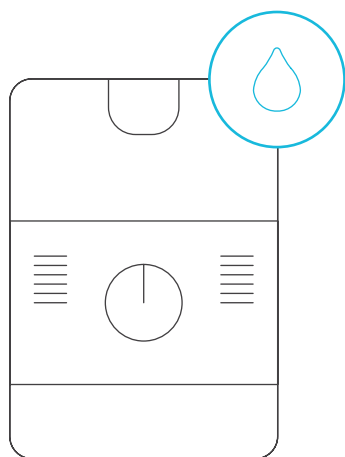

# CONTROLLER 69 PRO

## PROGRAMMING

### VPD MODE (HIGH VPD TRIGGER)

Pressing the up or down button sets the high VPD trigger. The devices will activate if the probe's reading meets or exceeds this threshold.

Once triggered, the devices will gradually ramp up to the level set in ON mode. If the probe's reading falls below this trigger point, the devices will gradually slow down to a stop or at the level set in OFF mode.

You may set this trigger below the low VPD trigger to create a specific range in which the devices are active.

Either of the two trigger points can activate while you are in VPD Mode, even if you are viewing another trigger point. Set a trigger point to OFF if not in use, by holding down the up and down button. If there is a level set in OFF Mode other than zero the devices will run at that level when triggered to turn off.

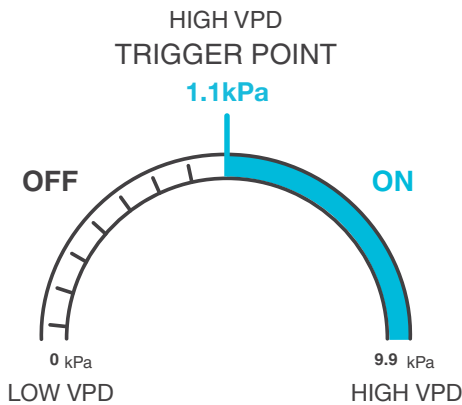



# CONTROLLER 69 PRO

## PROGRAMMING

### VPD MODE (LOW VPD TRIGGER)

Pressing the up or down button sets the low VPD trigger. The devices will activate if the probe's reading meets or falls below this threshold.

Once triggered, the devices will gradually ramp up to the level set in ON mode. If the probe's reading rises above this trigger point, the devices will gradually slow down to a stop or at the level set in OFF Mode.

You may set this trigger above the high VPD trigger to create a range in which the devices are active.

Either of the two trigger points can activate while you are in VPD Mode, even if you are viewing another trigger point. Set a trigger point to OFF if not in use, by holding down the up and down button. If there is a level set in OFF Mode other than zero the devices will run at that level when triggered to turn off.

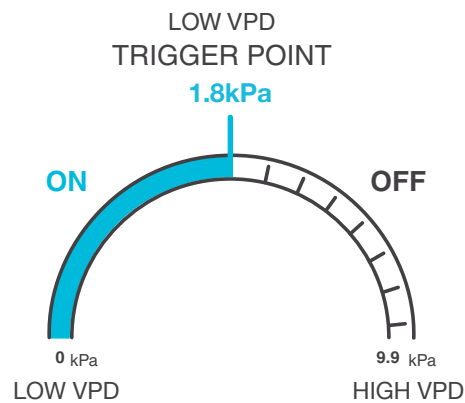

# CONTROLLER 69 PRO

## PROGRAMMING

### TIMER TO ON MODE

Pressing the up or down button sets a countdown time. During the countdown, your device will be set to OFF. Once the timer ends, your device will trigger to turn on. If there is a level set in OFF Mode, the devices will run at that level during the countdown and when triggered to turn off.

The countdown will begin if no buttons are pressed for 5 seconds. The time left on the countdown is shown on the lower right corner of the display above the setting. Leaving the timer mode while the countdown is running will pause it until you return to this mode.



TIMER TO ON  
(COUNTDOWN END POINT)

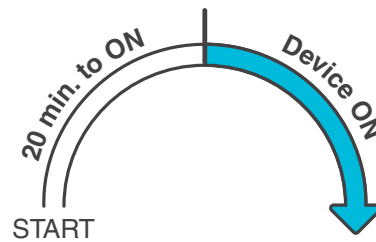

### TIMER TO OFF MODE

Pressing the up or down button sets a countdown time. During the countdown, your device will be set to ON. Once the timer ends, your device will trigger to turn off. If there is a level set in OFF Mode, the devices will run at that level after the end of the countdown.

The countdown will begin if no buttons are pressed for 5 seconds. The time left on the countdown is shown on the lower right corner of the display above the setting. Leaving the timer mode while the countdown is running will pause it until you return to this mode.

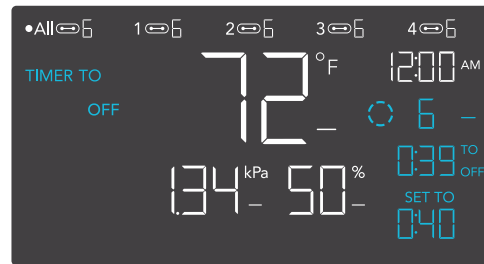

TIMER TO OFF  
(COUNTDOWN END POINT)

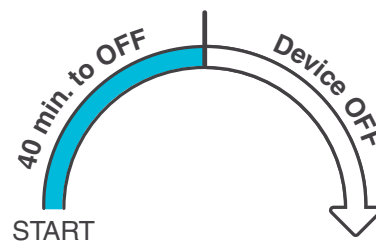

# CONTROLLER 69 PRO

## PROGRAMMING

### CYCLE MODE (ON AND OFF)

Set an on duration and an off duration for the devices to cycle through continuously. Press the up or down button to first set a duration for the devices to activate. Then press the mode button again and set a duration for the devices to deactivate.

When the devices are activated, they will run at the level set in ON Mode. When the devices are deactivated, they will run at the level set in OFF Mode.

The countdown will begin if no buttons are pressed for 5 seconds. The time left on the countdown before the next ON or OFF phase is displayed below the current level. Leaving the cycle mode while the countdown is running will pause it until you return to this mode.

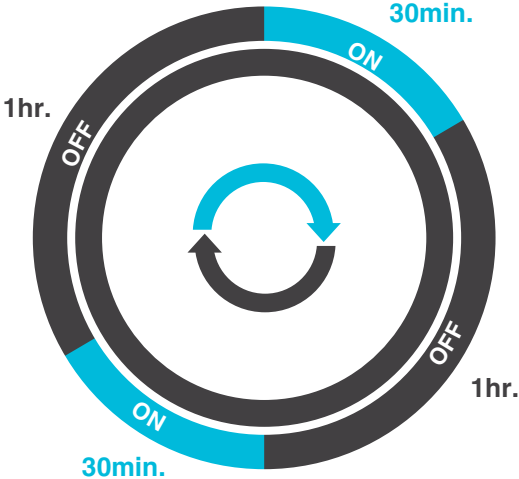

If there is a level set in OFF Mode other than zero, the devices will run at that level when triggered to turn off.

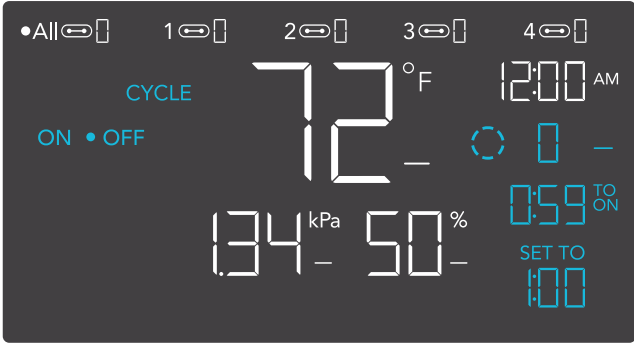
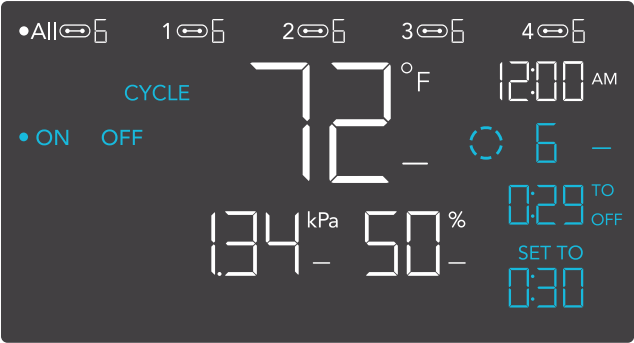

# CONTROLLER 69 PRO

## PROGRAMMING

### SCHEDULE MODE (ON AND OFF)

Sets an on clock-time and an off clock-time schedule for the devices to follow daily.

Press the up or down button to first set up an on clock-time to trigger ON mode, then press the mode button to set an off clock-time to trigger OFF mode. Please be sure to set the current clock time under settings.

When the devices are triggered to activate, they will run at the level set in ON Mode. When the devices are triggered to deactivate, they will run at the level set in OFF Mode.

The countdown will begin if no buttons are pressed for 5 seconds. The time left on the countdown before the next on or off phase is displayed below the current level. The devices will not follow this schedule if you leave this mode. If you re-enter the Schedule Mode, they will continue to follow the latest schedule you have set.

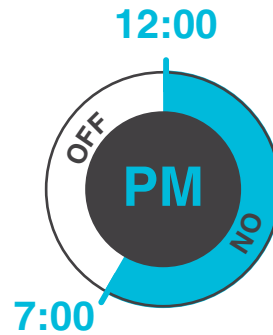
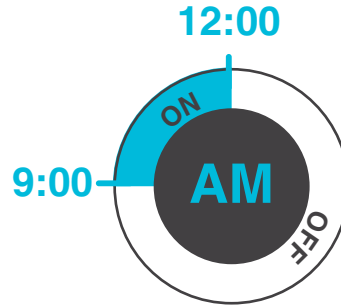

If there is a level set in OFF Mode other than zero, the devices will run at that level when triggered to turn off.



# CONTROLLER 69 PRO

## PROGRAMMING

### CONTROLLER SETTINGS

Pressing the setting button will cycle through the controller's available settings: DISPLAY, CLOCK, °F / °C, CALIB. T° / H% / kPa, TRANS. T° / H% / kPa, BUFF. T° / H% / kPa, and LEAF OFFSET.

### DISPLAY SETTING

Adjusts the display brightness and auto-dimming. Press the up or down button to cycle through levels 1, 2, 3, A2 and A3; 3 being the highest brightness setting, while 1 is the lowest. In settings 1, 2 and 3, the display will stay at that brightness level and will not automatically dim the display.

A2 and A3 will set the brightness level at 2 and 3, respectively, and will dim down the brightness to level 1 when the controller is not being used after 15 seconds.

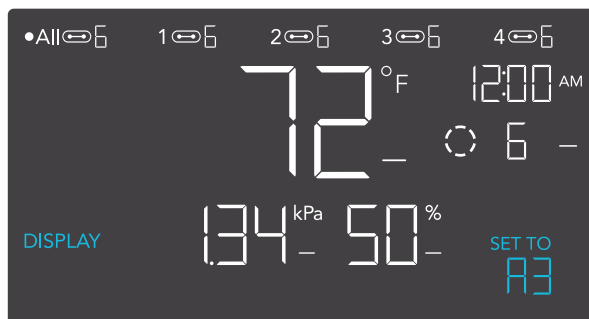

### TOGGLING THE DISPLAY

Lock the controller by holding the setting button.

Press the setting button to turn the display off. Pressing the setting button again will turn the display back on.

Programs will still run in the background while the LCD screen is off.

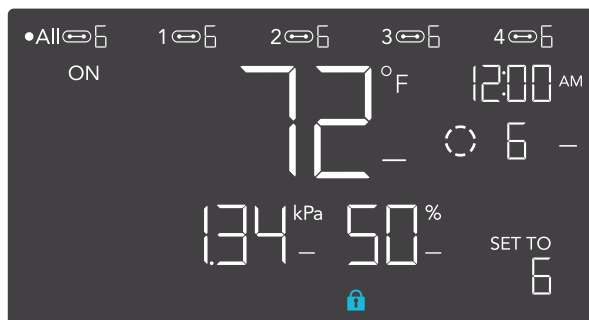

# CONTROLLER 69 PRO

## PROGRAMMING

### °F/°C SETTING

Changes the displayed units to Fahrenheit or Celsius. Press the up or down button to cycle through F and C. All displayed units will automatically convert when adjusting this setting.

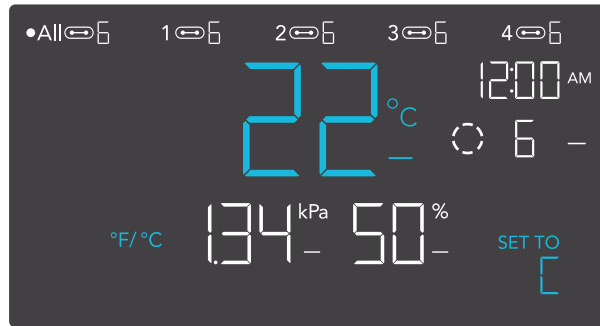

---

### CLOCK SETTING

Adjusts the current clock time. Press the up or down button to increase or decrease the time. Once you cycle through 12:00 each time, the units will automatically change to AM or PM. The clock time is located at the top right corner of the display.

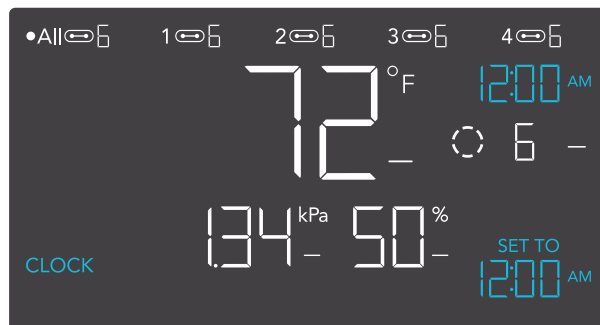

# CONTROLLER 69 PRO

## PROGRAMMING

### CALIBRATION TEMPERATURE SETTING

Adjusts the temperature reading the sensor probe is measuring. Press the up or down button to increase or decrease the data figure in 2°F (or 1°C) increments. The calibration cycle ranges from -20°F to 20°F (or -10°C to 10°C) and will be applied to the sensor probe's measurements.

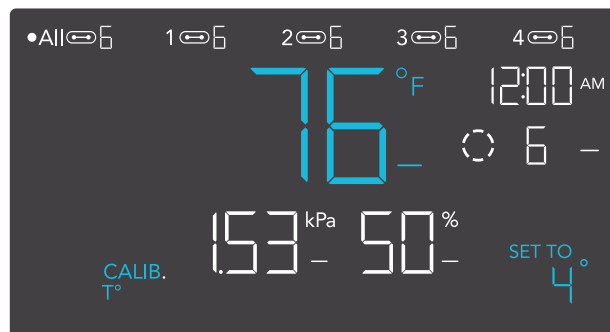

### CALIBRATION HUMIDITY SETTING

Adjusts the relative humidity reading the sensor probe is measuring. Press the up or down button to increase or decrease the data figure in 1% increments. The calibration cycle ranges from -10% to 10% and will be applied to the sensor probe's measurements.

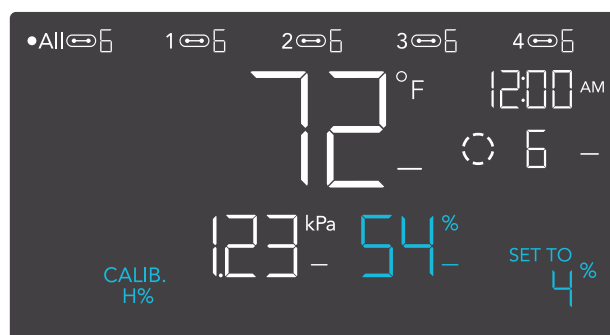

### CALIBRATION LEAF OFFSET SETTING

Adjusts the VPD reading the sensor probe is measuring. Press the up or down button to increase or decrease the data figure in 1° increments. The calibration cycle ranges from -20°F to 20°F (or -10°C to 10°C) and will be applied to the sensor probe's measurements.

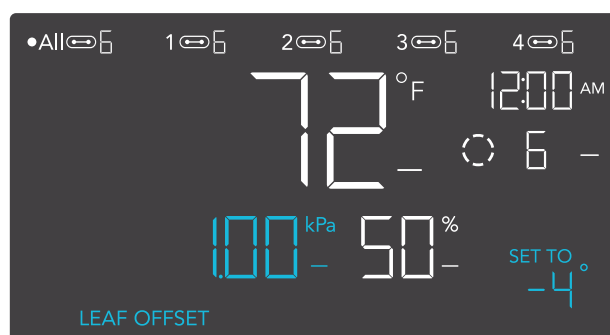

# CONTROLLER 69 PRO

## PROGRAMMING

### TRANSITION TEMPERATURE SETTING

Adjusts how gradually your device will shift between levels when triggered ON by the AUTO Mode's temperature trigger. This will determine how much the probe temperature needs to increase to step up to the next level setting.

The higher the transition setting is, the wider the temperature gap is between levels. The lower the transition setting is, the smaller the temperature gap is between levels. If this figure is set to zero, your device will jump to your maximum level when triggered ON.

Press the up or down button to set a transition threshold between 0°F and 20°F (0°C and 10°C). When the sensor temperature first reaches or crosses the temperature trigger point, the level will increase by one (exiting OFF Mode). Each time the threshold level is crossed, the level will ramp up by one until it reaches the level set in ON Mode.

### EXAMPLE

In this example, your high temperature trigger is set at 80°F, the OFF Mode level is 0, and the ON Mode level is 6. If the transition threshold is set to 0°F, then once the sensor temperature reaches or exceeds 80°F, the devices will trigger to run at level 6. However, if the transition threshold is set to 2°F, then the devices will trigger to run at level 1 when the temperature reaches or exceeds 80°F. It will then ramp up to level 2 when the temperature reaches or exceeds 82°F, level 3 at 84°F, etc. From 90°F on, it will run at level 6, the level set in ON Mode.

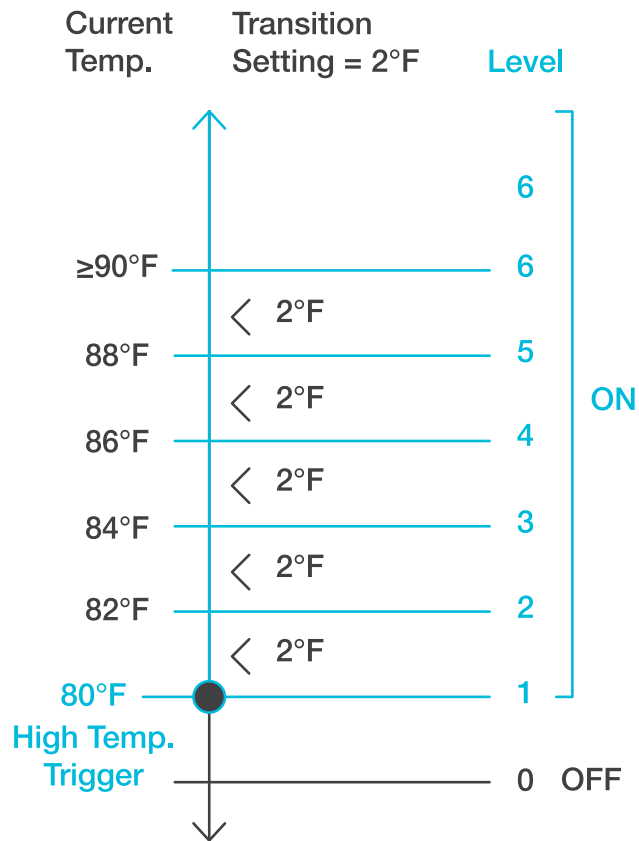
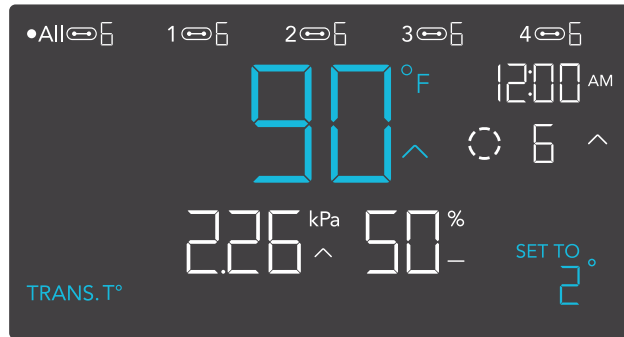



# CONTROLLER 69 PRO

## PROGRAMMING

### TRANSITION HUMIDITY SETTING

Adjusts how gradually your device will shift between levels when triggered ON by the AUTO Mode's humidity trigger. This will determine how much the probe humidity needs to increase to step up to the next level setting.

The higher the transition setting is, the wider the humidity gap is between levels. The lower the transition setting is, the smaller the humidity gap is between levels. If this figure is set to zero, your device will jump to your maximum level when triggered ON.

Press the up or down button to set a transition threshold between 0% and 10%. When the sensor humidity first reaches or crosses the humidity trigger point, the level will increase by one (exiting OFF Mode). Each time the threshold level is crossed, the level will ramp up by one until it reaches the level set in ON Mode.

### EXAMPLE

In this example, your high humidity trigger is set at 70%, the OFF Mode level is 0, and the ON Mode level is 6. If the transition threshold is set to 0%, once the sensor humidity reaches or exceeds 70% then the devices will trigger to run at level 7. However, if the transition threshold is set to 2%, then the devices will trigger to run at level 1 when it reaches or exceeds 70%. It will then step up to level 2 when reaching or exceeding 72%, level 3 at 74%, etc. From 80% on, it will run at level 6, the level set in ON Mode.

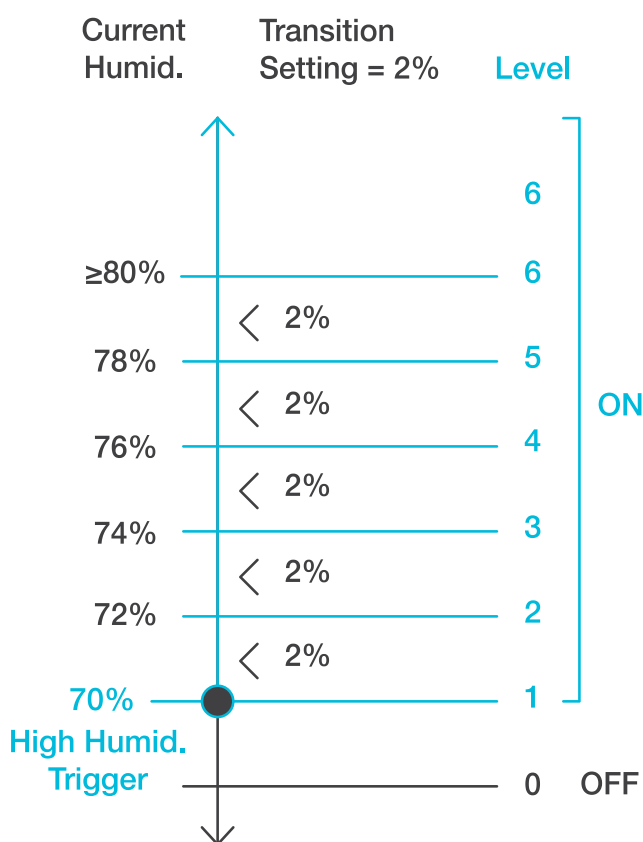
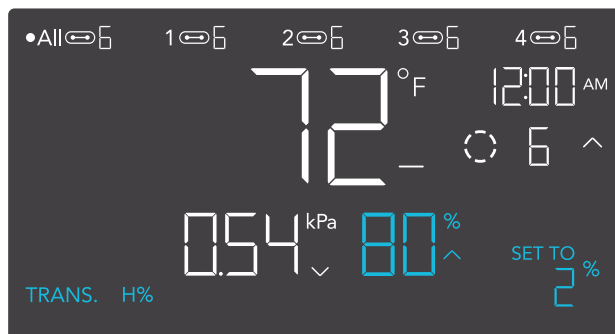

# CONTROLLER 69 PRO

## PROGRAMMING

### TRANSITION VPD SETTING

Adjusts how gradually your device will shift between levels when triggered ON by the VPD trigger. This will determine how much the probe VPD needs to increase to step up to the next level setting.

The higher the transition setting is, the wider the VPD gap is between levels. The lower the transition setting is, the smaller the VPD gap is between levels. If this figure is set to zero, your device will jump to your maximum level when triggered ON.

Press the up or down button to set a transition threshold between 0.1 kPa and 1.0 kPa. When the sensor VPD first reaches or crosses the VPD trigger point, the level will increase by one (exiting OFF Mode). Each time the threshold level is crossed, the level will ramp up by one until it reaches the level set in ON Mode.

### EXAMPLE

In this example, your high VPD trigger is set at 0.1 kPa, the OFF Mode level is 0, and the ON Mode level is 6. If the transition threshold is set to 0 kPa, then once the sensor temperature reaches or exceeds 0.1 kPa, the devices will trigger to run at level 6. However, if the transition threshold is set to 0.2 kPa, then the devices will trigger to run at level 1 when the VPD reaches or exceeds 0.1 kPa. It will then ramp up to level 2 when the VPD reaches or crosses 0.3 kPa, level 3 at 0.5 kPa, etc. From 1.1 kPa on, it will run at level 6, the level set in ON Mode.

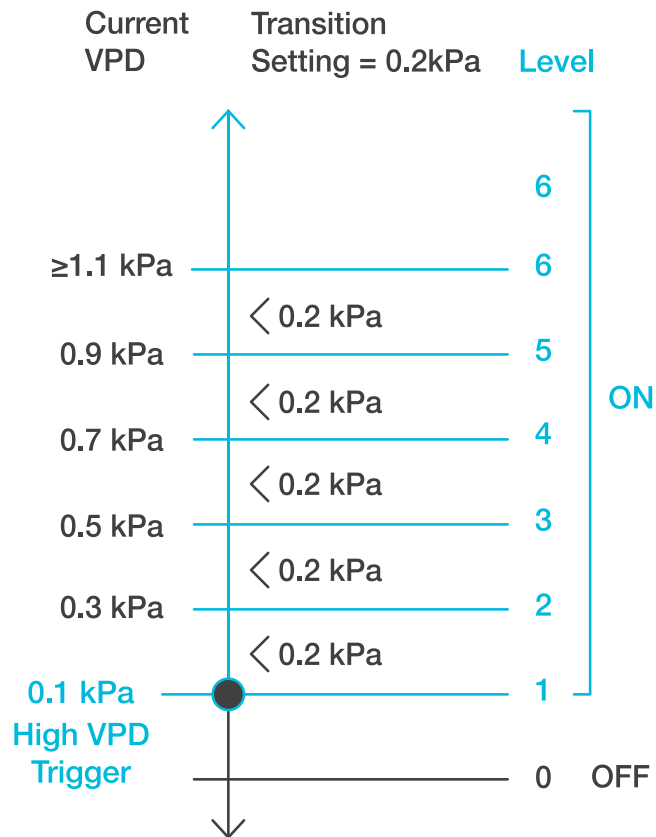
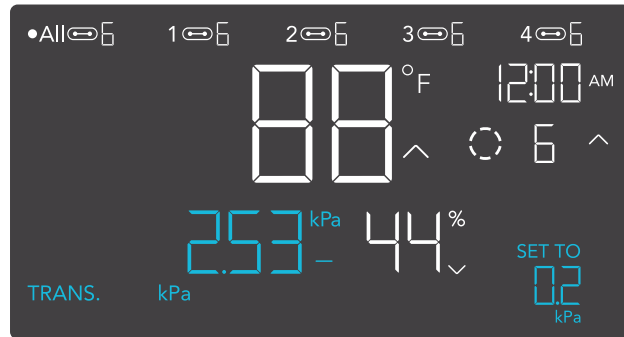

# CONTROLLER 69 PRO

## PROGRAMMING

### BUFFER TEMPERATURE SETTING

The buffer figure will create a trigger-off point below your set trigger point to prevent your device from shutting off too quickly. Press the up or down button to cycle through buffer range from 0°F to 8°F (or 0°C to 4°C).

In high temperature triggers, your device will turn on, only turning off when the temperature falls below your buffer setting.

In low temperature triggers, your device will turn on, only turning off when the temperature rises above your set buffer setting.

### EXAMPLE

For example, if you had set a High Temperature Trigger at 89°F and set a Temperature Buffer at 6°F. Then your device will trigger on when it meets or rises above 89°F, and only trigger off when it falls below 83°F. The 83°F figure is obtained by taking your High Temperature Trigger of 89°F and subtracting your Temperature Buffer of 6°F.

This setting will only appear in ports connected with outlet adapters.

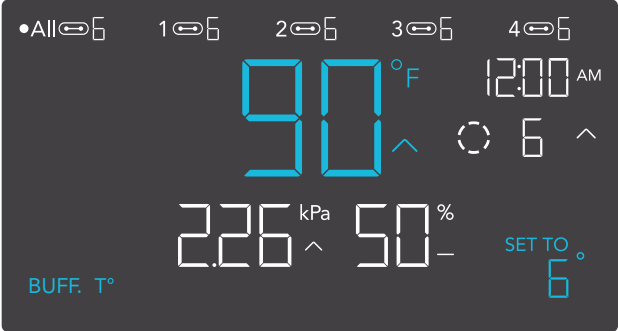
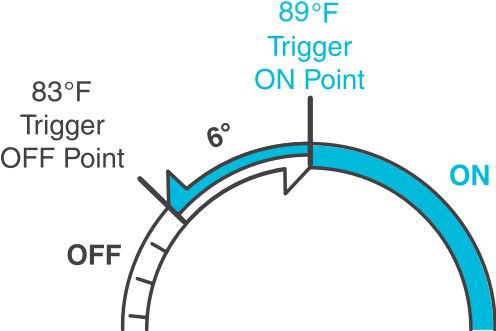

# CONTROLLER 69 PRO

## PROGRAMMING

### BUFFER HUMIDITY SETTING

The buffer figure will create a trigger-off point below your set trigger point to prevent your device from shutting off too quickly. Press the up or down button to cycle through buffer range from 0% to 10%.

In high humidity triggers, your device will turn on, only turning off when the humidity falls below your buffer setting.

In low humidity triggers, your device will turn on, only turning off when the humidity rises above your set buffer setting.

### EXAMPLE

For example, if you had set a High Humidity Trigger at 49% and set a Humidity Buffer at 4%. Then your device will trigger on when it meets or rises above 49%, and only trigger off when it falls below 45%. The 45% figure is obtained by taking your High Humidity Trigger of 49% and subtracting your Humidity Buffer of 4%.

This setting will only appear in ports connected with outlet adapters.

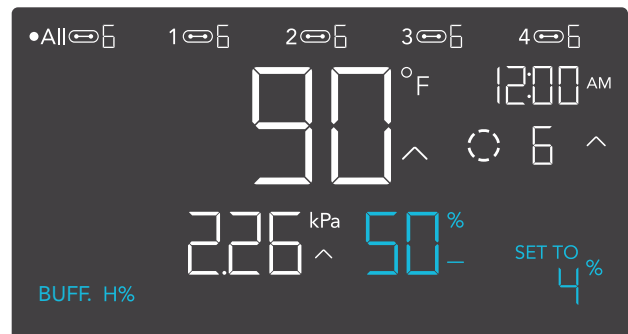
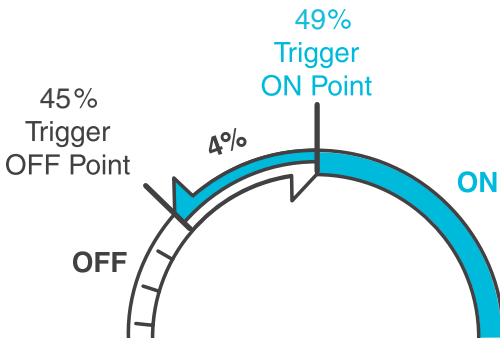

# CONTROLLER 69 PRO

## PROGRAMMING

### BUFFER VPD SETTING

The buffer figure will create a trigger-off point below your set trigger point to prevent your device from shutting off too quickly. Press the up or down button to cycle through buffer range from 0.1 kPa and 1.0 kPa.

In high VPD triggers, your device will turn on, only turning off when the VPD falls below your buffer setting.

In low VPD triggers, your device will turn on, only turning off when the VPD rises above your set buffer setting.

### EXAMPLE

For example, if you had set a High VPD Trigger at 2.51 kPa and set a VPD Buffer at 0.2 kPa. Then your device will trigger on when it meets or rises above 2.51 kPa, and only trigger off when it falls below 2.31 kPa. The 2.51 kPa figure is obtained by taking your High VPD Trigger of 2.51% and subtracting your VPD Buffer of 0.2 kPa.

This setting will only appear in ports connected with outlet adapters.

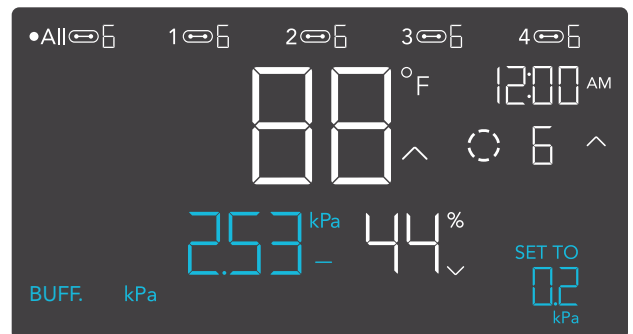
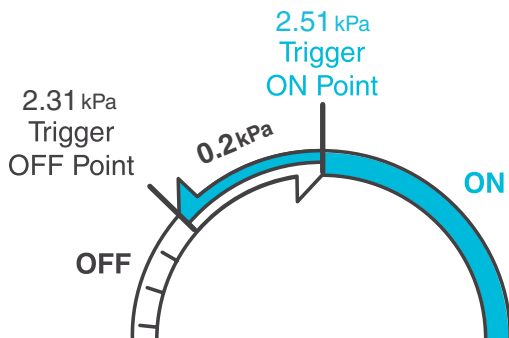

# CONTROLLER 69 PRO

## PROGRAMMING

### ALERT ICONS

The alert icons are displayed at the top of the screen. Icons may flash when the controller signals an alert to notify you of any triggered function or alarm.

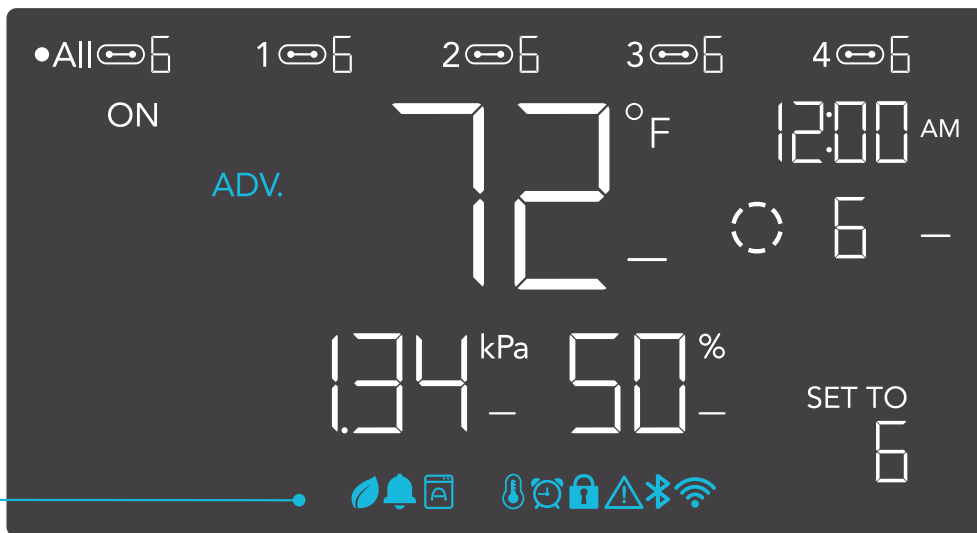

#### ADVANCE PROGRAMMING

Displays when an advance program set in the app is active. "ADV." will appear and override the controller if an automation program is in use.



#### AUTO MODE ALERT

Flashes whenever any of the auto mode triggers (high temperature, low temperature, high humidity, or low humidity) activate your devices.



#### TIMER ALERT

Flashes when a countdown has completed for TIMER TO ON, TIMER TO OFF, CYCLE, or SCHEDULE Mode.



#### VPD ALERT

Flashes whenever either VPD mode triggers (high VPD or low VPD) activate your devices.

# CONTROLLER 69 PRO

## PROGRAMMING



### WI-FI

Appears when the physical controller is connected to the app via Wi-Fi.



### DISPLAY LOCK ALERT

Displays when you lock the controller. The icon will flash and beep if you attempt to adjust the controller while it is still locked.



### ALERT

Flashes and beeps with an alert whenever a plugged-in device experiences interference to its functioning. Check your devices for possible issues.



### ALARM

Flashes and beeps with an alert if the temperature/humidity/VPD meet the trigger point set in the app.

# CONTROLLER 69 PRO

## OTHER SETTINGS

### FACTORY RESET

Holding the mode, up, and down buttons together for 5 seconds will reset your controller and restore factory settings. This clears all user parameters in each controller mode and setting.

HOLD +   

### CONTROLLER LOCK

Holding the setting button will lock the controller in your current mode. While your controller is locked, no parameters may be adjusted, nor will you be able to switch modes. Holding the setting button again will unlock the controller.

HOLD + 

### HIDE SCREEN

Lock the controller so no settings can be adjusted. See above. Then press the setting button to turn the display off. Pressing it again will turn the display back on. Programs will still run in the background while the LCD screen is off.

PRESS + 

### JUMP TO OFF MODE

Holding the mode button for 3 seconds while in any mode or setting will automatically jump to OFF Mode. This function is disabled if the controller is locked.

HOLD + 

### RESET TO OFF/DEFAULT

Holding the up and down buttons together for 2 seconds will reset the value of your current mode or controller setting to OFF/Default. Pressing either the up or down button will return to the previous value.

HOLD +  

### AUTO INCREASING OR DECREASING

Holding the up or down button will increase or decrease the user setting automatically until you release them.

HOLD + 

HOLD + 



# CONTROLLER 69 PRO

## DOWNLOAD THE APP

### THE AC INFINITY APP

The AC Infinity app enables you to connect with the next generation of our intelligent controllers, giving you access to advance programs and environmental data.

1

Download the AC Infinity app from the App Store or Play Store by searching “AC Infinity”.



2

Open the AC Infinity app and follow the instructions on page 114-120 to pair your controller with the app.

---

### QUICK TIP FOR EASY ACCESS

Open the smart phone camera and scan the QR code below to download the AC Infinity app. Please visit our website at [www.acinfinity.com](http://www.acinfinity.com) for more information on the AC Infinity app.



Please note: The AC Infinity App’s appearance and features are subject to change, and please refer to our website/QR for the latest instructions.

# CONTROLLER 69 PRO

## ADD A DEVICE: BLUETOOTH

### SETUP AND PAIRING

Power your device on before pairing your controller with the app. Logging in or creating an account beforehand will expedite the pairing process. Have your Wi-Fi network's name and password ready.

1

Tap on the “+” tab to add your smart device.

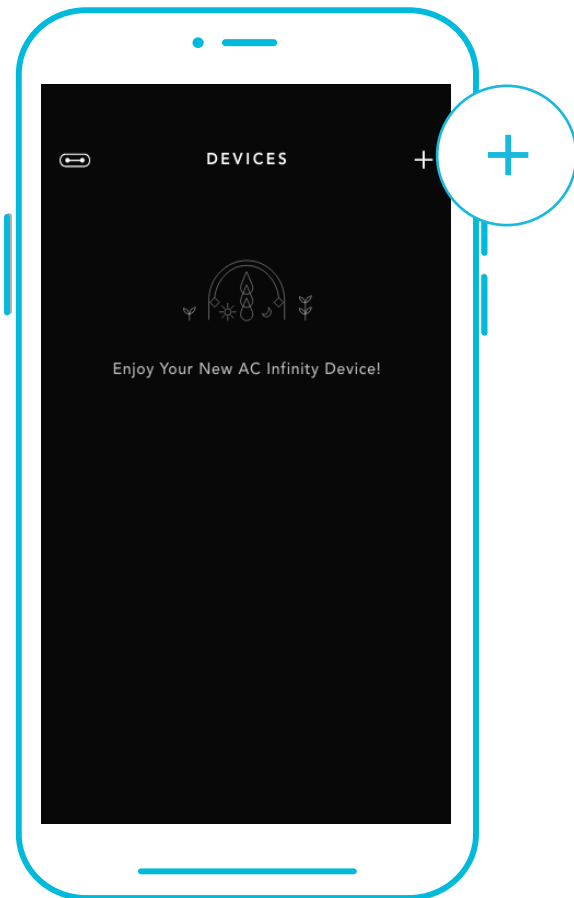

2

Tap on the “Smart Controllers” tab.

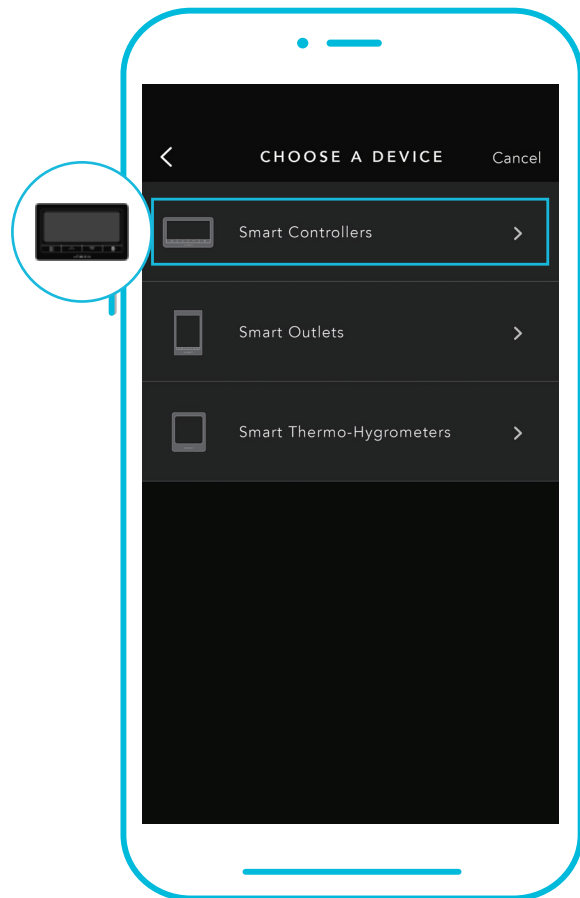

Please note: Bluetooth must be enabled on your mobile device before starting the pairing process.

# CONTROLLER 69 PRO

## ADD A DEVICE: BLUETOOTH

3

Select CONTROLLER 69 PRO.

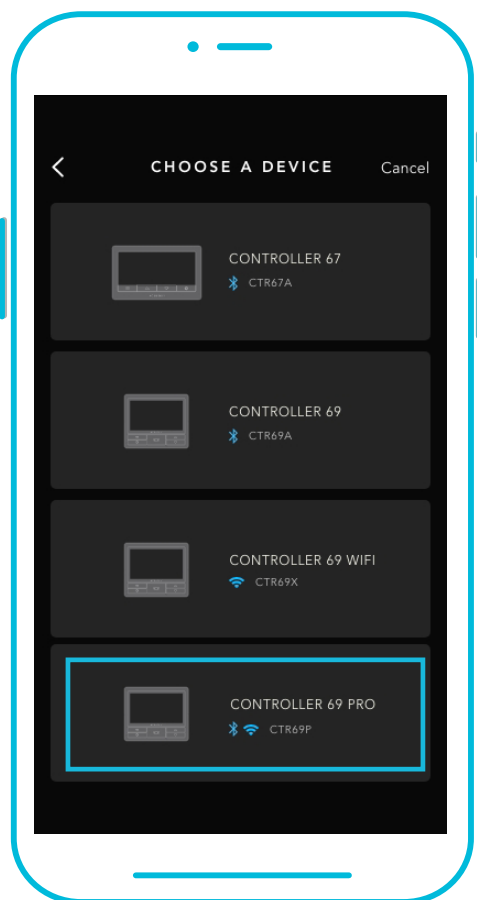

4

Hold the port button for 5 seconds to activate Bluetooth. Wait for the Bluetooth icon to start flashing on your controller's screen.

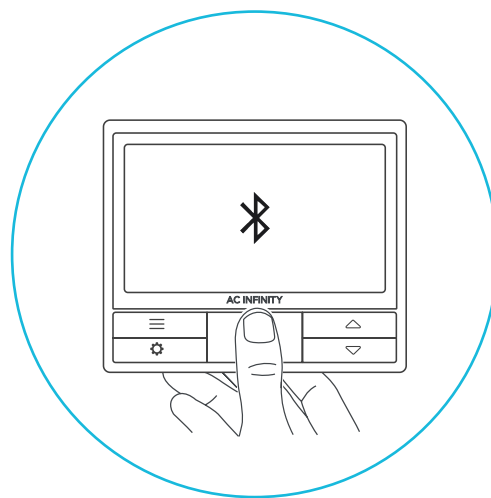

# CONTROLLER 69 PRO

## ADD A DEVICE: BLUETOOTH

5

Connect using Bluetooth. To connect using Wi-Fi, skip to step 8.

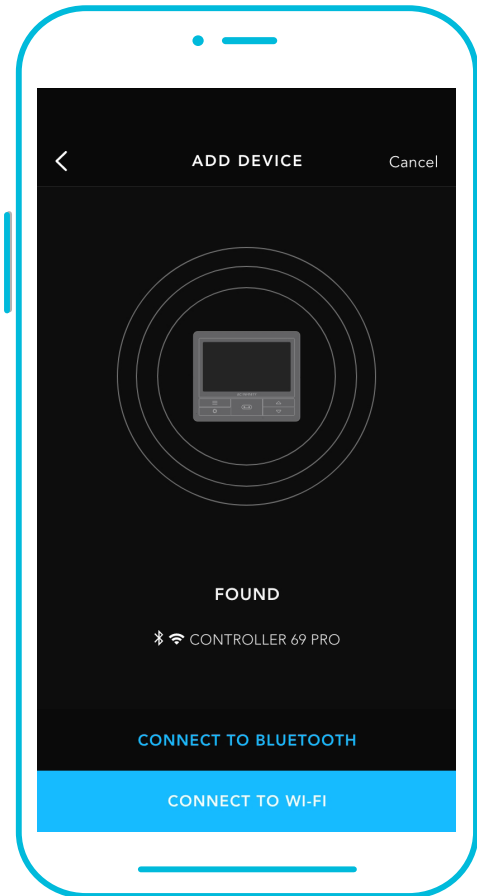

6

Connecting with Bluetooth will disable Wi-Fi functionality. Go to the app settings page to re-enable and connect using Wi-Fi.

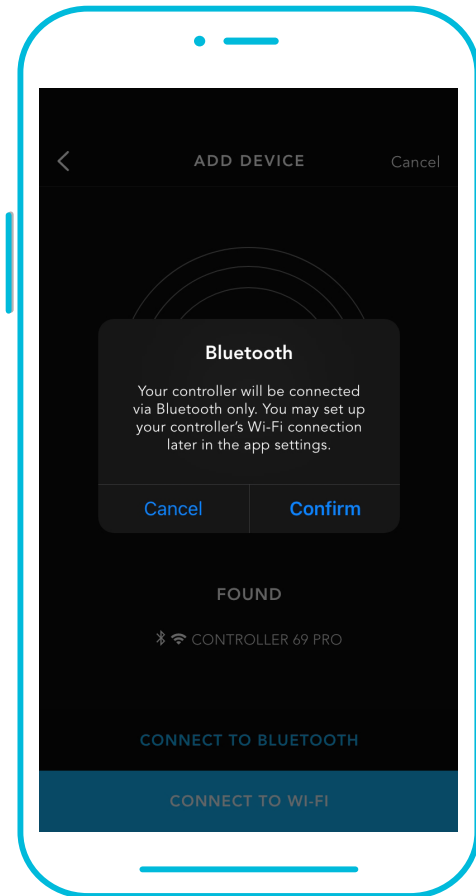

When pairing the app around multiple controllers, move your mobile device closer to your desired controller.

# CONTROLLER 69 PRO

## ADD A DEVICE: BLUETOOTH

7

Tap the DONE button to complete the pairing process.

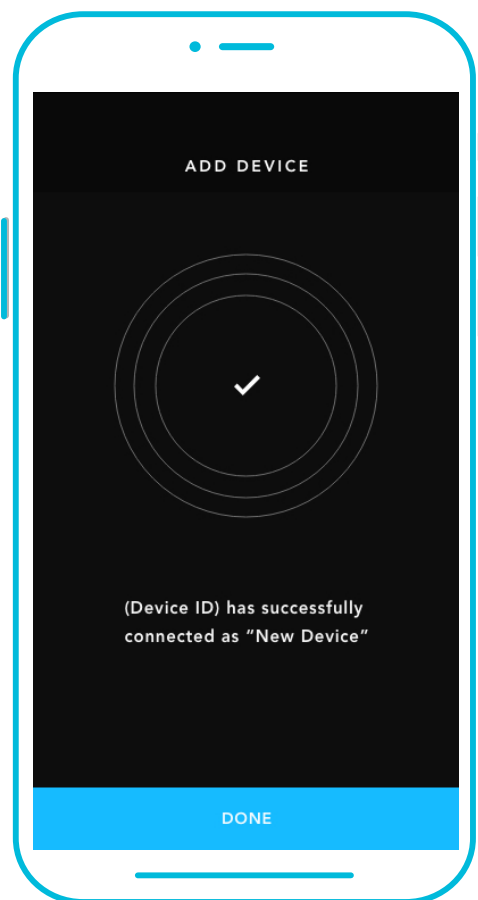

# CONTROLLER 69 PRO

## ADD A DEVICE: WI-FI

8

Repeat steps 1-5. Log in or create an account to continue.

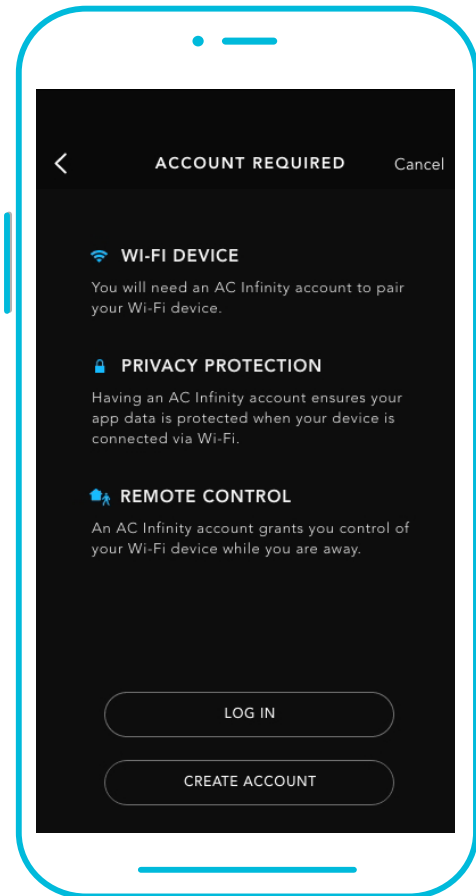

9

Enter your Wi-Fi network's password. You may also connect to an alternate 2.4 GHz router\*.

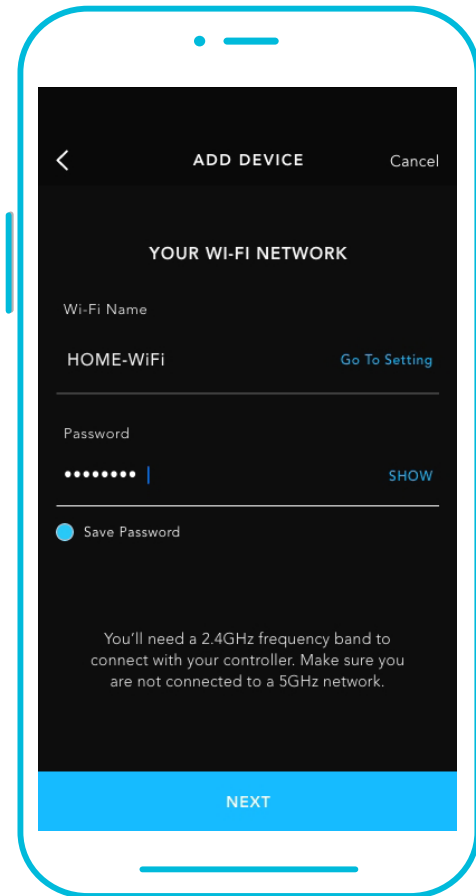

When pairing the app around multiple controllers, move your mobile device closer to your desired controller.

# CONTROLLER 69 PRO

## ADD A DEVICE: WI-FI

10

Follow these tips if the pairing process is unsuccessful.

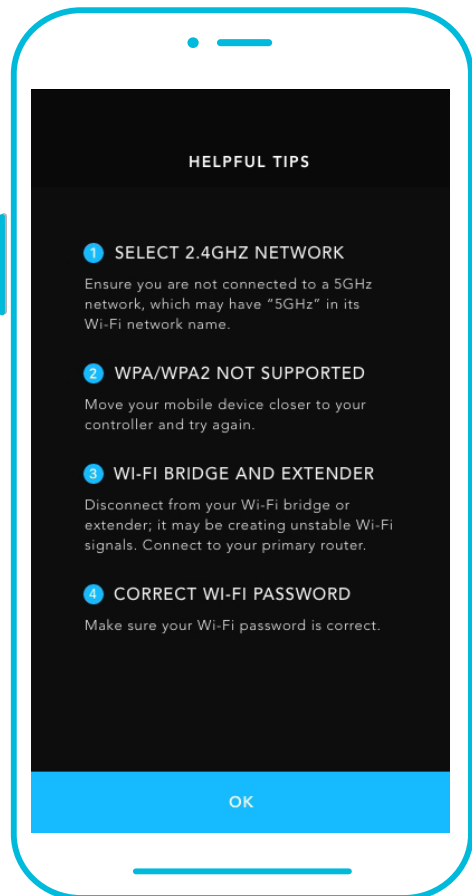

11

Tap the DONE button to complete the pairing process.

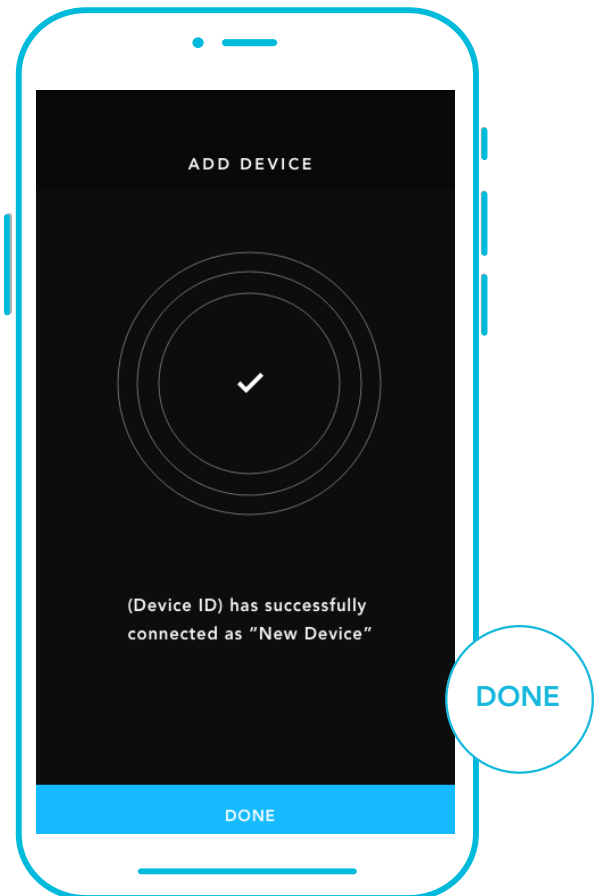

\*This controller is only compatible with 2.4 GHz frequency band routers. When connecting using Wi-Fi, make sure your mobile device is not connected to a 5 GHz frequency band network.

# CONTROLLER 69 PRO

## ADD A DEVICE: WI-FI

12

Your controller will appear in your smart device with a unique ID.

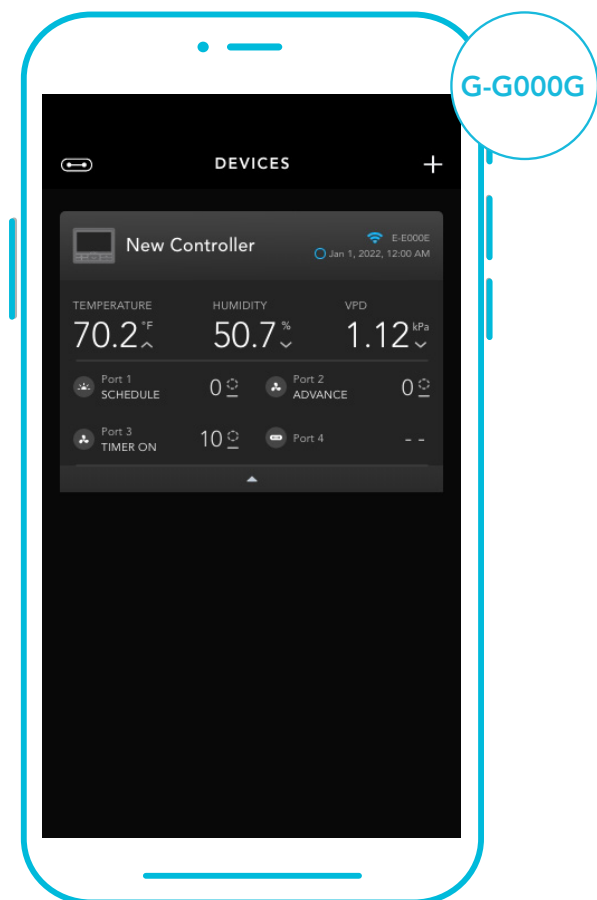



# CONTROLLER 69 PRO

## FREQUENTLY ASKED QUESTIONS

---

**Q: What devices are compatible with the CONTROLLER 69 PRO?**

**A:** All AC Infinity devices that contain a UIS connector are compatible. If your AC Infinity device has a 4-pin Molex connector and an EC-Motor, it may still be compatible with the use of an UIS adapter to convert its connector to fit with the controller.

---

**Q: What does “level” refer to in the controller and app?**

**A:** The level represents the intensity the device is running at. This is represented by a digit 0 to 10. Zero means the device is off, and 10 represents its running at its maximum. For fan devices, the level would be referring to its speed. For light devices, the level would be referring to its brightness. Note that on and off devices do not have a level setting.

---

**Q: Why is my device is not turning off when the programming is triggering it to be off?**

**A:** The figure set in OFF Mode determines the device’s level when it’s triggered to be OFF in all other modes. Set this figure to zero if you want the device to turn off when triggered OFF.

If this is occurring in AUTO Mode, check the points of your high and low triggers, which can all activate concurrently. Turn off any triggers that are not in use. If you are using the app, check to see if any ADVANCE programming is active, which can override any control programming.

---

**Q: Why does my device not run or run at a low level when the programming is triggering it to be on?**

**A:** The figure set in ON Mode determines the device’s level when it’s triggered to be ON in all other modes. Make sure this figure is not set to zero or the device will not run when triggered to be ON.

If this is occurring in AUTO Mode, check the points of your high and low triggers, which can all activate concurrently. Turn off any triggers that are not in use. If you are using the app, check to see if any ADVANCE programming is active, which can override any control programming.

---

**Q: Where is the best place to position the sensor probe?**

**A:** Place the sensor probe as close as possible to the hottest or most humid spot in your space.

---

**Q: Do I need to remove the plastic cap from the probe?**

**A:** Yes. You will need to remove the plastic cap so the probe can accurately read climate conditions.

# CONTROLLER 69 PRO

## FREQUENTLY ASKED QUESTIONS

---

**Q: How do I stop my device from turning on and off too quickly in AUTO MODE?**

**A:** The figure set in the TRANSITION under SETTINGS will determine how the device ramps up in levels when triggered to run in AUTO MODE. Set a transition threshold X. For every multiple of X that has surpassed your trigger point, the device will increase by one level. The lower the transition threshold is set to, the easier it will be for the device to ramp up in levels. If set to zero, the device will jump to the max set speed without ramping when triggered. This may cause the device to turn on and off quickly if the climate fluctuates back and forth. Increase the transition threshold number to help smooth out the transitions. Check the points of your high and low triggers, which can all activate concurrently. Turn off any triggers that are not in use.

---

**Q: How do I set a minimum speed for constant ventilation, that would ramp up when triggered?**

**A:** If a fan device is connected, the figure set in OFF MODE determines the fan speed when it's triggered to be OFF in all other modes. When the fan isn't triggered ON, it will be considered OFF and so it will run at that minimum speed continuously. Once triggered ON, it will change its speed to the figure set under ON MODE.

---

**Q: Can I connect different sized fans to the same controller?**

**A:** Please refer to pages 86-87 for details on adding more fan units.

---

**Q: Will I be able to use this controller with my own devices?**

**A:** The CONTROLLER 69 PRO is only compatible with AC Infinity fans that use EC-motors.

---

**Q: Does the controller retain its settings after power is shut off?**

**A:** Yes. If the controller's power is cut off and is powered on afterwards, your settings will remain.

---

**Q: My controller isn't pairing with the app. How do I fix this?**

**A:** If the pairing process isn't successful, turn off your Bluetooth and re-enable it to try again. When starting the pairing process around multiple Bluetooth controllers, move your smart device closer to the controller you wish to connect the app with.

# CONTROLLER 69 PRO

## FREQUENTLY ASKED QUESTIONS

**Q: Why does the app ask me for location permissions?**

**A:** The app requires location permissions to find the relative position of your smart controller and communicate with existing Bluetooth devices already paired with the app. All Android devices prior to system version 12.0 will require location permissions to be turned on for the Bluetooth scan to be successful.

---

**Q: Why do the port's level digits on the screen occasionally flash when I unplug a device?**

**A:** The controller may have received electronic interference during the disconnection. To fix this, completely cut off power from the controller by unplugging all connected devices. Then plug them back into their previous ports and resume normal use.

# WARRANTY

This warranty program is our commitment to you, the product sold by AC Infinity will be free from defects in manufacturing for a period of two years from the date of purchase. If a product is found to have a defect in material or workmanship, we will take the appropriate actions defined in this warranty to resolve any issues.

The warranty program applies to any order, purchase, receipt, or use of any products sold by AC Infinity or our authorized dealerships. The program covers products that have become defective, malfunctioned, or expressively if the product becomes unusable. The warranty program goes into effect on the date of purchase. The program will expire two years from the date of purchase. If your product becomes defective during that period, AC Infinity will replace your product with a new one or issue you a full refund.

The warranty program does not cover abuse or misuse. This includes physical damage, submersion of the product in water, incorrect installation such as wrong voltage input, and misuse for any reason other than intended purposes. AC Infinity is not responsible for consequential loss or incidental damages of any nature caused by the product. We will not warrant damage from normal wear such as scratches and dings.

Contact our dealers department at [dealers@acinfinity.com](mailto:dealers@acinfinity.com) or **(626) 838-4656** for more information about our dealers and distributors program. Contact our customer service department at [support@acinfinity.com](mailto:support@acinfinity.com) or **626-923-6399** for product and warranty assistance. Our business hours are Monday through Friday, 9:00 am to 5:00 pm PST.



**If you run into any issues with this product, contact us and we'll happily issue a replacement or a full refund!**

**COPYRIGHT © 2023 AC INFINITY INC. ALL RIGHTS RESERVED**

No part of the materials including graphics or logos available in this booklet may be copied, photocopied, reproduced, translated or reduced to any electronic medium or machine readable form, in whole or in part, without specific permission from AC Infinity Inc.





[www.acinfinity.com](http://www.acinfinity.com)