

Assembly Instructions

Caution: You must read this before you proceed

Alta Collection

THREE SEATER LOVESEAT

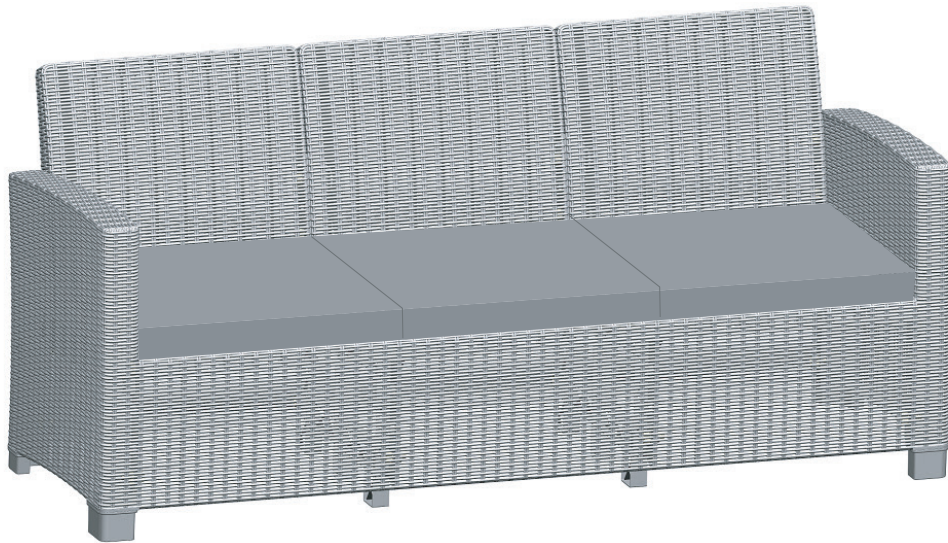

CAUTION

- This Three Seater Loveseat is NOT a TOY.
- Keep your child / children at bay in the process of assembly.
- For turning the Three Seater Loveseat and to prevent damage to the Three Seater Loveseat, 02 persons may be needed to execute this action.
- If you have any issues with your order, please contact us before returning **Mon-Fri 9am-5pm EST +1-844-554-6872 / info@dukapgear.com**



 SCAN ME

DUKAP OUTDOOR

www.dukapoutdoor.com

Parts List Loveseat

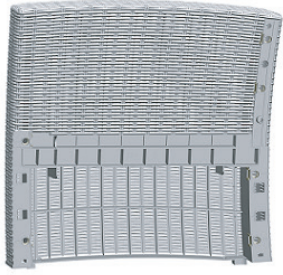

RS(X1)

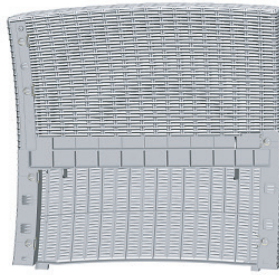

LS(X1)

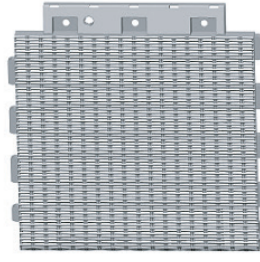

CS(X3)

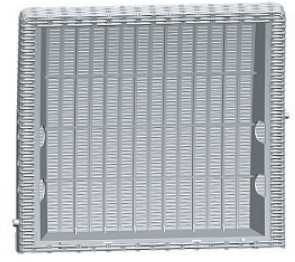

CB(X3)

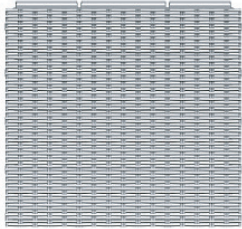

CBC(X3)

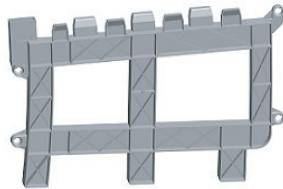

ML(X2)

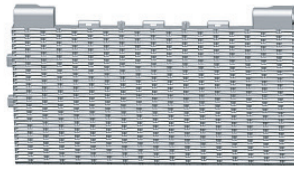

CF(X3)

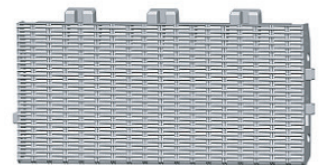

CR(X3)



LF(X1)

RF(X1)



BR(X1)

BL(X1)



ML1(X2)



(X33)



X1

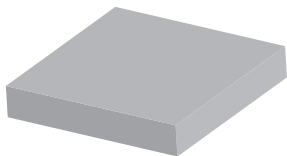
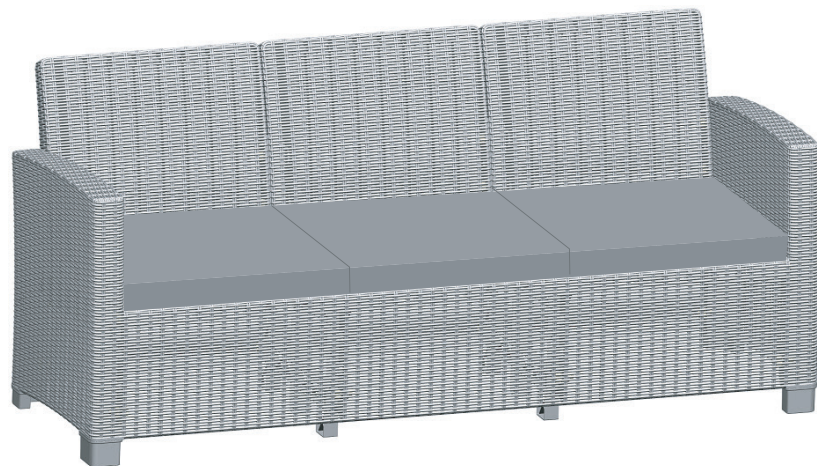

Seat Cushions (X3)



• Read instructions, cover to cover



• Have 2 adults on hand for assembly



• Do not assemble on flooring or carpet



• Assemble on a clean non-marring surface (packing foam)



• Save all packaging until finished

Step 1

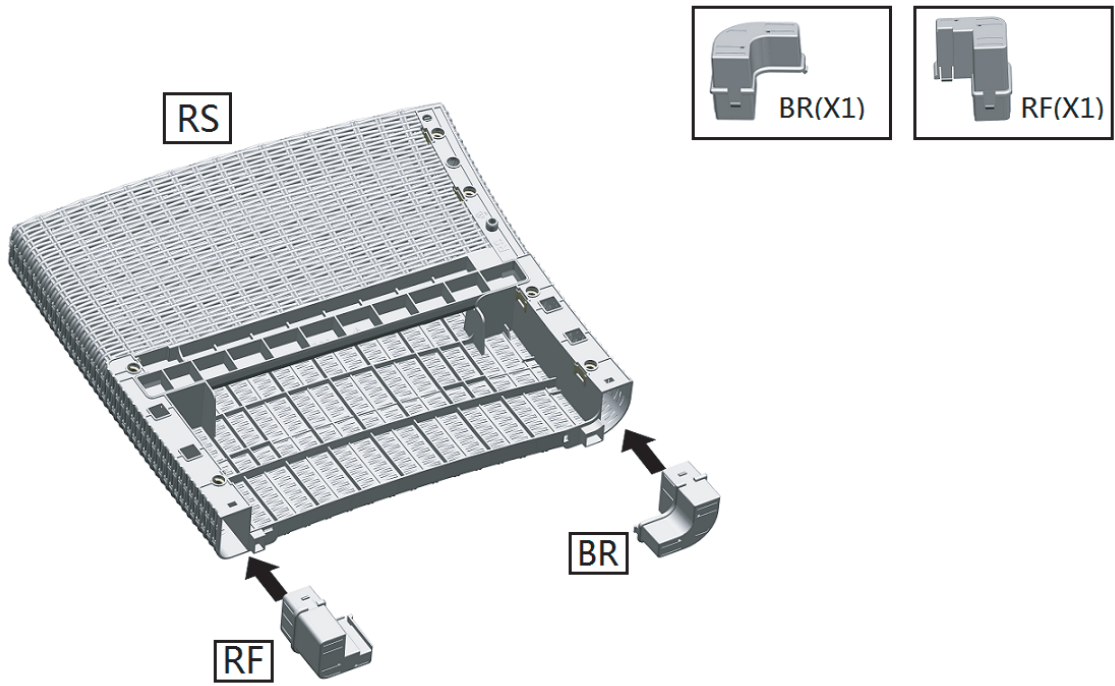

x1

Step 2

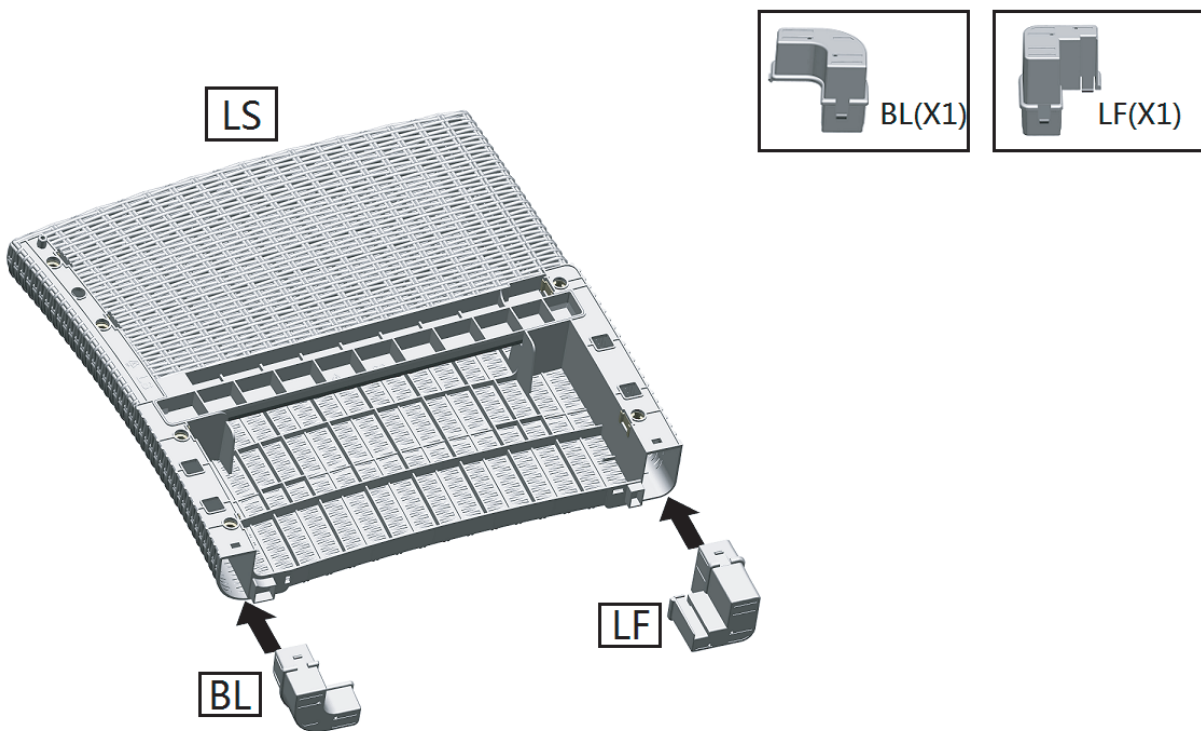

x1

Steps 3 & 4

Step 3

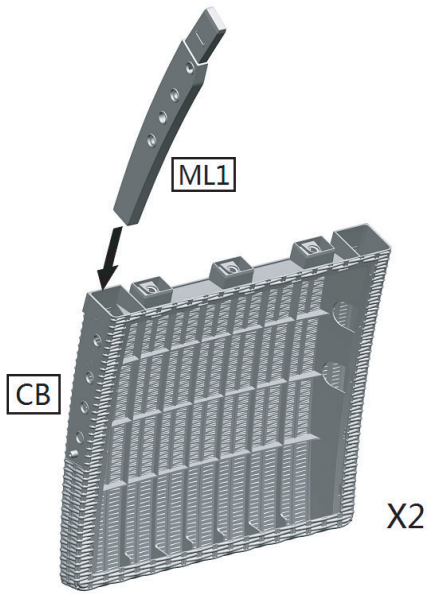

Step 4

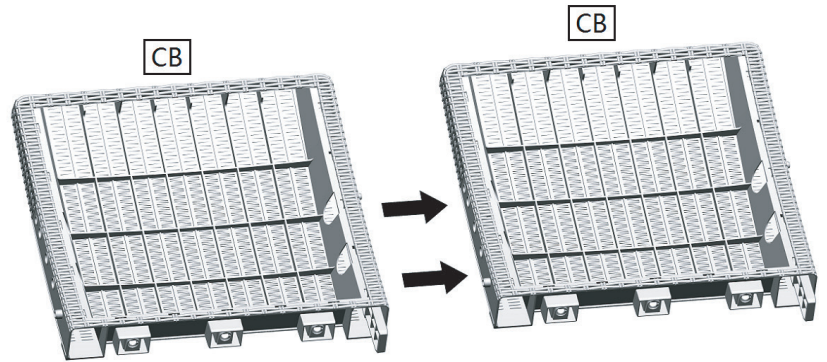

x1

Step 5

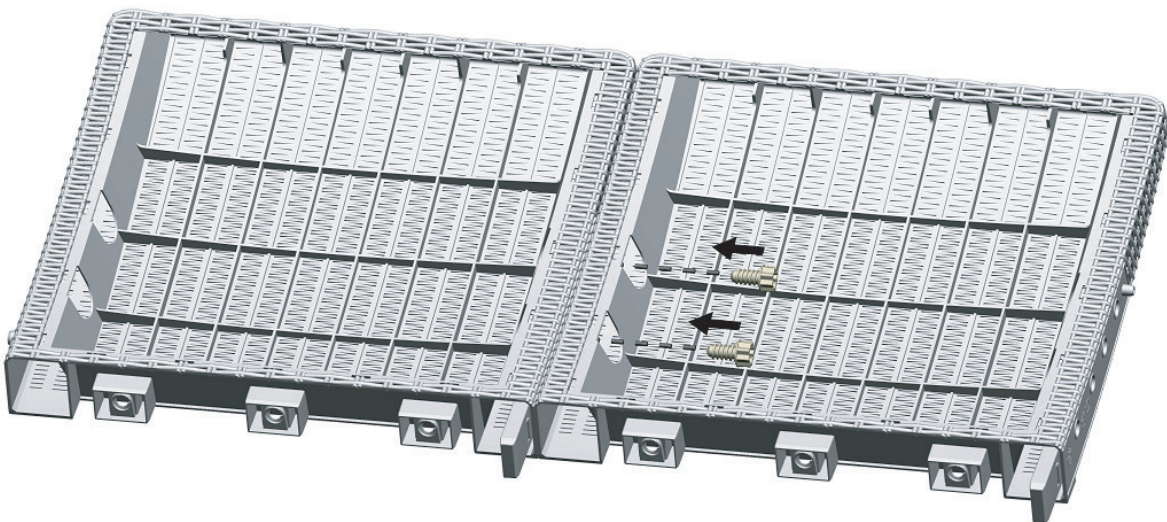

x1

Step 6

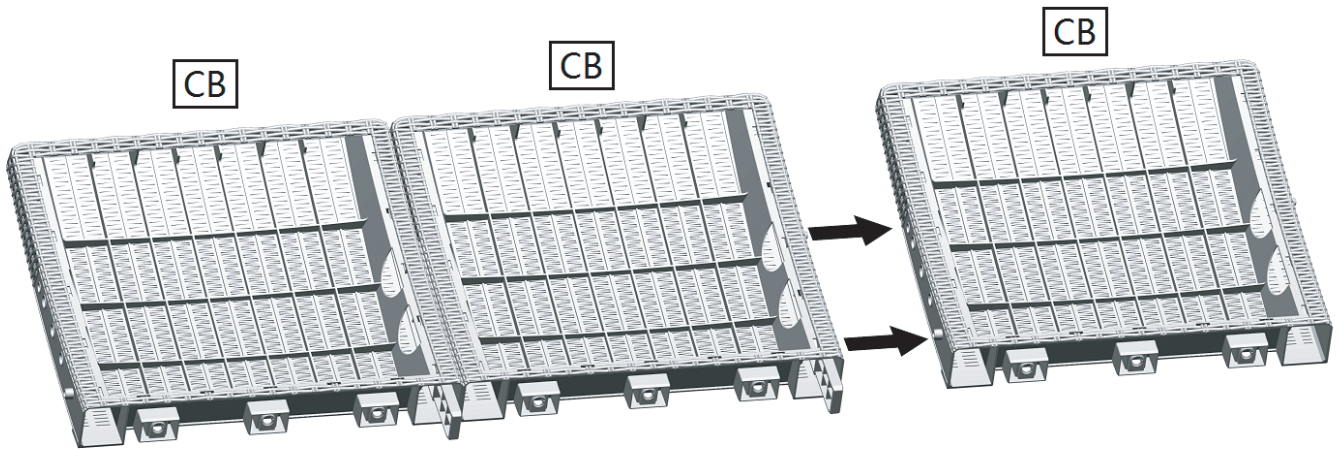

x1

Step 7

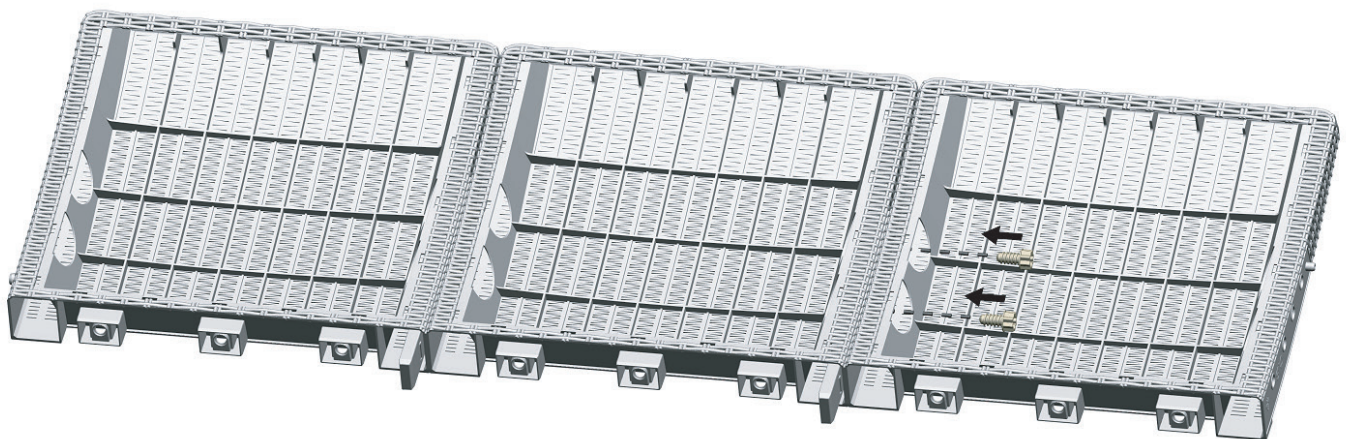

x1

Steps 8 & 9

Step 8

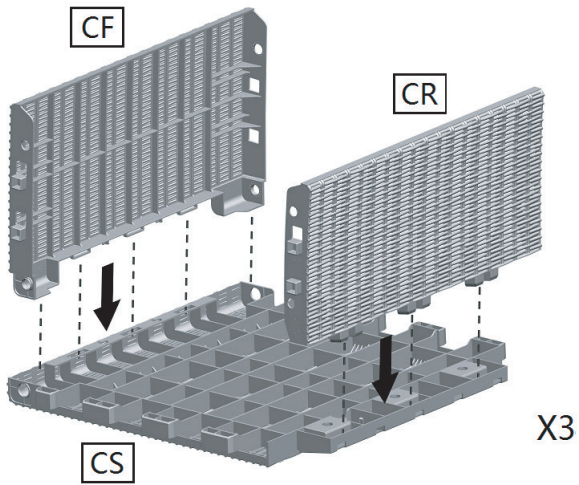

Step 9

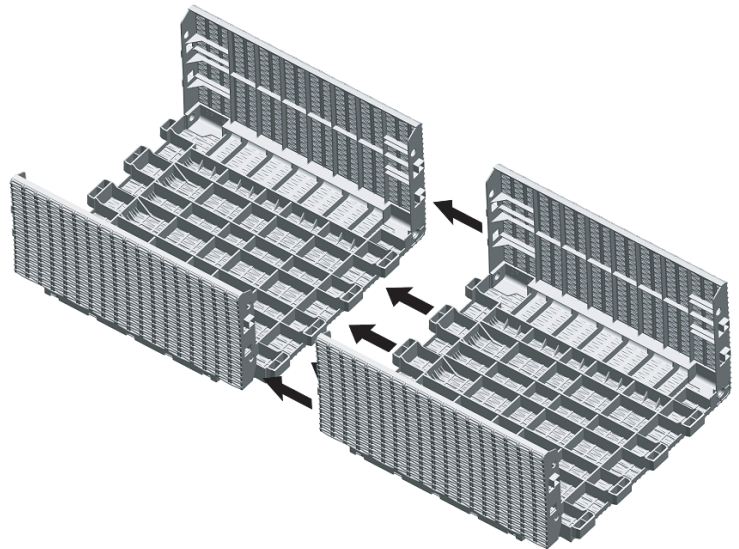

x1

Step 10

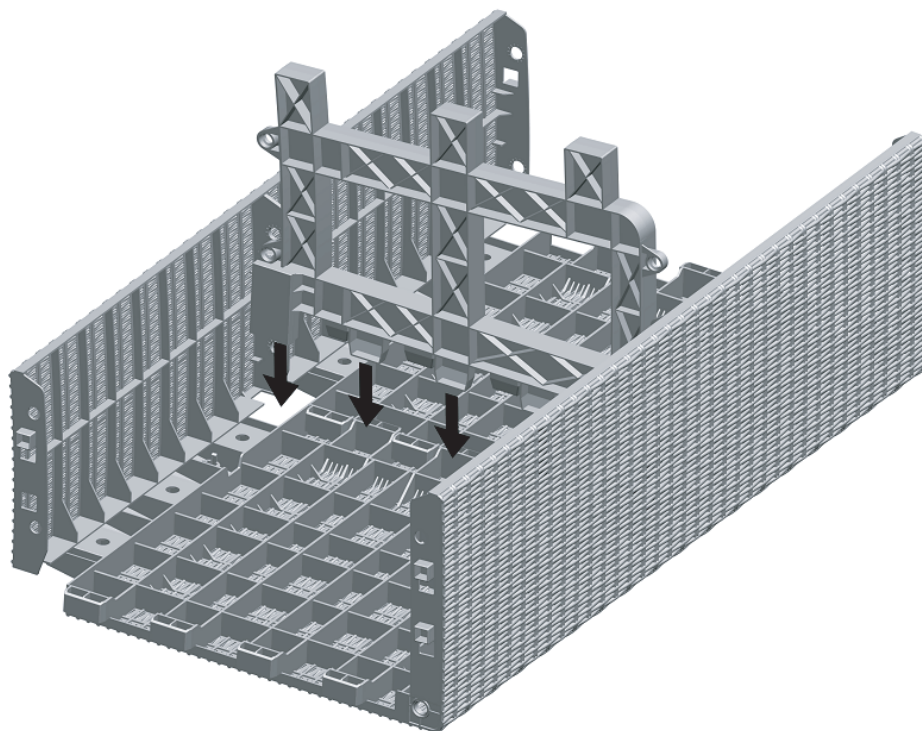

x1

Step 11

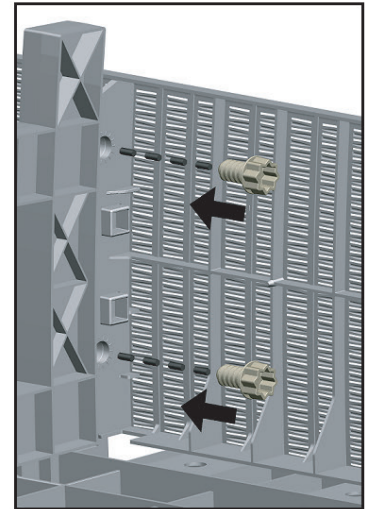
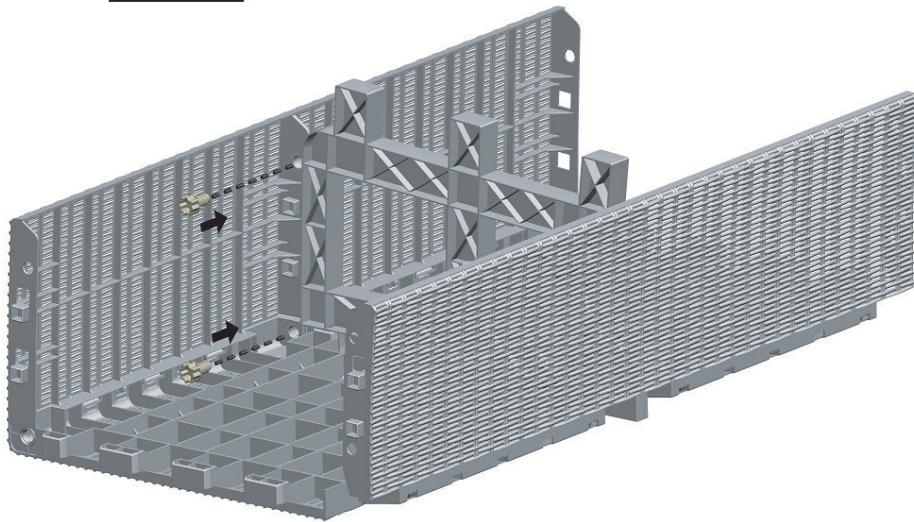

x1

Steps 12 & 13

Step 12

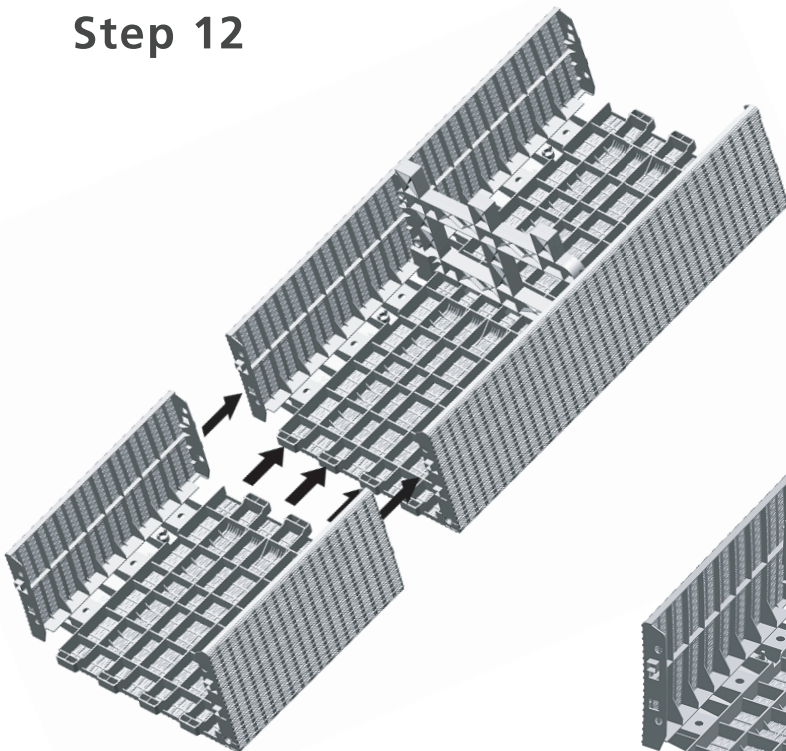

Step 13

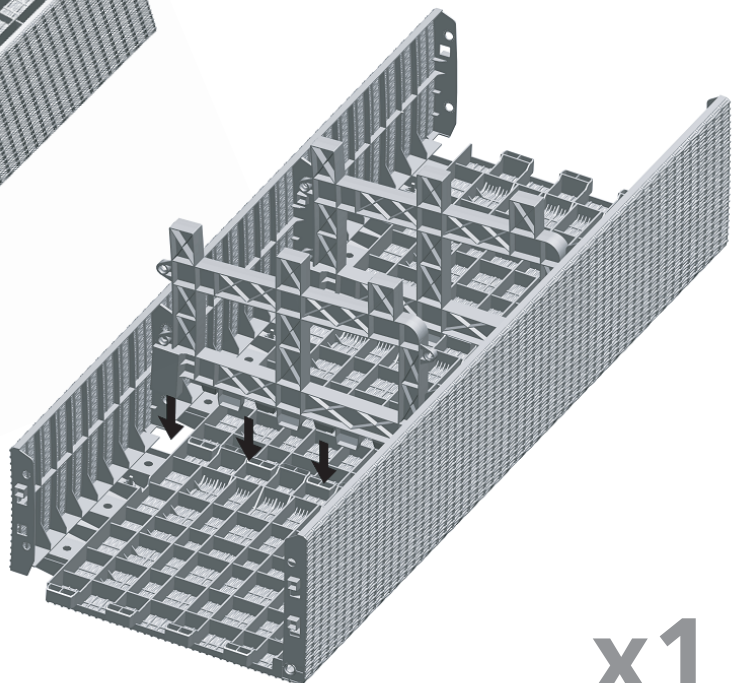

x1

Step 14

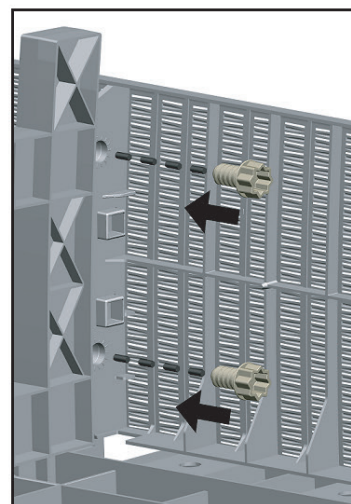
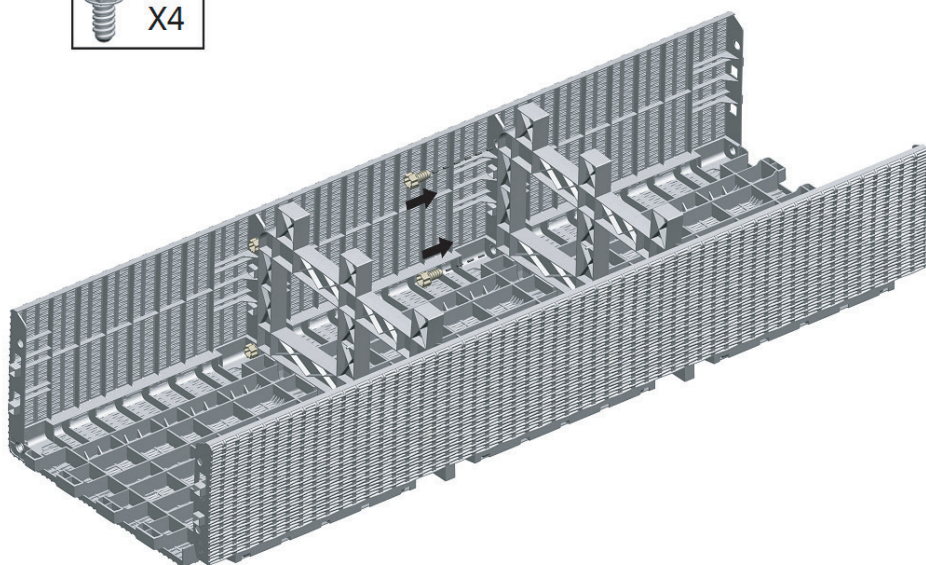

x1

Step 15

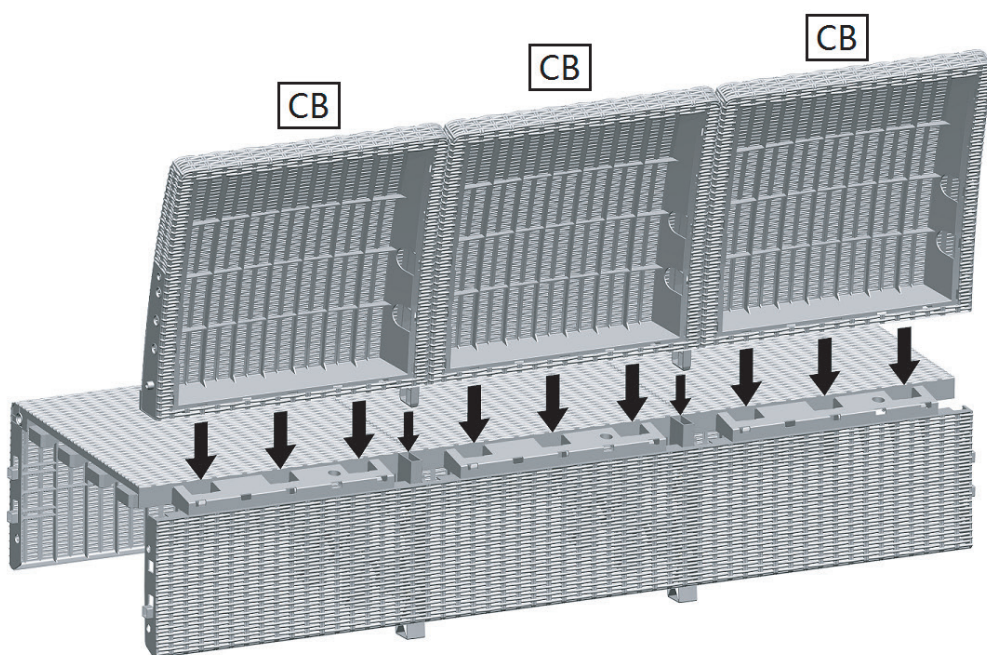

x1

Steps 16 & 17

Step 16

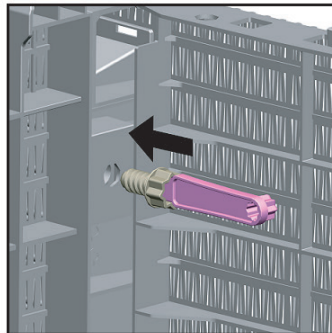
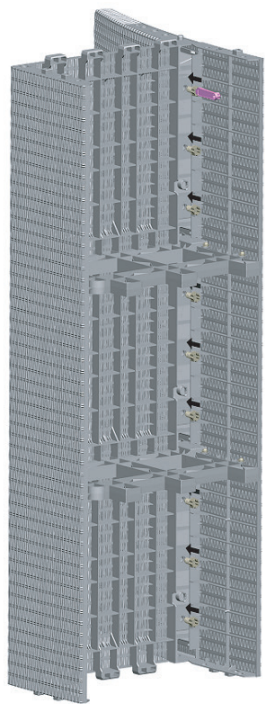

Step 17



x1

Steps 18 & 19

Step 18

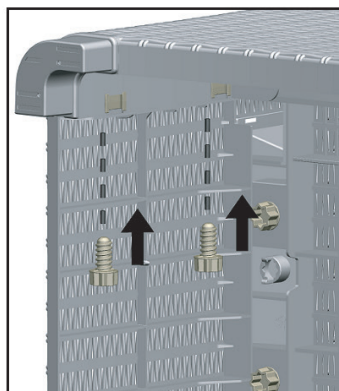

Step 19

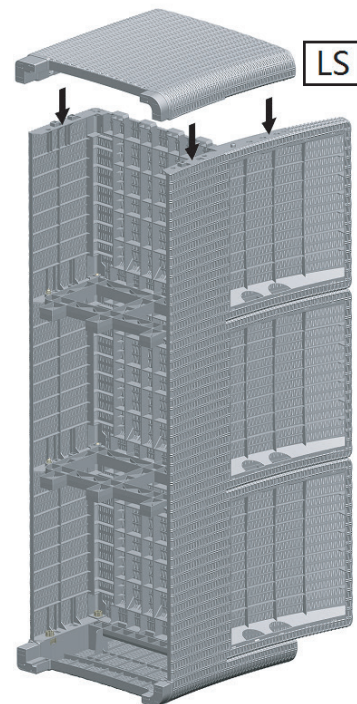

x1

Steps 20 & 21

Step 20

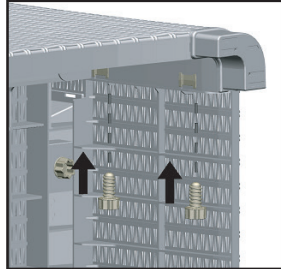
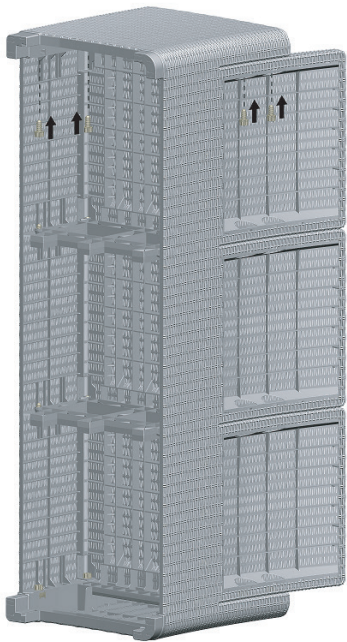

Step 21

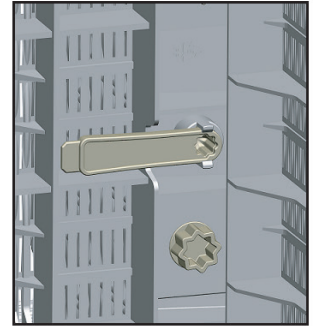
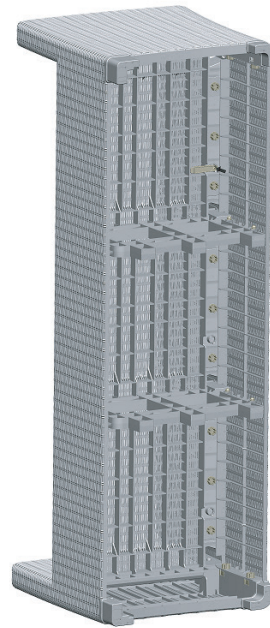





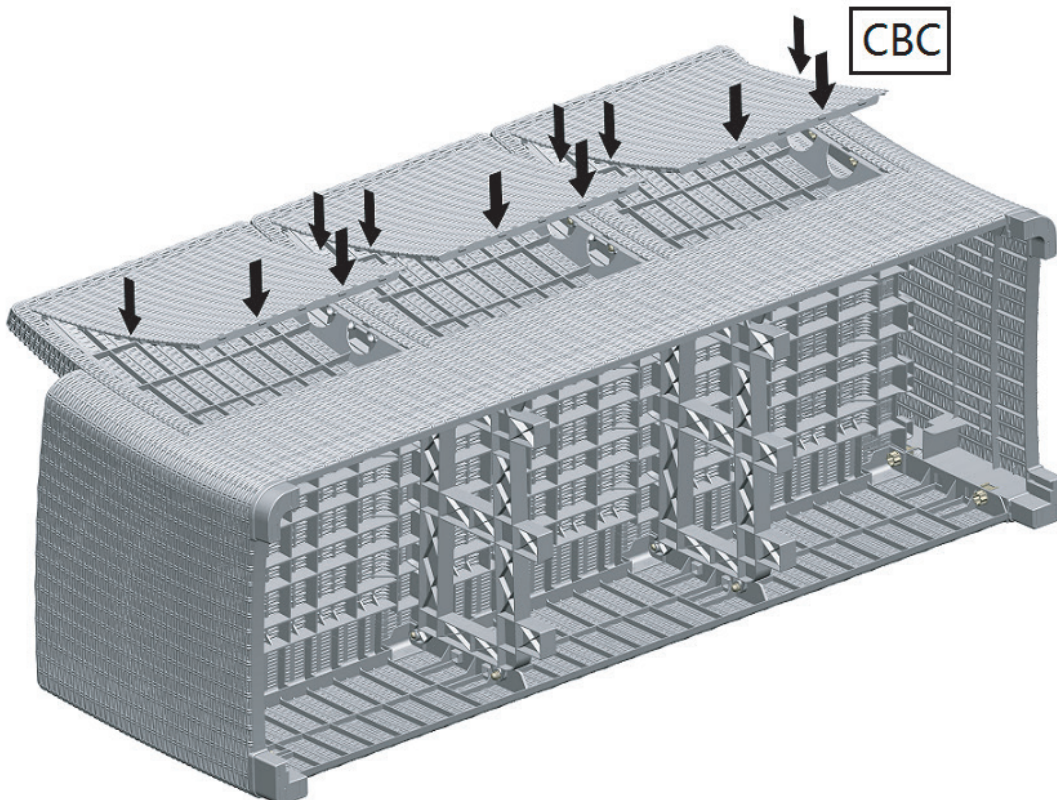





x1

Step 22



x1

Care & Maintenance

-  Do not put hot items directly on furniture surface
-  Do not clean furniture with harsh cleansers or polish.
-  To obtain the longest lifespan of your outdoor products, minimizing exposure to direct sunlight is recommended.
-  Children should not climb or jump on the furniture.
-  Do not write on furniture without a padded barrier to protect the surface.
-  To obtain the longest lifespan of your outdoor products, avoid extended and lengthy exposure to rain, snow, and direct sunshine. Whenever possible cover the product and /or place under patio or awnings.
-  Not for commercial use. For residential use only.
-  Stains may be removed with mild soap solution and damp cloth.
-  Keep away from sources of ignition.
-  Dust and pick-up spills using a clean, non-colored, lint-free cloth.



" WARNING Prop 65: This product can expose you to chemicals including Di(2-ethylhexyl)phthalate (DEHP), which is known to the State of California to cause cancer, birth defects or other reproductive harm. For more information, go to <https://www.p65warnings.ca.gov/>."

Product Warranty Information

DUKAP warrants to the Original Purchaser who acquired a new product from DUKAP or its authorized resellers that this product will be free from defects in its workmanship and materials, under normal use and service conditions, as described herein. "Defects" as used in this warranty, is defined as any imperfections that impair the use of the furniture or product. DUKAP will replace any defective part, at its discretion, and without charge to the original purchaser other than the freight from the end consumer to DUKAP.

Replacement parts can only be supplied if parts are available. Items out of production may be unavailable. This warranty will be effective for the applicable time period beginning the date of purchase on your original sales receipt. DUKAP's obligation under this warranty is limited to repairing or replacing products or parts as provided herein. This product has been designed for and is intended for outdoor and residential use only. This warranty is Original Purchaser's sole remedy for product defects, and this warranty does not extend to any product, or damage to any product, caused by or attributed to abuse or misuse, products used for commercial or rental purposes, use modifications of, or attachments to the product, and products or parts not used, maintained, or extended hereunder is in lieu of any and all other warranties, express or implied, including without limitations any implied warranty or merchantability or of fitness for a particular purpose. Please note, that exposing these products constantly to rain, snow and direct sunshine, may lower the lifespan of the product and damage the material. Damage of this nature is not covered under this warranty.

DUKAP will not be responsible for indirect, special, incidental or consequential damages. This warranty is limited to merchandise purchased in the Continental United States. Some States do not allow the exclusion or limitation of incidental or consequential damages, so the above limitations or exclusions may not apply to you. This warranty gives you specific legal rights. You may also have other rights that may vary from state to state.

DUKAP will advise you of the procedure to follow in making warranty claims. The following are the procedures for warranty claims:

a. Call us Monday – Friday, from 9am-5pm (Eastern Time) at 1(844)-554-6872 to explain the defect and give your name, address and phone number. Please have ready the model number of our product, date and place of purchase. You can also write to us by e-mail to info@dukapgear.com and include the same information.

b. If we determine that replacement will remedy the situation, and in order to determine the extent or the cause of the defect, purchaser will need to send the part in question at purchaser's expense. Once we receive the part, we will examine it and determine whether the claim is valid (or not), and then proceed to send the replacement. We will ship the replacement at our expense.

All returned items require an RA (Return Authorization) number, which can only be provided by a DUKAP Customer Service Representative when the return request is submitted. Items received without an RA may not be accepted or may increase your return processing time. Once an item has been received by DUKAP, refunds or replacements will be processed within 5 business days.

All returns must be shipped back to the DUKAP Return Center at the customer's expense. If the reason for return is a result of an error by DUKAP then DUKAP will provide a pre-paid shipping label via email. Boxes for return shipping will not be provided by DUKAP, and is the customer's responsibility to either use the original shipping boxes or purchase new boxes.

Pictures may be required for some returns to ensure an item is not damaged prior to its return. Items returned are not considered undamaged until they are received by DUKAP and verified as such. All damages to items are the customer's responsibility until the item has been received by and acknowledge by DUKAP as undamaged.