

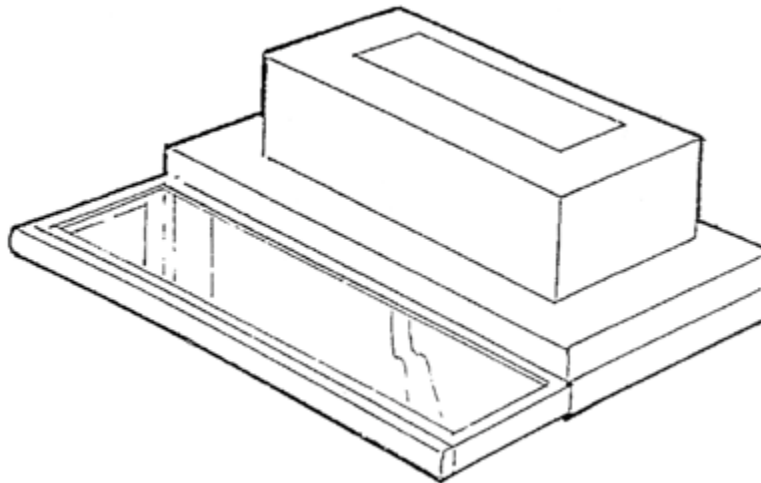

# Royale



**RETRACTABLE RANGE HOOD**  
**RR6WH, RR6BL, RR6SS**  
**RR9WH, RR9BL, RR9SS**



## RR Series - ROYALE

ITEM	DESCRIPTION	RR6WH	RR6BL	RR6SS
1*	FAN BOX			
2*	FAN BOX FRONT COVER			
3	CORD CLIP	106167	106167	106167
4	POWER CORD	103821	103821	103821
5	CAPACITOR	102793	102793	102793
6	POWER RESISTOR	102690	102690	102690
7	MOTOR/Fan Assy & Cap'r	102767	102767	102767
8	MOTOR MOUNTING BRACKET	102438	102438	102438
9	BELLMOUTH E220	103194	103194	103194
10	FRONT HANDLE 600 ASSY	103774WH	103774BL	103775SS
11	END CAP FAMILY	103778WH	103778BL	103778BL
12	SLIDER	102245	102245	102245
13	OUTER EXTRUSION	103104WH	103104BL	103104SS
14	SLIDER BRACKET-LEFT	103109WH	103109BL	103117SS
15	SLIDER BRACKET-RIGHT	103108WH	103108BL	103116SS
16	TRAY	103111WH	103111BL	103113SS
17	GLASS	102742	102742	102742
18*	BODY WELDMENT			
19	CONTROL PANEL ASSEMBLY	103131WH	103131BL	103133SS
20	LAMP HOLDER	101104	101104	101104
21	40W CANDLE GLOBE	102722	102722	102722
22	MICRO-SWITCH	102527	102527	102527
23	SLIDE SWITCH ASSEMBLY	103417WH	103417BL	103417BL
24	LIGHT DIFFUSER	103125	103125	103125
25	FILTER-'P'	102728	102728	102728
25	CHARCOAL FILTER x2 (600)	102925	102925	102925
26	FILTERTRAY	102660WH	102660BL	102662SS
27	FILM-EXHAUST COVER	102790	102790	102790
28	MICRO-SWITCH BRACKET	103114	103114	103114
29**	Heat Alarm PCB	102746	102746	102746

NOTE: \* parts are not available outside production.

\*\*Not used in production for units date stamped post June 2003 production.

## RR Series - ROYALE

ITEM	DESCRIPTION	RR9WH	RR9BL	RR9SS
1*	FAN BOX			
2*	FAN BOX FRONT COVER			
3	CORD CLIP	106167	106167	106167
4	POWER CORD	103821	103821	103821
5	CAPACITOR	102793	102793	102793
6	POWER RESISTOR	102690	102690	102690
7	MOTOR/Fan Assy & Cap'r	102767	102767	102767
8	MOTOR MOUNTING BRACKET	102438	102438	102438
9	BELLMOUTH E220	103194	103194	103194
10	FRONT HANDLE 900 ASSY	103776WH	103776BL	103777SS
11	END CAP FAMILY	103778WH	103778BL	103778BL
12	SLIDER	102245	102245	102245
13	OUTER EXTRUSION	103104WH	103104BL	103104SS
14	SLIDER BRACKET-LEFT	103109WH	103109BL	103117SS
15	SLIDER BRACKET-RIGHT	103108WH	103108BL	103116SS
16	TRAY	103111WH	103111BL	103113SS
17	GLASS	102742	102742	102742
18*	BODY WELDMENT			
19	CONTROL PANEL ASSEMBLY	103132WH	103132BL	103132SS
20	LAMP HOLDER	101104	101104	101104
21	40W CANDLE GLOBE	102722	102722	102722
22	MICRO-SWITCH	102527	102527	102527
23	SLIDE SWITCH ASSEMBLY	103417WH	103417WH	103417WH
24	LIGHT DIFFUSER	103125	103125	103125
25	FILTER-'Q'	102743	102743	102743
25	CHARCOAL FILTER x3 (900)	102926	102926	102926
26	FILTERTRAY	102661WH	102661BL	102663SS
27	FILM-EXHAUST COVER	102790	102790	102790
28	MICRO-SWITCH BRACKET	103114	103114	103114
29**	Heat Alarm PCB	102746	102746	102746

NOTE: \* parts are not available outside production.

\*\*Not used in production for units date stamped post June 2003 production.

## 'Robinhood' Retractable Rangehood

**WARNING: DISCONNECT POWER SUPPLY BEFORE SERVICING.**

### **A) TO REPLACE MOTOR:**

- 1 PULL CANOPY OPEN. REMOVE FILTERS AND WORKING FROM UNDERSIDE UNFASTEN 3 'a' SCREWS. SEE DIAGRAM BELOW.
- 2 UNFASTEN 5 SCREWS TO REMOVE THE FAN BOX FRONT COVER FROM THE FAN BOX.
- 3 UNFASTEN 2 'b' SCREWS/NUTS TO REMOVE THE MOTOR ASSEMBLY.
- 4 CUT CABLE TIES AND DISCONNECT WIRES ATTACHED TO THE TERMINAL BLOCK ON TOP OF THE MOTOR MOUNTING BRACKET.
- 5 REMOVE MOTOR ASSEMBLY FROM RANGEHOOD THROUGH FAN BOX FRONT OPENING.
- 6 REMOVE AND REPLACE MOTOR AND CAPACITOR FROM THE MOTOR MOUNTING BRACKET.
- 7 REFER TO THE WIRING DIAGRAM FOR WIRING DETAILS.
- 8 RE-ASSEMBLE RANGEHOOD IN REVERSE TO PROCEDURE ABOVE, USING CABLE TIES ON WIRES TO ENSURE THEY WILL NOT COME INTO CONTACT WITH THE MOTOR.

### **UNDERSIDE VIEW OF RANGEHOOD**

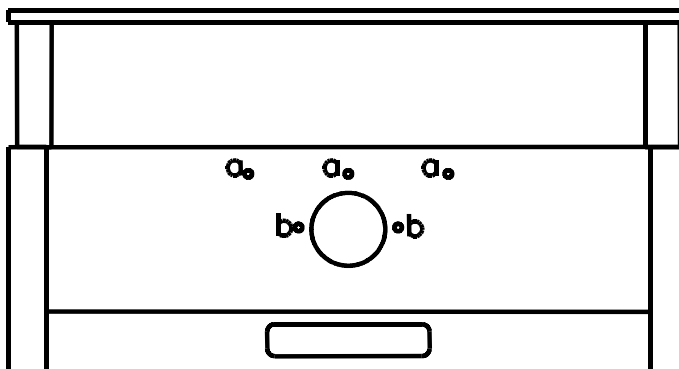

**B) TO REPLACE SWITCHES:**

- 1 PULL CANOPY OPEN, REMOVE FILTERS AND UNFASTEN SCREWS FIXING CONTROL PANEL TO BODY.SEE DIAGRAM BELOW.
- 2 DROP CONTROL PANEL SLIGHTLY AND PULL FORWARD TO DISENGAGE THE REAR TABS FROM THE BODY.
- 3 LIGHT & FAN SWITCH AND MICRO-SWITCH ARE LOCATED INSIDE THE CONTROL PANEL.
- 4 REFER TO WIRING DIAGRAM FOR WIRING DETAILS.
- 5 REASSEMBLE RANGEHOOD IN REVERSE TO PROCEDURE ABOVE, USING CABLE TIES ON WIRES WHERE NECESSARY.

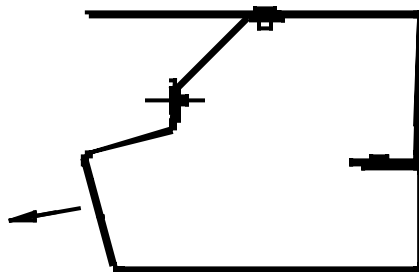

**B) TO REPLACE HEAT ALARM:** (Not applicable for units manufactured post June 2003 production.)

- 1 PULL CANOPY OPEN, REMOVE FILTERS AND FAN BOX FRONT COVER AS DESCRIBED IN SECTION A.
- 2 REMOVE HEAT ALARM COVER BY UNFASTENING THE MOUNTING SCREW.
- 3 SQUEESE THE LOCKING BARBS OF THE PCB SUPPORT THROUGH THE MOUNTING HOLES TO RELEASE THE HEAR ALARM
- 4 REFER TO WIRING DIAGRAM FOR WIRING DETAILS.
- 5 REASSEMBLE RANGEHOOD IN REVERSE TO PROCEDURE ABOVE, USING CABLE TIES ON WIRES WHERE NECESSARY.
- 6 TEST OPERATIONS OF HEAT ALARM - REFER TO HEAT ALARM OPERATING INSTRUCTION.

RR Series - ROYALE

WIRING DIAGRAM WITH  
HEAT ALARM PRE JUNE 2003  
PRODUCTION.

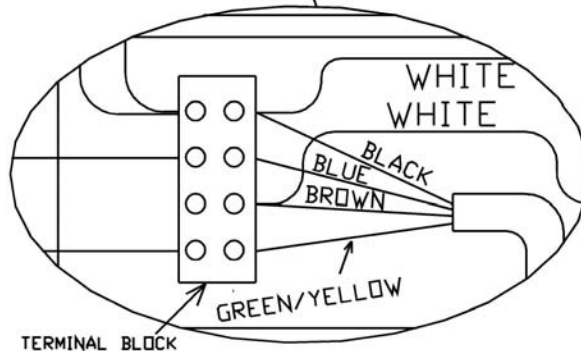
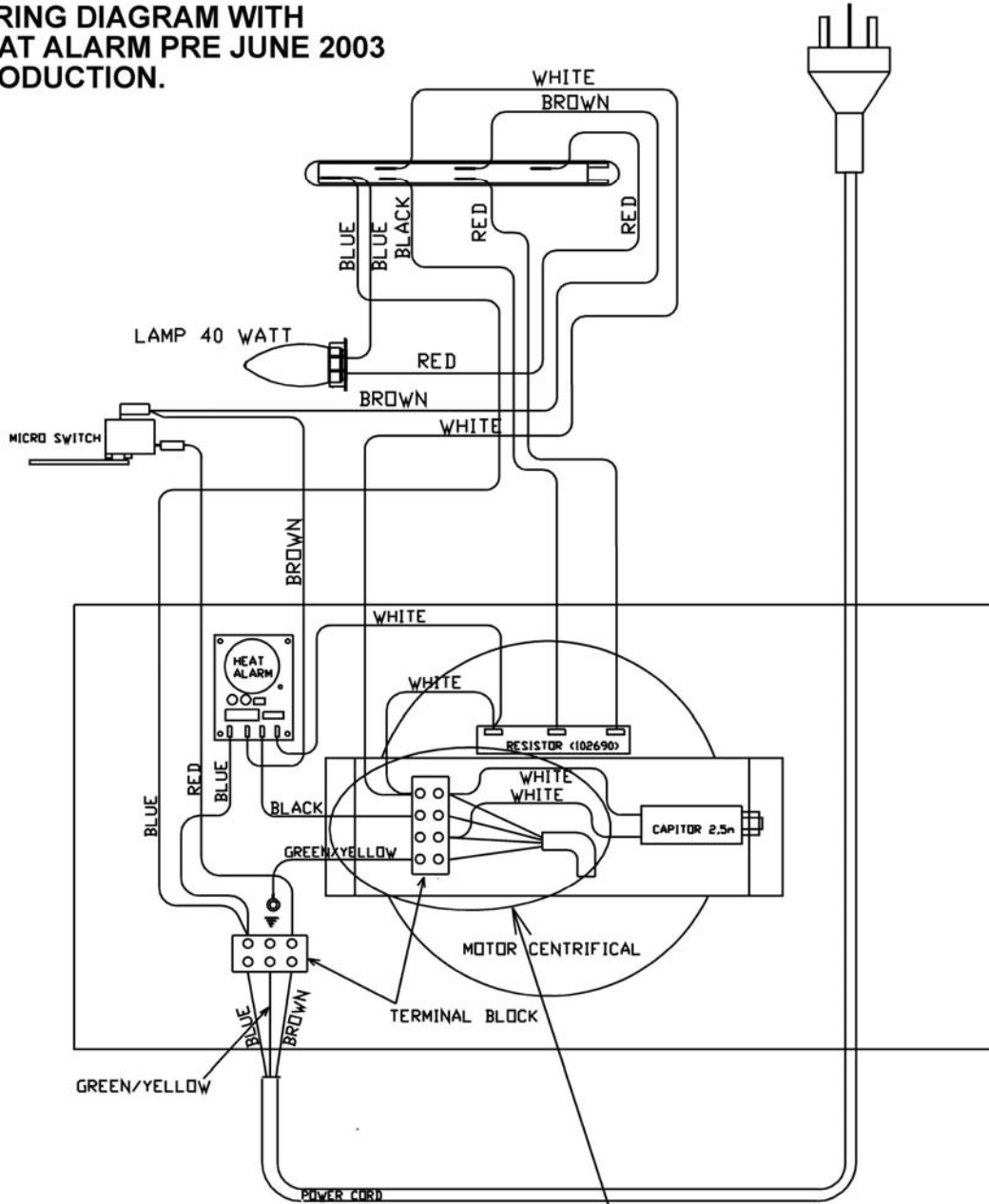

ENLARGED TERMINAL BLOCK TO CLARIFY WIRING COLOURS.

# RR Series - ROYALE

WIRING DIAGRAM WITHOUT  
HEAT ALARM. POST JUNE 2003  
PRODUCTION.

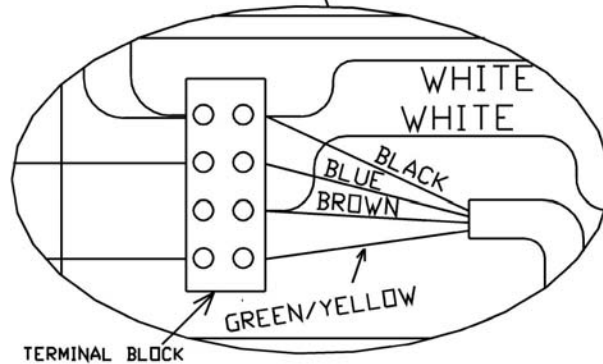
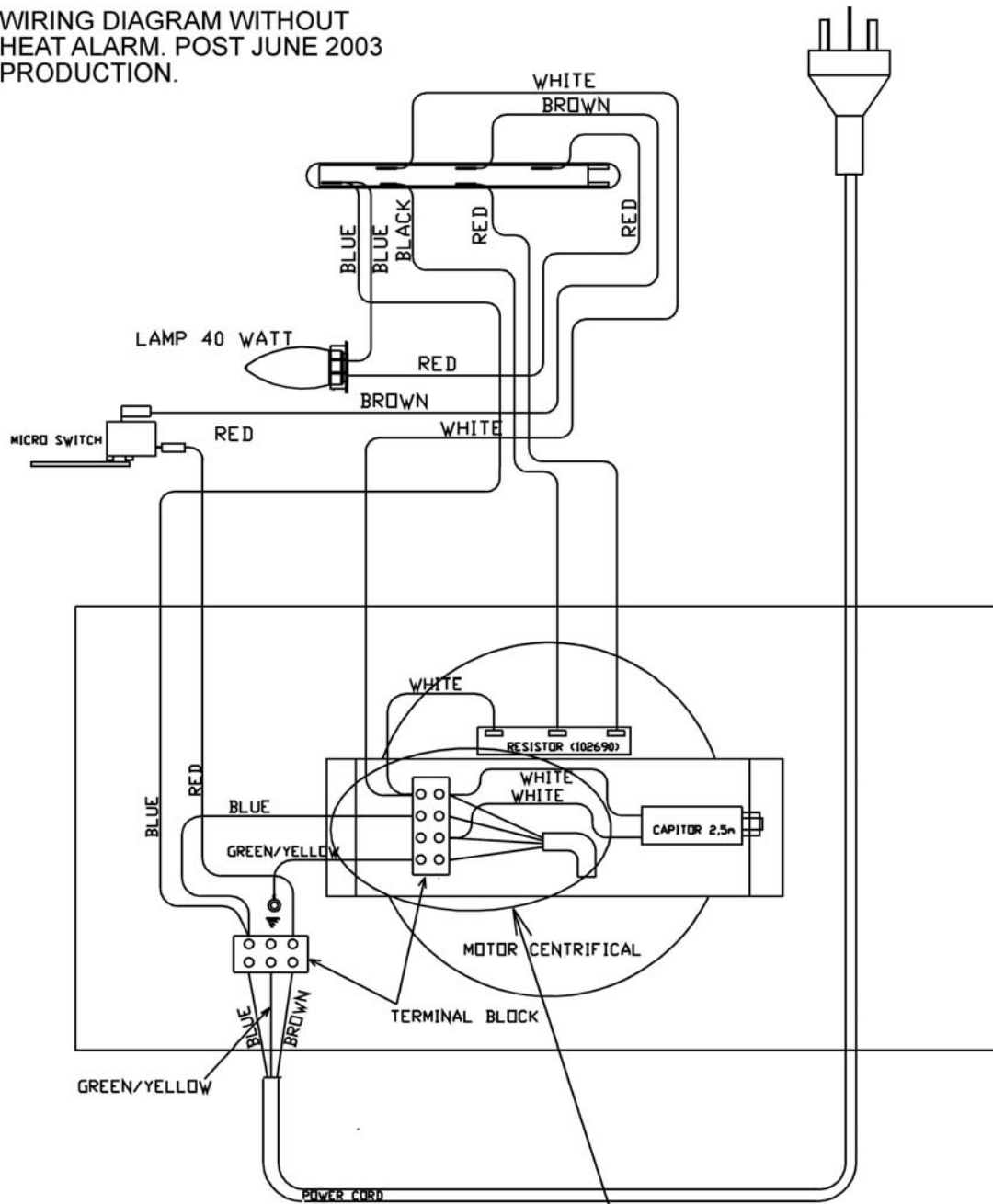

ENLARGED TERMINAL BLOCK TO CLARIFY WIRING COLOURS.