

Description: **ROBINHOOD UNDERMOUNT RANGE HOOD**
Model Numbers: **RPD3CL6WH, RPD3CL6BK, RPD3CL7WH, RPD3CL7BK, RPD3CL9WH, RPD3CL9BK,**

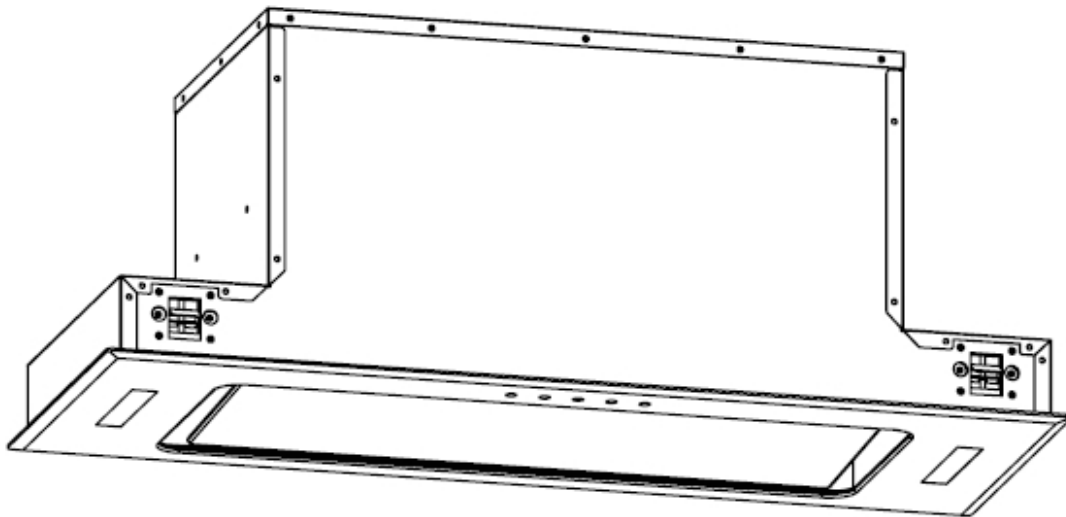











Model pictured: **RPD3CL6WH, RPD3CL6BK, RPD3CL7WH, RPD3CL7BK**
RPD3CL9WH, RPD3CL9BK

Model may vary slightly from images pictured

Pre-installation

Thank you for purchasing a quality Robinhood range hood. Robinhood has a high standard of quality control and every range hood is tested and approved before it leaves the factory.

Important:

-  Please read the entire instructions before installing the rangehood.
-  Always switch power off prior to installation.
-  All electrical work must be done in accordance with local and national electrical codes as applicable.
-  For safety, this product must be earthed.
-  A power outlet should be within 1500mm of the power cord exit from the rangehood.
-  The socket must be accessible and enable the end user to isolate the rangehood from the power for the purpose of internal cleaning or maintenance.
-  Stainless steel or powder coat is very easily damaged during installation if abraded or knocked by tools. Protect the rangehood with the cardboard box or plastic bag during installation.
-  All ducting must comply with local requirements and building codes.
-  Suitable fixings will be required to mount this rangehood.
-  See Ducting options next page.

-  Note that Accessible parts may become hot when used with cooking appliances.

-  The minimum distance between an electric or gas hob surface and the lowest part of the rangehood is 650mm. If the instructions for the hob specify a greater distance, this has to be taken into account.

-  Stainless steel is very easily damaged during installation if abraded or knocked by tools. Protect the rangehood with the cardboard box or plastic bag during installation.

Contents of packaging:

- 1 x rangehood
- 1 x Ø150mm outlet adaptor
- 4 x ST4x8mm screws

Typical equipment required:

- electric drill
- screwdriver
- tape measure
- spirit level
- duct tape (*if ducting*)
- jigsaw and ladder(*if ducting*)

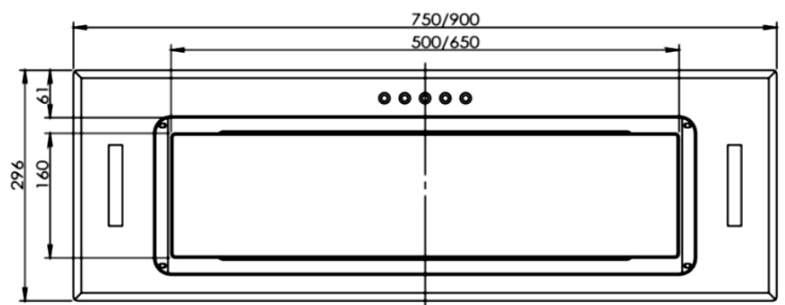
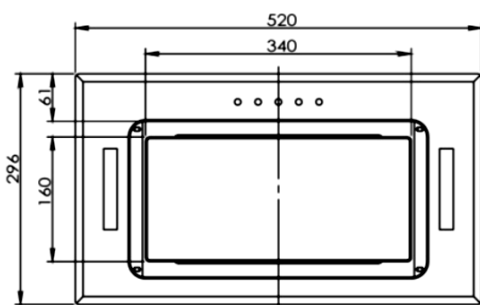

All dimensions in mm
Model may vary slightly from images pictured

Ducting Options

The method of ducting should be carefully considered before installing the rangehood. The guide below recommends the ducting components to use for all common ducting configurations - through the top of the home (for the roof and eaves) and through the rear of the home. 150mm round ducting should be used in conjunction with this model rangehood (not supplied). Alternatively this rangehood can be operated in recirculation mode.

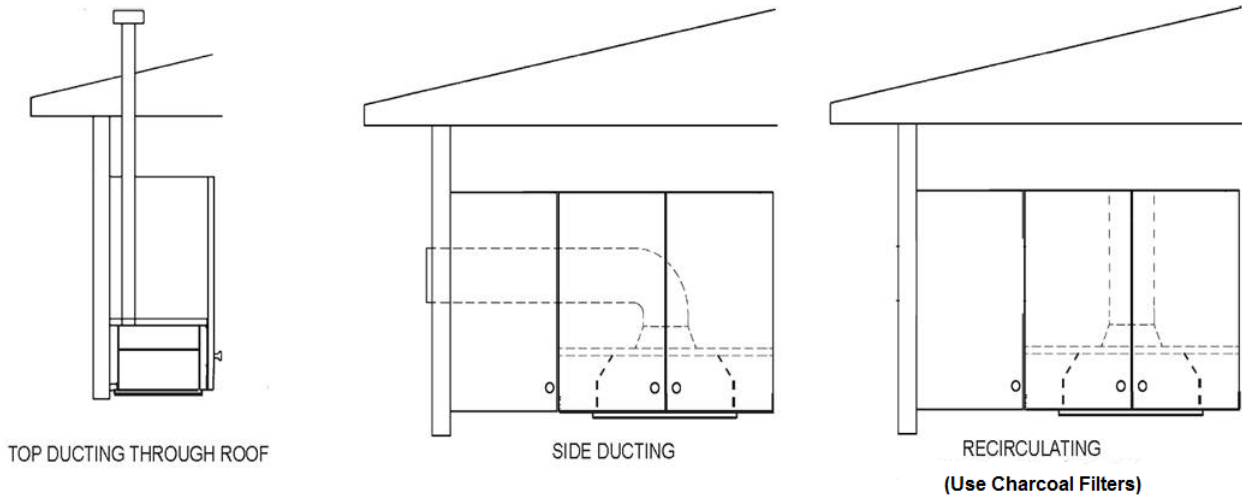

Extra lengths and/or bends may be required, depending on the length required and whether there is any structural material in the run e.g. rafters.

Please note that this chart is designed as a guide. Please consult Robinhood customer services if unsure. For NZ phone (09) 415 6000 or www.robinhood.co.nz. For AUS phone 1800 648 556 or www.robinhood.com.au.

⚠ Before drilling any holes check that the area behind the surface to be drilled is clear of any electrical cables, pipes etc. The cabinet must take a weight bearing of at least 40kgs weight. Whenever possible protect the Rangehood with a fabric sheet or similar.

When installing the rangehood, the lower edge of the unit must be a minimum of 650mm above hotplates.

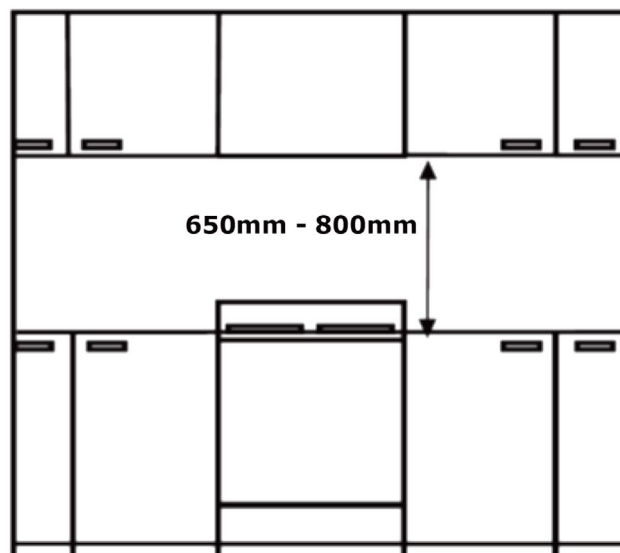

Notes: If the instructions for the cooktop specify a greater distance, this has to be taken into account. Any installation above 750mm will compromise performance.

Installation

Installation

The undermount rangehood must be installed at the correct distance above the cooktop (650mm minimum - 750mm recommended).

Cut a hole in the cabinet to fit the rangehood (RPD3CL6WH, RPD3CL6BK – 500x275mm, RPD3CL9WH, RPD3CL9BK – 880x275mm) centred above the cooktop. Make sure the hole edge should be at least **35mm** from any cupboard edge.

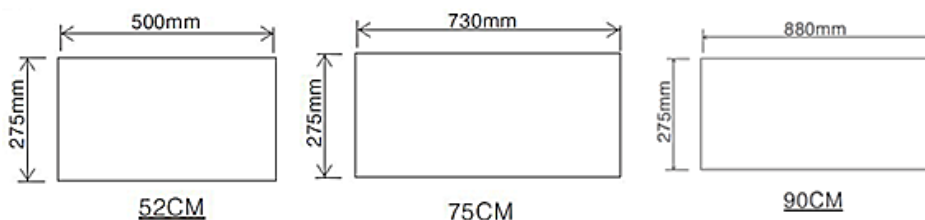

Take the plastic $\text{\O}150\text{mm}$ outlet adaptor and screw it over the square hole at the top of the appliance using the four supplied ST4x8mm screws. Check that the two half-circle flaps open outwards freely (these act as a one-way valve).

Push the appliance up into the hole and hold in place. Tighten the M4x45mm bracket screws (see diagrams below) until the rangehood is fully secured in the cabinet.

Cut a ventilation/flue hole in the cupboard (size and position will depend on the ducting method chosen).

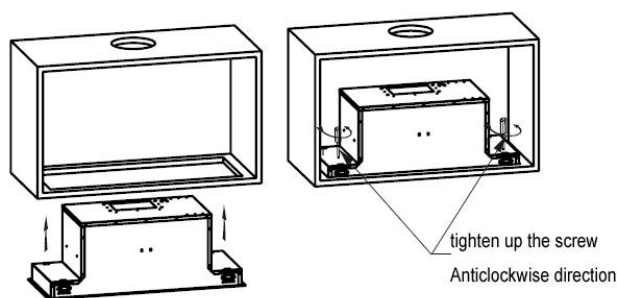

PD3CL6WH, RPD3CL6BK, RPD3CL7WH, RPD3CL7BK, RPD3CL9WH, RPD3CL9BK

Warning: Failure to install the screws or fixing devices in accordance with the instructions may result in an electrical hazard.

NOTE: This appliance can be installed to operate in recirculation mode where ducting is not a chosen/desired or practical option. Ducting may still be required to vent air from a cupboard cavity. Ensure that the top ducting outlet is not obstructed. Even a partial obstruction will restrict the efficiency of the rangehood.

When used as a recirculating rangehood, the aluminium filters must be supplemented with charcoal filters. The filter is attached to the aluminium filter with the metal strips.

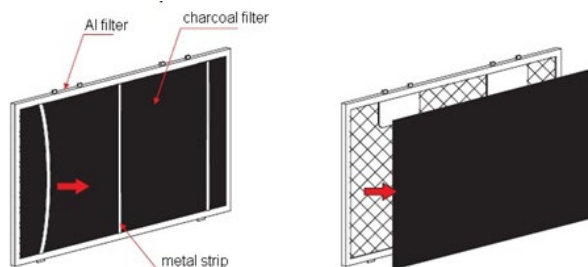

Operating instructions

Controls



LOW SPEED



MID SPEED



HIGH SPEED



LIGHTS ON/OFF



TIMER

Power

Once the appliance is connected to the power source, the backlight of the control panel will turn on for 5 seconds, and then turn off, leaving the appliance in stand-by mode. Pressing a control button will light up an indicator light while the function is active, and then turn off when the function is deactivated.

Lights

The light can be operated independently from the fan. Press the fan button once and the LED lights will turn on. Press a second time and they will turn off.

Fan speed

The exhaust fan is operated by the three fan speed buttons. Pressing the button once will turn on the fan (low, medium and high speeds) and pressing a second time will turn the fan off.

Timer

When the exhaust fan is in use, pressing the Timer button will set up a 5 minute delay, after which the appliance will return to stand-by mode. NOTE: if the lights are on, these will turn off as well, but the function will not work if only the lights are on.

Removal of Aluminium Filter

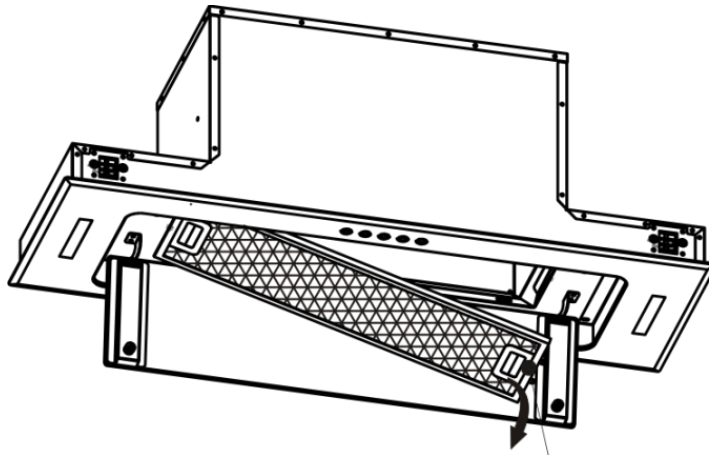



To remove the aluminium filters, first unclip the centre section of the bottom panel and let it swing down. Push in the latch at the handle (see diagrams) and remove. To install, repeat the operation in reverse.

Cleaning and maintenance

General Maintenance

Switch off the rangehood before cleaning or maintenance.

 To prevent surface damage never use abrasive or oil based liquid cleaners. To clean the surfaces of the appliance, use mild detergent and warm water. In areas of high humidity and coastal environments cleaning should be carried out frequently.

 Warning: a build-up of oil may occur if the undermount rangehood is not cleaned regularly.

Filter Maintenance

To maintain efficiency, the filters should be removed regularly (approximately monthly), and washed using hot soapy water or the dishwasher.

 Some discolouration of the filter frame may occur if washed in the dishwasher.

Rangehoods fitted with charcoal filters are designed to remove grease and odours from cooking vapours prior to the cleansed air re-entering the kitchen (when the rangehood is in recirculation mode). Charcoal filters should be replaced every two to four months depending on use.

 Fully saturated charcoal filters can become a barrier to air movement therefore limiting rangehood performance. In the event of fire, grease laden filters could be flammable and therefore regular replacement is recommended. In ducted installations, conventional aluminium filters are recommended.

Replacement of LED Lamps

The LED lamps cannot be replaced by the consumer. If any faults occur, please ring your nearest Service Department.

Replacement parts

- Charcoal filter

RPD6CF152 (RPD3CL6WH, RPD3CL6BK)
RPD7CF152 (RPD3CL7WH, RPD3CL7BK)
RPD9CF152 (RPD3CL9WH, RPD3CL9BK)

For any other problems please call help line on NZ 0800 760 667 or AUS 1800 648 556















Cleaning and maintenance

Fault	Cause	Solution
Lights do not work, but fan works	The LED damaged	Contact Service Department
	LED wiring connection poor	
	LED switch damage	
Lights work, but fan does not work	Motor bearings damage	Contact Service Department
	Motor burn out	
	Motor control switch damage	
Light does not work, motor does not work	Plug contact outlet bad	Fix or change
	Power wire cut off	Change power wire
	Switch damage	Contact Service Department
Appliance vibrates violently	Motor screw loosen	Contact Service Department
	Fixing brackets loose	Tighten the fixing brackets
Insufficient suction	The distance between the body and the cooktop too long	Readjust the distance
	Cross-ventilation too strong or too closed in the kitchen	Reduce cross-ventilation or open the window
	Exhaust pipe too long	Adjust the length of pipe
	Air outlet valve not open	Check the valve if flexible
	The outside wind is too strong	Shield outlet from wind

Product approvals and ratings

Product rating	Appliance: 268W 220-240V ~50Hz LED: 2x1.5W
Electric approval AS/NZS	60335.2.31:2013
EMC AS/NZS	CISPR 14.1:2010
Performance tested	IEC61591

Important safety information

-  All electrical work must be done by a registered electrician in accordance with local and national electrical codes as applicable. For your safety, this product must be earthed.
-  If the supply cord of this equipment is damaged, it must only be replaced by the manufacturer or its service agent or a similarly qualified person in order to avoid a hazard.
-  This rangehood is designed for indoor use only and must be in a dry location.
-  Disconnect the power supply when changing light bulbs.
-  This appliance is not intended for use by persons (including children) with reduced physical, sensory or mental capabilities, or lack of experience and knowledge, unless they have been given supervision or instruction concerning use of the appliance by a person responsible for their safety.
-  Young children should be supervised to ensure that they do not play with the appliance.
-  There shall be adequate ventilation of the room when the rangehood is used at the same time as appliances burning gas or other fuels.
-  There is a fire risk if cleaning is not carried out in accordance with the instructions. You must read the details concerning the method and frequency of cleaning.
-  Do not flambé under the rangehood.
-  Exhaust air must not be discharged into an existing flue which is used for exhausting fumes from appliances burning gas or other fuels.
-  The minimum distance between the hob surface and the lowest part of the rangehood is 650mm. If the instructions for the hob specify a greater distance, this has to be taken into account.
-  Attention should be given to ensure that any applicable regulations concerning the discharge of exhaust air is fulfilled. If recirculating, take care no ventilation becomes blocked or partially blocked.
-  Caution: Accessible parts may become hot when used with cooking appliances.
-  **WARNING:** Failure to install the screws or fixing devices in accordance with these instructions may result in an electrical hazard.
-  You must read and follow the details concerning the method and frequency of cleaning.

Notes:

- Please remember to fill out the details on the warranty certificate (do not post).
- Remove any plastic coating from the product.
- Ensure all screws are fitted and tightened.

Warranty Certificate (New Zealand)

Terms and Conditions

The following conditions apply in respect of the warranty given in this certificate:

1. Monaco Corporation Limited ("Monaco") warrants the following Robinhood products against manufacturing defects and faulty materials, under normal use and subject to the exclusions in this certificate, for a period of:
Rangehood, Ovens, Cooktops, Dishwashers - 24 months from date of original purchase for domestic use.
Uniduct – 12 months from date of original purchase for domestic use.
Ironing centre – 12 months from date of original purchase for domestic use.
Taps, including Pull-out and Mixer taps – 5 years on parts only from date of original purchase domestic for use, 24 months parts and labour from date of original purchase for domestic use
Sinks sets– 5 years on stainless steel sink including draining bench from date of original purchase for domestic use, 6 months on all stainless steel accessories, including wire rack, colander and tray from date of original purchase for domestic use.
Laundry Tub - 5 years on stainless bowl, 24 months on Tap, Cabinet and other components from the date of original purchase for domestic use.

"Original purchase", when used in this certificate, means purchase by the customer directly from Monaco or one of its approved suppliers.

2. This warranty is limited to the repair or replacement, at our option, within the warranty period of any component part which we at our discretion determine to contain faulty materials or a manufacturing defect in breach of this warranty. This warranty is subject to terms and conditions set out in this certificate.
3. The warranty only applies within New Zealand.
4. The customer must produce the original invoice or other purchase documentation as proof of the original purchase date.

Warranty exclusions

1. The warranty does not apply where, in Monaco's opinion:
The defect is caused by misuse, wear and tear, dirt, fire or accidental damage.
The product has been repaired or serviced by an unauthorised person.
The product was not installed in accordance with our instructions.
The product was purchased overseas or was not designed for use in New Zealand.
The product was not used, cleaned or cared for in accordance with our instructions.
The product was used outdoors.
2. In addition, this warranty does not extend to damage or defects which in our opinion, directly or indirectly arise from or are due to:
Exposing the product to acidic or corrosive materials or chemicals such as dyes, solvents, denture cleaner or acetone;
Using inappropriate household cleaning products such as abrasive cream or powder cleansers, furniture polish, bleach, mentholated spirits, drain cleaners, sugar soap, metal pads and strongly alkaline or acidic cleaners;
Heat damage, including from washing the product at high temperatures;
Impact or mishandling the product, including the impact caused by objects scraped along, thrown or dropped on the product surface or excessive weight being placed on the product;
Structural or support changes in or affecting the building or the application where the product has been installed;
Failure to clean or maintain the product as recommended; or
any other causes specified in the product information as being excluded from this warranty.
3. Variations with the colour or gloss within the product or any ageing or fading of colour, shine or gloss level over time are not covered by this warranty. The warranty does not cover visual imperfections or blemishes in the surface and edges of the product that were not brought to your supplier's attention at the time you inspected the product.
4. Costs incurred on installation or removal of a product, or any reinstallation of a product, or any associated costs, are not covered by this warranty.
5. Monaco will not be liable for consequential or indirect loss or damage whatsoever and however arising out of or in connection with the supply, performance or removal of the product, including (but not limited to) loss of profit, loss of revenue, loss of contract, loss of goodwill or increased cost of workings, even if due to the negligence of Monaco or any of its approved suppliers, employees or agents.
6. Charcoal filters and light bulbs are not covered by this warranty
7. This warranty and the statements contained in this certificate or other documents given to you do not exclude, restrict or modify the application of any term implied into this warranty by statute, provided that (to the extent any statutory provision permits Monaco to limit its liability for a breach of an implied condition or warranty) Monaco's liability for such breach is limited to the payment of the cost of replacing the product, repairing the product or acquiring an equivalent product.
8. Subject to clause 5, our obligations under this warranty are limited to those set out in this certificate, and this warranty is expressly instead of all other warranties, express or implied, including any implied warranty of merchantability or fitness for a particular purpose and notwithstanding any course of dealing between the parties or custom and usage in trade to the contrary.

Terms and conditions are subject to change.

Warranty Certificate (Australia)

Terms and Conditions

If you are a consumer under the Australian Consumer Law, our goods come with guarantees that cannot be excluded under the Australian Consumer Law. You are entitled to a replacement or refund for a major failure and for compensation for any other reasonably foreseeable loss or damage. You are also entitled to have the goods repaired or replaced if the goods fail to be of acceptable quality and the failure does not amount to a major failure

1. Shriro Australia Pty Limited ("Shriro") also warrants the following Robinhood products against manufacturing defects and faulty materials, under normal use and subject to the exclusions in this certificate, for a period of:

Rangehood, Ovens, Cooktops, Dishwashers - 24 months from date of original purchase for domestic use.

Uniduct – 12 months from date of original purchase for domestic use.

Ironing centre – 12 months from date of original purchase for domestic use.

Taps, including Pull-out and Mixer taps – 5 years on parts only from date of original purchase domestic for use, 24 months parts and labour from date of original purchase for domestic use

Sinks sets– 5 years on stainless steel sink including draining bench from date of original purchase for domestic use, 6 months on all stainless steel accessories, including wire rack, colander and tray from date of original purchase for domestic use.

Laundry Tub - 5 years on stainless bowl, 24 months on Tap, Cabinet and other components from the date of original purchase for domestic use.

"Original purchase", when used in this certificate, means purchase by the customer directly from Shriro or one of its approved suppliers.

2. This warranty is limited to the repair or replacement, at our option, within the warranty period of any component part which we at our discretion determine to contain faulty materials or a manufacturing defect in breach of this warranty. This warranty is subject to terms and conditions set out in this certificate.

3. The warranty only applies within Australia.

4. For warranty service outside of capital city metropolitan area or 30 km from nearest authorised service agent you will be liable for reasonable travelling expenses and the cost of transport of the product or parts to and from the service agent

5. To make a claim under this warranty, you must produce the original invoice or other purchase documentation as proof of the original purchase date.

You must send your claim to Shriro Australia Pty Limited, 104 Vanessa Street, Kingsgrove NSW 2208 within 7 days of any alleged defect or failure of the product first becoming apparent, you are responsible for the expense of making a claim under this warranty.

This warranty is given by:

Shriro Australia Pty Ltd

ABN 28 002 386 129

Telephone: 1800 648 556

Facsimile: 1800 628 577

Email: enquiries@robinhood.com.au

www.robinhood.com.au

Attention Customer Services Manager

Warranty exclusions

1. The warranty does not apply where, in Shriro's opinion:

The defect is caused by misuse, wear and tear, dirt, fire or accidental damage.

The product has been repaired or serviced by an unauthorised person.

The product was not installed in accordance with our instructions.

The product was purchased overseas or was not designed for use in Australia.

The product was not used, cleaned or cared for in accordance with our instructions.

The product was used outdoors.

2. All Robinhood Rangehoods are suitable for indoor use only and not suitable over BBQs or charcoal cookers designed for outdoor use.

3. In addition, this warranty does not extend to damage or defects which in our opinion, directly or indirectly arise from or are due to: exposing the product to acidic or corrosive materials or chemicals such as dyes, solvents, denture cleaner or acetone; using inappropriate household cleaning products such as abrasive cream or powder cleansers, furniture polish, bleach, mentholated spirits, drain cleaners, sugar soap, metal pads and strongly alkaline or acidic cleaners; heat damage, including from washing the product at high temperatures;

impact or mishandling the product, including the impact caused by objects scraped along, thrown or dropped on the product surface or excessive weight being placed on the product; structural or support changes in or affecting the building or the application where the product has been installed; failure to clean or maintain the product as recommended; or any other causes specified in the product information as being excluded from this warranty.

4. Variations with the colour or gloss within the product or any ageing or fading of colour, shine or gloss level over time are not covered by this warranty.

The warranty does not cover visual imperfections or blemishes in the surface and edges of the product that were not brought to your supplier's attention at the time you inspected the product.

5. We will not be responsible under this warranty for, nor pay the costs of, removing the existing product, or reinstalling the new product, or any associated costs or damages.

6. Charcoal filters and light bulbs are not covered by this warranty

The benefits given by this warranty are in addition to other rights and remedies of consumers under any law in relation to the goods which cannot be excluded.

This warranty certificate is not intended to create a contract between Shriro Australia Pty Limited and the purchaser.

New Zealand

Monaco Corporation Ltd

Telephone: (09) 415 6000

Facsimile: (09) 415 7400

Email: enquiries@robinhood.co.nz

www.robinhood.co.nz

Australia

Shriro Australia Pty Ltd

ABN 28 002 386 129

Telephone: 1800 648 556

Facsimile: 1800 628 577

Email: enquiries@robinhood.com.au

www.robinhood.com.au

