

101131340012

Installation and Operating Instructions

Issue: 1

Description: **ROBINHOOD VENTED DRYER 6KG WHITE**

Model Number: **RHVD6UDW**



Actual unit may vary from image above

Robinhood

借(通)用登记

输出

校对

电脑编号

技术要求

1. 材质: 105g 双面铜版纸;
2. 说明书规格: 136×193mm;
3. 彩色印刷, 印刷字迹清晰明了, 边框线不需要印刷;
4. 零件应符合RoHS2.0标准要求。

底图总号

版本: 20220118

江门市金环电器有限公司

签字

标记	处数	更改文件号	签字	日期
----	----	-------	----	----

Robinhood RHVD6UDW 说明书

日期

设计	工艺		
制图			
标准化	批准		
审核	日期		

图样	标记	重要度	比例
S		A	1:1
第 1 张		共 1 张	

101131340012

Installation and Operating Instructions

Issue: 1

Description: **ROBINHOOD VENTED DRYER 6KG WHITE**

Model Number: **RHVD6UDW**



Actual unit may vary from image above

Contents

Congratulations!

Thank you for choosing one of our appliances. Before you use the appliance, we strongly recommend that you read through the whole user manual which provides important safety instructions and description of the product and the proper use of its functions.

To avoid the ever-present risks involved with using an electrical appliance it is vital that the oven is installed correctly and that you read the safety instructions carefully to avoid misuse and hazards. It is important that you retain these instructions and your proof of purchase along with any other important documents about this product for future reference.

Due to continual product development, Robinhood reserves the right to alter specifications or appearances without notice.

Important Safety Instructions.....	1-2
Appliance Details.....	3
Installation.....	4-6
Operating Instructions.....	7-8
Cleaning and Maintenance.....	9
Troubleshooting.....	10
Warranty certificate (New Zealand)	11
Warranty certificate (Australia)	12

Disposal Information

- Most of the packing materials are recyclable. Please dispose of these materials through your local recycling depot or by placing them in appropriate collection containers.
- If you wish to discard this product, please contact your local authorities and ask for the correct method of disposal.

Important Safety Instructions

When using electrical appliances, in order to reduce the risk of fire, electric shock, and/or injury to persons, basic safety precautions should always be followed, including

- This appliance is not intended for use by persons (including children) with reduced physical, sensory or mental capabilities, or lack of experience and knowledge, unless they have been given supervision or instruction concerning use of the appliance by a person responsible for their safety. Young children should be supervised to ensure that they do not play with the appliance.
- The tumble dryer is not to be used if industrial chemicals have been used for cleaning.
- The lint trap has to be cleaned frequently.
- The lint trap must to be allowed to accumulate around the tumble dryer.
- Adequate ventilation has to be provided to avoid the back flow of gases into the room from appliance burning other fuels, including open fires.
- Do not dry unwashed items in the tumble dryer.
- Items that have been soiled with substances such as cooking oil, acetone, alcohol, petrol, kerosene, spot removers, turpentine, waxes and wax removers should be washed in hot water with an extra amount of detergent before being dried in the tumble dryer.
- Items such as foam rubber (latex foam), shower caps, rubber backed articles and clothes or pillows fitted with foam rubber pads should not be dried in the tumble dryer.
- Fabric softeners, or similar products, should be used as specified by the fabric softener instructions.
- The final part of a tumble dryer cycle occurs without heat (cool down cycle) to ensure that the items are left at a temperature that ensures that the items will not be damaged.
- The exhaust air must not be discharged into a flue which is used for exhausting fumes from appliances burning gas or other fuels.
- The appliance must not be installed behind a lockable door, a sliding door or a door with a hinge on the opposite to that of the tumble dryer, in such a way that a full opening of the tumble dryer door is restricted.
- If the supply cord is damaged, it must be replaced by the manufacturer, its service agent or similarly qualified persons in order to avoid a hazard.
- Oil-affected items can ignite spontaneously, especially when exposed to heat sources such as in a tumble dryer. The items become warm, causing an oxidation reaction in the oil. Oxidation creates heat. If the heat cannot escape, the items can become hot enough to catch fire. Piling, stacking or storing oil-affected items can prevent heat from escaping and so create a fire hazard.
- If it is unavoidable that fabrics that contain vegetable or cooking oil or have been contaminated by hair care products be placed in a tumble dryer they should first be washed in hot water with extra detergent - this will reduce, but not eliminate, the hazard.
- **WARNING:** Never stop a tumble dryer before the end of the drying cycle unless all items quickly removed and spread out so that the heat is dissipated.
- **WARNING:** The appliance must not be supplied through an external switching device, such as a timer, or connected to a circuit that is regularly switched on and off by a utility.
- **WARNING:** This appliance is only to be serviced by a qualified person. There are no user-serviceable parts inside.



Warning: Risk of fire / flammable material

Important Safety Instructions

- Do not place naked flame sources, such as candles, on the appliance.
- Do not locate the appliance or cord near heat sources such as radiators, heaters, air ducts or direct sunlight.
- Do not block any of the ventilation openings. Ensure that vents are not covered by newspapers, tablecloths, curtains, etc.
- Do not run the cord under floor coverings. Instead, arrange the cord away from traffic areas where it will not become a trip hazard.
- To disconnect the appliance, turn the appliance off, switch off the power outlet and remove the plug from the power outlet.
- Do not operate the appliance if it has a damaged cord or plug; after the appliance malfunctions; or has been dropped or damaged in any way. Consult the manufacturer.
- Do not attempt to repair, disassemble or modify this appliance. The warranty becomes void if not serviced or repaired by a qualified person.
- Do not place items that have been soiled with flammable liquids inside the dryer without washing them with detergent thoroughly before hand.
- Do not excessively bend, stretch, twist or bind the power cord or place heavy objects on it.
- Do not use an extension cord with this appliance.
- Do not install in a light fitting cabinet.
- Do not overload the tumble dryer.
- Ensure foreign objects do not find their way into the tub of the tumble dryer.
- The door window may be hot after a long drying cycle. Please ensure children are kept away from the machine.
- If the tumble dryer is not wall mounted, place in a flat, firm, dry and drafty place. Use the adjustable front legs to assist in leveling the dryer if need be. Do not place it on any soft material such as foam or plastic.
- Do not use flammable or combustible materials such as gas, petrol, alcohol or lacquer in the tumble dryer.
- After turning off the power supply to the tumble dryer, wait at least 2 minutes before turning it back on again.
- Please remove the transport packaging at the rear of the tumble dryer, prior to use.
- The maximum mass of dry load is 6Kg.
- Save these instructions.

INDOOR USE ONLY - this appliance is not intended for outdoor use.

Appliance details

Model	RHVD6UDW
Maximum Drying Capacity	6kg
Rated Voltage	220 – 240 V
Rated Frequency	50/60Hz
Rated Wattage	1500 W
Net Weight	23kg
Dimension (WxDxH)	600 mm x 545 mm x 700 mm

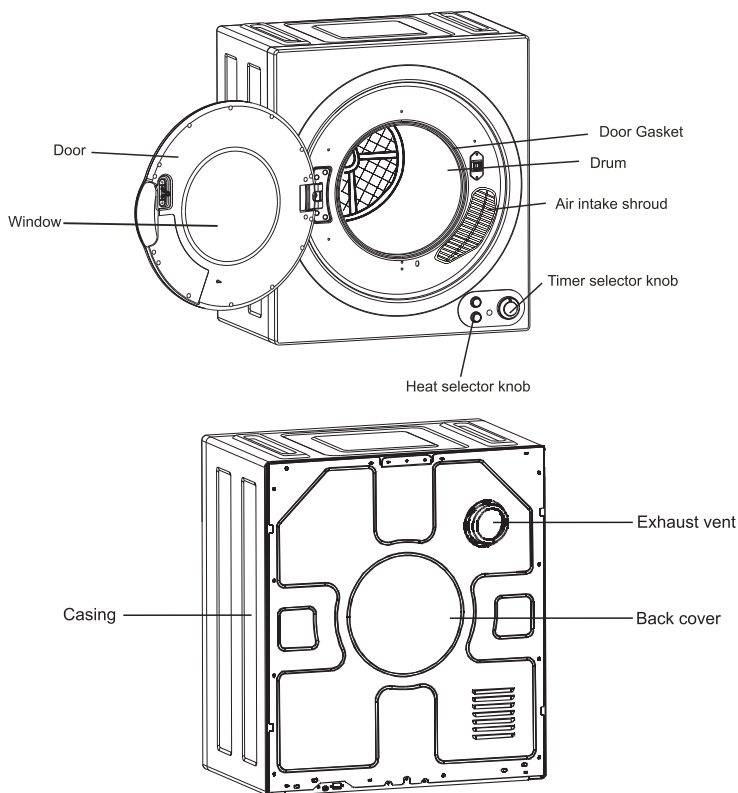

Installation Instructions

Where to place your dryer

- Place the dryer in a dry well ventilated area. It should be positioned away from heat and direct sunlight.
- If the dryer is not wall mounted, it must be placed on firm horizontal ground.
- Do not place the dryer on carpet as this will block the intake. There should be at least 15cm between the dryer and the walls.
- The dryer comes with fixed legs that need to be assembled to ensure stability.
- If the dryer is rack mounted. A secure bracket is required to ensure stability and prevent vibration. At least 15cm between the dryer and walls is required (The bracket is not included).

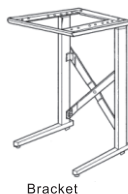
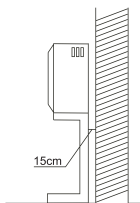
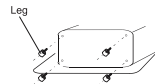

Wall mounting instructions

Tools & parts required for Plaster/Wooden wall	
Description	Quantity required
Drill & 3mm bit	1
Philips Head Screw Driver	1
Wood Screws, $\phi 12 \times 50 \text{mm}$	
Timber Screws	4
Helper to lift dryer onto wall	1 person

Wall mounting kit includes	
Description	Quantity required
Hanging brackets	2
Plastic spacers	2
Exhaust connector	1
Flexible pipe	1
25mm length screws	4
12mm length screws	4

1. Determine dryer position on wall and mark required bracket position. **Note:** This dryer is not suitable to be directly placed on top of a washing machine.

- A minimum 50mm is needed between the top of the dryer and the ceiling for ease of installation.
- If mounting above a top loading washing machine, allow sufficient room to open the lid of the washing machine.

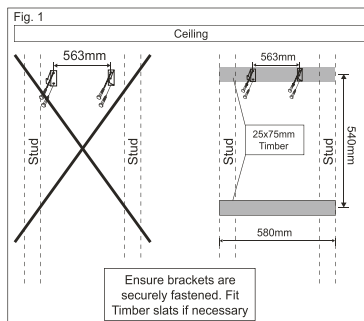
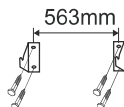

Installation Instructions Continued

- Fix the wall hanging brackets (2 supplied) to the wall securely (eg. into the stud.) Fit a timber slat between the studs to mount the brackets onto if the stud position is too wide.
- To install the hanging hook to timber. Please see Fig 2.

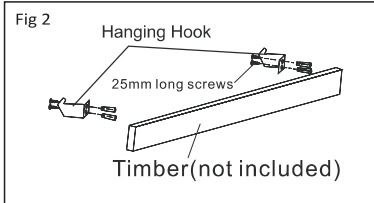

- Align hanging hooks and fasten screws tightly.
- Adjust the exhaust connector direction, then, match the exhaust connector onto the connector. Please see Fig 3.
- Turn the exhaust connector clockwise, until it insert into the connector's groove.
- Use 4 x 12mm screws (provided) to fix the 2 spacers as per Fig 4.
- With assistance, mount dryer onto the wall bracket. See Fig 5.

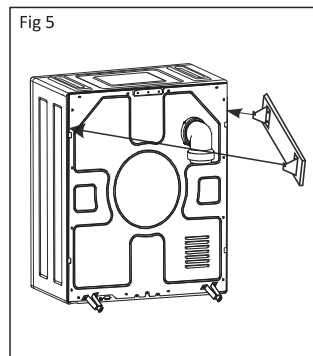
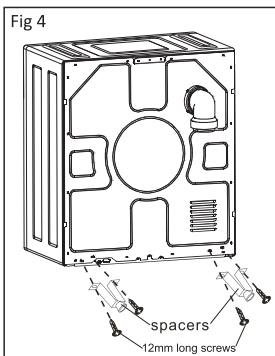
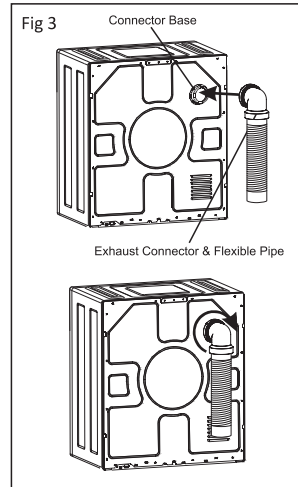

Installation Instructions- Upside down

This dryer can be installed upside down if required. Please follow below instructions:

1. Take off the rubber plugs on the top of the unit (See Fig 6). Then take off the four legs from the bottom (See Fig 7).
2. Put the dryer up-side-down and install the four legs at the bottom (Top side of the original dryer, see Fig.8). Push rubber plugs inside holes on the top of the dryer (Bottom of the original dryer, see Fig.9)
3. There is an additional control panel sticker in the accessories bag. Rip the protected paper and stick it over the existing panel, see Fig.10.

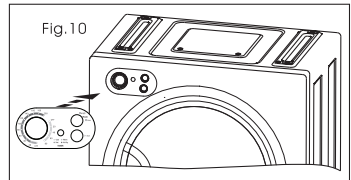
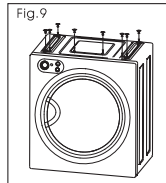
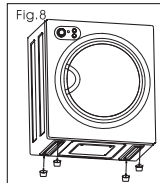
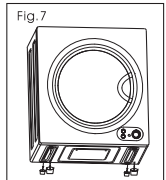
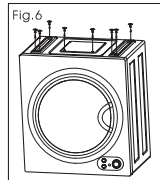

The upside down dryer can also be wall mounted by following “Installation Instruction” and “Wall Mounting Instruction” on previous page.

Operation Instructions

Electrical requirements:

- The unit is required to be plugged into a three pin socket that is reliably grounded.
- The power supply must be 220-240V. Plug the power cord into the socket.

Loading the dryer:

- It is recommended that items are placed into the dryer one at a time. This ensures they are not tangled which results in uneven drying.
- When closing the dryer door prior to starting the unit ensure that items are not jammed in the door.

Tips before drying clothes:

- Prior to loading the dryer check that the items do not have the following the symbols anywhere on them. If they do, do not tumble dry these items.
- Check the items to be dried do not have combustible materials or foreign objects within them ie: lighters, hair pins, coins.
- Turn items with zippers inside out and fasten buckles.
- Dryer heat may permanently set stains, ensure you check prior to drying that stains are removed.
- Separate dark and light colored items as you would do when washing.
- For best results load the dryer with similar fabrics. Place small delicate items in a mesh bag and do not overload the dryer.
- The maximum mass is 6Kg of dry textile material for the dryer and do not overload. The tumble dryer is intended only for drying textile material washed in water.

Drying time reference:

Drying Capacity	Drying Time	
	High	Low
Approx. 2Kg	Approx. 30 mins	Approx. 55 mins
Approx. 3Kg	Approx. 60 mins	Approx. 110 mins
Approx. 4Kg	Approx. 120 mins	Approx. 200 mins
Approx. 6Kg	Approx. 200 mins	—————

Note: Drying times can be affected by many factors, such as material, bulkiness, how full the dryer is etc. The above table is a guide only.

Operation Instructions

Control Panel Functions

Heat Selector button:

- Select 'High Dry' for items that are particularly bulky or large quantities.
- Select 'Low dry' for delicate items such as Silk, nylon, linen etc.



Start button:

- After having set up the Heat Selector and Timer Dial, press the Start button. The dryer will start and work until the program is finished.
- If during the drying process the door is opened (or power is off), the dryer will stop working. In order to restart it, you will need to close the door (or switch the power back on) and then press the Start button. The dryer will then resume operation.



NOTE: This Start button is only designed to start operation of the dryer. If you press this button during the drying process, the dryer will not pause. In order to stop the dryer, you must turn the timer dial to the Off position.

Drying program selector:

There are five drying combinations available: Cool, Anti-wrinkle, Warm, Hot and Air dry. After having set up the Heat Selector and Timer Dial, press the Start button.

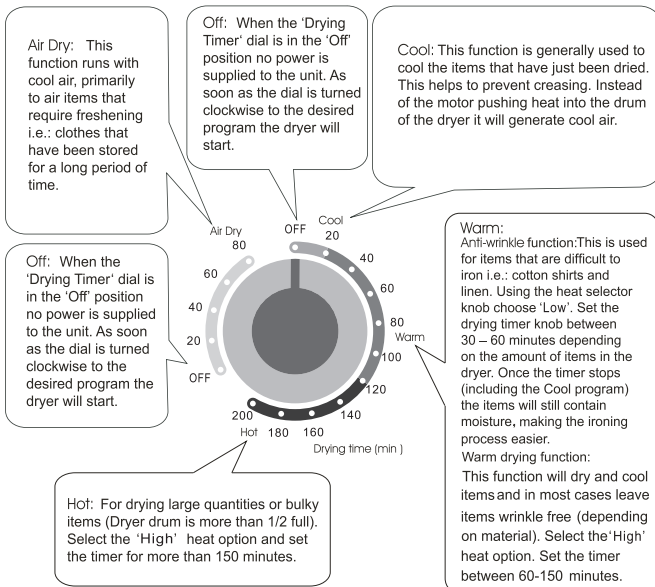

Cleaning and Maintenance

Clean the Lint filter:

Please unplug the power cord prior to any cleaning. The lint filter must be in place whenever drying. It must be cleaned before each use.

- Removing the filters: Remove by pulling outwards with fingers, inserted into the four holes around the exhaust vent shroud. The filter is in 3 parts: Exhaust vent shroud, lint filter and exhaust filter (as shown in figure 1)
- Cleaning the filter: Separate "exhaust vent shroud", "lint filter" and "exhaust filler". Clean the lint on the lint filler and exhaust filter with a soft brush or vacuum cleaner. Do not damage the filters (as shown in figure 2)
- Re-installing the filter: After cleaning, assemble in the sequence of "exhaust filler - lint filler- exhaust vent shroud", align the recesses in the center with the projection in the center of the drum. Make sure that it is firmly inserted (as shown in figure 3).

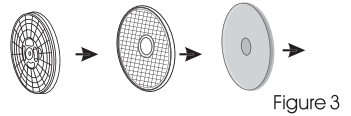
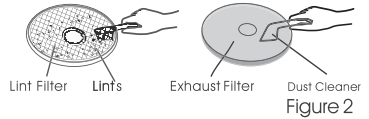
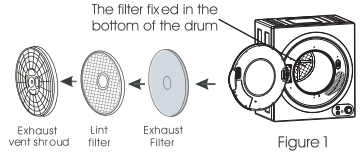

Clean the air intake filter:

The filter should be cleaned once a month.

Remove by pulling outwards holding the upper and lower ends of the air intake shroud. Remove the filter inside the shroud and clean it with a soft brush. Reassemble and install as before.

General cleaning of interior and exterior of the dryer:

- Do not wash directly with water.
- Do not use thinner, gasoline or alcohol.
- Do not use any type of spray cleaner when cleaning the interior. If dryer drum becomes stained, clean the drum with a damp cloth. Remove any residue before drying the next load. Clean cabinet with mild soap and water.
- Do not use harsh or abrasive cleaners, this could damage the dryer.



CAUTION! HOT SURFACE

- Do not touch the intake during the drying cycle due to high temperatures

READ THE INSTRUCTIONS

Trouble Shooting

Please review below table before calling for service:

Problem	Possible Cause	What to do
Timer knob does not turn	<ul style="list-style-type: none">• Is the power cord inserted firmly?	<ul style="list-style-type: none">• Insert the power cord firmly
Drum does not turn	<ul style="list-style-type: none">• Is the door closed?• Is the power cord inserted?• Does the receptacle have power?	<ul style="list-style-type: none">• Close the door.• Insert the power cord firmly.• Check the power cord receptacle.
Hot air is not blowing out	<ul style="list-style-type: none">• Is the timer incorrectly set on cold air?	<ul style="list-style-type: none">• Set the timer to hot air.
The laundry is not thoroughly dried	<ul style="list-style-type: none">• Are the front and back filters clogged?• Is there too much laundry in the dryer?• Have items been added whilst the dryer is in operation?• Has the laundry become twisted whilst drying?• Has the dryer been placed in a small and badly ventilated area?• Have you set the dryer to Anti-Wrinkle?	<ul style="list-style-type: none">• Clean the filter.• Reduce the amount in the dryer.• Re-dry the items again• Untwist the items and re-dry.• Place the dryer in a well-vented area.• Try using 'Warm' or 'Hot' setting instead
Dryer does not start	<ul style="list-style-type: none">• Is there a power failure?• Is the power cord inserted firmly?• Is the door closed?• Is the timer in the OFF position?	<ul style="list-style-type: none">• Try again when there is power• Insert the power cord firmly• Close the door• Set the dry time

Warranty Certificate (New Zealand)

Terms and Conditions

The following conditions apply in respect of the warranty given in this certificate:

1. Monaco Corporation Limited ("Monaco") warrants the following Robinhood products against manufacturing defects and faulty materials, under normal use and subject to the exclusions in this certificate, for a period of:
 - Rangehood, Ovens, Cooktops, Dishwashers, Refrigeration - 24 months from date of original purchase for domestic use.
 - Uniduct - 12 months from date of original purchase for domestic use.
 - Ironing centre - 12 months from date of original purchase for domestic use.
 - Sinks sets - 5 years on stainless steel sink including draining bench from date of original purchase for domestic use, 6 months on all stainless steel accessories, including wire rack, colander and tray from date of original purchase for domestic use.
 - Laundry Tub - 5 years on stainless bowl, 24 months on Tap, Cabinet and other components from the date of original purchase for domestic use.

"Original purchase", when used in this certificate, means purchase by the customer directly from Monaco or one of its approved suppliers.

2. This warranty is limited to the repair or replacement, at our option, within the warranty period of any component part which we at our discretion determine to contain faulty materials or a manufacturing defect in breach of this warranty. This warranty is subject to terms and conditions set out in this certificate.
3. The warranty only applies within New Zealand.
4. The customer must produce the original invoice or other purchase documentation as proof of the original purchase date.

Warranty exclusions

1. The warranty does not apply where, in Monaco's opinion:
 - The defect is caused by misuse, wear and tear, dirt, fire or accidental damage. The product has been repaired or serviced by an unauthorised person.
 - The product was not installed in accordance with our instructions.
 - The product was purchased overseas or was not designed for use in New Zealand. The product was not used, cleaned or cared for in accordance with our instructions.
 - The product was used outdoors.
2. In addition, this warranty does not extend to damage or defects which in our opinion, directly or indirectly arise from or are due to:
 - Exposing the product to acidic or corrosive materials or chemicals such as dyes, solvents, denture cleaner or acetone; Using inappropriate household cleaning products such as abrasive cream or powder cleansers, furniture polish, bleach, mentholated spirits, drain cleaners, sugar soap, metal pads and strongly alkaline or acidic cleaners;
 - Heat damage, including from washing the product at high temperatures;
 - Impact or mishandling the product, including the impact caused by objects scraped along, thrown or dropped on the product surface or excessive weight being placed on the product;
 - Structural or support changes in or affecting the building or the application where the product has been installed;
 - Failure to clean or maintain the product as recommended; or any other causes specified in the product information as being excluded from this warranty.
3. Variations with the colour or gloss within the product or any ageing or fading of colour, shine or gloss level over time are not covered by this warranty. The warranty does not cover visual imperfections or blemishes in the surface and edges of the product that were not brought to your supplier's attention at the time you inspected the product.
4. Costs incurred on installation or removal of a product, or any reinstallation of a product, or any associated costs, are not covered by this warranty.
5. Monaco will not be liable for consequential or indirect loss or damage whatsoever and however arising out of or in connection with the supply, performance or removal of the product, including (but not limited to) loss of profit, loss of revenue, loss of contract, loss of goodwill or increased cost of workings, even if due to the negligence of Monaco or any of its approved suppliers, employees or agents.
6. Charcoal filters and light bulbs are not covered by this warranty
7. This warranty and the statements contained in this certificate or other documents given to you do not exclude, restrict or modify the application of any term implied into this warranty by statute, provided that (to the extent any statutory provision permits Monaco to limit its liability for a breach of an implied condition or warranty) Monaco's liability for such breach is limited to the payment of the cost of replacing the product, repairing the product or acquiring an equivalent product.
8. Subject to clause 5, our obligations under this warranty are limited to those set out in this certificate, and this warranty is expressly instead of all other warranties, express or implied, including any implied warranty of merchantability or fitness for a particular purpose and notwithstanding any course of dealing between the parties or custom and usage in trade to the contrary.

Terms and conditions are subject to change.

Warranty Certificate (Australia)

Terms and Conditions

If you are a consumer under the Australian Consumer Law, our goods come with guarantees that cannot be excluded under the Australian Consumer Law. You are entitled to a replacement or refund for a major failure and for compensation for any other reasonably foreseeable loss or damage. You are also entitled to have the goods repaired or replaced if the goods fail to be of acceptable quality and the failure does not amount to a major failure.

1. Shriro Australia Pty Limited ("Shriro") also warrants the following Robinhood products against manufacturing defects and faulty materials, under normal use and subject to the exclusions in this certificate, for a period of:
 - Rangehood, Ovens, Cooktops, Dishwashers, Refrigeration – 24 months from date of original purchase for domestic use.
 - Uniduct – 12 months from date of original purchase for domestic use.
 - Ironing centre – 12 months from date of original purchase for domestic use.
 - Sinks sets– 5 years on stainless steel sink including draining bench from date of original purchase for domestic use, 6 months on all stainless steel accessories, including wire rack, colander and tray from date of original purchase for domestic use.
 - Laundry Tub - 5 years on stainless bowl, 24 months on Tap, Cabinet and other components from the date of original purchase for domestic use. "Original purchase", when used in this certificate, means purchase by the customer directly from Shriro or one of its approved suppliers.
2. This warranty is limited to the repair or replacement, at our option, within the warranty period of any component part which we at our discretion determine to contain faulty materials or a manufacturing defect in breach of this warranty. This warranty is subject to terms and conditions set out in this certificate.
3. The warranty only applies within Australia.
4. For warranty service outside of capital city metropolitan area or 30 km from nearest authorised service agent you will be liable for reasonable travelling expenses and the cost of transport of the product or parts to and from the service agent
5. To make a claim under this warranty, you must produce the original invoice or other purchase documentation as proof of the original purchase date. You must send your claim to Shriro Australia Pty Limited, 104 Vanessa Street, Kingsgrove, NSW, 2208, within 7 days of any alleged defect or failure of the product first becoming apparent. You are responsible for the expense of making a claim under this warranty.

This warranty is given by:

Shriro Australia Pty Ltd, ABN: 28 002 386 129

Telephone: 1800 648 556

Facsimile: 1800 628 577

Email: customercare@robinhood.com.au

www.robinhood.com.au

Attention: Customer Services Manager

Warranty exclusions

1. The warranty does not apply where, in Shriro's opinion:
 - The defect is caused by misuse, wear and tear, dirt, fire or accidental damage. The product has been repaired or serviced by an unauthorised person.
 - The product was not installed in accordance with our instructions.
 - The product was purchased overseas or was not designed for use in Australia.
 - The product was not used, cleaned or cared for in accordance with our instructions.
 - The product was used outdoors.
2. All Robinhood Rangehoods are suitable for indoor use only and not suitable over BBQs or charcoal cookers designed for outdoor use.
3. In addition, this warranty does not extend to damage or defects which in our opinion, directly or indirectly arise from or are due to: exposing the product to acidic or corrosive materials or chemicals such as dyes, solvents, denture cleaner or acetone; using inappropriate household cleaning products such as abrasive cream or powder cleansers, furniture polish, bleach, mentholated spirits, drain cleaners, sugar soap, metal pads and strongly alkaline or acidic cleaners; heat damage, including from washing the product at high temperatures; impact or mishandling the product, including the impact caused by objects scraped along, thrown or dropped on the product surface or excessive weight being placed on the product; structural or support changes in or affecting the building or the application where the product has been installed; failure to clean or maintain the product as recommended; or any other causes specified in the product information as being excluded from this warranty.
4. Variations with the colour or gloss within the product or any ageing or fading of colour, shine or gloss level over time are not covered by this warranty. The warranty does not cover visual imperfections or blemishes in the surface and edges of the product that were not brought to your supplier's attention at the time you inspected the product.
5. We will not be responsible under this warranty for, nor pay the costs of, removing the existing product, or reinstalling the new product, or any associated costs or damages.
6. Charcoal filters and light bulbs are not covered by this warranty.

The benefits given by this warranty are in addition to other rights and remedies of consumers under any law in relation to the goods which cannot be excluded.

This warranty certificate is not intended to create a contract between Shriro Australia Pty Limited and the purchaser.

New Zealand
Monaco Corporation Ltd
Telephone: (09) 415 6000
Facsimile: (09) 415 7400
Email:
enquiries@robinhood.co.nz
www.robinhood.co.nz

Australia
Shriro Australia Pty Ltd
ABN 28 002 386 129
Telephone: 1800 648 556
Facsimile: 1800 628 577
Email:
enquiries@robinhood.com.au
www.robinhood.com.au