

Description: **ROBINHOOD TOP LOAD WASHING MACHINE 7KG WHITE**

Model Number: **RHTL7W**



Model pictured: RHTL7W

Actual unit may vary from picture as above

Contents

Congratulations!

Thank you for choosing one of our appliances. Before you use the appliance, we strongly recommend that you read through the whole user manual which provides important safety instructions and description of the product and the proper use of its functions.

To avoid the ever-present risks involved with using an electrical appliance it is vital that the oven is installed correctly and that you read the safety instructions carefully to avoid misuse and hazards. It is important that you retain these instructions and your proof of purchase along with any other important documents about this product for future reference.

Due to continual product development, Robinhood reserves the right to alter specifications or appearances without notice.

Important Safety Instructions.....	1-2
Appliance Details.....	3
Installation.....	4-6
Operating Instructions.....	7-12
Cleaning and Maintenance.....	13-14
Troubleshooting.....	15
Warranty certificate (New Zealand)	16
Warranty certificate (Australia)	17

Disposal Information

- Most of the packing materials are recyclable. Please dispose of these materials through your local recycling depot or by placing them in appropriate collection containers.
- If you wish to discard this product, please contact your local authorities and ask for the correct method of disposal.

Important Safety Instructions

When using electrical appliances, in order to reduce the risk of fire, electric shock, and/or injury to persons, basic safety precautions should always be followed, including

1. This appliance is not intended for use by persons (including children) with reduced physical, sensory or mental capabilities, or lack of experience and knowledge, unless they have been given supervision or instruction concerning use of the appliance by a person responsible for their safety. Children should be supervised to ensure that they do not play with the appliance.
2. The maximum mass of dry load is 7 Kg.
3. This appliance is intended to be used in household and similar applications such as:
 - Staff kitchen areas in shops, offices and other working environment.
 - Farm house.
 - By clients in hotels, motels and other residential type environments.
 - Bed and breakfast type environments.
 - Areas for communal use in blocks of flats or in launderettes.
4. Carpet does not obstruct the opening for washing machines with ventilation openings in the base.
5. If the supply cord is damaged, it must be replaced by the manufacturer, its service agent or similarly qualified persons in order to avoid a hazard.
6. Water mains:
 - Maximum inlet water pressure 0.8MPa.
 - Minimum inlet water pressure 0.03MPa.
7. The new detachable hose sets supplied with the appliance are to be used and that old detachable hose sets should not be used.
8. Always unplug the appliance and turn off the water supply after use.
9. To ensure your safety, power plug must be inserted into an earthed three-pole socket. Check carefully and make sure that your socket is properly and reliably earthed.
10. Make sure that the water and electrical devices must be connected by a qualified technician in accordance with the manufacturer's instructions and local safety regulations.
11. Remove all packages and transport bolts before using the appliance. Otherwise, serious damage may result.
12. Power plug must be accessible after installation.
13. Washing machine shall not be installed in bath room or very wet rooms as well as in the rooms with explosive or caustic gases.
14. The washing machine with single inlet valve only can be connected to the cold water supply. The product with double inlet valves should be correctly connected to the hot water and cold water supply.
15. Your product is only for home use and is only designed for the textiles suitable for machine washing.
16. Do not climb up and sit on top cover of the machine.
17. Do not lean against machine door.
18. Cautions during Handling Machine:
 - Transport bolts shall be reinstalled to the machine by a specialized person.
 - The accumulated water shall be drained out of the machine.
 - Handle the machine carefully. Never hold each protruded part on the machine while lifting. Machine door cannot be used as the handle during the conveyance.
 - This appliance is heavy. Transport with care.
19. Please do not close the door with excessive forces. If it is difficult to close the door, please check if the clothes are put in or distributed well.
20. It is forbidden to wash carpets.
21. Flammable and explosive or toxic solvents are forbidden. Gasoline and alcohol etc shall not be used as detergents. Please only select the detergents suitable for machine washing, especially for drum.

Important Safety Instructions

22. Make sure that all pockets are emptied. Sharp and rigid items such as coin, brooch, nail, screw or stone etc. may cause serious damages to this machine.
23. Please check whether the water inside the drum has been drained before opening its door. Please do not open the door if there is any water visible.
24. Be careful of burning when the product drains hot washing water.
25. Never refill the water by hand during washing.
26. After the program is completed, Please wait for two minutes to open the door.
27. **WARNING:** The appliance must not be supplied through an external switching device, such as a timer, or connected to a circuit that is regularly switched on and off by a utility.
28. **WARNING:** This appliance is only to be serviced by a qualified person. There are no user-serviceable parts inside.
29. Unplug the power before cleaning and maintenance.
30. The appliance is not intended for built-in use.
31. Save these instructions.

INDOOR USE ONLY - this appliance is not intended for outdoor use.

Appliance details

Model	RHTL7W
Maximum Drying Capacity	7 kg
Rated Voltage	230 - 240 V
Rated Frequency	50 Hz
Rated Wattage	450 W
Dimension (WxDxH)	550 x 565 x 935 mm

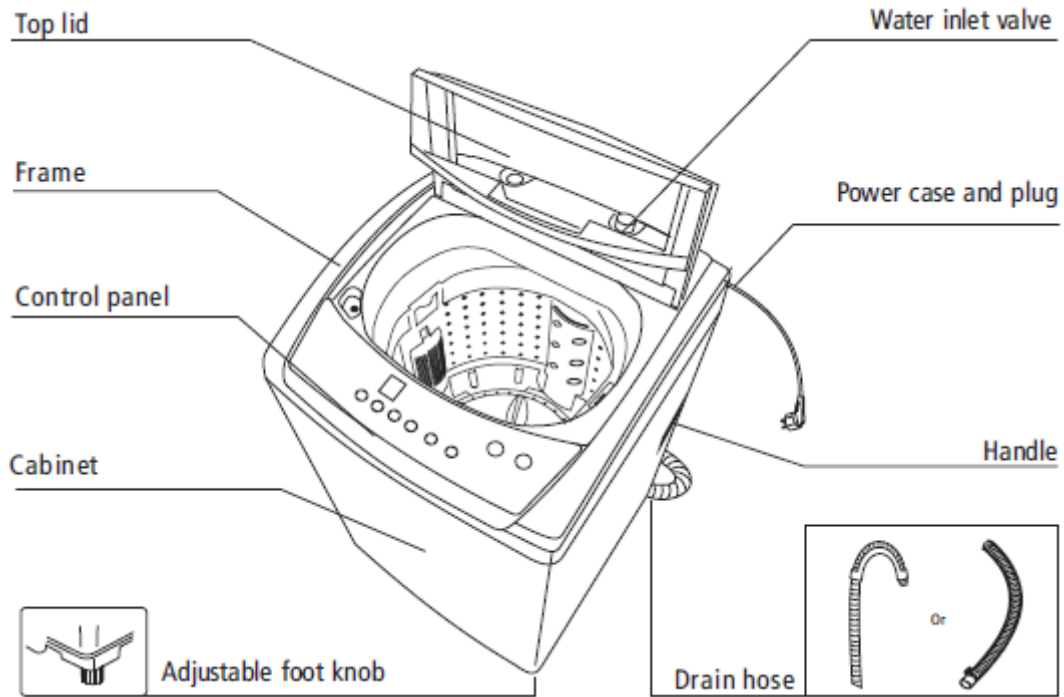

Accessories

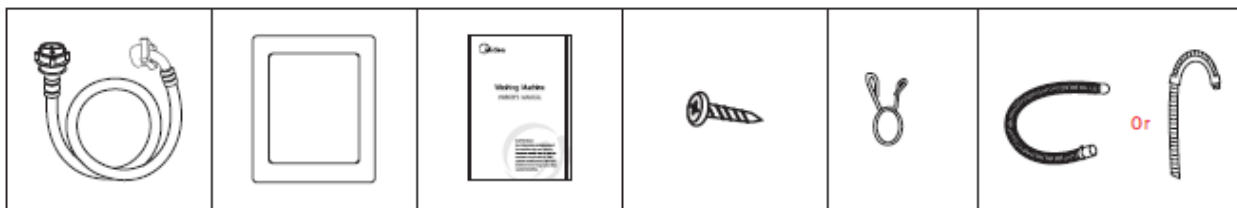

Inlet hose

Cabinet
Baseboard

Manual

Screw

Spring

Drain hose

Clamper

Note!

- If the drain hose is already installed on the machine, then there is no spring clamper and drain hose in the accessories.

Installation Instructions

Installation Area

Warning!

- Stability is important to prevent the product from wandering!
- Make sure that the product should not stand on the power cord.

Before installing the machine, the location characterized as follows shall be selected:

1. Rigid, dry, and level surface
2. Avoid direct sunlight
3. Sufficient ventilation
4. Room temperature is above 0°C
5. Keep far away from the heat resources such as coal or gas.

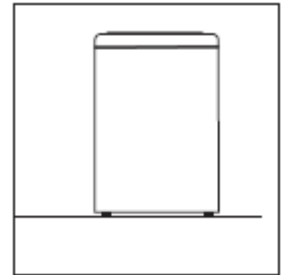
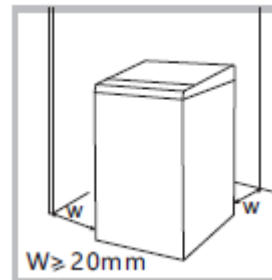

Warning!

- Packaging material (e.g. Films, Styrofoam) can be dangerous for children.
- There is a risk of suffocation ! Keep all packaging well away from children.

1. Remove the cardboard box and styrofoam packing.
2. Lift the washing machine and remove the base packing.
3. Remove the tape securing the power supply cord and drain hose.
4. Remove the inlet hose from the drum.

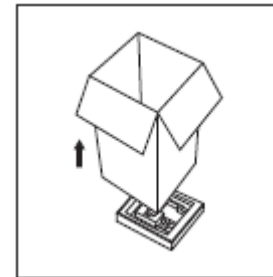

Installation of drain hose

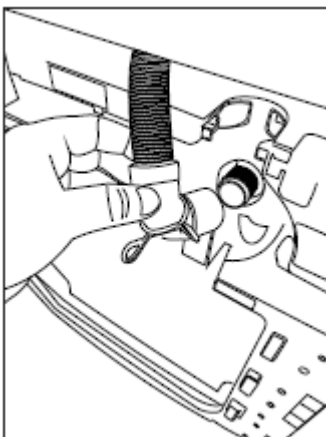

Drain hose inserted
Into the drain

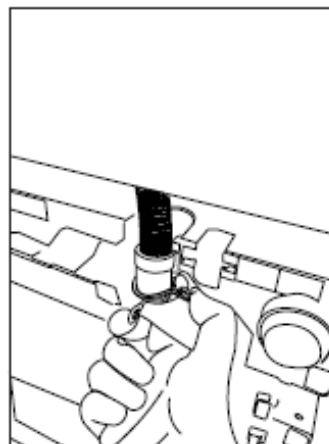

Clamping spring

Installation Instructions

Warning!

- Do not kink or protract the drain hose.
- Position drain hose properly, otherwise damage might result of water leakage.
- If drain hose is too long, do not force it into washing machine as it will cause abnormal noises.

There are two ways to place the end of drain hose:

1. For lower drain system

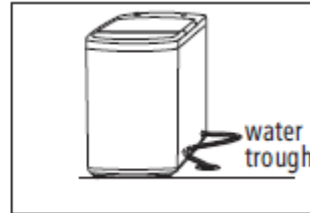
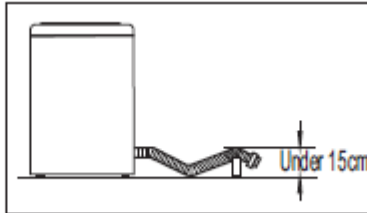
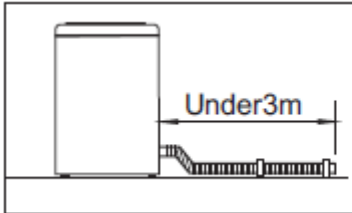

2. For higher drain system

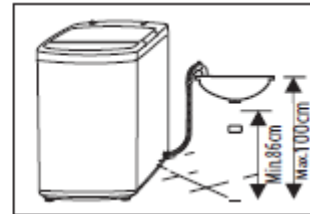
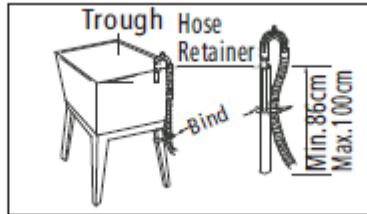
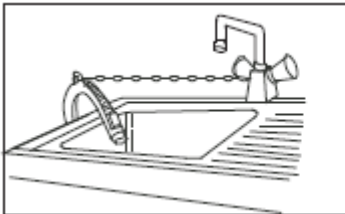

Levelling the washing machine

Warning!

- The lock nuts on all four feet must be screwed tightly against the housing.

1. Check if the legs are closely attached to the cabinet. If not, please turn them to their original positions tighten the nuts.
2. Check alignment of the product with a spirit level and if required, correct.
3. Loosen the lock nut and turn the feet until it closely contacts with the floor.
4. After being locked properly, press four corners again to make sure that they has been adjusted properly.

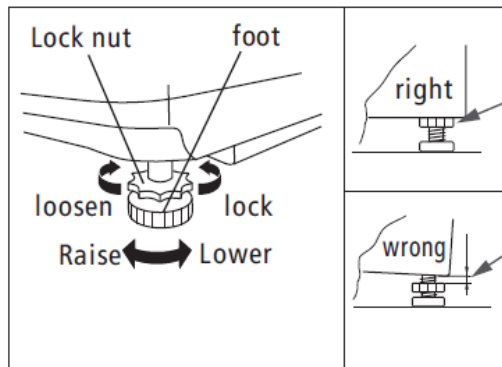

Installation Instructions

Selection of Tap

Please select appropriate tap



Connection of inlet hose, tap and washing machine

1. Connection between ordinary tap and inlet hose.

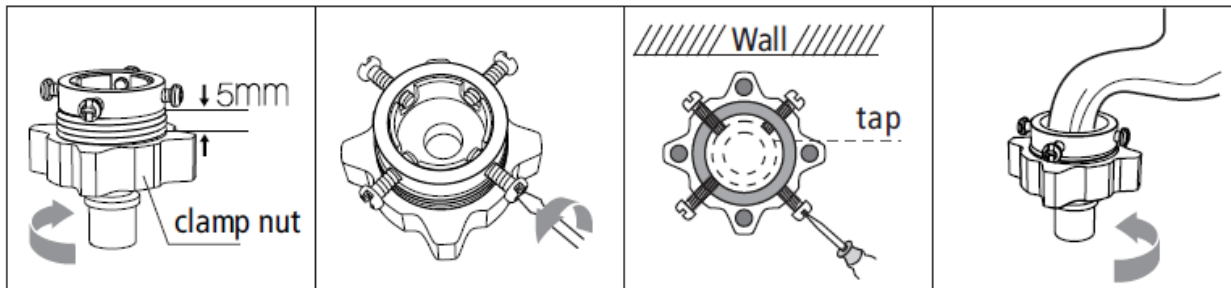

1. Loosen clamp nut to show 5 mm thread

2. Loosen four bolts

3. Set connecting base on tap and tighten bolt evenly

4. Tighten clamp nut

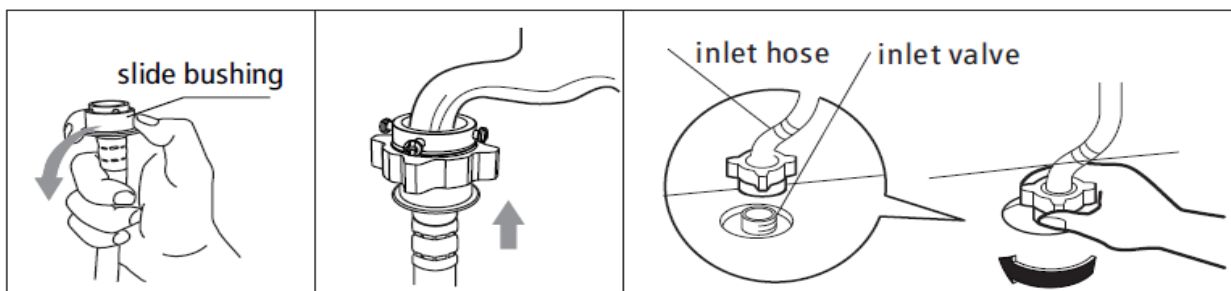

5. Press slide bushing, insert inlet hose into connecting base.

6. Connection finished

7. After connection and installation, Check if there is water leakage

2. Connection between screw tap and inlet hose.

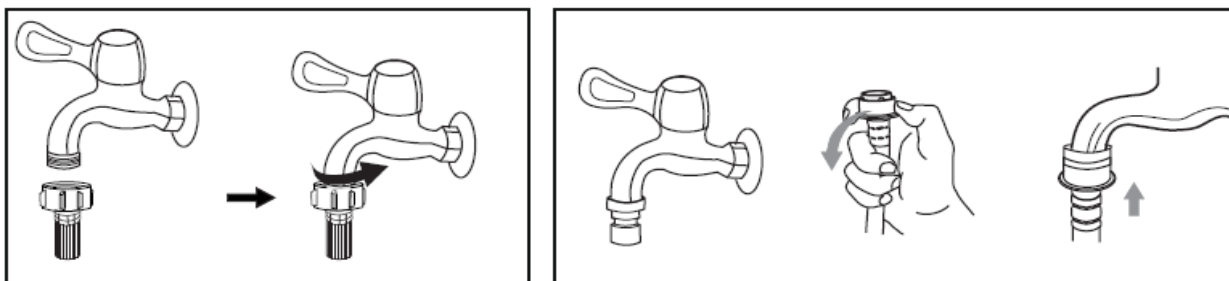

Tap with thread and inlet hose

Special tap for washing machine

Warning!

- To prevent leakage or water damage, follow the instructions in this chapter
- Do not kink, crush, modify or sever water inlet hose.

Operation Instructions

Preparation Before Washing

Caution!

- Before washing, please make sure it's installed properly.
- Before washing at first time, the washing machine shall be operated in one round of the whole procedures without clothes in as follow.

Before using the machine, please follow the tips below.

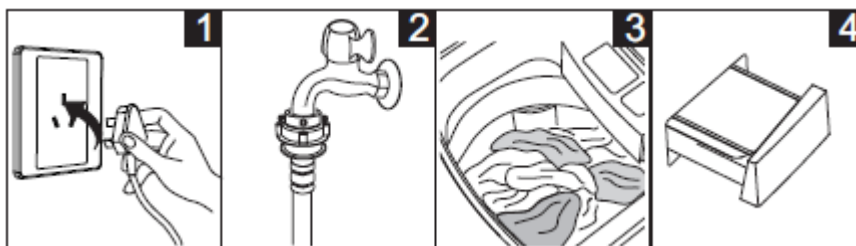

1
Power connected and turned on

2
Water connected and turned on

3
Fill machine with washing

4
Put washing powder/detergent in drawer.

Washing

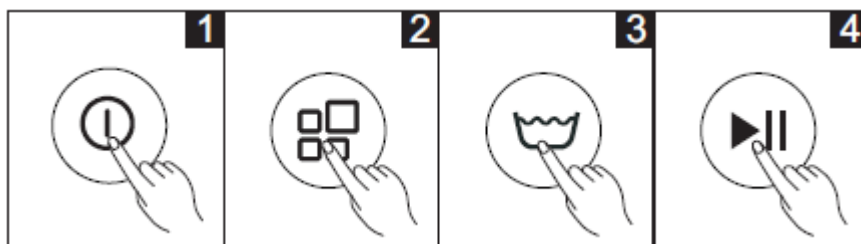

1
Power On

2
Select Program

3
Select Level

4
Start up

Note !

- If default is selected, step 2, 3 can be skipped.

After Washing

Buzzer will keep after washing finished and the power supply will be cut off automatically. Then unload the laundry.

Operation Instructions

Washing matters needing attention

- The working condition of the washer should be (0-40) °C. If used under 0°C, the inlet valve and draining system may be damaged. If the machine is placed under condition of 0°C or less, then it should be transferred to normal ambient temperature to ensure the water supply hose and drain hose are not frozen before use.
- Please check the labels and the explanation of using detergent before wash. Use non-foaming or less-foaming detergent suitable for machine washing properly.

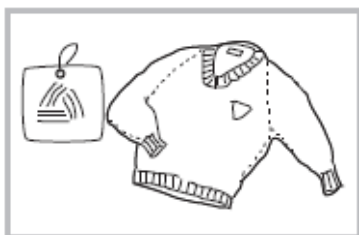

Check the label

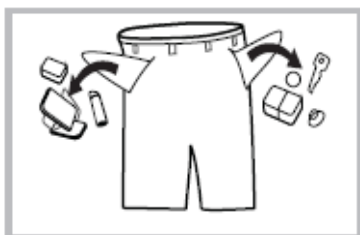

Take out the items out of the pockets

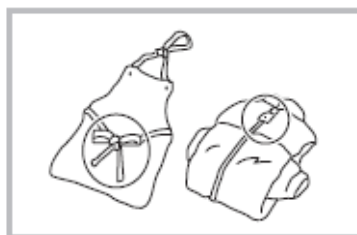

Knot the long strips, zip or button

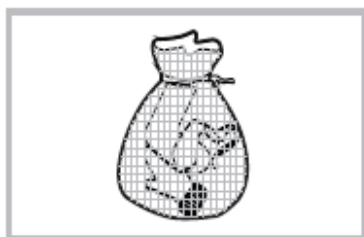

Put small clothes into the pillow slip

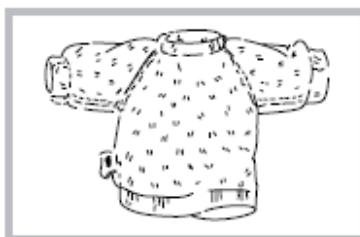

Turn easy-pilling and long-pile fabric inside out

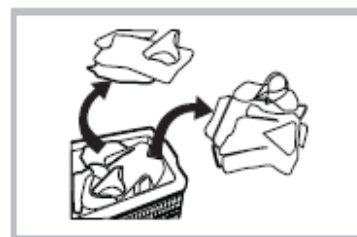

Separate clothes with different textures

Warning!

- When washing single clothes, it may easily cause great eccentricity and give alarm due to great unbalance. Therefore, it is suggested to add one or two more clothes to be washed together so that draining can be done smoothly.
- Don't washing the clothes touching with kerosene, gasoline, alcohol and other flammable materials.

The usage of detergent and washing powder

- As for the agglomerated or ropy detergent or additive, before they are poured into the detergent box, it is suggested to use some water for dilution to prevent the inlet of detergent box from being blocked and overflowing while filling water.
- Please choose suitable type of detergent for the various washing temperature to get the best washing performance with less water and energy consumption.

Operation Instructions

Control Panel

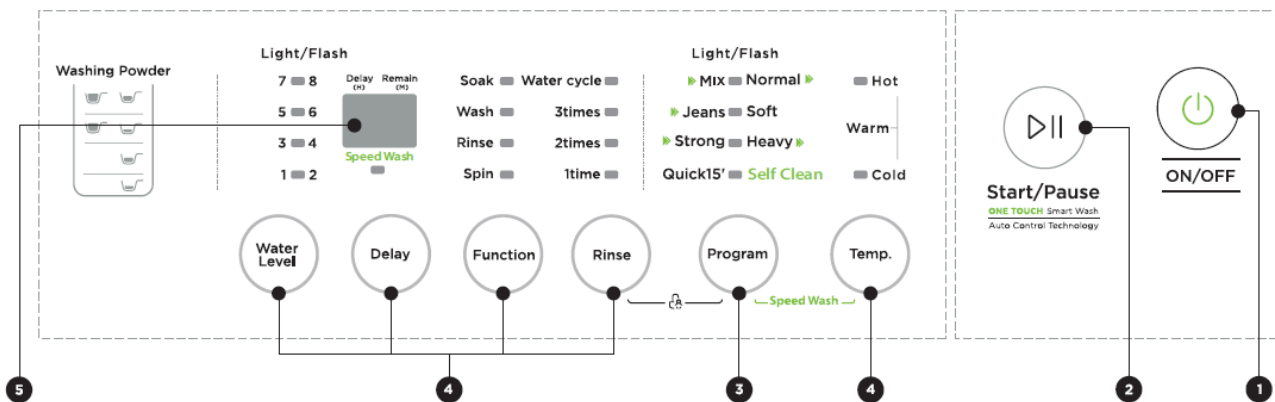

1 On/Off

Product is switched on or off.

3 Program

Available according to the laundry type.

2 Start/Pause

Press the button to start or pause the washing cycle

4 Option

This allows you to select an additional function and light when selected.

5 Display

The display shows the settings, estimated time remaining, options, and status messages for your washer. The display will remain on through the cycle. When LED flashing it means the time that delay to start the machine. When LED lighting, it means the program time that remaining

Operation Instructions

Option





 **Water Level**
Water level
select water level according to clothing categories, degree of soiling and washing habits of customers

 **Rinse**
Rinse
rinsing times settings can be selectable

 **Function**
Function
combination of soaking, washing, rinsing and spinning light is available

 **Temp.**
Temp.
Press the button to regulate the Hot, warm, cold water for wash.





 **Delay**
Delay
1. Select a program
2. Press the Delay button to choose the time
3. Press [Start/Pause] to commence the delay operation



 →  →  → 
On Choose the Program Setting time Start

Press the [Delay] button until the Delay light is off. It should be pressed before starting the program. If the program already started, should press the [On/Off] button to reset the program.

Caution!

- If there is any break in the power supply while the machine is operating, a special memory stores the selected program and when the power is restarted

 **Speed Wash**
Speed Wash
 →  →  → 
ON/OFF Speed Wash Start The Speed Wash Light

 **Child Lock**
To avoid mis operation by children.
 →  → 
Power on Start Press Child Lock

Caution!

- Press the two buttons also to be released the function.
- The “Child Lock” will lock all buttons except [On/Off].

Operation Instructions

Personalized setting of washing program



Customers can select washing program according to actual demand, and set rinsing times, water volume and appointment time

Operations of washing process

Customers can set single process or combinations of washing, rinsing and spinning freely according to demand. Detailed operations as follows for different models:

One Touch Smart Wash

One touch smart wash is a pre-set program that will run automatically when the user press "ON" then "Start". It's a fully auto controlled program, the sensor will detect the weight of clothing, and run a quick (15mins), a normal (50mins) or a heavy cycle (77mins) accordingly; for this one touch function, only these 3 cycles will be operated.



Spin



Wash + Rinse + Spin

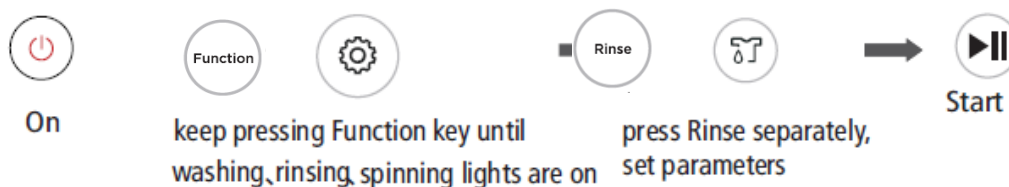

Note!

- Other process combinations are just like above.

Operation Instructions

Washing Program Table

Programs are available according to the laundry type.

Program	
Jeans	Suitable to wash heavy stained/wearable clothes.
Quick 15	Suitable to wash light stained clothes and clothes in summer.
Soft	The tempo is soft, slow washing and spinning speed, to make the lightest wear and deformation.
Mix	Suitable to wash cotton, linen, flax, jute clothes.
Normal (Standard)	Standard fabric washing program, suitable to wash ramie cotton fabric. Wash for once, rinsing for twice, the spin time is a little long.
Strong	The wash time is longer, the stream is stronger, so the washing effect is better.
Heavy	Suitable to wash heavy stained/wearable clothes.
Speed Wash	<p>Start up Speed Wash: Power on, select "Normal", "Soft", "Mix", "Strong", "Jeans" program, then press FCS button, then press "Start/Pause" button, Speed Wash function starts up. The relative figures will be showed after Speed Wash function starts up. Cancellation of Speed Wash function: when the Speed Wash function was selected, The function can be cancelled by pressing Speed Wash button or power off.</p>
Fuzzy Weighting	<p>The washing machine will select the water level automatically according to the load weight.</p> <ol style="list-style-type: none">1. When there's water in the tub, this function is not available;2. Before press [Start/Pause] button, if consumer selected the water level, there will be no fuzzy weighting function;3. After press [Start/Pause] button, the washing machine will run the fuzzy weighting function. Consumer can also select the water level to set the water level as needed.

Cleaning and Care

Warning!

- Before your maintenance starts, please unplug the machine and close the tap.

Cleaning the cabinet

Proper maintenance on the washing machine can extend its working life.

The surface can be cleaned with diluted non-abrasive neutral detergents when necessary. If there is any water overflow, use the wet cloth to wipe it off immediately.

No sharp items are allowed.

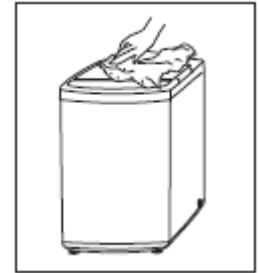

Note!

- Formic acid and its diluted solvents or equivalent are forbidden, such as alcohol, solvents or chemical products, etc.

Cleaning the inlet filter

Note!

- Inlet filter must be cleaned if there is less water.

Washing the filter in washing machine:

1. Screw off the inlet pipe from the backside of the machine.
2. Pull out the filter with long nose pliers and reinstall it back after being washed.
3. Use the brush to clean the filter.
4. Reconnect the inlet pipe.

Lint filter clean

- a. There is a built-in lint filter in your washer. It can help to collect lint during washing cycle.
- b. It is suggested to clean the lint filter every 10 cycles.
- c. Take it out and clean the filter with water. Then place it back into the washer.

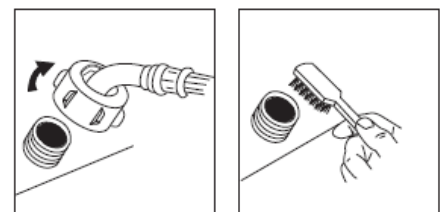

magic filter

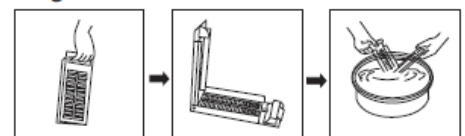

normal filter



Cleaning drain pump filter

Warning

- Be careful of the hot water!
- Allow detergent solution to cool down.
- Unplug the machine to avoid electrical shock before washing.
- Drain pump filter can filter the yarns and small foreign matters from the washing.
- Clean the filter periodically to ensure the normal operation of washing machine.

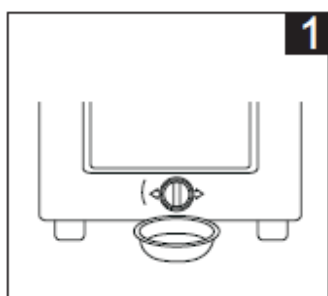

1
Drain the water out of the pump, under which use a container to collect.

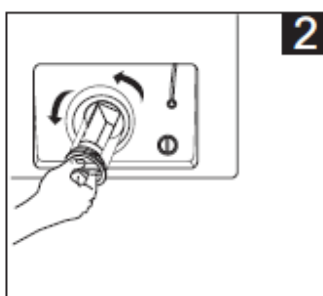

2
Open the filter by turning to the counter clockwise.

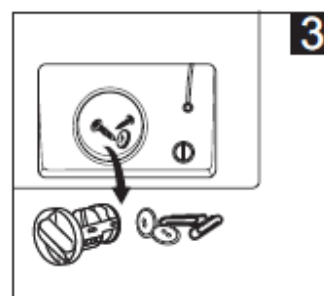

3
Remove extraneous matter

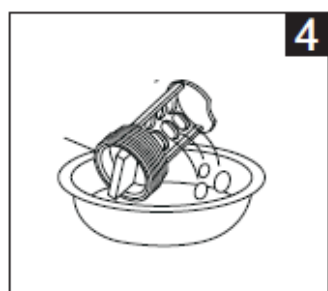

4
Clean the filter

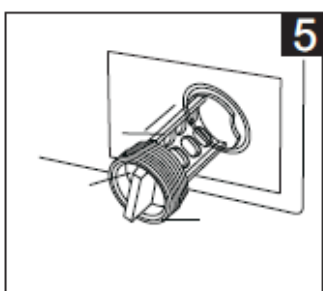

5
Restore it and adjust the convex place to align at the pump hole.

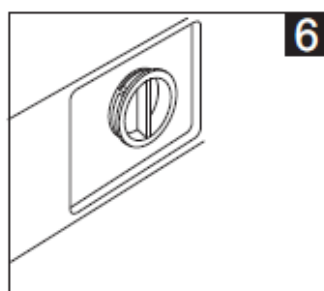

6
Tighten the pump cover clockwise.

Caution!

- Make sure that valve cap and emergency drain hose are reinstalled properly, cap plates should be inserted aligning to hole plates otherwise water may leak;
- Some machines don't have emergency drain hose, so step 2 and step 3 can be skipped. Rotate lower cover cap directly to make water run into basin.
- When the appliance is in use and depending on the program selected there can be hot water in the pump. Never remove the pump cover during a wash cycle, always wait until the appliance has finished the cycle, and is empty. When replacing the cover, ensure it is securely re-tightened.

Troubleshooting

The start of the appliance does not work or it stops during operation. First try to find a solution to the problem, If not, contact the service centre.

Description	Reason
No washing	<p>If the power is off or the fuse is burned out.</p> <p>If the power supply voltage is too low.</p> <p>If the water amount reaches to the required water level.(The washer will not work if the water amount does not reach the required water level) If it is set to "Delay" washing mode. (It will only start to work until the reservation time reached)</p>
No water flows in	<p>If the power is off or the fuse is burned out.</p> <p>If the water supply is cut off or the water pressure is too low.</p> <p>If the inlet hose is properly connected and the water tap is opened.</p> <p>If the filtering screen of inlet valve is blocked by dirt.</p> <p>If the coil of inlet valve is damaged. (The slight electromagnetic sound is normal phenomenon when the inlet valve is switched on)</p> <p>If the "Start / Pause" button is pressed after the power switch is pressed.</p>
Abnormal draining	<p>If the water drain hose is placed very high.</p> <p>If the end of water drain hose is sealed in pond.</p> <p>If the internal rubber ring of drain valve is blocked by dirt.</p>
Abnormal spin	<p>If the door lid is closed.</p> <p>If all clothing piled largely at one side of barrel or the clothing is excessively placed.</p> <p>If the washer is not placed in stable condition or it is placed in inclination state. (The ground is not flat).</p> <p>If the motor belt is loosened.</p>

Description	Reason	Solution
E1	Alarm for abnormal water intaking.	Check the water tap is opened or not.
E2	Alarm for water drain has not finished.	Check the water level sensor and drain pump.
E3	Alarm for lid not closed before wash and spin.	Close the lid, Press "Start" button
E4	Alarm for washing stay at one side.	Manually balance clothes in the barrel by hands.
EXX	Others	Please try again first, call up service line if there are still troubles

Note!

- After the check, activate the appliance. If the problem occurs or the display shows other alarm codes again, contact the service.

Warranty Certificate (New Zealand)

Terms and Conditions

The following conditions apply in respect of the warranty given in this certificate:

1. Monaco Corporation Limited ("Monaco") warrants the following Robinhood products against manufacturing defects and faulty materials, under normal use and subject to the exclusions in this certificate, for a period of:
 - Rangehood, Ovens, Cooktops, Dishwashers, Refrigeration - 24 months from date of original purchase for domestic use.
 - Uniduct - 12 months from date of original purchase for domestic use.
 - Ironing centre - 12 months from date of original purchase for domestic use.
 - Sinks sets- 5 years on stainless steel sink including draining bench from date of original purchase for domestic use, 6 months on all stainless steel accessories, including wire rack, colander and tray from date of original purchase for domestic use.
 - Laundry Tub - 5 years on stainless bowl, 24 months on Tap, Cabinet and other components from the date of original purchase for domestic use.

"Original purchase", when used in this certificate, means purchase by the customer directly from Monaco or one of its approved suppliers.

2. This warranty is limited to the repair or replacement, at our option, within the warranty period of any component part which we at our discretion determine to contain faulty materials or a manufacturing defect in breach of this warranty. This warranty is subject to terms and conditions set out in this certificate.
3. The warranty only applies within New Zealand.
4. The customer must produce the original invoice or other purchase documentation as proof of the original purchase date.

Warranty exclusions

1. The warranty does not apply where, in Monaco's opinion:
 - The defect is caused by misuse, wear and tear, dirt, fire or accidental damage. The product has been repaired or serviced by an unauthorised person.
 - The product was not installed in accordance with our instructions.
 - The product was purchased overseas or was not designed for use in New Zealand. The product was not used, cleaned or cared for in accordance with our instructions.
 - The product was used outdoors.
2. In addition, this warranty does not extend to damage or defects which in our opinion, directly or indirectly arise from or are due to:
 - Exposing the product to acidic or corrosive materials or chemicals such as dyes, solvents, denture cleaner or acetone; Using inappropriate household cleaning products such as abrasive cream or powder cleansers, furniture polish, bleach, mentholated spirits, drain cleaners, sugar soap, metal pads and strongly alkaline or acidic cleaners;
 - Heat damage, including from washing the product at high temperatures;
 - Impact or mishandling the product, including the impact caused by objects scraped along, thrown or dropped on the product surface or excessive weight being placed on the product;
 - Structural or support changes in or affecting the building or the application where the product has been installed;
 - Failure to clean or maintain the product as recommended; or any other causes specified in the product information as being excluded from this warranty.
3. Variations with the colour or gloss within the product or any ageing or fading of colour, shine or gloss level over time are not covered by this warranty. The warranty does not cover visual imperfections or blemishes in the surface and edges of the product that were not brought to your supplier's attention at the time you inspected the product.
4. Costs incurred on installation or removal of a product, or any reinstallation of a product, or any associated costs, are not covered by this warranty.
5. Monaco will not be liable for consequential or indirect loss or damage whatsoever and however arising out of or in connection with the supply, performance or removal of the product, including (but not limited to) loss of profit, loss of revenue, loss of contract, loss of goodwill or increased cost of workings, even if due to the negligence of Monaco or any of its approved suppliers, employees or agents.
6. Charcoal filters and light bulbs are not covered by this warranty
7. This warranty and the statements contained in this certificate or other documents given to you do not exclude, restrict or modify the application of any term implied into this warranty by statute, provided that (to the extent any statutory provision permits Monaco to limit its liability for a breach of an implied condition or warranty) Monaco's liability for such breach is limited to the payment of the cost of replacing the product, repairing the product or acquiring an equivalent product.
8. Subject to clause 5, our obligations under this warranty are limited to those set out in this certificate, and this warranty is expressly instead of all other warranties, express or implied, including any implied warranty of merchantability or fitness for a particular purpose and notwithstanding any course of dealing between the parties or custom and usage in trade to the contrary.

Terms and conditions are subject to change.

Warranty Certificate (Australia)

Terms and Conditions

If you are a consumer under the Australian Consumer Law, our goods come with guarantees that cannot be excluded under the Australian Consumer Law. You are entitled to a replacement or refund for a major failure and for compensation for any other reasonably foreseeable loss or damage. You are also entitled to have the goods repaired or replaced if the goods fail to be of acceptable quality and the failure does not amount to a major failure.

1. Shriro Australia Pty Limited ("Shriro") also warrants the following Robinhood products against manufacturing defects and faulty materials, under normal use and subject to the exclusions in this certificate, for a period of:
 - Rangehood, Ovens, Cooktops, Dishwashers, Refrigeration - 24 months from date of original purchase for domestic use.
 - Uniduct - 12 months from date of original purchase for domestic use.
 - Ironing centre - 12 months from date of original purchase for domestic use.
 - Sinks sets- 5 years on stainless steel sink including draining bench from date of original purchase for domestic use, 6 months on all stainless steel accessories, including wire rack, colander and tray from date of original purchase for domestic use.
 - Laundry Tub - 5 years on stainless bowl, 24 months on Tap, Cabinet and other components from the date of original purchase for domestic use. "Original purchase", when used in this certificate, means purchase by the customer directly from Shriro or one of its approved suppliers.
2. This warranty is limited to the repair or replacement, at our option, within the warranty period of any component part which we at our discretion determine to contain faulty materials or a manufacturing defect in breach of this warranty. This warranty is subject to terms and conditions set out in this certificate.
3. The warranty only applies within Australia.
4. For warranty service outside of capital city metropolitan area or 30 km from nearest authorised service agent you will be liable for reasonable travelling expenses and the cost of transport of the product or parts to and from the service agent
5. To make a claim under this warranty, you must produce the original invoice or other purchase documentation as proof of the original purchase date. You must send your claim to Shriro Australia Pty Limited, 104 Vanessa Street, Kingsgrove, NSW, 2208, within 7 days of any alleged defect or failure of the product first becoming apparent. You are responsible for the expense of making a claim under this warranty.

This warranty is given by:

Shriro Australia Pty Ltd, ABN: 28 002 386 129

Telephone: 1800 648 556

Facsimile: 1800 628 577

Email: customercare@robinhood.com.au

www.robinhood.com.au

Attention: Customer Services Manager

Warranty exclusions

1. The warranty does not apply where, in Shriro's opinion:
 - The defect is caused by misuse, wear and tear, dirt, fire or accidental damage. The product has been repaired or serviced by an unauthorised person.
 - The product was not installed in accordance with our instructions.
 - The product was purchased overseas or was not designed for use in Australia.
 - The product was not used, cleaned or cared for in accordance with our instructions.
 - The product was used outdoors.
2. All Robinhood Rangehoods are suitable for indoor use only and not suitable over BBQs or charcoal cookers designed for outdoor use.
3. In addition, this warranty does not extend to damage or defects which in our opinion, directly or indirectly arise from or are due to: exposing the product to acidic or corrosive materials or chemicals such as dyes, solvents, denture cleaner or acetone; using inappropriate household cleaning products such as abrasive cream or powder cleansers, furniture polish, bleach, mentholated spirits, drain cleaners, sugar soap, metal pads and strongly alkaline or acidic cleaners; heat damage, including from washing the product at high temperatures; impact or mishandling the product, including the impact caused by objects scraped along, thrown or dropped on the product surface or excessive weight being placed on the product; structural or support changes in or affecting the building or the application where the product has been installed; failure to clean or maintain the product as recommended; or any other causes specified in the product information as being excluded from this warranty.
4. Variations with the colour or gloss within the product or any ageing or fading of colour, shine or gloss level over time are not covered by this warranty. The warranty does not cover visual imperfections or blemishes in the surface and edges of the product that were not brought to your supplier's attention at the time you inspected the product.
5. We will not be responsible under this warranty for, nor pay the costs of, removing the existing product, or reinstalling the new product, or any associated costs or damages.
6. Charcoal filters and light bulbs are not covered by this warranty.

The benefits given by this warranty are in addition to other rights and remedies of consumers under any law in relation to the goods which cannot be excluded.

This warranty certificate is not intended to create a contract between Shriro Australia Pty Limited and the purchaser.

New Zealand
Monaco Corporation Ltd
Telephone: (09) 415 6000
Facsimile: (09) 415 7400
Email: enquiries@robinhood.co.nz
www.robinhood.co.nz

Australia
Shriro Australia Pty Limited
ABN 28 002 386 129
Telephone: 1800 648 556
Facsimile: 1800 628 577
Email: enquiries@robinhood.com.au
www.robinhood.com.au