

Description: **ROBINHOOD DISHWASHER 45CM PAINTED SILVER**

Model Number: **RHDW45PS**



Model RHDW45PS

**Actual unit may vary from model pictured above.*

Contents

Congratulations!

Thank you for choosing one of our appliances. Before you use the appliance, we strongly recommend that you read through the whole user manual which provides important safety instructions and description of the product and the proper use of its functions.

To avoid the ever-present risks involved with using an electrical appliance it is vital that the appliance is installed correctly and that you read the safety instructions carefully to avoid misuse and hazards. It is important that you retain these instructions and your proof of purchase along with any other important documents about this product for future reference.

Due to continual product development, Robinhood reserves the right to alter specifications or appearances without notice.

Content

Important Safety Instructions	1
Product Details	2
Installation Instructions	3
Operating Instructions.....	6
Troubleshooting	20
Cleaning and Maintenance	24
Warranty Certificate (New Zealand).....	26

Disposal Information

- Most of the packing materials are recyclable. Please dispose of these materials through your local recycling depot or by placing them in appropriate collection containers.
- If you wish to discard this product, please contact your local authorities and ask for the correct method of disposal.

Important Safety Instructions

IMPORTANT: Read the assembly instruction section and safety precautions of this booklet carefully before removing the contents of this carton.

1. This appliance is intended to be used in household and similar applications , such as:
 - a. staff kitchen areas in shops, offices and other working environments.
 - b. farmhouses.
 - c. by clients in hotels, motels and other residential type environments.
 - d. bed and breakfast type environments.
2. The appliance is not to be used by persons (including children) with reduced Physical, sensory or mental capabilities, or lack of experience and knowledge, unless they have been given supervision or instruction. Children being supervised not to play with the appliance.
3. The door is not left in the open position since this could present a tripping hazard.
4. When loading items to be washed:
 - a. Locate sharp items so that they are not likely to damage the door seal.
 - b. **WARNING:** Knives and other utensils with sharp points must be loaded in the basket with their points facing down or placed in a horizontal position.
5. If the supply cord is damaged, it must be replaced by the manufacturer or its service agent or a similarly qualified person in order to avoid a hazard.
6. After having installed the appliance, the switched outlet must always be in an accessible position.
7. **WARNING:** Some dishwasher detergents are strongly alkaline. They can be extremely dangerous if swallowed. Avoid contact with the skin and eyes and keep children away from the dishwasher when the door is open. Check that the detergent receptacle is empty after completion on the wash cycle.
8. Do not place any heavy objects on or stand on the door when it is open. The appliance could tip forward.
9. Check that the detergent powder is empty after completion of the wash cycle.
10. Use only detergent and rinse additives designed for automatic dishwasher.
11. Do not operate your dishwasher unless all enclosure panels are properly in place.
12. Never use soap, laundry detergent, or hand washing detergent in your dishwasher.
13. The appliance is to be connected to the water mains using new hose sets and that old hose-sets should not be reused.
14. During installation, the power supply cord must not be excessively or dangerously bent or flattened.
15. The maximum number of place inlet water pressure is 1 MPa.
16. The maximum permissible inlet water pressure is 1 MPa.
17. The minimum permissible inlet water pressure is 0.04 MPa.
18. The openings must not be obstructed by a carpet.

This appliance is for indoor use only, for household use only. To protect against the risk of electrical shock, do not immerse the unit, cord or plug in water or other liquid.

Please unplug before cleaning and maintenance the appliance. Use a soft cloth moisten with mild soap, and then use a dry cloth to wipe it again.

Product Details

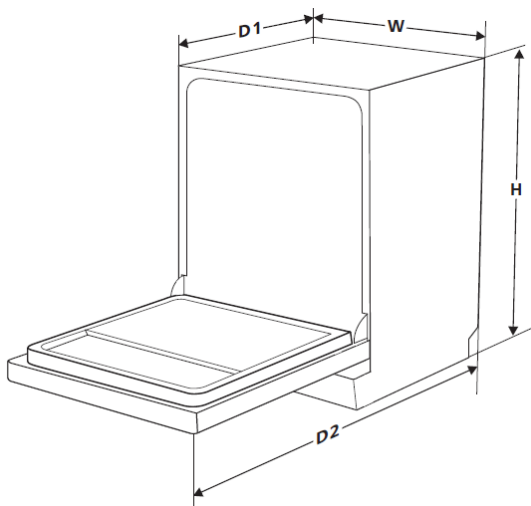

Height:	845 mm
Width:	448 mm
Depth (D1):	600 mm (with the door closed)
Depth (D2):	1150 mm (with door opened 90°)
Water pressure:	0.04-1.0MPa
Power supply:	see rating label
Capacity:	9 place settings

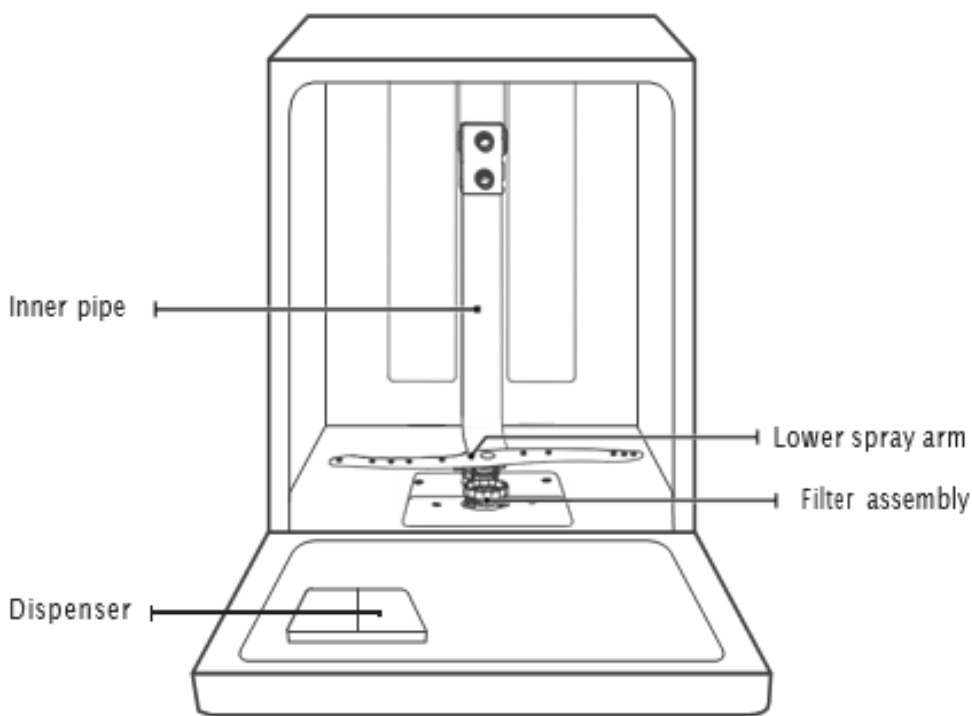

Cutlery basket

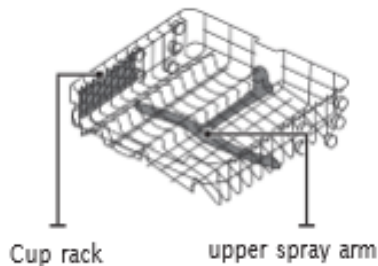

Cup rack upper spray arm
Upper basket



Lower basket

NOTE:

Pictures are only for reference, different models may be different. Please prevail in kind.

Installation Instructions

Electrical Connection

⚠ WARNING

For personal safety:

- Do not use an extension cord or an adapter plug with this appliance.
- Do not, under any circumstances, cut or remove the earthing connection from the power cord.

Please look at the rating label to know the rating voltage and connect the dishwasher to the appropriate power supply. Use the required fuse 10-amp, time delay fuse or circuit breaker recommended and provide separate circuit serving only this appliance.

⚠ Insure proper ground exists before use!

Ensure the voltage and frequency of the power being corresponds to those on the rating plate. Only insert the plug into an electrical socket which is earthed properly. If the electrical socket to which the appliance must be connected is not appropriate for the plug , replace the socket, rather than using an adaptor or the like as they could cause overheating and burns.

This appliance must be earthed. In the event of a malfunction or breakdown, earthing will reduce the risk of electric shock by providing a path of least resistance for the electric current. This appliance is equipped with a cord having an equipment-earthing conductor and an earthing plug. The plug must be plugged into an appropriate outlet that is installed and earthed in accordance with all local standards and requirements.

NOTE: After having installed the appliance, the switched outlet must always be in an accessible position.

⚠ WARNING!

- Improper connection of the equipment earthing conductor can result in the risk of an electric shock.
- Check with a qualified electrician or service representative if you are in doubt whether the appliance is properly earthed.
- Do not modify the plug provided with the appliance. If the plug does not fit properly to the outlet, please have a qualified electrician to install a proper outlet.

Water Supply and Drain

Cold water connection

Connect the cold water supply hose to a threaded 3/4 inch connector and make sure that it is fastened tightly in place. If the water pipes are new or have not been used for an extended period of time, let the water run to make sure that the water is clear. This precaution is needed to avoid the risk of the water inlet to be blocked and damage the appliance.

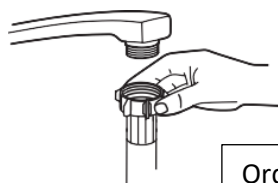

Ordinary supply hose



safety supply hose

Installation Instructions

About the safety supply hose

The safety supply hose consists of the double walls. The hose's system guarantees its intervention by blocking the flow of water in case of the supply hose breaking and when the air space between the supply hose itself and the outer corrugated hose is full of water.

⚠ WARNING

A hose that attaches to a sink spray can burst if it is installed on the same water line as the dishwasher. If your sink has one, it is recommended that the hose be disconnected and the hole plugged.

How to connect the safety supply hose

1. Pull The safety supply hoses completely out from storage compartment located at rear of dishwasher.
2. Tighter the screws of the safety supply hose to the faucet with thread 3/4 inch.
3. Turn water fully on before starting the dishwasher.

How to disconnect the safety supply hose

1. Turn off the water.
2. Unscrew the safety supply hose from the faucet.

Connection Of Drain Hoses

Insert the drain hose into a drain pipe with a minimum diameter of 4 cm, or let it run into the sink, making sure to avoid bending or crimping it. The height of drain pipe must be less than 1000mm. The free end of the hose must not be immersed in water to avoid the back flow of it.

⚠ Please securely fix the drain hose in either position A or position B

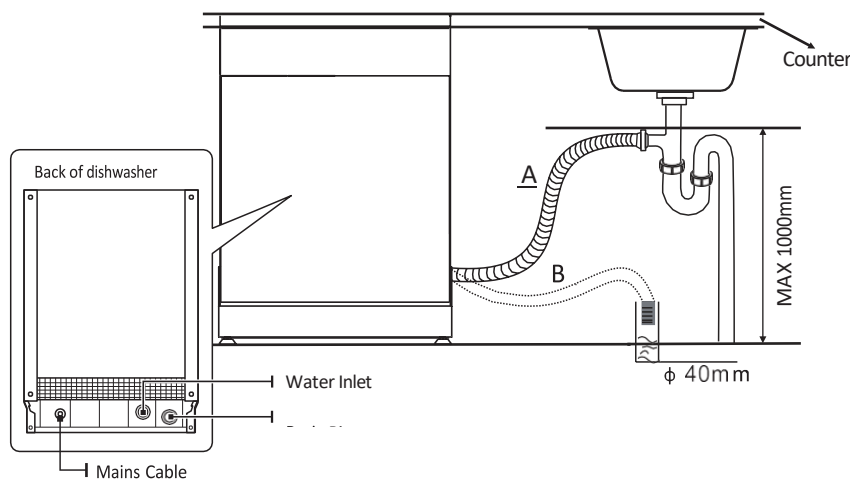

How to drain excess water from hoses

If the sink is 1000 higher from the floor, the excess water in hoses cannot be drained directly into the sink. It will be necessary to drain excess water from hoses into a bowl or suitable container that is held outside and lower than the sink.

Installation Instructions

Water outlet

Connect the water drain hose. The drain hose must be correctly fitted to avoid water leaks. Ensure that the water drain hose is not kinked or squashed.

Extension hose

If you need a drain hose extension, make sure to use a similar drain hose. It must be no longer than 4 meters; otherwise the cleaning effect of the dishwasher could be reduced.

Syphon connection

The waste connection must be at a height less than 100 cm (maximum) from the bottom of the dish. The water drain hose should be fixed.

Positioning The Appliance

Position the appliance in the desired location. The back should rest against the wall behind it, and the sides, along the adjacent cabinets or walls. The dishwasher is equipped with water supply and drain hoses that can be positioned either to the right or the left sides to facilitate proper installation.

Levelling the dishwasher

Dishwasher must be level for proper dish rack operation and wash performance.

1. Place a spirit level on door and rack track inside the tub as shown to check that the dishwasher is level.
2. Level the dishwasher by adjusting the three levelling legs individually.
3. When level the dishwasher, please pay attention not to let the dishwasher tip over.

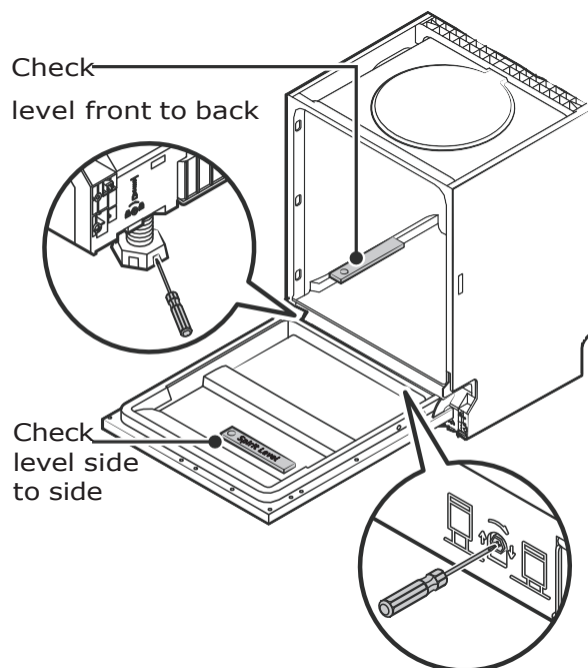

NOTE:

The maximum adjustment height of the feet is 50 mm.

QUICK USER GUIDE

Please read the corresponding content on the instruction manual for detailed operating method.

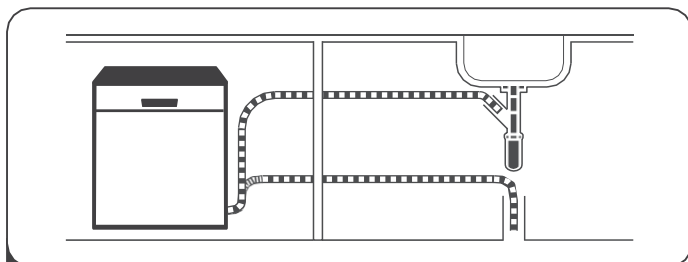

1. Install the dishwasher.



2. Removing the larger residue on the cutlery.

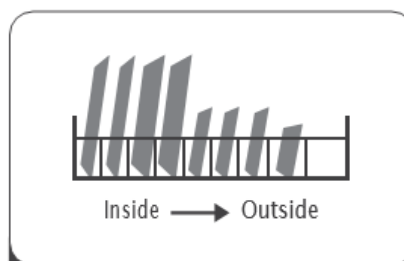

3. Loading the baskets.

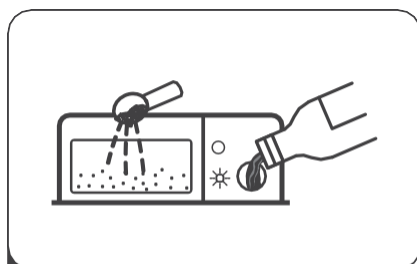

4. Filling the dispenser

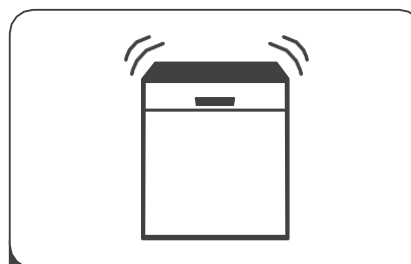

5. Selecting a program and running the dishwasher.

Operating Instructions

USING YOUR DISHWASHER

Before using your dishwasher:

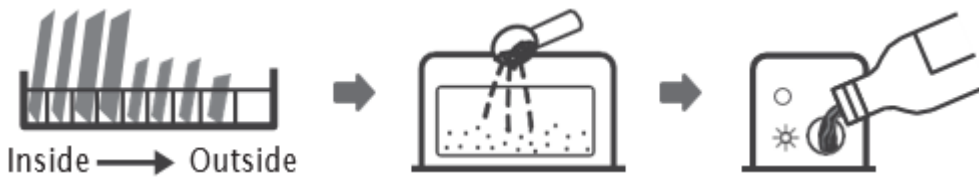

1. Fill the rinse aid dispenser.
2. Fill in detergent.

Basket Used Tips

Adjusting the upper basket

Type 1:

The height of the upper basket can be easily adjusted to accommodate taller dishes in either the upper or lower basket.

To adjust the height of the upper rack, follow these steps:

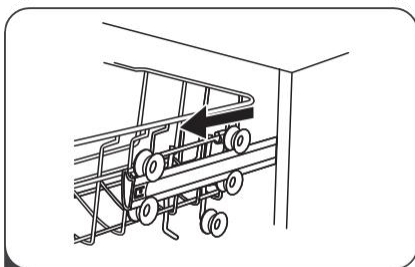

1. Pull out the upper basket.

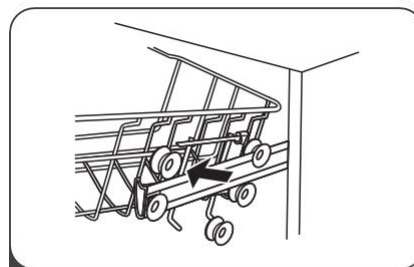

2. Remove the upper basket.

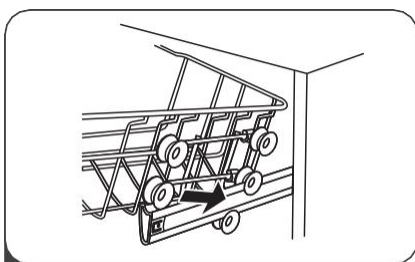

3. Re-attach the upper basket to upper or lower rollers.

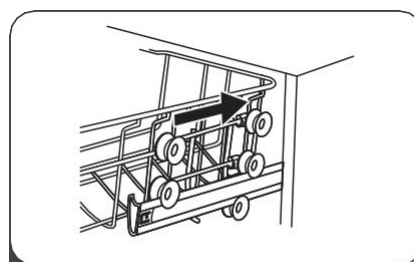

4. Push in the upper basket.

Operating Instructions

Type 2:

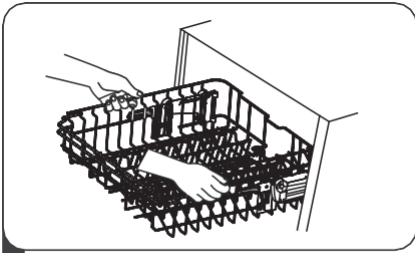

1. To raise the upper basket, just lift the upper basket at the center of each side until the basket locks into place in the upper position. It is not necessary to lift the adjuster handle.

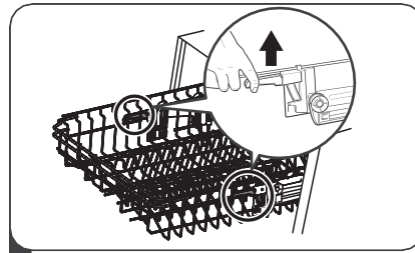

2. To lower the upper basket, lift the adjust handles on each side to release the basket and lower it to the lower position.

Folding back the cup shelves

To make room for taller items in the upper basket, raise the cup rack upwards. You can then lean the tall glasses against it. You can also remove it when it is not required for use.

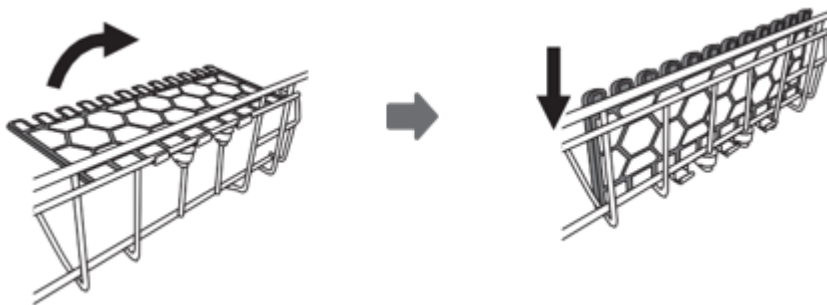

Folding back the rack shelves

The spikes of the lower basket are used for holding plates and a platter. They can be lowered to make more room for large items.

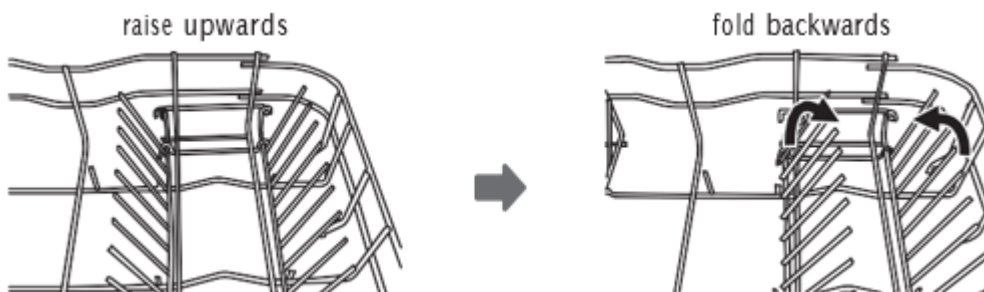

Control Panel

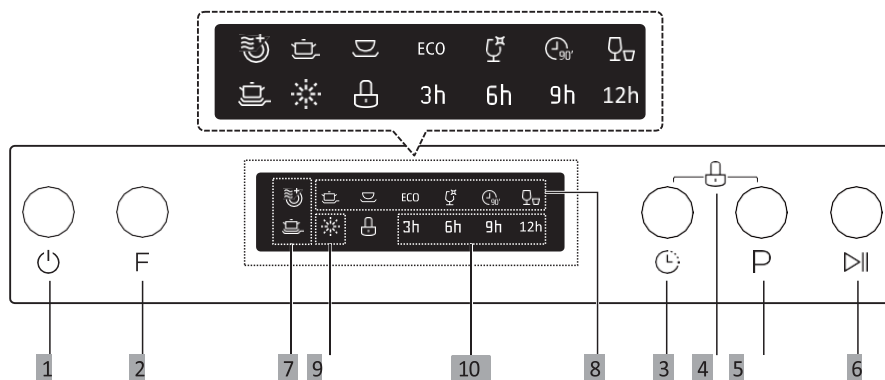









Operation (Button)

1 Power	Press this button to turn on your dishwasher, the screen lights up.
2 Function	Press the button to select a function, corresponding indicator will be lit.
3 Delay	Press the button to set the delay time. When pressing this button, corresponding indicator will be lit.
4 Child Lock	This option allows you to lock the buttons on the control panel - except the Power button - so children cannot accidentally start the dishwasher by pressing the buttons on the panel. To lock or unlock the buttons on the control panel, press and hold the Delay button + Program button for 3 seconds simultaneously. When pressing this button, corresponding indicator will be lit.
5 Program	Select the appropriate washing program, the selected program indicator will be lit.
6 Start / Pause	To start the selected washing program or pause it when the dishwasher is working.

Operating Instructions

Display (Indicator)

<p>7 Function indicator</p>	<p> Extra Drying To wash very dirty, hard to clean dishes. (It can only be used with Intensive, Heavy, ECO, Glass, 90mins.)</p> <p> Power Wash To dry dishes more completely. (It can only be used with Intensive, Heavy, ECO, Glass, 90mins.)</p>
<p>8 Program indicator</p>	<p> Intensive For heaviest soiled crockery, such as pots, pans, casserole dishes and dishes that have been sitting with dried food on them for a while.</p> <p> Heavy For heavily soiled loads, such as pots, plates, glasses and lightly soiled pans.</p> <p>ECO ECO For normally soiled loads, such as pots, plates, glasses and lightly soiled pans. standard daily cycle.</p> <p> Glass For lightly soiled crockery and glass.</p> <p> 90 Min For lightly soiled plates and pans that need quick wash.</p> <p> Rapid A shorter wash for lightly soiled loads that do not need drying.</p>
<p>9 Warning indicator</p>	<p> Rinse Aid If the "  " indicator is lit, it means the dishwasher is low on dishwasher rinse aid and requires a refill.</p>
<p>10 Delay time</p>	<p>To show the delay time(3h/6h/9h/12h).</p>

• Preparing And Loading Dishes

- Consider buying utensils which are identified as dishwasher-proof.
- For particular items, select a program with the lowest possible temperature. To prevent damage, do not take glass and cutlery out of the dishwasher immediately after the program has ended.

For washing the following cutlery/dishes

Are not suitable

- Cutlery with wooden, horn china or mother-of-pearl handles Plastic items that are not heat resistant
- Older cutlery with glued parts that are not temperature resistant Bonded cutlery items or dishes
- Pewter or cooper items Crystal glass
- Steel items subject to rusting Wooden platters
- Items made from synthetic fibres

Are of limited suitability

- Some types of glasses can become dull after a large number of washes Silver and aluminum parts have a tendency to discolour during washing Glazed patterns may fade if machine washed frequently
-

Recommendations for loading the dishwasher

Scrape off any large amounts of leftover food. Soften remnants of burnt food in pans. It is not necessary to rinse the dishes under running water.

For best performance of the dishwasher, follow these loading guidelines. (Features and appearance of baskets and cutlery baskets may vary from your model.)

Place objects in the dishwasher in following way:

- Items such as cups, glasses, pots/pans, etc. are faced downwards.
- Curved items, or ones with recesses, should be loaded aslant so that water can run off.
- All utensils are stacked securely and can not tip over.
- All utensils are placed in the way that the spray arms can rotate freely during washing.

Operating Instructions

Recommendations for loading the dishwasher

- Load hollow items such as cups, glasses, pans etc. With the opening facing downwards so that water cannot collect in the container or a deep base.
- Dishes and items of cutlery must not lie inside one another, or cover each other. To avoid damage, glasses should not touch one another.
- The upper basket is designed to hold more delicate and lighter dishware such as glasses, coffee and tea cups.
- Long bladed knives stored in an upright position are a potential hazard!
- Long and / or sharp items of cutlery such as carving knives must be positioned horizontally in the upper basket.
- Please do not overload your dishwasher. This is important for good results and for reasonable consumption of energy.



NOTE:

Very small items should not be washed in the dishwasher as they could easily fall out of the basket.

Removing the dishes

To prevent water dripping from the upper basket into the lower basket, we recommend that you empty the lower basket first, followed by the upper basket.

⚠ WARNING



Items will be hot! To prevent damage, do not take glass and cutlery out of the dishwasher for around 15 minutes after the program has ended.

Loading the upper basket

The upper basket is designed to hold more delicate and lighter dishware such as glasses, coffee and tea cups and saucers, as well as plates, small bowls and shallow pans (as long as they are not too dirty). Position the dishes and cookware so that they will not get moved by the spray of water.



Loading the lower basket

We suggest that you place large items and the most difficult to clean items are to be placed into the lower basket: such as pots, pans, lids, serving dishes and bowls, as shown in the figure below. It is preferable to place serving dishes and lids on the side of the racks in order to avoid blocking the rotation of the top spray arm. The maximum diameter advised for plates in front of the detergent dispenser is of 19 cm, this not to hamper the opening of it.

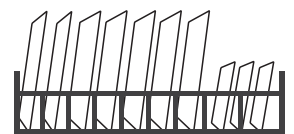

Operating Instructions

Loading the cutlery basket

Cutlery should be placed in the cutlery rack separately from each other in the appropriate positions, and do make sure the utensils do not nest together, this may cause bad performance.

⚠ WARNING

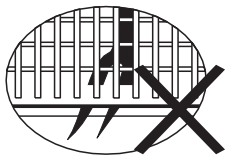

Do not let any item extend through the bottom.

Always load sharp utensils with the sharp point down!

Function Of The Rinse Aid And Detergent

The rinse aid is released during the final rinse to prevent water from forming droplets on your dishes, which can leave spots and streaks. It also improves drying by allowing water to roll off the dishes. Your dishwasher is designed to use liquid rinse aids.

⚠ WARNING

Only use branded rinse aid for dishwasher. Never fill the rinse aid dispenser with any other substances (e.g. Dishwasher cleaning agent, liquid detergent). This would damage the appliance.

When to refill the rinse aid dispenser

Unless the rinse-aid warning light () on the control panel is on, you can always estimate the amount from the color of the optical level indicator located next to the cap. When the rinse-aid container is full, the indicator will be fully dark. The size of the dark dot decreases as the rinse-aid diminishes. You should never let the rinse aid level be less than 1/4 full.

As the rinse aid diminishes, the size of the black dot on the rinse aid level indicator changes, as illustrated below.

● Full ● 3/4 full ● 1/2 full ● 1/4 full ○ Empty

Function of detergent

The chemical ingredients that compose the detergent are necessary to remove, crush and dispense all dirt out of the dishwasher. Most of the commercial quality detergents are suitable for this purpose.

⚠ WARNING

- Proper Use of Detergent

Use only detergent specifically made for dishwashers use. Keep your detergent fresh and dry.

Don't put powdered detergent into the dispenser until you are ready to wash dishes.



Dishwasher detergent is corrosive! Keep dishwasher detergent out of the reach of children.

Operating Instructions

Filling The Rinse Aid Reservoir

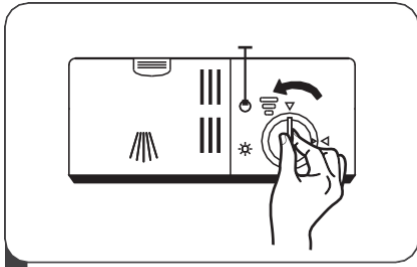

1. To open the dispenser, turn the cap to the "open" (left) arrow and lift it out.

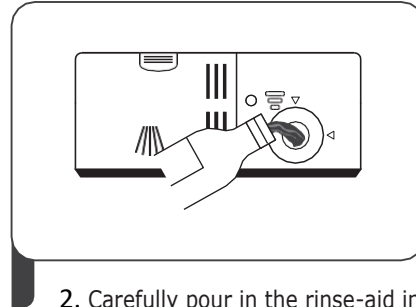

2. Carefully pour in the rinse-aid into its dispenser, whilst avoiding it to overflow.

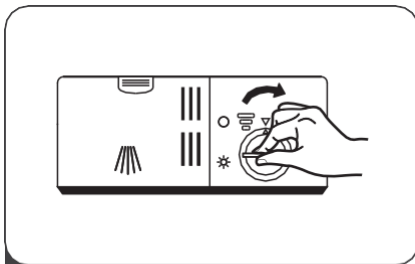

3. Replace the cap by inserting it aligned with "open" arrow and turning it to the closed (right) arrow.

NOTE:

Clean up any spilled rinse aid with an absorbent cloth to avoid excessive foaming during the next wash.

Adjusting the rinse aid reservoir

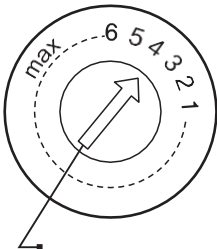

The rinse aid reservoir has six settings. Both the recommended setting and the factory setting is "4". If the dishes are not drying properly or are spotted, adjust the dial to the next higher number until your dishes are spot-free. Reduce it if there are sticky whitish stains on your dishes or a bluish film on glassware or knife blades.

Operating Instructions

Filling The Rinse Aid Reservoir

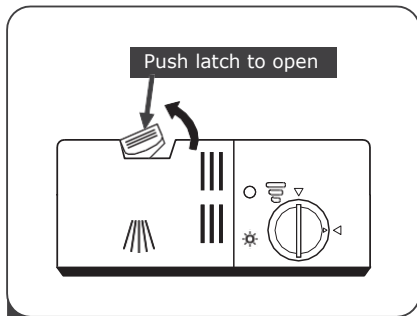

1. Press the release catch on the detergent dispenser to open the cover.

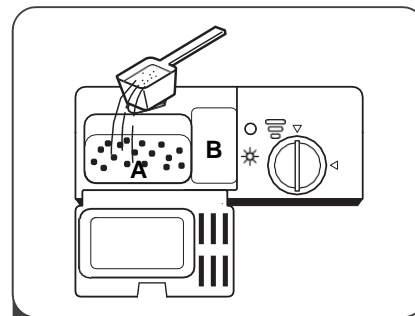

2. Add detergent into the larger cavity (A) for the main wash cycle. For more heavily soiled wash loads, also add some detergent into the smaller cavity (B) for the pre-wash cycle.

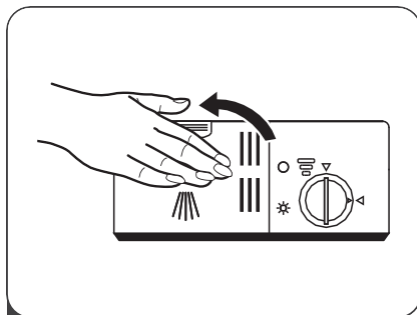

3. Close the cover and press on it until it locks into place.

NOTE:





- Be aware that depending on the soiling of water, setting may be different.
- Please observe the manufacturer's recommendations on the detergent packaging.

Operating Instructions

Wash Cycle Table

The table below shows which programs are best for the levels of food residue on them and how much detergent is needed. It also shows various information about the programs.

(●) Means: need to fill rinse into the Rinse-Aid Dispenser.

Program	Description Of Cycle	Detergent Pre/Main	Running Time(min)	Energy (kWh)	Water (L)	Rinse Aid
 Intensive	Pre-wash(50°C) Wash(60°C) Rinse Rinse Rinse(70°C) Drying	$\frac{5}{21.25g}$ (Or All in 1)	165	1.4	16.5	●
 Heavy	Pre-wash(45°C) Wash (55°C) Rinse Rinse(65°C) Drying	$\frac{5}{21.25g}$ (Or All in 1)	175	1.1	13	●
ECO (*AS/NZS 2007.1)	Pre-wash Wash(45°C) Rinse(45°C) Drying	$\frac{5}{21.25g}$ (Or All in 1)	175	0.55	11.2	●
 Glass	Pre-wash Wash(40°C) Rinse Rinse(60°C) Drying	$\frac{5}{21.25g}$ (Or All in 1)	125	0.75	13.5	●
 90 Min	Wash(65°C) Rinse Rinse(65°C) Drying	$\frac{26.25g}{}$ (Or All in 1)	90	1.15	11.5	●
 Rapid	Wash(45°C) Rinse(50°C) Rinse(55°C)	20g	30	0.7	10	○

 NOTE:

AS/NZS2007.1: This program is the test cycle. The information for comparability test in accordance with AS/NZS2007.1.

Operating Instructions

Starting A Cycle Wash

1. Draw out the lower and upper basket, load the dishes and push them back. It is commended to load the lower basket first, then the upper one.
2. Pour in the detergent.
3. Insert the plug into the socket. The power supply refer to last page "Product fiche". Make sure that the water supply is turned on to full pressure.
4. Close the door, press the Power button, to switch on the machine.
5. Choose a program, the response light will turn on. Then press the Start/Pause button, the dishwasher will start its cycle.

Changing The Program Mid-cycle

A wash cycle can only be changed if it has been running for a short time otherwise, the detergent may have already been released and the dishwasher may have already drained the wash water. If this is the case, the dishwasher needs to be reset and the detergent dispenser must be refilled. To reset the dishwasher, follow the instructions below:

1. Press the Start/Pause button to pause the washing.
2. Press Program button for more than 3 seconds - the program will cancel.
3. Press the Program button to select the desired program.
4. Press the Start/Pause button, after 10 seconds, the dishwasher will start.

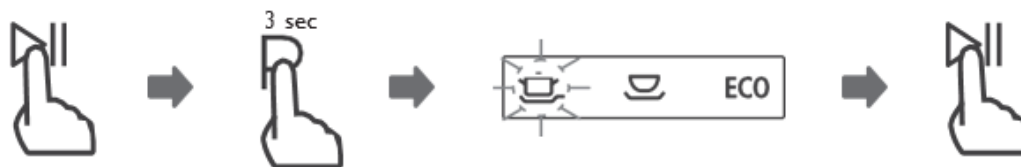

Forget To Add A Dish?

A forgotten dish can be added any time before the detergent dispenser opens. If this is the case, follow the instructions below:

1. Press the Start/Pause button to pause the washing.
2. Wait 5 seconds then open the door.
3. Add the forgotten dishes.
4. Close the door.
5. Press the Start/Pause button after 10 seconds, the dishwasher will start.



⚠ WARNING



It is dangerous to open the door mid-cycle, as hot steam may scald you.

LOADING THE BASKETS ACCORDING TO AS/NZS 2007.1:

1. Upper basket:

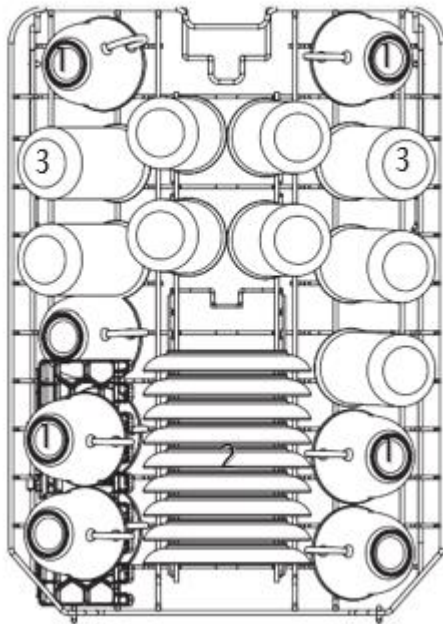

Number	Item
1	Cups
2	Saucers
3	Glasses

2. Lower basket:

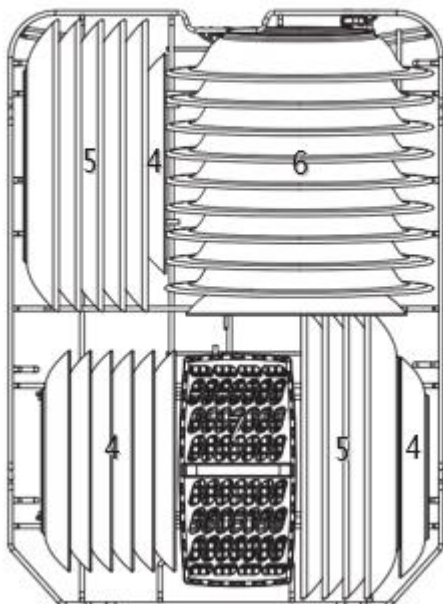

Number	Item
4	Dessert dishes
5	Dinner plates
6	Soup plates
7	Cutlery basket

3. Cutlery basket:

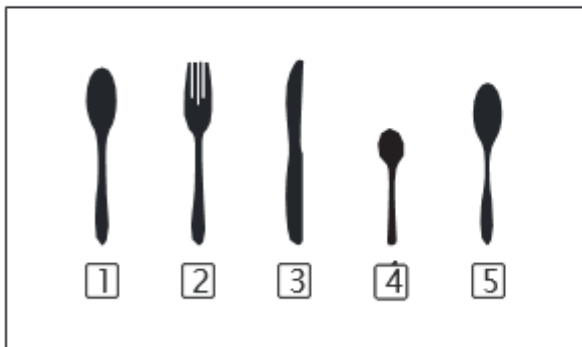
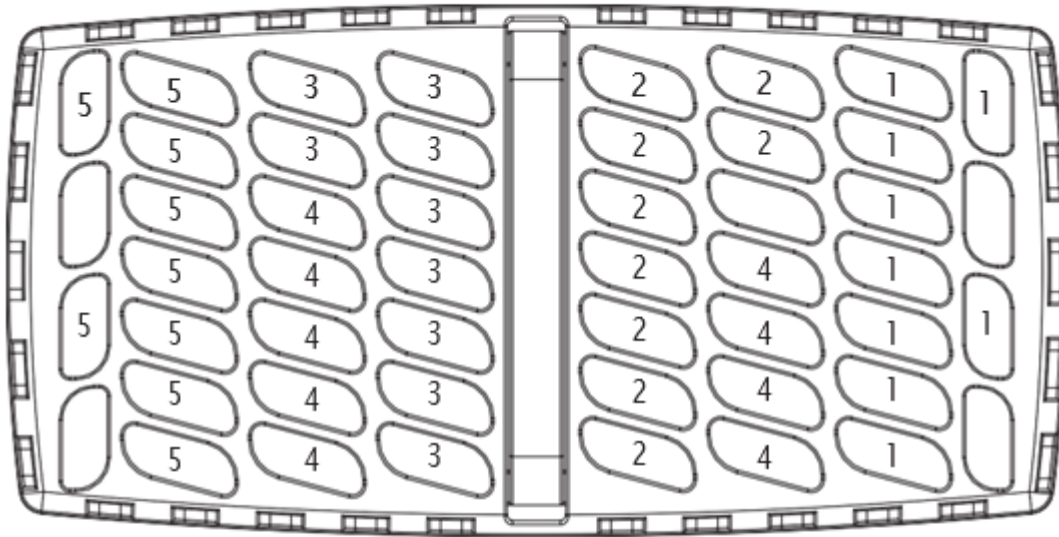

Number	Item
1	Soup spoons
2	Forks
3	Knives
4	Teaspoons
5	Dessert spoons

Information for comparability tests in accordance with (*AS/NZS 2007.1) Capacity: 9 place settings

Position of the upper basket: lower position Program: ECO

Rinse aid setting: 6 Detergent(Pre/main): 5g/21.3g

Door is open at the end of the drying cycle for the drying performance test (Door position: Open 50 mm)

External Care

The door and the door seal

Clean the door seals regularly with a soft damp cloth to remove food deposits.

When the dishwasher is being loaded, food and drink residues may drip onto the sides of the dishwasher door. These surfaces are outside the wash cabinet and are not accessed by water from the spray arms. Any deposits should be wiped off before the door is closed.

The control panel

If cleaning is required, the control panel should be wiped with a soft damp cloth only.

WARNING

- To avoid penetration of water into the door lock and electrical components, do not use a spray cleaner of any kind.
- Never use abrasive cleaners or scouring pads on the outer surfaces because they may scratch the finish. Some paper towels may also scratch or leave marks on the surface.

Internal Care

Filtering system

The filtering system in the base of the wash cabinet retains coarse debris from the washing cycle. The collected coarse debris may cause the filters to clog. Check the condition of the filters regularly and clean them if necessary under running water. Follow the steps below to clean the filters in the wash cabinet.

NOTE:

Pictures are only for reference, different models of the filtering system and spray arms may be different.

Cleaning and Maintenance

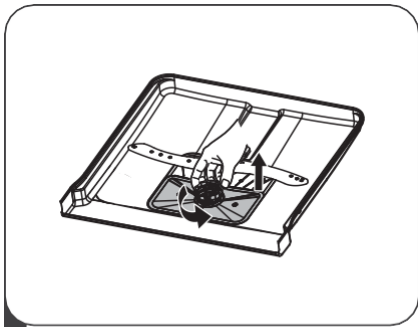

1. Hold the coarse filter and rotate it anticlockwise to unlock the filter. Lift the filter upwards and out of the dishwasher.

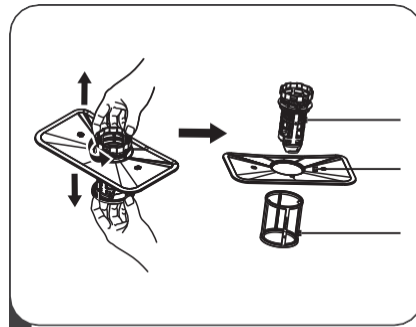

2. The fine filter can be pulled off the bottom of the filter assembly. The coarse filter can be detached from the main filter by gently squeezing the tabs at the top and pulling it away.

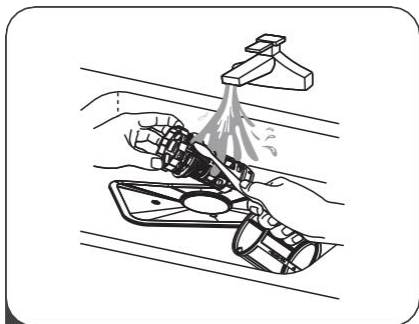

3. Larger food remnants can be cleaned by rinsing the filter under running water. For a more thorough clean, use a soft cleaning brush.

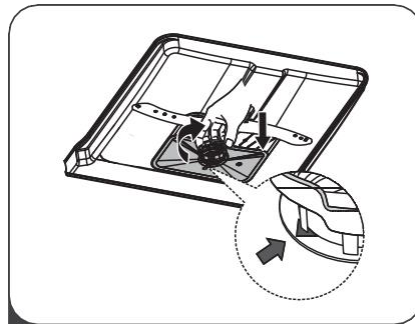

4. Reassemble the filters in the reverse order of the disassembly, replace the filter insert, and rotate clockwise to the close arrow.

WARNING

- Do not over tighten the filters. Put the filters back in sequence securely, otherwise coarse debris could get into the system and cause a blockage.
- Never use the dishwasher without filters in place. Improper replacement of the filter may reduce the performance level of the appliance and damage dishes and utensils.

Cleaning and Maintenance

Spray arms

It is necessary to clean the spray arms regularly for hard water chemicals will clog the spray arm jets and bearings. To clean the spray arms, follow the instructions below:

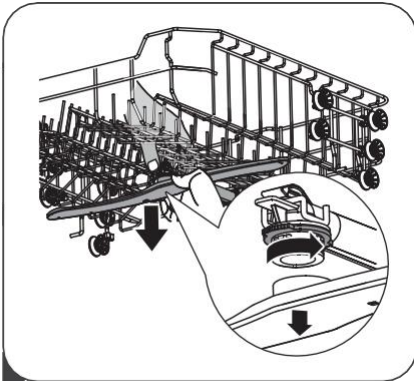

1. To remove the upper spray arm, hold the nut in the center still and rotate the spray arm counterclockwise to remove it.

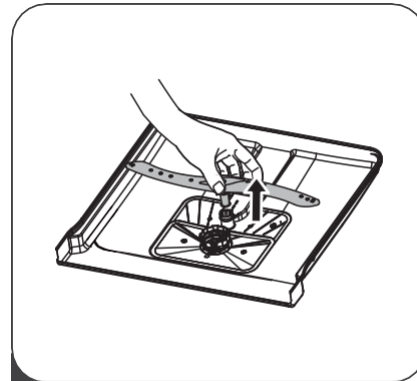

2. To remove the lower spray arm, pull out the spray arm upward.

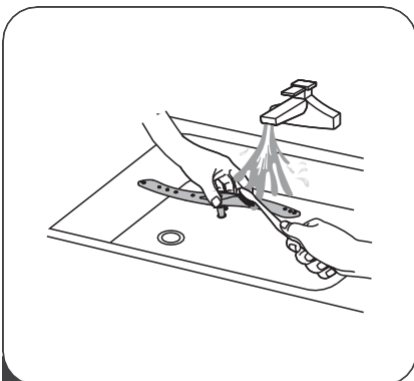

3. Wash the arms in soapy and warm water and use a soft brush to clean the jets. Replace them after rinsing them thoroughly.

Cleaning and Maintenance

Caring For The Dishwasher

Frost precaution

Please take frost protection measures on the dishwasher in winter. Every time after washing cycles, please operate as follows:

1. Cut off the electrical power to the dishwasher at the supply source.
2. Turn off the water supply and disconnect the water inlet pipe from the water valve.
3. Drain the water from the inlet pipe and water valve. (Use a pan to gather the water)
4. Reconnect the water inlet pipe to the water valve.
5. Remove the filter at the bottom of the tub and use a sponge to soak up water in the sump.

After every wash

After every wash, turn off the water supply to the appliance and leave the door slightly open so that moisture and odors are not trapped inside.

Remove the plug

Before cleaning or performing maintenance, always remove the plug from the socket.

No solvents or abrasive cleaning

To clean the exterior and rubber parts of the dishwasher, do not use solvents or abrasive cleaning products. Only use a cloth with warm soapy water.

To remove spots or stains from the surface of the interior, use a cloth dampened with water and a little vinegar, or a cleaning product made specifically for dishwashers.

When not in use for a longtime

It is recommended that you run a wash cycle with the dishwasher empty and then remove the plug from the socket, turn off the water supply and leave the door of the appliance slightly open. This will help the door seals to last longer and prevent odors from forming within the appliance.

Moving the appliance

If the appliance must be moved, try to keep it in the vertical position. If absolutely necessary, it can be positioned on its back.

Seals

One of the factors that cause odours to form in the dishwasher is food that remains trapped in the seals. Periodic cleaning with a damp sponge will prevent this from occurring.

Troubleshooting

Error Codes

When some malfunctions occur, the appliance will display error codes to warn you:

Codes	Meanings	Possible Causes
E1	Longer inlet time.	Faucet is not opened, or water intake is restricted, or water pressure is too low.
E3	Not reaching required temperature	Malfunction of heating element.
E4	Overflow.	Some element of dishwasher leaks.
E8	Failure of orientation of distributary valve	Circuit is open or broken distributary valve.
Ed	Failure of communication between main PCB with display PCB	Open circuit or break wiring for the communication

Warning: If overflow occurs, turn off the main water supply before calling a service. If there is water in the base pan because of an overflow or small leak, the water should be removed before restarting the dishwasher.

Review the chart below for solutions to potential issues.

Problem	Possible Causes	What to Do
Dishwasher doesn't start	Fuse blown, or the circuit breaker tripped	Replace fuse or reset circuit breaker. Remove any other appliances sharing the same circuit with the dishwasher.
	Power supply is not turned on	Make sure the dishwasher is turned on and the door is closed securely. Make sure the power cord is properly plugged into the wall socket.
	Water pressure is low.	Check that the water supply is connected properly and the water is turned on.
	Door of dishwasher not properly closed.	Make sure to close the door properly and latch it.
Water not pumped from dishwasher	Kink in drain hose	Check drain hose.
	Filter clogged	Check the coarse filter.
	Kitchen sink clogged	Check the kitchen sink to make sure it is draining well. If the problem is the kitchen sink not draining, you may need a plumber rather than a serviceman for dishwashers.
Suds in the tub	Improper detergent	Use only the special dishwasher detergent to avoid suds. If this occurred, open the dishwasher and let suds evaporate. Add 1 gallon of cold water to the tub. Close and latch the dishwasher, then select any cycle. Dishwasher will drain out the water at the first step. Open the door after draining is stop and check if the suds is disappeared. Repeat if necessary.
	Spilled rinse-aid	Always wipe up rinse-aid spills immediately.
Stained tub interior	Detergent with colourant was used	Make sure that the detergent is the one without colourant.

Troubleshooting

Problem	Possible Causes	What to Do
White film on inside surface	Hard water minerals	To clean the interior, use a damp sponge with dishwasher detergent and wear rubber gloves. Never use any other cleaner than dishwasher detergent for the risk of foaming or suds.
There are rust stains on cutlery	The affected items are not corrosion resistant	The items should be corrosion resistant.
Knocking noise in the wash cabinet	A spray arm is knocking against an item in a basket	Interrupt the program, and rearrange the items which are obstructing the spray arm.
Rattling noise in the wash cabinet	Items of crockery are loose in the wash cabinet	Interrupt the program and rearrange the items of crockery.
Knocking noise in the water pipes	This may be caused by on-site installation or the cross-section of the piping.	This has no influence on the dishwasher function. if in doubt, contact a suitably qualified plumber.
The dishes are not clean	The dishes were not loaded correctly.	See notes in " Loading the Dishwasher Baskets " .
	The program was not powerful enough.	Select a more intensive program. See" Wash Cycle Table " .
	Not enough detergent was dispensed.	Use more detergent, or change your detergent.
	Items are blocking the path of spray arms	Rearrange the items so that the sprayer can rotate freely.
	The filter combination is not clean or is not correctly fitted. This may cause the spray arm jets get blocked.	Clean and/or fit the filter combination correctly. Clean the spray arm jets. See "Cleaning the Spray Arms" .
Cloudiness on glassware	Combination of soft water and too much detergent.	Use less detergent if you have soft water and select a shortest cycle to wash the glassware and to get them clean.
Black or grey marks on dishes	Aluminium utensils have rubbed against dishes.	Use a mild abrasive cleaner to eliminate those marks.
Detergent left in dispenser cups	Dishes block detergent cup opens.	Re-loading the dishes properly.
The dishes are not drying	Improper loading	Load the dishwasher as suggested in the directions.
	Too little rinse-aid	Increase the amount of rinse-aid/refill the rinse-aid dispenser.
	Dishes are removed too soon	Do not empty your dishwasher immediately after washing. Open the door slightly so that the steam can escape. Begin unloading the dishwasher only once the dishes are barely warm by touching. Empty the low basket first. This prevents water from dropping off dishes in the upper basket.
	Wrong program has been selected	In short program the rinse temperature is lower. This also lowers cleaning performance. Choose a program with a long high rinse temperature.
	Use of cutlery with a low-quality coating	Water drainage is more difficult with these items. Cutlery or dishes of this type are not suitable for washing in the dishwasher.

Warranty Certificate (New Zealand)

Terms and Conditions

The following conditions apply in respect of the warranty given in this certificate:

1. Monaco Corporation Limited ("Monaco") warrants the following Robinhood products against manufacturing defects and faulty materials, under normal use and subject to the exclusions in this certificate, for a period of:
 - Rangehood, Ovens, Cooktops, Dishwashers, Refrigeration - 24 months from date of original purchase for domestic use.
 - Uniduct - 12 months from date of original purchase for domestic use.
 - Ironing centre - 12 months from date of original purchase for domestic use.
 - Sinks sets- 5 years on stainless steel sink including draining bench from date of original purchase for domestic use, 6 months on all stainless steel accessories, including wire rack, colander and tray from date of original purchase for domestic use.
 - Laundry Tub - 5 years on stainless bowl, 24 months on Tap, Cabinet and other components from the date of original purchase for domestic use.

"Original purchase", when used in this certificate, means purchase by the customer directly from Monaco or one of its approved suppliers.

2. This warranty is limited to the repair or replacement, at our option, within the warranty period of any component part which we at our discretion determine to contain faulty materials or a manufacturing defect in breach of this warranty. This warranty is subject to terms and conditions set out in this certificate.
3. The warranty only applies within New Zealand.
4. The customer must produce the original invoice or other purchase documentation as proof of the original purchase date.

Warranty exclusions

1. The warranty does not apply where, in Monaco's opinion:
 - The defect is caused by misuse, wear and tear, dirt, fire or accidental damage. The product has been repaired or serviced by an unauthorised person.
 - The product was not installed in accordance with our instructions.
 - The product was purchased overseas or was not designed for use in New Zealand. The product was not used, cleaned or cared for in accordance with our instructions.
 - The product was used outdoors.
2. In addition, this warranty does not extend to damage or defects which in our opinion, directly or indirectly arise from or are due to:
 - Exposing the product to acidic or corrosive materials or chemicals such as dyes, solvents, denture cleaner or acetone; Using inappropriate household cleaning products such as abrasive cream or powder cleansers, furniture polish, bleach, mentholated spirits, drain cleaners, sugar soap, metal pads and strongly alkaline or acidic cleaners;
 - Heat damage, including from washing the product at high temperatures;
 - Impact or mishandling the product, including the impact caused by objects scraped along, thrown or dropped on the product surface or excessive weight being placed on the product;
 - Structural or support changes in or affecting the building or the application where the product has been installed;
 - Failure to clean or maintain the product as recommended; or any other causes specified in the product information as being excluded from this warranty.
3. Variations with the colour or gloss within the product or any ageing or fading of colour, shine or gloss level over time are not covered by this warranty. The warranty does not cover visual imperfections or blemishes in the surface and edges of the product that were not brought to your supplier's attention at the time you inspected the product.
4. Costs incurred on installation or removal of a product, or any reinstallation of a product, or any associated costs, are not covered by this warranty.
5. Monaco will not be liable for consequential or indirect loss or damage whatsoever and however arising out of or in connection with the supply, performance or removal of the product, including (but not limited to) loss of profit, loss of revenue, loss of contract, loss of goodwill or increased cost of workings, even if due to the negligence of Monaco or any of its approved suppliers, employees or agents.
6. Charcoal filters and light bulbs are not covered by this warranty
7. This warranty and the statements contained in this certificate or other documents given to you do not exclude, restrict or modify the application of any term implied into this warranty by statute, provided that (to the extent any statutory provision permits Monaco to limit its liability for a breach of an implied condition or warranty) Monaco's liability for such breach is limited to the payment of the cost of replacing the product, repairing the product or acquiring an equivalent product.
8. Subject to clause 5, our obligations under this warranty are limited to those set out in this certificate, and this warranty is expressly instead of all other warranties, express or implied, including any implied warranty of merchantability or fitness for a particular purpose and notwithstanding any course of dealing between the parties or custom and usage in trade to the contrary.

Terms and conditions are subject to change.