

Description: **Robinhood 4 Program Freestanding Dishwasher**

Model Numbers: **RHDW4345W, RHDW4345X**



Models Pictured: **RHDW4345W, RHDW4345X**



## **Read this Manual**

Dear Customer,

- Please carefully read this manual before using the dishwasher, it will help you to use and maintain the dishwasher properly.
- Keep it for reference in future.
- Pass it on to any subsequent owner of the appliance.

This manual contains sections on safety Instructions, Operating Instructions, Installation Instructions and Troubleshooting Tips etc.



## **Before Calling for Service**

- To review the section on troubleshooting Tips will help you to solve some common problems by yourself.
- If you cannot solve the problems by yourself, please ask for the help from professional technicians.

# A

## **NOTE:**

The manufacturer, following a policy of constant development and updating of the product, may make modifications without giving prior notice.

Index.....	1
Important Safety Instructions.....	2
Installation Instruction. ....	3-5
Operating Instruction. ....	6-7
Detergent Filling.....	8-10
Basket and Rack Shelves. ....	11-12
Loading.....	13
Wash Program.....	14-15
Maintenance and Cleaning.....	16-20
Trouble Shooting Tips. ....	21-24
Appliance Details.....	25
Disposal. ....	26
Loading the Basket.....	27
Warranty Card. ....	28-29

Loading the baskets according to (\*AS/NZS 2007.1)

## Important Safety Instructions

1. This appliance is intended to be used in household and similar applications , such as:
  - staff kitchen areas in shops, offices and other working environments;
  - farm houses;
  - by clients in hotels, motels and other residential type environments;
  - bed and breakfast type environments.
2. The appliance is not to be used by persons (including children) with reduced Physical, sensory or mental capabilities, or lack of experience and knowledge, unless they have been given supervision or instruction. Children being supervised not to play with the appliance.
3. The door is not left in the open position since this could present a tripping hazard.
4. When loading items to be washed:
  - Locate sharp items so that they are not likely to damage the door seal.
  - WARNING:** Knives and other utensils with sharp points must be loaded in the basket with their points facing down or placed in a horizontal position.
5. If the supply cord is damaged, it must be replaced by the manufacturer or its service agent or a similarly qualified person in order to avoid a hazard.
6. **WARNING:** Some dishwasher detergents are strongly alkaline. They can be extremely dangerous if swallowed. Avoid contact with the skin and eyes and keep children away from the dishwasher when the door is open. Check that the detergent receptacle is empty after completion on the wash cycle.
7. Do not place any heavy objects on or stand on the door when it is open. The appliance could tip forward.
8. Check that the detergent powder is empty after completion of the wash cycle.
9. Use only detergent and rinse additives designed for automatic dishwasher.
10. Do not operate your dishwasher unless all enclosure panels are properly in place.
11. Never use soap, laundry detergent, or hand washing detergent in your dishwasher.
12. The appliance is to be connected to the water mains using new hose sets and that old hose-sets should not be reused.
13. During installation, the power supply cord must not be excessively or dangerously bent or flattened.
13. Maximum 12 place settings.
  - Maximum 1 MPa permissible inlet water pressure.
  - Minimum 0.04 0.04MPa.

This appliance is for indoor use only, for household use only. To protect against the risk of electrical shock, do not immerse the unit, cord or plug in water or other liquid.

Please unplug before cleaning and maintenance the appliance .Use a soft cloth moisten with mild soap, and then use a dry cloth to wipe it again.

## Installation Instruction

### **Electrical Shock Hazard**

Disconnect electrical power before installing dishwasher.  
Failure to do so could result in death or electrical shock.

The installation of the pipes and electrical equipments should be done by professionals.

### **For personal safety:**

Do not use an extension cord or an adapter plug with this appliance.  
Do not, under any circumstances, cut or remove the earthing connection from the power cord.

### **Electrical requirements**

Please look at the rating label to know the rating voltage and connect the dishwasher to the appropriate power supply. Use the required fuse 10A/13A/16A, time delay fuse or circuit breaker recommended and provide separate circuit serving only this appliance.

### **Electrical connection**

Ensure the voltage and frequency of the power being corresponds to those on the rating plate. Only insert the plug into an electrical socket which is earthed properly. If the electrical socket to which the appliance must be connected is not appropriate for the plug, replace the socket, rather than using an adaptors or the like as they could cause overheating and burns.

**WARNING:** Ensure that proper earthing exists before use.

This appliance must be earthed. In the event of a malfunction or breakdown, earthing will reduce the risk of an electric shock by providing a path of least resistance of electric current. This appliance is equipped with a cord having an equipment-earthing conductor and an earthing plug.

The plug must be plugged into an appropriate outlet that is installed and earthed in accordance with all local codes and ordinances.

Improper connection of the equipment-earthing conductor can result in the risk of an electric shock. Check with a qualified electrician or service representative if you are in doubt whether the appliance is properly earthed.

Do not modify the plug provided with the appliance; If it does not fit the outlet. Have a proper outlet installed by a qualified electrician.

# Installation Instruction

## Position the appliance

Position the appliance in the desired location. The back should rest against the wall behind it, and the sides, along the adjacent cabinets or walls. The dishwasher is equipped with water supply and drain hoses that can be positioned either to the right or the left sides to facilitate proper installation.

## Levelling the appliance

Once the appliance is positioned for levelling, the height of the dishwasher may be altered via adjustment of the screwing level of the feet. In any case, the appliance should not be inclined more than 2°.

Note: Only apply to freestanding dishwasher.

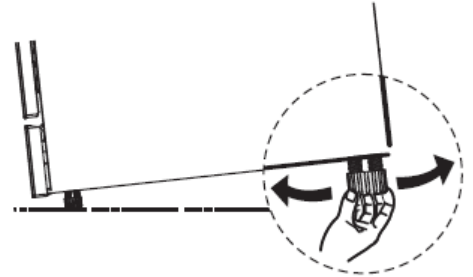

## Water Supply and Drain

### Cold water connection

Connect the cold water supply hose to a threaded 3/4(inch) connector and make sure that it is fastened tightly in place. If the water pipes are new or have not been used for an extended period of time, let the water run to make sure that the water is clear. This precaution is needed to avoid the risk of the water inlet to be blocked and damage the appliance.

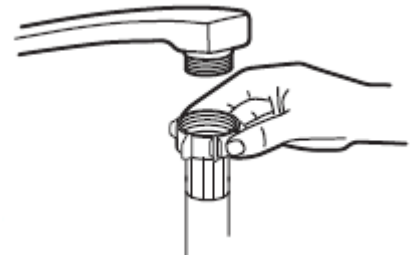

# Installation Instruction

## Connection of Drain Hoses

Insert the drain hose into a drain pipe with a minimum diameter of 4 cm, or let it run into the sink, making sure to avoid bending or crimping it. The height of drain pipe must be less than 1000mm. The free end of the hose must not be immersed in water to avoid the back flow of it.

Please securely fix the drain hose in either position A or position B

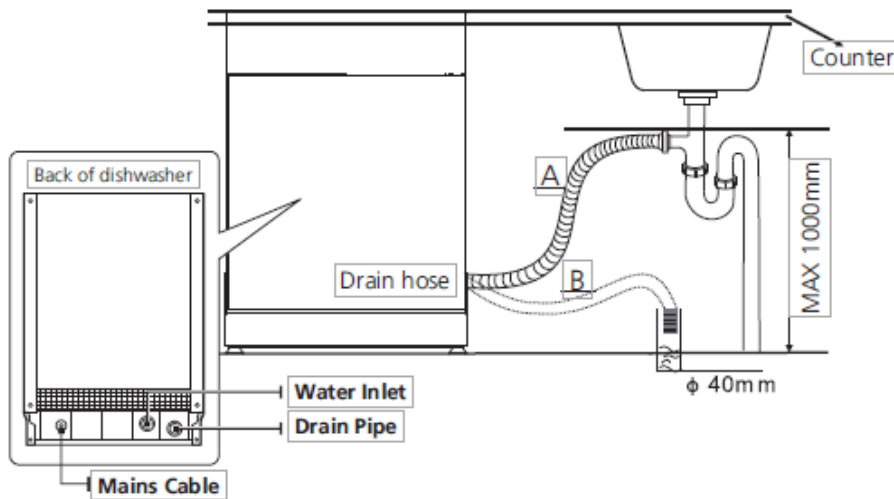

## How to drain excess water from hoses

If the sink is 1000 higher from the floor, the excess water in hoses cannot be drained directly into the sink. It will be necessary to drain excess water from hoses into a bowl or suitable container that is held outside and lower than the sink.

## Water outlet

Connect the water drain hose. The drain hose must be correctly fitted to avoid water leaks. Ensure that the water drain hose is not kinked or squashed.

## Extension hose

If you need a drain hose extension, make sure to use a similar drain hose. It must be no longer than 4 meters; otherwise the cleaning effect of the dishwasher could be reduced.

## Syphon connection

The waste connection must be at a height less than 100 cm (maximum) from the bottom of the dish. The water drain hose should be fixed.

# Operating Instruction



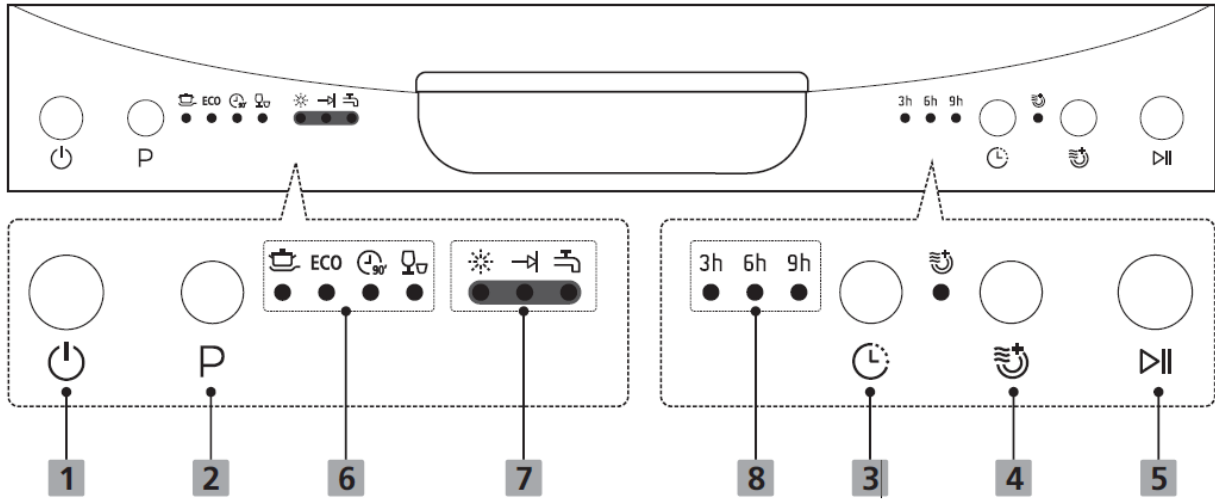



## Control Panel



## Operation (Button)

1 Power	Press this button to turn on your dishwasher, the screen lights up.
2 Program	Select the appropriate washing program, the selected program indicator will be lit.
3 Delay	Press the button to set the delay time, corresponding indicator will be lit.
4 Extra Drying	To dry dishes more completely.(It can only be used with Intensive, ECO and 90 mins.)
5 Start/Pause	To start the selected washing program or pause it when the dishwasher is working.

## Indicator

6 Program indicator		<p>Intensive</p> <p>For heaviest soiled crockery, such as pots, pans, casserole dishes and dishes that have been sitting with dried food on them for some time.</p>
7 Warning indicator	ECO	<p>ECO</p> <p>For normally soiled loads, such as pots, plates, glasses and lightly soiled pans, standard everyday cycle.</p>
		<p>90 mins</p> <p>For lightly soiled plates and pans that need quick wash.</p>
		<p>Rapid</p> <p>A shorter wash for lightly soiled loads that do not need drying.</p>
		<p>Rinse Aid</p> <p>If the " * " indicator is lit, it means the dishwasher is low on dishwasher rinse aid and requires a refill.</p>
		<p>Program end</p> <p>When the program is end, the indicator will be lit.</p>
		<p>Water Faucet</p> <p>If the " ⚡ " indicator is lit, it means the water faucet closed.</p>
8 Delay time	To show the delay time (3h/6h/9h).	



## Function of The Rinse Aid And Detergent

The rinse aid is released during the final rinse to prevent water from forming droplets on your dishes, which can leave spots and streaks. It also improves drying by allowing water to roll off the dishes. Your dishwasher is designed to use liquid rinse aids.

**WARNING:** Only use branded rinse aid for dishwasher. Never fill the rinse aid dispenser with any other substances (e.g. Dishwasher cleaning agent, liquid detergent). This would damage the appliance.

### When to refill the rinse aid dispenser

Unless the rinse-aid warning light ( ✨ ) on the control panel is on, you can always estimate the amount from the color of the optical level indicator located next to the cap.

When the rinse-aid container is full, the indicator will be fully dark. The size of the dark dot decreases as the rinse- aid diminishes. You should never let the rinse aid level be less than 1/4 full.

As the rinse aid diminishes, the size of the black dot on the rinse aid level indicator changes, as illustrated below.

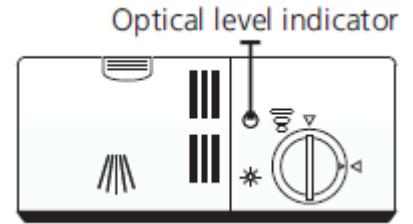

Full

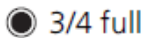

3/4 full

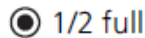

1/2 full

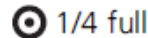

1/4 full

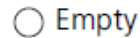

Empty

### **⚠ WARNING**

- Proper Use of Detergent

Use only detergent specifically made for dishwashers use. Keep your detergent fresh and dry.

Don't put powdered detergent into the dispenser until you are ready to wash dishes.



**Dishwasher detergent is corrosive! Keep dishwasher detergent out of the reach of children.**

## Filling The Rinse Aid Reservoir

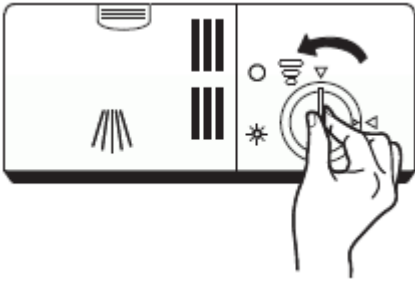

1. Remove the rinse aid reservoir cap by rotating it counterclockwise.



2. Carefully pour in the rinse-aid into its dispenser, whilst avoiding it to overflow.

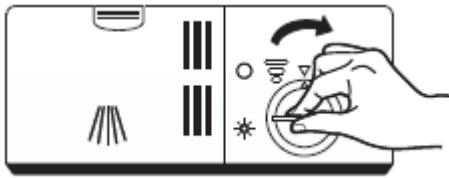

3. Close the rinse aid reservoir cap by rotating it clockwise.

### NOTE:

Clean up any spilled rinse aid with an absorbent cloth to avoid excessive foaming during the next wash.

## Adjusting the rinse aid reservoir

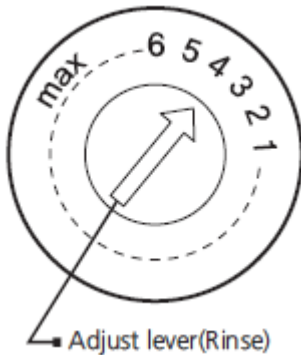

## Filling The Detergent Dispenser

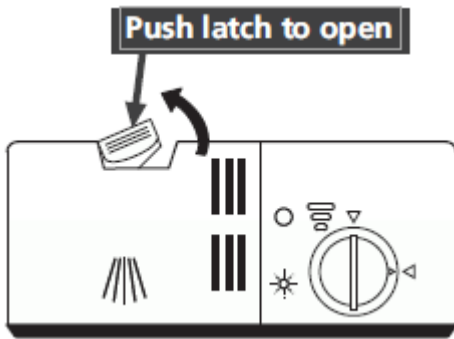

1. Press the release catch on the detergent 2 dispenser to open the cover.

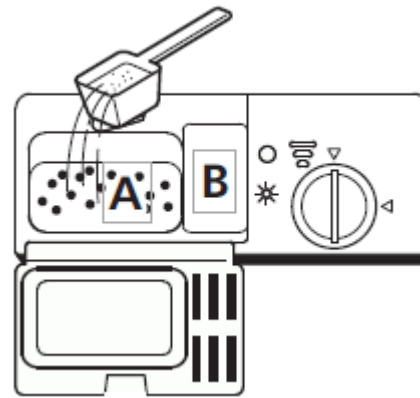

2. Add detergent into the larger cavity (A) for the main wash cycle.

For more heavily soiled wash loads, also add some detergent into the smaller cavity (B) for the pre-wash cycle .

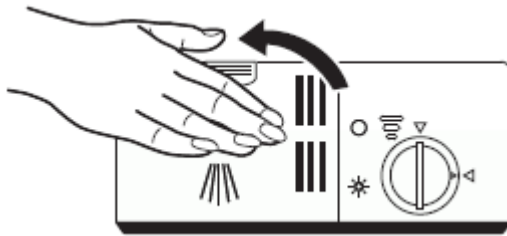

3. Close the cover and press on it until it locks into place.

### NOTE:

Be aware that depending on the soiling of water, setting may be different. Please observe the manufacturer's recommendations on the detergent packaging.

## Basket Used Tips

### Adjusting the upper basket

The height of the upper basket can be easily adjusted to accommodate taller dishes in either the upper or lower basket.

To adjust the height of the upper rack, follow these steps:

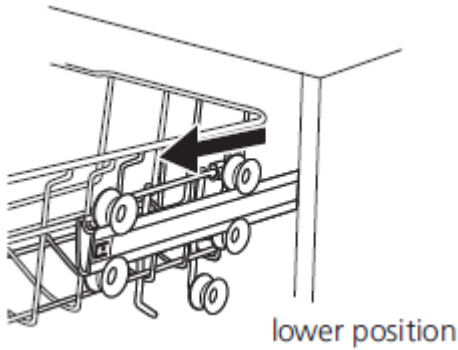

1. Pull out the upper basket.

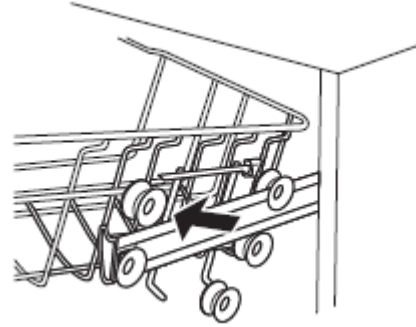

2. Remove the upper basket.

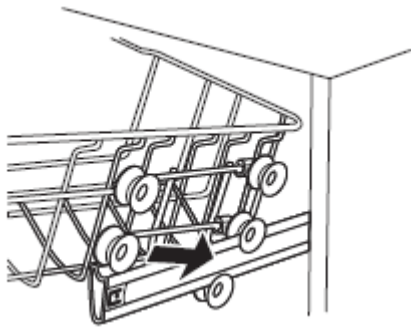

3. Re-attach the upper basket to upper or lower rollers.

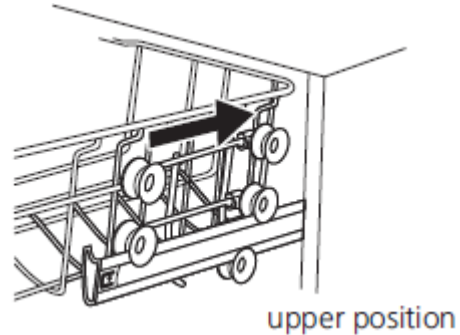

4. Push in the upper basket

### Folding back the cup shelves

To make room for taller items in the upper basket, raise the cup rack upwards. You can then lean the tall glasses against it. You can also remove it when it is not required for use.

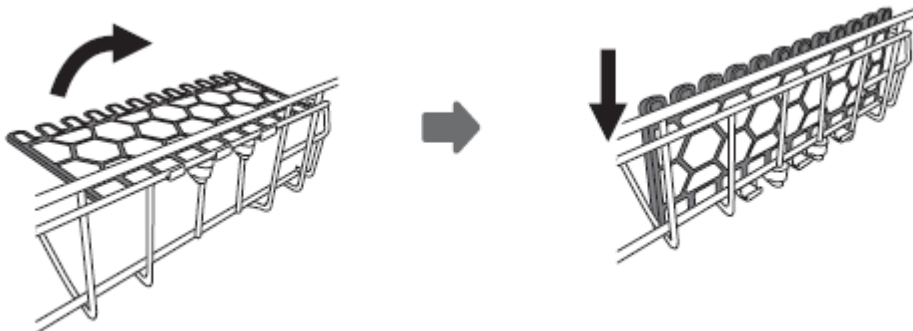

## Folding back the rack shelves

The spikes of the lower basket are used for holding plates and a platter. They can be lowered to make more room for large items.

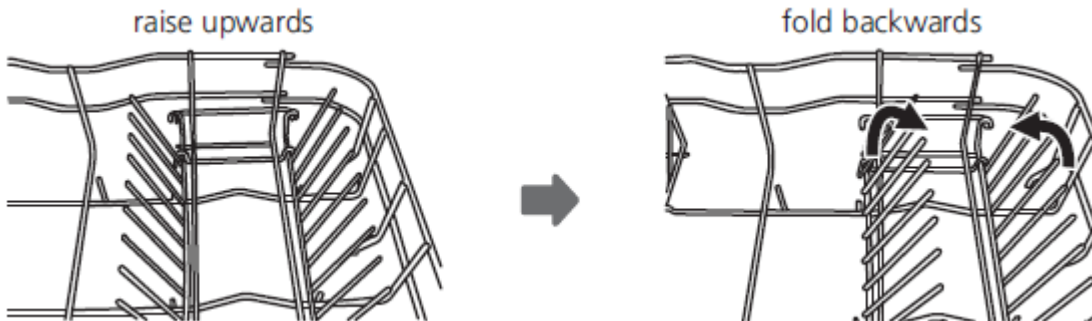

## Preparing and Loading Dishes

- Consider buying utensils which are identified as dishwasher-proof.
- For particular items, select a program with the lowest possible temperature.
- To prevent damage, do not take glass and cutlery out of the dishwasher immediately after the program has ended.

## For washing the following cutlery/dishes

### Are not suitable

- Cutlery with wooden, horn china or mother-of-pearl handles
- Plastic items that are not heat resistant
- Older cutlery with glued parts that are not temperature resistant
- Bonded cutlery items or dishes
- Pewter or cooper items
- Crystal glass
- Steel items subject to rusting
- Wooden platters
- Items made from synthetic fibers

### Are of limited suitability

- Some types of glasses can become dull after a large number of washes
- Silver and aluminum parts have a tendency to discolor during washing
- Glazed patterns may fade if machine washed frequently

# Loading the Dishwasher

## Recommendations for loading the dishwasher

Scrape off any large amounts of leftover food. Soften remnants of burnt food in pans. It is not necessary to rinse the dishes under running water.

For best performance of the dishwasher, follow these loading guidelines.

Place objects in the dishwasher in following way:

- Items such as cups, glasses, pots, pans, etc. are faced downwards.
- Curved items, or ones with recesses, should be loaded aslant so that water can run off.
- All utensils are stacked securely and cannot tip over.
- All utensils are placed in the way that the spray arms can rotate freely during washing.
- Load hollow items such as cups, glasses, pans etc. With the opening facing downwards so that water cannot collect in the container or a deep base.
- Dishes and items of cutlery must not lie inside one another, or cover each other.
- To avoid damage, glasses should not touch one another.
- The upper basket is designed to hold more delicate and lighter dishware such as glasses, coffee and tea cups.
- Long bladed knives stored in an upright position are a potential hazard!
- Long and sharp items of cutlery such as carving knives must be positioned horizontally in the upper basket.
- Please do not overload your dishwasher. This is important for good results and for reasonable consumption of energy.

### **NOTE:**

Very small items should not be washed in the dishwasher as they could easily fall out of the basket.

**WARNING:** Do not let any item extend through the bottom. Always load sharp utensils with the sharp point down.



**WARNING: Items will be hot!** To prevent damage, do not take glass and cutlery out of the dishwasher for around 15 minutes after the program has ended.

## Programming The Dishwasher

### Wash Cycle Table

The table below shows which programs are best for the levels of food residue on them and how much detergent is needed. It also show various information about the programs.

(●) Means: need to fill rinse into the Rinse-Aid Dispenser.

Program	Description Of Cycle	Detergent Pre/Main	Running Time(min)	Energy (Kwh)	Water (L)	Rinse Aid
 <b>Intensive</b>	Pre-wash(50°C) Wash(60°C) Rinse Rinse Rinse(65°C) Drying	$\frac{5/25g}{(1 \text{ or } 2 \text{ pieces})}$	170	1.6	18.5	●
<b>ECO</b> <small>*AS/NZS 2007.1)</small>	Wash(45°C) Rinse Rinse(45°C) Drying	$\frac{5/25g}{(1 \text{ or } 2 \text{ pieces})}$	185	0.73	10.7	●
 <b>90 mins</b>	Wash(65°C) Rinse Rinse(65°C) Drying	$\frac{30g}{(1 \text{ or } 2 \text{ pieces})}$	90	1.2	11.5	●
 <b>Rapid</b>	Wash(40°C) Rinse Rinse(60°C)	25g	30	0.6	11.5	○

## Starting a Cycle Wash

1. Draw out the lower and upper basket, load the dishes and push them back. It is commended to load the lower basket first, then the upper one.
2. Pour in the detergent.
3. Insert the plug into the socket. The power supply refer to last page "Product fiche". Make sure that the water supply is turned on to full pressure.
4. Close the door, press the Power button, to switch on the machine.
5. Choose a program, the response light will turn on. Then press the Start/Pause button, the dishwasher will start its cycle.

## Changing the Program Mid-cycle

A wash cycle can only be changed if it has been running for a short time otherwise, the detergent may have already been released and the dishwasher may have already drained the wash water. If this is the case, the dishwasher needs to be reset and the detergent dispenser must be refilled. To reset the dishwasher, follow the instructions below:

1. Press the Start/Pause button to pause the washing.
2. Press the Program button for more than 3 seconds, the dishwasher will enter standby mode.
3. Press the Program button to select the desired program.
4. Press the Start/Pause button, the dishwasher will run after 10 seconds.

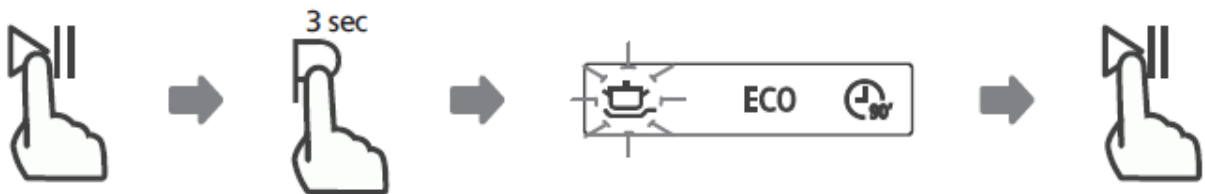

### **⚠ WARNING**



It is dangerous to open the door mid-cycle, as hot steam may scald you.



### External Care

#### The door and the door seal

Clean the door seals regularly with a soft damp cloth to remove food deposits. When the dishwasher is being loaded, food and drink residues may drip onto the sides of the dishwasher door. These surfaces are outside the wash cabinet and are not accessed by water from the spray arms. Any deposits should be wiped off before the door is closed.

#### The control panel

If cleaning is required, the control panel should be wiped with a soft damp cloth only.

#### **WARNING:**

- To avoid penetration of water into the door lock and electrical components, do not use a spray cleaner of any kind.
- Never use abrasive cleaners or scouring pads on the outer surfaces because they may scratch the finish. Some paper towels may also scratch or leave marks on the surface.

### Internal Care

#### Filtering system

The filtering system in the base of the wash cabinet retains coarse debris from the washing cycle. The collected coarse debris may cause the filters to clog. Check the condition of the filters regularly and clean them if necessary under running water. Follow the steps below to clean the filters in the wash cabinet.

## Internal Care

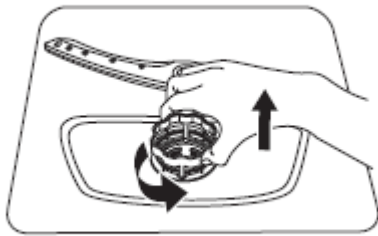

1. Hold the coarse filter and rotate it anticlockwise to unlock the filter. Lift the filter upwards and out of the dishwasher.

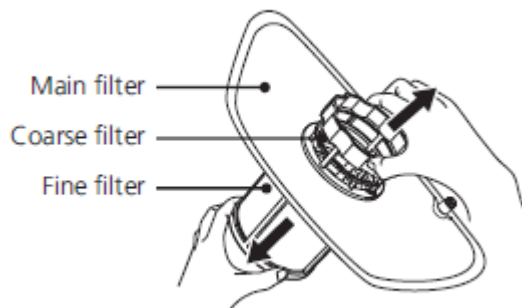

2. The fine filter can be pulled off the bottom of the filter assembly. The coarse filter can be detached from the main filter by gently squeezing the tabs at the top and pulling it away.



3. Larger food remnants can be cleaned by rinsing the filter under running water. For a more thorough clean, use a soft cleaning brush.

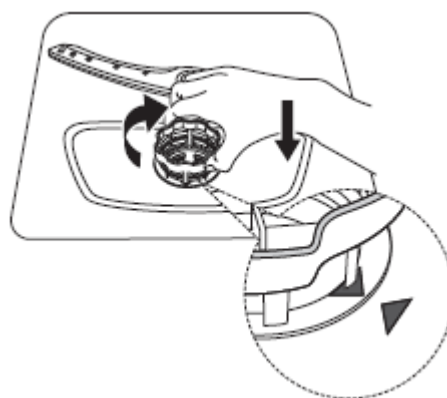

4. Reassemble the filters in the reverse order of the disassembly, replace the filter insert, and rotate clockwise to the close arrow.

### WARNING

- Do not over tighten the filters. Put the filters back in sequence securely, otherwise coarse debris could get into the system and cause a blockage.
- Never use the dishwasher without filters in place. Improper replacement of the filter may reduce the performance level of the appliance and damage dishes and utensils.

## Internal Care

It is necessary to clean the spray arms regularly for hard water chemicals will clog the spray arm jets and bearings.

To clean the spray arms, follow the instructions below:

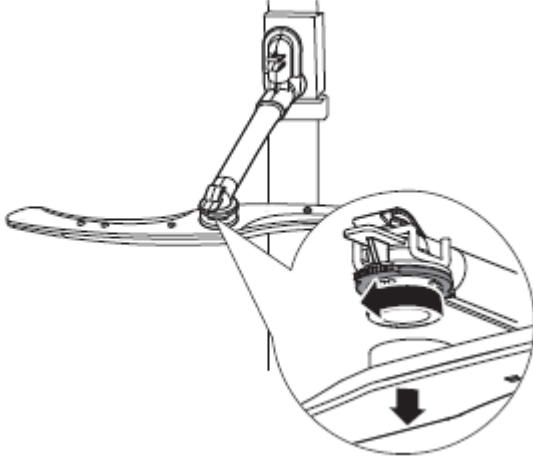

1. To remove the upper spray arm, hold the nut, rotate the arm clockwise to remove it.

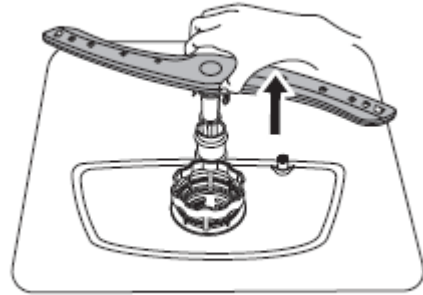

2. To remove the lower spray arm, pull out the spray arm upward.

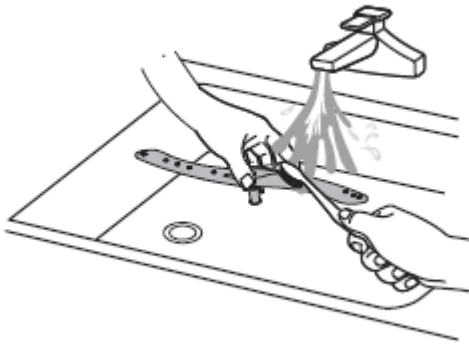

3. Wash the arms in soapy and warm water and use a soft brush to clean the jets. Replace them after rinsing them thoroughly.

## Caring For The Dishwasher

### **Frost precaution**

Please take frost protection measures on the dishwasher in winter. Every time after washing cycles, please operate as follows:

1. Cut off the electrical power to the dishwasher at the supply source.
2. Turn off the water supply and disconnect the water inlet pipe from the water valve.
3. Drain the water from the inlet pipe and water valve. (Use a pan to gather the water)
4. Reconnect the water inlet pipe to the water valve.
5. Remove the filter at the bottom of the tub and use a sponge to soak up water in the sump.

### **After every wash**

After every wash, turn off the water supply to the appliance and leave the door slightly open so that moisture and odors are not trapped inside.

### **Remove the plug**

Before cleaning or performing maintenance, always remove the plug from the socket.

### **No solvents or abrasive cleaning**

To clean the exterior and rubber parts of the dishwasher, do not use solvents or abrasive cleaning products. Only use a cloth with warm soapy water.

To remove spots or stains from the surface of the interior, use a cloth dampened with water and a little vinegar, or a cleaning product made specifically for dishwashers.

### **When not in use for a longtime**

It is recommended that you run a wash cycle with the dishwasher empty and then remove the plug from the socket, turn off the water supply and leave the door of the appliance slightly open. This will help the door seals to last longer and prevent odors from forming within the appliance.

### **Moving the appliance**

If the appliance must be moved, try to keep it in the vertical position. If absolutely necessary, it can be positioned on its back.

### **Seals**

One of the factors that cause odours to form in the dishwasher is food that remains trapped in the seals. Periodic cleaning with a damp sponge will prevent this from occurring.

## Troubleshooting Tips

### Before Calling For Service

Reviewing the charts on the following pages may save you from calling for service.

<b>Problem</b>	<b>Possible Causes</b>	<b>What to Do</b>
Dishwasher doesn't start	Power supply is not turned on.	Make sure the dishwasher is turned on and the door is closed securely. Make sure the power cord is properly plugged into the wall socket.
	Door of dishwasher not properly closed.	Make sure to close the door properly and latch it.
Water not pumped from dishwasher	Twisted or trapped drain hose.	Check the drain hose.
	Filter clogged.	Check the kitchen sink to make sure it is draining well. If the problem is the kitchen sink that is not draining, you may need a plumber rather than a serviceman for dishwashers.
	Kitchen sink clogged.	Check the kitchen sink to make sure it is draining well. If the problem is the kitchen sink that is not draining, you may need a plumber rather than a serviceman for dishwashers.
Suds in the tub	Wrong detergent.	Use only the special dishwasher detergent to avoid suds. If this occurs, open the dishwasher and let suds evaporate. Add 1 gallon of cold water to the bottom of the dishwasher. Close the dishwasher door, then select any cycle. Initially, the dishwasher will drain out the water. Open the door after draining stage is complete and check if the suds have disappeared. Repeat if necessary.
	Spilled rinse-aid.	Always wipe up rinse-aid spills immediately.

## Troubleshooting Tips

<b>Problem</b>	<b>Possible Causes</b>	<b>What to Do</b>
Stained tub interior	Detergent with colourant may have been used.	Make sure that the detergent has no colourant.
White film on inside surface	Hard water minerals.	To clean the interior, use a damp sponge with dishwasher detergent and wear rubber gloves. Never use any other cleaner than dishwasher detergent otherwise, it may cause foaming or suds.
There are rust stains on cutlery	The affected items are not corrosion resistant.	The items should be corrosion resistant.
Knocking noise in the dishwasher	A spray arm is knocking against an item in a basket	Interrupt the program and rearrange the items which are obstructing the spray arm.
Rattling noise in the dishwasher	Items of crockery are loose in the dishwasher.	Interrupt the program and rearrange the items of crockery.
Knocking noise in the water pipes	This may be caused by on-site installation or the cross-section of the piping.	This has no influence on the dishwasher function. If in doubt, contact a qualified plumber.
Cloudiness on glassware.	Combination of soft water and too much detergent.	Use less detergent if you have soft water and select a shorter cycle to wash the glassware and to get them clean.
Black or grey marks on dishes	Aluminium utensils have rubbed against dishes	Use a mild abrasive cleaner to eliminate those marks.
Detergent left in dispenser	Dishes block detergent dispenser	Re-loading the dishes properly.

## Troubleshooting Tips

<b>Problem</b>	<b>Possible Causes</b>	<b>What to Do</b>
The dishes are not clean	The dishes were not loaded correctly.	See notes in "Loading your dishwasher".
	The program was not powerful enough.	Select a more intensive program.
	Not enough detergent was dispensed.	Use more detergent, or change your detergent.
	Items are blocking the movement of the spray arms.	Rearrange the items so that the spray can rotate freely.
	The filter combination is not clean or is not correctly fitted in the base of wash cabinet. This may cause the spray arm jets to get blocked	Clean and/or fit the filter correctly. Clean the spray arm jets.
The dishes aren't drying	Wrong program has been selected.	With a short program, the washing temperature is lower, decreasing cleaning performance.  Choose a program with a long washing time.
	Use of cutlery with a low-quality coating.	Water drainage is more difficult with these items. Cutlery or dishes of this type are not suitable for washing in the dishwasher.

## Troubleshooting Tips

### Error Codes

If there is a malfunction, the dishwasher will display error codes to identify these:

Code	Meanings	Possible Causes
The Rapid indicator fleets frequently	Longer inlet time.	Faucets is not opened, or water intake is restricted, or water pressure is too low.
The 90 mins and Rapid indicator fleets frequently	Not reaching required temperature.	Malfunction of heating element.
The ECO indicator fleets frequently	Overflow.	Some element of dishwasher leaks.

### WARNING:

- If overflow occurs, turn off the main water supply before calling a service.
- If there is water in the base pan because of an overfill or small leak, the water should be removed before restarting the dishwasher.



## Appliance Details

### Electrical Details:

Rated voltage:	220-240V, 50Hz
Maximum rated input:	1760-2100W
Water pressure:	0.04-1.00MPa
Capacity:	12 Settings

### Dimension Details:

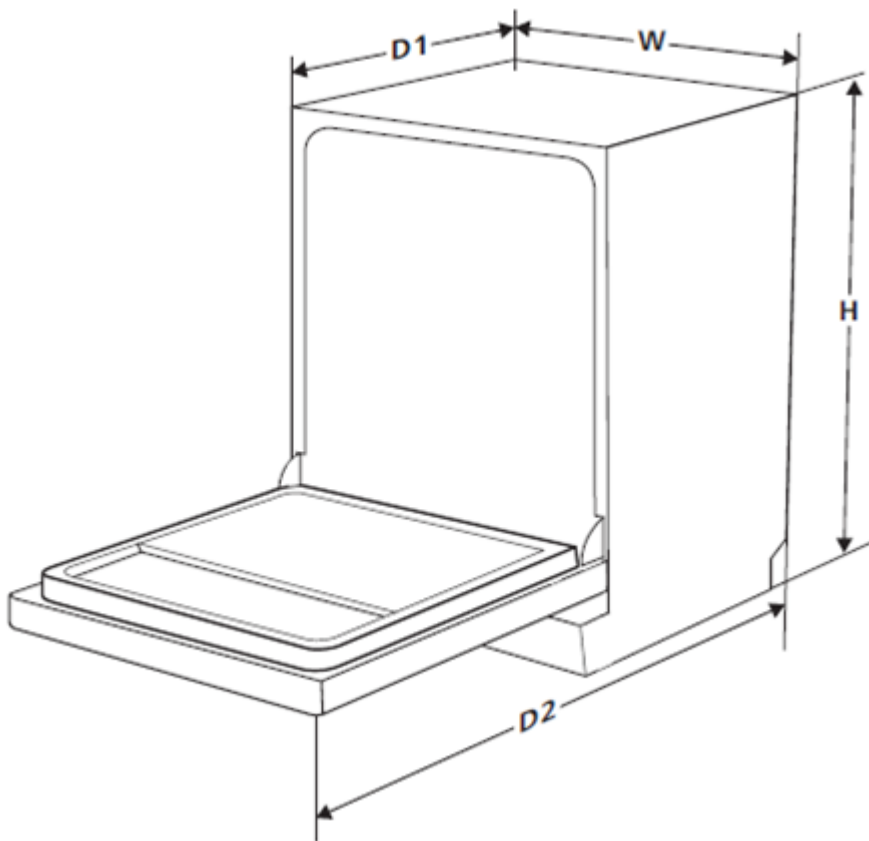

Height (H)	845 mm
Width (W)	598 mm
Depth (D1)	600 mm (with the door closed)
Depth (D2)	1175 mm (with the door opened 90°)

## Disposal

Dispose of the dishwasher packaging material correctly.

All packaging materials can be recycled.

Plastic parts are marked with the standard international abbreviations:

PE	for polyethylene, e.g. sheet wrapping material
PS	for polystyrene, e.g. padding material
POM PP	polyoxymethylene, e.g. plastic clips polypropylene, e.g. Salt filler
ABS	Acrylonitrile Butadiene Styrene, e.g. Control Panel .



- Packaging material could be dangerous for children!
- For disposing of package and the appliance please go to a recycling centre. Therefore cut off the power supply cable and make the door closing device unusable.
- Cardboard packaging is manufactured from recycled paper and should be disposed in the waste paper collection for help recycling.
- By ensuring this product is disposed of correctly, you will prevent potential negative consequences for the environment and human health, which could otherwise be caused by inappropriate waste handling of this product.
- For more detailed information about recycling of this product, please contact your local city office and your household waste disposal service.

**DISPOSAL:** Do not dispose this product as unsorted municipal waste. Collection of such waste separately for special treatment is necessary.

Loading the baskets according to (\*AS/NZS 2007.1) :

1.Upper basket:

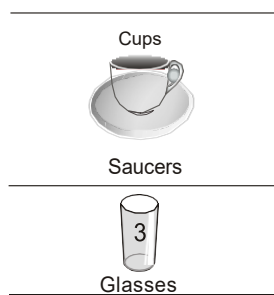
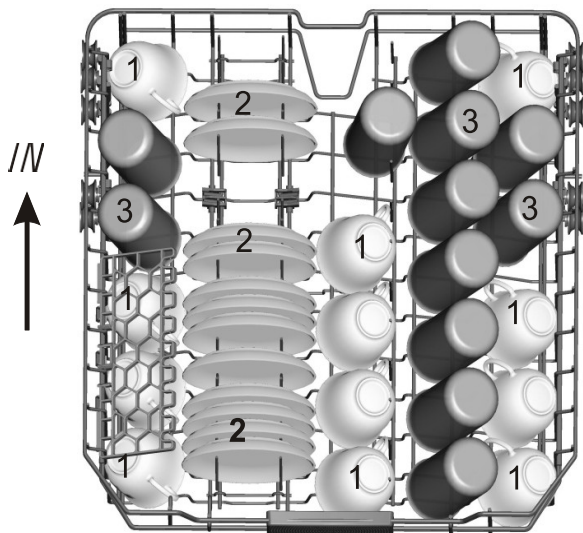

2.Lower basket:

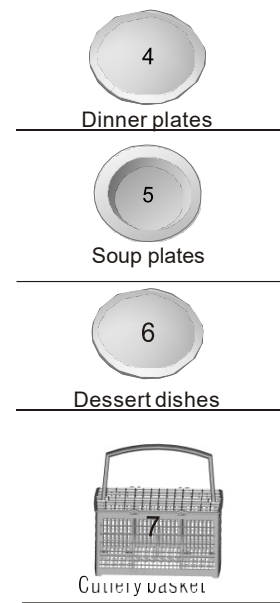
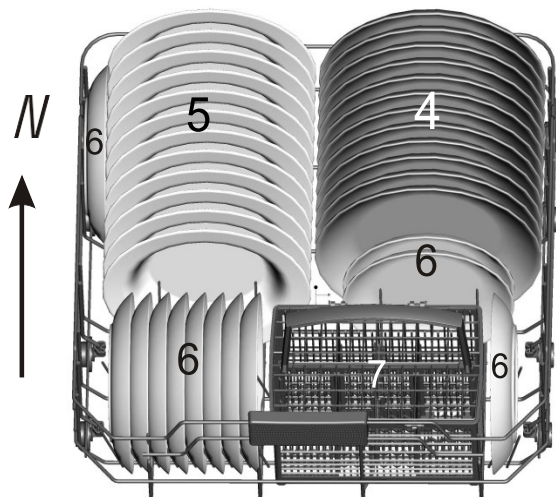

1.Cutlery basket:

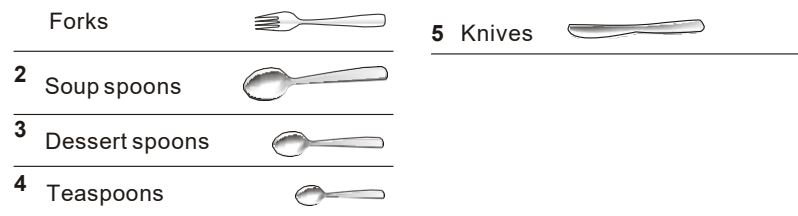
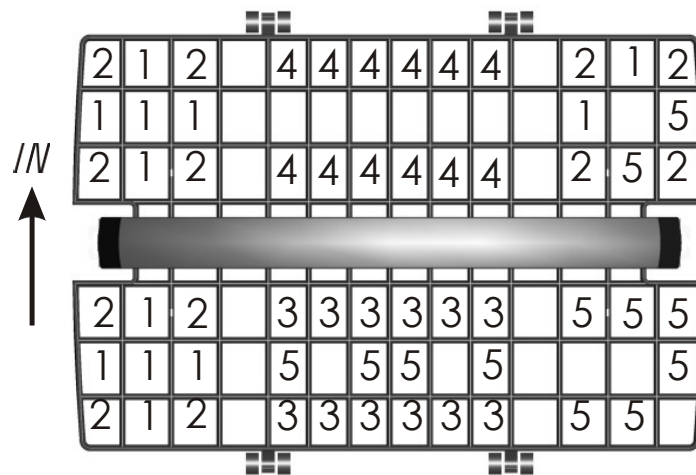

Information for comparability tests in accordance with (\*AS/NZS 2007.1)

- Capacity: 12 place settings
- Position of the upper basket: lower position
- Programme: Normal
- Rinse aid setting: 6 or max
- **Open the door slightly 50mm to assist in drying of the dishes after every wash**

## Warranty Certificate (Australia)

### Terms and Conditions

If you are a consumer under the Australian Consumer Law, our goods come with guarantees that cannot be excluded under the Australian Consumer Law. You are entitled to a replacement or refund for a major failure and for compensation for any other reasonably foreseeable loss or damage. You are also entitled to have the goods repaired or replaced if the goods fail to be of acceptable quality and the failure does not amount to a major failure

1. Robinhood Australia Pty Limited ("Robinhood") also warrants the following Robinhood products against manufacturing defects and faulty materials, under normal use and subject to the exclusions in this certificate, for a period of:

**Rangehood, Ovens, Cooktops, Dishwashers** - 24 months from date of original purchase for domestic use.

**Uniduct** – 12 months from date of original purchase for domestic use.

**Ironing centre** – 12 months from date of original purchase for domestic use.

**Taps, including Pull-out and Mixer taps** – 5 years on parts only from date of original purchase domestic for use, 24 months parts and labour from date of original purchase for domestic use

**Sinks sets**– 5 years on stainless steel sink including draining bench from date of original purchase for domestic use, 6 months on all stainless steel accessories, including wire rack, colander and tray from date of original purchase for domestic use.

**Laundry Tub** - 5 years on stainless bowl, 24 months on Tap, Cabinet and other components from the date of original purchase for domestic use.

"Original purchase", when used in this certificate, means purchase by the customer directly from Robinhood or one of its approved suppliers.

2. This warranty is limited to the repair or replacement, at our option, within the warranty period of any component part which we at our discretion determine to contain faulty materials or a manufacturing defect in breach of this warranty. This warranty is subject to terms and conditions set out in this certificate.

3. The warranty only applies within Australia.

4. For warranty service outside of capital city metropolitan area or 30 km from nearest authorised service agent you will be liable for reasonable travelling expenses and the cost of transport of the product or parts to and from the service agent

5. To make a claim under this warranty, you must produce the original invoice or other purchase documentation as proof of the original purchase date. You must send your claim to Robinhood Australia Pty Limited, 76 Postle Street, Coopers Plains QLD 4108 within 7 days of any alleged defect or failure of the product first becoming apparent, you are responsible for the expense of making a claim under this warranty.

This warranty is given by:

Robinhood Australia Pty Ltd

ABN 83 004 568 138

Telephone: 1800 648 556

Facsimile: 1800 628 577

Email: [enquiries@robinhood.com.au](mailto:enquiries@robinhood.com.au)

[www.robinhood.com.au](http://www.robinhood.com.au)

Attention Customer Services Manager

### Warranty exclusions

1. The warranty does not apply where, in Robinhood's opinion:

The defect is caused by misuse, wear and tear, dirt, fire or accidental damage.

The product has been repaired or serviced by an unauthorised person.

The product was not installed in accordance with our instructions.

The product was purchased overseas or was not designed for use in Australia.

The product was not used, cleaned or cared for in accordance with our instructions.

The product was used outdoors.

2. All Robinhood Rangehoods are suitable for indoor use only and not suitable over BBQs or charcoal cookers designed for outdoor use.

3. In addition, this warranty does not extend to damage or defects which in our opinion, directly or indirectly arise from or are due to: exposing the product to acidic or corrosive materials or chemicals such as dyes, solvents, denture cleaner or acetone; using inappropriate household cleaning products such as abrasive cream or powder cleansers, furniture polish, bleach, mentholated spirits, drain cleaners, sugar soap, metal pads and strongly alkaline or acidic cleaners; heat damage, including from washing the product at high temperatures; impact or mishandling the product, including the impact caused by objects scraped along, thrown or dropped on the product surface or excessive weight being placed on the product; structural or support changes in or affecting the building or the application where the product has been installed; failure to clean or maintain the product as recommended; or any other causes specified in the product information as being excluded from this warranty.

4. Variations with the colour or gloss within the product or any ageing or fading of colour, shine or gloss level over time are not covered by this warranty. The warranty does not cover visual imperfections or blemishes in the surface and edges of the product that were not brought to your supplier's attention at the time you inspected the product.

5. We will not be responsible under this warranty for, nor pay the costs of, removing the existing product, or reinstalling the new product, or any associated costs or damages.

6. Charcoal filters and light bulbs are not covered by this warranty

The benefits given by this warranty are in addition to other rights and remedies of consumers under any law in relation to the goods which cannot be excluded.

This warranty certificate is not intended to create a contract between Robinhood Australia Pty Limited and the purchaser.

### Should you require service please contact us on:

#### Australia

Shriro Australia Pty Limited

ABN 83004568138

Telephone: 1800 648 556

Facsimile: 1800 628 577

Email: [enquiries@robinhood.com.au](mailto:enquiries@robinhood.com.au)

[www.robinhood.com.au](http://www.robinhood.com.au)

## Warranty Certificate (New Zealand)

### Terms and Conditions

The following conditions apply in respect of the warranty given in this certificate:

1. Robinhood (NZ) Limited warrants the following Robinhood products against manufacturing defects and faulty materials, under normal use and subject to the exclusions in this certificate, for a period of:  
**Rangehood, Ovens, Cooktops, Dishwashers** - 24 months from date of original purchase for domestic use.  
**Uniduct** – 12 months from date of original purchase for domestic use.  
**Ironing centre** – 12 months from date of original purchase for domestic use.  
**Taps, including Pull-out and Mixer taps** – 5 years on parts only from date of original purchase domestic for use, 24 months parts and labour from date of original purchase for domestic use  
**Sinks sets**– 5 years on stainless steel sink including draining bench from date of original purchase for domestic use, 6 months on all stainless steel accessories, including wire rack, colander and tray from date of original purchase for domestic use.  
**Laundry Tub** - 5 years on stainless bowl, 24 months on Tap, Cabinet and other components from the date of original purchase for domestic use.

“Original purchase”, when used in this certificate, means purchase by the customer directly from Robinhood or one of its approved suppliers.

2. This warranty is limited to the repair or replacement, at our option, within the warranty period of any component part which we at our discretion determine to contain faulty materials or a manufacturing defect in breach of this warranty. This warranty is subject to terms and conditions set out in this certificate.
3. The warranty only applies within New Zealand.
4. The customer must produce the original invoice or other purchase documentation as proof of the original purchase date.

### Warranty exclusions

1. The warranty does not apply where, in Robinhood’s opinion:  
The defect is caused by misuse, wear and tear, dirt, fire or accidental damage.  
The product has been repaired or serviced by an unauthorised person.  
The product was not installed in accordance with our instructions.  
The product was purchased overseas or was not designed for use in New Zealand.  
The product was not used, cleaned or cared for in accordance with our instructions.  
The product was used outdoors.
2. In addition, this warranty does not extend to damage or defects which in our opinion, directly or indirectly arise from or are due to:  
Exposing the product to acidic or corrosive materials or chemicals such as dyes, solvents, denture cleaner or acetone;  
Using inappropriate household cleaning products such as abrasive cream or powder cleansers, furniture polish, bleach, mentholated spirits, drain cleaners, sugar soap, metal pads and strongly alkaline or acidic cleaners;  
Heat damage, including from washing the product at high temperatures;  
Impact or mishandling the product, including the impact caused by objects scraped along, thrown or dropped on the product surface or excessive weight being placed on the product;  
Structural or support changes in or affecting the building or the application where the product has been installed;  
Failure to clean or maintain the product as recommended; or  
any other causes specified in the product information as being excluded from this warranty.
3. Variations with the colour or gloss within the product or any ageing or fading of colour, shine or gloss level over time are not covered by this warranty. The warranty does not cover visual imperfections or blemishes in the surface and edges of the product that were not brought to your supplier’s attention at the time you inspected the product.
4. Costs incurred on installation or removal of a product, or any reinstallation of a product, or any associated costs, are not covered by this warranty.
5. Robinhood will not be liable for consequential or indirect loss or damage whatsoever and however arising out of or in connection with the supply, performance or removal of the product, including (but not limited to) loss of profit, loss of revenue, loss of contract, loss of goodwill or increased cost of workings, even if due to the negligence of Robinhood or any of its approved suppliers, employees or agents.
6. Charcoal filters and light bulbs are not covered by this warranty
7. This warranty and the statements contained in this certificate or other documents given to you do not exclude, restrict or modify the application of any term implied into this warranty by statute, provided that (to the extent any statutory provision permits Robinhood to limit its liability for a breach of an implied condition or warranty) Robinhood’s liability for such breach is limited to the payment of the cost of replacing the product, repairing the product or acquiring an equivalent product.
8. Subject to clause 5, our obligations under this warranty are limited to those set out in this certificate, and this warranty is expressly instead of all other warranties, express or implied, including any implied warranty of merchantability or fitness for a particular purpose and notwithstanding any course of dealing between the parties or custom and usage in trade to the contrary.

Terms and conditions are subject to change.

29

### Should you require service please contact us on:

#### New Zealand

Monaco Corporation Limited  
Telephone: 0800 760 667  
Facsimile: 0800 276 246  
Email: [enquiries@robinhood.co.nz](mailto:enquiries@robinhood.co.nz)  
[www.robinhood.co.nz](http://www.robinhood.co.nz)