

Description: **ROBINHOOD CONDENSOR DRYER 7KG WHITE**

Model Number: **RHCD7W**



**Model pictured: RHCD7W**

*Actual unit may differ from image above*

# Contents

## Congratulations!

Thank you for choosing one of our appliances. Before you use the appliance, we strongly recommend that you read through the whole user manual which provides important safety instructions and description of the product and the proper use of its functions.

To avoid the ever-present risks involved with using an electrical appliance it is vital that the oven is installed correctly and that you read the safety instructions carefully to avoid misuse and hazards. It is important that you retain these instructions and your proof of purchase along with any other important documents about this product for future reference.

Due to continual product development, Robinhood reserves the right to alter specifications or appearances without notice.

|  |       |
|--|-------|
| Important Safety Instructions.....       | 1-2   |
| Appliance Details.....                   | 3     |
| Installation.....                        | 4     |
| Operating Instructions.....              | 5-14  |
| Cleaning and Maintenance.....            | 15-16 |
| Troubleshooting.....                     | 17    |
| Warranty certificate (New Zealand) ..... | 18    |
| Warranty certificate (Australia) .....   | 19    |

## Disposal Information

- Most of the packing materials are recyclable. Please dispose of these materials through your local recycling depot or by placing them in appropriate collection containers.
- If you wish to discard this product, please contact your local authorities and ask for the correct method of disposal.

## Important Safety Instructions

**When using electrical appliances, in order to reduce the risk of fire, electric shock, and/or injury to persons, basic safety precautions should always be followed, including**

- This appliance is not intended for use by persons (including children) with reduced physical, sensory or mental capabilities, or lack of experience and knowledge, unless they have been given supervision or instruction concerning use of the appliance by a person responsible for their safety. Young children should be supervised to ensure that they do not play with the appliance.
- The tumble dryer is not to be used if industrial chemicals have been used for cleaning.
- The lint trap has to be cleaned frequently.
- The lint trap must to be allowed to accumulate around the tumble dryer.
- Adequate ventilation has to be provided to avoid the back flow of gases into the room from appliance burning other fuels, including open fires.
- Do not dry unwashed items in the tumble dryer.
- Items that have been soiled with substances such as cooking oil, acetone, alcohol, petrol, kerosene, spot removers, turpentine, waxes and wax removers should be washed in hot water with an extra amount of detergent before being dried in the tumble dryer.
- Items such as foam rubber (latex foam), shower caps, rubber backed articles and clothes or pillows fitted with foam rubber pads should not be dried in the tumble dryer.
- Fabric softeners, or similar products, should be used as specified by the fabric softener instructions.
- The final part of a tumble dryer cycle occurs without heat (cool down cycle) to ensure that the items are left at a temperature that ensures that the items will not be damaged.
- The exhaust air must not be discharged into a flue which is used for exhausting fumes from appliances burning gas or other fuels.
- The appliance must not be installed behind a lockable door, a sliding door or a door with a hinge on the opposite to that of the tumble dryer, in such a way that a full opening of the tumble dryer door is restricted.
- If the supply cord is damaged, it must be replaced by the manufacturer, its service agent or similarly qualified persons in order to avoid a hazard.
- Oil-affected items can ignite spontaneously, especially when exposed to heat sources such as in a tumble dryer. The items become warm, causing an oxidation reaction in the oil. Oxidation creates heat. If the heat cannot escape, the items can become hot enough to catch fire. Piling, stacking or storing oil-affected items can prevent heat from escaping and so create a fire hazard.
- If it is unavoidable that fabrics that contain vegetable or cooking oil or have been contaminated by hair care products be placed in a tumble dryer they should first be washed in hot water with extra detergent - this will reduce, but not eliminate, the hazard.
- The maximum mass of dry load is 7 Kg.
- **WARNING:** Never stop a tumble dryer before the end of the drying cycle unless all items quickly removed and spread out so that the heat is dissipated.
- **WARNING:** The appliance must not be supplied through an external switching device, such as a timer, or connected to a circuit that is regularly switched on and off by a utility.
- **WARNING:** This appliance is only to be serviced by a qualified person. There are no user-serviceable parts inside.

Symbol    Meaning



Read operator's manual



Warning: Risk of fire / flammable material

## Important Safety Instructions

- In certain circumstances electrical appliances may be a danger hazard. Check the conformity of voltage and power settings, which are specified on the information plate attached to the appliance and/or packaging, with the usage conditions available.
- Do not place heavy objects in or on these appliances, or use for storage, or let children play or swing from the door. Do not use the appliances until fully installed.
- The electrical connection must be accessible after installation. The appliance must be electrically isolated before any maintenance can be performed. The appliance is not intended to be operated by means of an external timer or separate remote control system.
- Fabric softeners or similar products should not be used in a tumble dryer to eliminate the effects of static electricity unless this practice is specifically recommended by the manufacturer of the fabric softener or product.
- Undergarments that contain metal reinforcements should not be placed in a tumble dryer. Damage to the tumble dryer can result if metal reinforcements come loose during drying. When available a drying rack could be used for such items.
- Plastic articles such as shower caps or babies' waterproof napkin covers should not be placed in a tumble dryer.
- Rubber-backed articles, clothes fitted with foam rubber pads, pillows, galoshes and rubber-coated tennis shoes should not be placed in a tumble dryer.
- Do not cover the air inlet or exhaust openings.
- If appliance has ventilation openings in base, ensure carpet does not obstruct the openings.
- The appliance must not be installed behind a lockable door, a sliding door or a door with a hinge on the opposite side to that of the tumble dryer in such a way that a full opening of the tumble dryer door is restricted.
- Undergarments that contain metal reinforcements should not be placed in a tumble dryer. Damage to the tumble dryer can result if metal reinforcements come loose during drying. When available a drying rack could be used for such items.
- Do not cover the air inlet or exhaust openings.
- If appliance has ventilation openings in base, ensure carpet does not obstruct the openings.
- Do not operate the dryer without the filter door and filter base.
- Do not install the dryer in the humid and drenching environment.
- Save these instructions.

INDOOR USE ONLY - this appliance is not intended for outdoor use.

# Appliance details

|                         |   |
|-------------------------|---|
| Model                   | RHCD7W  |
| Maximum Drying Capacity | 7 kg  |
| Rated Voltage           | 220 – 240 V   |
| Rated Frequency         | 50 Hz   |
| Rated Wattage           | 2000 W  |
| Net Weight              | 41 kg   |
| Dimension (WxDxH)       | 595 x 615 x 845 mm (without door frame)<br>595 x 660 x 845 mm (with door frame) |

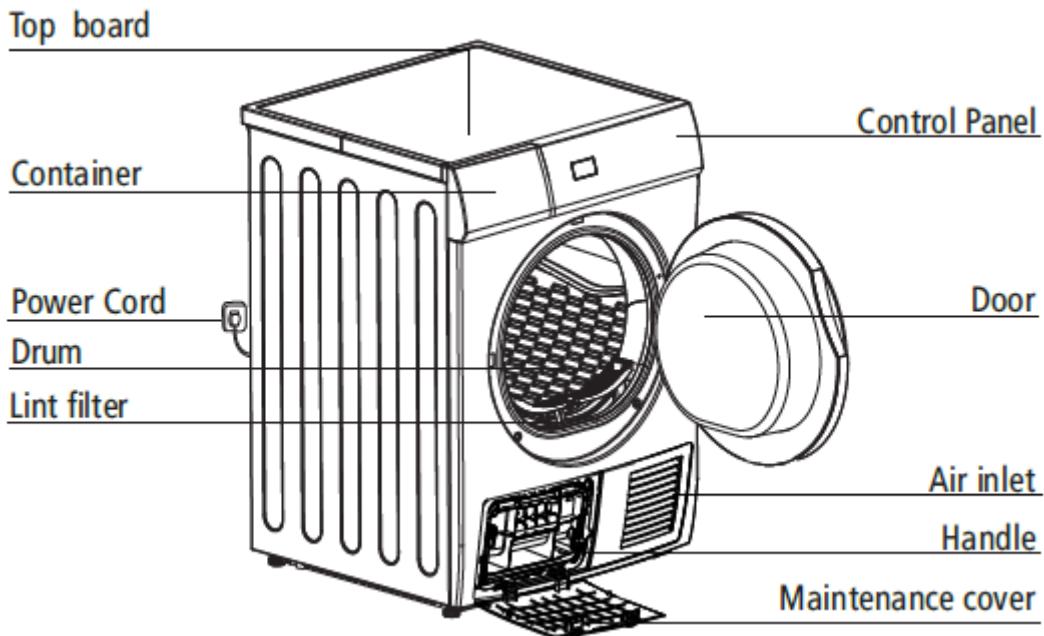

## Accessories

The following parts are optional for specific models.

If your dryer has following parts, please wear gloves and install them following the instruction below.

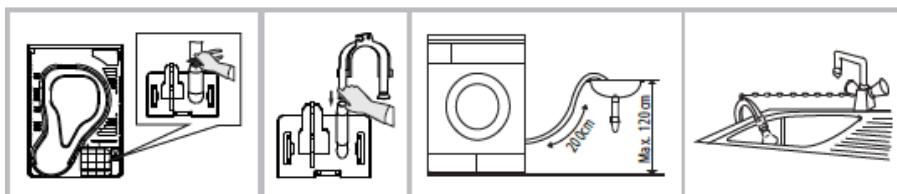
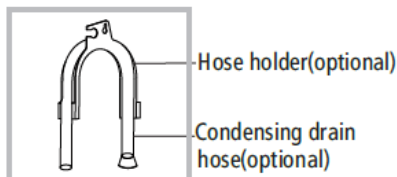

Use pliers to remove the drain hose from the hose connector.

Insert the external drainage hose.

Put the hose holder on the washing basin or any other sink.

# Installation Instructions

## Transport

Move cautiously. Do not grasp any salient parts of machine. The dryer door cannot be used as the handle for delivery.

## Installation Position

1. It is recommended that, for your convenience, the machine is positioned close to your washing machine.
2. The tumble dryer must be installed in a clean place, where dirt does not build up. Air must be able to circulate freely, all round the appliance. Do not obstruct the front air inlet or the air intake grilles at the back of the machine.
3. To keep vibration and noise to a minimum when the dryer is in use, it should be placed on a firm and level surface.
4. The feet must never be removed. Do not restrict the floor clearance through deep pile carpets, strips of wood or similar. This might cause heat built-up which would interfere with the operation of the appliance.

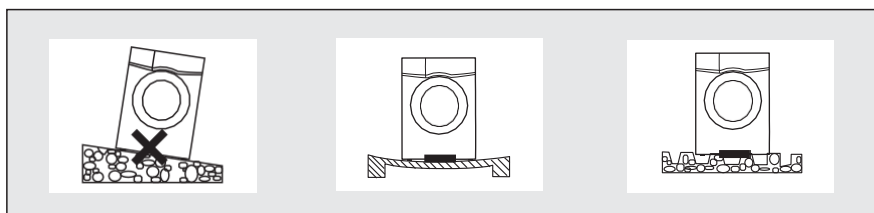

## Level Adjusting

Once in its permanent operating position, check that the dryer is absolutely level with the aid of a spirit level. If it is not, adjust the feet with a tool.

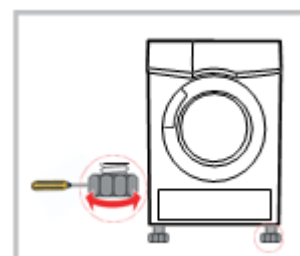

## Power Supply Connection

1. Make sure that the voltage of the power supply is the same as the electric specification of the dryer.
2. Do not connect the dryer with the power connection board, the universal plug or socket.

# Operation Instructions

## Quick Start

### Note!

Before using, please make sure it's installed properly.

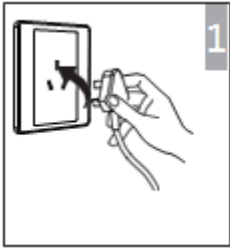

Plug in

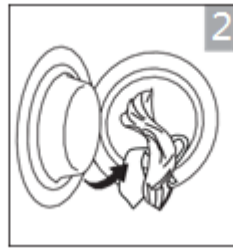

Load

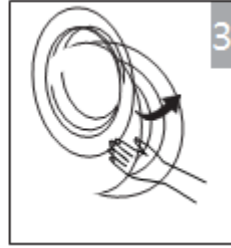

Close door

## Drying



On



Select program



Select function or default



Start

## After Drying

Buzzer beep or "0:00" on display

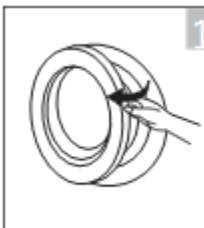

Open the door and take out laundry

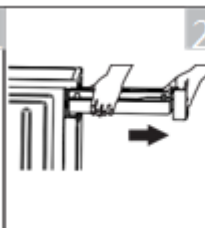

Pull out the container



Pour out condensate water

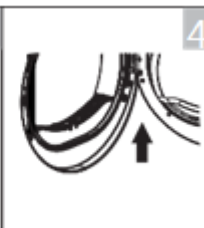

Clean the filter

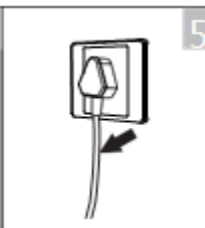

Power off

### Note!

- If socket provided with on/off switch, please switch off the power.

# Operation Instructions

## Before Each Drying











### Attention !

Before the first cycle, the dust and grease may remain in this dryer during the period of manufacture and transportation, to avoid contaminating your clothes, please follow these steps:

- Put some clean rags into the drum.
- Plug the power.
- Select the “Quick” program, press “Start/Pause” button.
- After finishing this program, please follow the “cleaning and maintenance” to clean the lint filter and air condenser.

1. Before drying thoroughly spin the laundry in washing machine. High spin speed can reduce the drying time and save energy consumption.
2. For uniform drying result, sort the laundry according to fabric type and drying program.
3. Before drying, please close zips, hooks and eyelets, button up, tie fabric belts, etc.
4. Do not over dry the clothes, because over dried clothes can easily get creases.
5. Do not dry the articles containing rubber or similar elastic materials.
6. The door can be opened only after the program of the drying machine finishes to prevent human skin from being scalded by hot steam or over heated drying machine.
7. Clean the lint filter and empty container after each use to avoid extension of drying time and energy consumption.
8. Do not dry these clothes after dry-clean process.

The reference weight of dry clothes (each)

|   |   |  |  |
|---|---|--|--|
|  Mixed-fabric clothes<br>(about 800g)      |  Jacket<br>(about 800g cotton)     |  Jeans<br>(about 800g)            |  Towel quilt<br>(about 900g cotton)       |
|  Single bedsheet<br>(about 600g cotton)    |  Work clothes<br>(about 1120g)     |  Sleepwear<br>(about 200g)        |  Long sleeve shirt<br>(about 300g cotton) |
|  Short sleeve shirt<br>(about 180g cotton) |  Short pants<br>(about 70g cotton) |  Socks<br>(about 50g mixed-weave) |  |













### Note!

- Never overload.
- Not for textile with dropping water. The dryer could be damaged, even fire.
- Not suitable for silk or woolen textiles.



# Operation Instructions

Please pay attention to use the drying machine if the materials of your clothes can not be dried by it or contain the symbols as follows:

|   |   |  |  |
|---|---|--|--|
| <br>Dry                    | <br>Normal           | <br>Not tumble dry normal                   | <br>Do not dry                                    |
| <br>Line dry / hang to dry | <br>Drip dry         | <br>Dry flat                                | <br>In the shade                                  |
| <br>Dry clean              | <br>Do not dry clean | <br>Dry clean normal cycle with any solvent | <br>Dry clean normal cycle petroleum solvent only |

## Control Panel

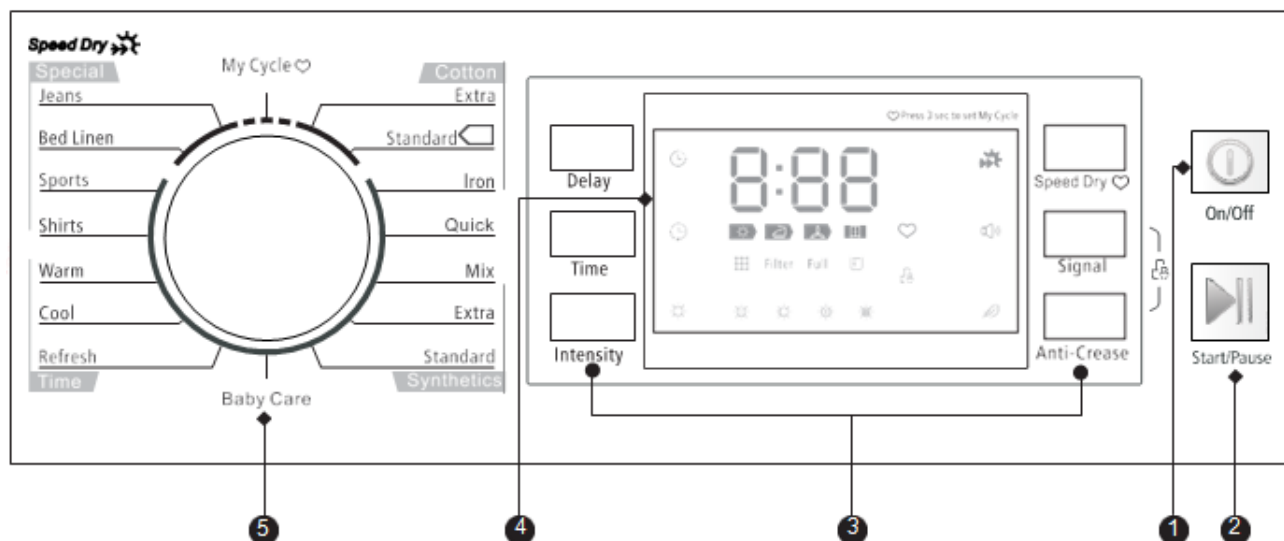

### 1 On / Off

Product is switched on or off.

### 2 Start / Pause

Press the button to start or pause the drying cycle.

### 3 Specialty function

These buttons are used for setting additional functions.













### 4 Display

This display shows the setting, estimated Remaining time and status message of your dryer.

### 5 Program

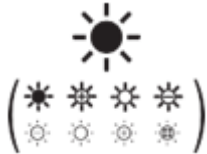
Different dryer cycle can be selected according to the users needs to make the clothes have more effective drying results.

# Operation Instructions

| Display Icon  | Meaning   |
|---|---|
|                  | Filter<br>After the dryer stops, clean filter when icon lights up.  |
|                  | Tank<br>After the dryer stops, empty container when icon lights up. |
|                  | Delay start   |
|                  | Timer   |
|                  | Child lock  |
|                  | Remaining time indicator/Error message                              |
|                 | Cycle phase status  |
|  <b>Filter</b> | Clean filters (warning)   |
| <b>Full</b>    | Empty water container (warning)                                     |
|                | Dryness level (four settings)                                       |
|                | Speed dry indicator   |
|                | Signal indicator  |
|                | Anti-crease mode  |
|                | My cycle  |

# Operation Instructions

## Program selector

1. Press the **【On/Off】** button ,when the LED display screen brightens up, rotate the program knob to select the desired program.
2. Select the **【Delay】** , **【Time】** , **【Intensity】** , **【Speed Dry】** , **【Signal】** or **【Anti-Crease】** functions for additional option.
3. Press the **【Start/Pause】** button.

## Program start

The drum will keep rotating after the program starts, the state light in the display area will flash in sequence, the remaining time displayed will change automatically.

## Program end

1. The drum will stop running after the program ends, the buzzer will beep, the display will show " **0:00**, the last cycle phase status light will flash. The dryer will start **【Anti-crease】** function if user doesn't remove the load in 1 minute. Please press **【On/Off】** key to cut off power and pull the plug out.
2. Deal with the problem according to "Malfunction display and solutions", if there is a unexpected stop during the drying procedure and the dryer show information.

## Other Functions

### • Instructions of the **【Delay】** function

This function is used for delaying clothes drying time within 24 hours. The delay time means the program will start after x hours. When the delay program starts, the time starts to decrease on the display and the delay icon blinks.

### Steps in details

1. Load your laundry and make sure the machine door is closed.
2. Press the **【On/Off】** button, then to turn the program selector knob and select a desired program.
3. You can select the **【Anti-Crease】** or **【Signal】** functions according to your need.
4. To press the **【Delay】** key.
5. Continue to press the **【Delay】** to select the delay time.
6. After the **【Start/Pause】** button is pushed, the dryer is at the run condition. The drying procedure will be automatically performed when the delay time is over.
7. If you push the **【Start/Pause】** button again, the delay function will be paused.
8. If you want to cancel the "Delay" function, please press the **【On/Off】** button.

# Operation Instructions

- **Instructions of the 【Time】 function**

When the warm or cool or refresh program is selected, the 【Time】 button can be used to adjust the drying time in 10 min. steps.

- **Instructions of the 【Intensity】 function**

Used to adjust the dryness level of the laundry. The level has four grades . The drying time increases 3 minutes in every grade.

1. The intensity function can be activated only before the programme start.
2. Press the 【Intensity】 button repeatedly to select the drying time.
3. Except the 【Cotton Iron】 【Quick】 【Synthetic Iron】 【Baby Care】 【Warm】 【Cool】 【Refresh】 , all the other programs can be the 【Intensity】 function.

- **Instructions of the 【Speed dry】**

Use to curtail shorten the drying time, the 【Cotton Extra】 【Cotton Standard】 【Mix】 【Jean】 program can be set the function.

- **Instructions of the 【Signal】 function**

Set up the buzzer on or off. In the general condition, the buzzer is on. Please press it if needed. When the buzzer on:

1. The dryer will give the leading sound if press the extra function buttons.
2. If the dryer is running, rotate the function choosing knob, the dryer will remind the operator it is an invalid choose.
3. When the drying programme is end, the buzzer will also remind the user

- **Instructions of the 【Anti-Crease】 function**

At the end of the drying cycle, the anti-crease operation time is 30 minutes (default ) or 120 minutes (selected). The 【Anti-Crease】 light shall illuminate when the anti-crease function is selected. This function prevents the laundry from creases. The laundry can be removed during the anti-crease phase. Except 【Cool】 , 【Refresh】 and 【Baby Care】 , all the other programs have this function.

## Operation Instructions

- **Instructions of the 【My Cycle】 function**

Used to define and save your favorite programs that are used frequently.

1. Use the program selector to select the required program and other drying functions.
2. Press and hold the 【Intensity】 button for 3 seconds until the beep and the required program has been saved.
3. Turn the program selector to the 【My Cycle】 position, you can start your favorite program. If you want to change the 【My Cycle】 settings, repeat the steps 1 and 2.

- **Instructions of the 【Child Lock】 feature**

1. This machine incorporates a special child safety lock, which can prevent children from carelessly pressing keys or making the faulty operation.
2. When the dryer is at the operation state, press the 【Anti-Crease】 and 【Signal】 buttons at the same time for over 3 seconds to start child lock function. When child lock function is set, the display will show child lock icon and no key can effect to the dryer except 【On/Off】 button.  
Under the start state of the child lock, the 【Anti-Crease】 and 【Signal】 buttons shall be pressed at the same time for over 3 seconds to release the child lock function.

# Operation Instructions

Drying Program Table

| Program    | Weight (max)   |       | Application/Properties  | Delay | Time |
|------------|--|-------|---|-------|------|
|            |  | 7.0kg |   |       |      |
| Cotton     | For cottons and colour made of cotton or linen.                      |       |   |       |      |
|            | Extra  | 7.0kg | To dry cotton pieces of clothing. Drying level: extra dry.  | Y     | N    |
|            | Standard   |       | To dry cotton pieces of clothing. Drying level: cupboard dry.   |       |      |
|            | Iron   |       | To dry cotton pieces of clothing. Drying level: applicable to iron.   | Y     | N    |
| Quick      | Quick  | 3.0kg | For washing which is to be dried quickly, eg, made of acrylic fibres or for individual small items. Also for subsequent drying.   | Y     | N    |
| Synthetics | For non-iron washing made of synthetics and blended fabrics, cotton. |       |   |       |      |
|            | Extra  | 3.5kg | To dry thick or multi-layered synthetic fabrics. Drying level: extra dry.   |       |      |
|            | Standard   |       | To dry thin synthetic fabrics which are not ironed, such as easy care shirts, table linen, baby clothes, socks.   | Y     | N    |
| BabyCare   | Baby Care  | 1.0kg | To dry the clothes of the baby at lower temperature.  | Y     | N    |
| Special    | Jean   | 5.0kg | To dry jeans or leisure clothes that is spun at high speeds in the washing machine.   | Y     | N    |
|            | Bed linen  | 5.0kg | To dry bed linen and similar large clothes.   |       |      |
|            | Mix  | 3.5kg | If you cannot determine what the clothing's material is, please choose Mix.   |       |      |
|            | Sports   | 3.0kg | To dry sportswear, thin fabrics, polyester, which are not ironed.   |       |      |
|            | Shirts   | 1.0kg | For easy care clothes such shirts and blouses with anti-crease mechanism for minimum ironing effort. Place clothes loosely in the dryer. Once dried, hang it on a clothes hanger. |       |      |
| My Cycle   | My Cycle   | —     | Define and save your favorite program.  | Y     | —    |
| Time       | Warm   | —     | To warm clothes from minimum 10 minutes to maximum 120 minutes (in 10 minutes steps).   | Y     | Y    |
|            | Cool   | —     | To cool clothes without blowing hot air from minimum 10 minutes to maximum 30 minutes (in 10 minutes steps).  |       |      |
|            | Refresh  | —     | To refresh the clothes that have been kept at closed environments for a long time from minimum 20 minutes to maximum 150 minutes (in 10 minutes steps).                           |       |      |

## Operation Instructions

- This symbol means the energy efficiency test program “standard cotton program”, which is accordance with the applicable EN 61121 standard and most suitable to dry normal cotton load at rated load capacity.
- Thick or multi-layered fabrics, e.g. bedlinen, jeans, jackets etc, are not easy to dry. You'd better choose Cotton Extra program.
- As the uneven material, thick and multi-layered clothes are not easy to dry, it is better to choose the appropriate time drying program to dry them if some parts of the clothes still damp after program finished.



## Cleaning and Care

### Clean the lint filter

Leave the dryer to cool down.

1. Open the machine door.
2. Take out the lint filter, pull upward to take it out.
3. Clean the lint filter; wipe off the scrap threads accumulated on the lint filter, with your hand or rinse with water and dry thoroughly.
4. Reinstall the lint filter.

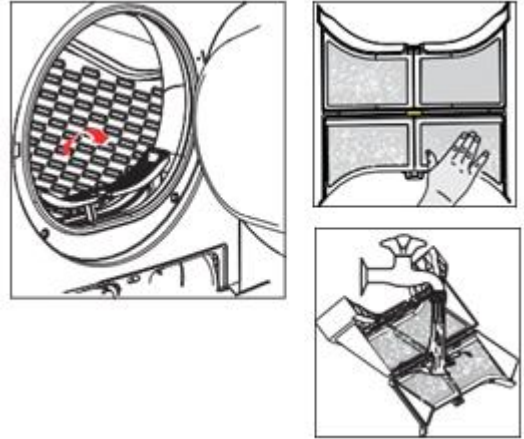

### Note!

- The lint filter accumulated on the filter will block the air circulation, which will cause the extension of drying time and energy use; therefore, the scrap thread filter shall be cleaned after each use.
- Do disconnect the power cord before cleaning!
- Do not operate the dryer without the lint filter!
- Clean the lint filter after each use to prevent lint accumulation inside the dryer.

### Wash air condenser

Leave the dryer to cool down.

Residual water may escape, place an absorbent cloth under the maintenance cover.

1. Unlock the maintenance cover.
2. Completely open maintenance cover.
3. Screw both locking levers towards each other.
4. Pull out the air condenser.
5. Clean the air condenser completely, drains thoroughly.
6. Clean the seals.
7. Re-insert the air condenser, handle at the button!
8. Unscrew both locking levers.
9. Close the maintenance cover until it locks into position.  
Please clean the air condenser approx, once every 3 months if frequently used.  
Do not damage the air condenser.

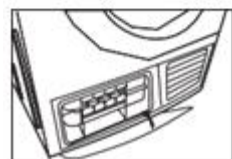
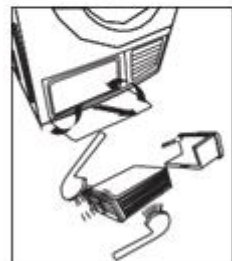
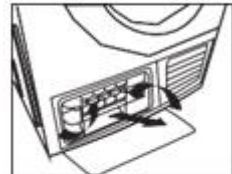
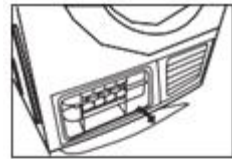

### Warning!

- Clean with water only; do not use hard/sharp-edged objects!  
Do not operate the dryer without the air condenser!
- During drying, water may collect between the window and the seal, but this does not affect the function of your dryer!

## Cleaning and Maintenance

### Empty the water container

1. Hold and pull out the water container with two hands.
2. Tilt the water container, pour out the condensate water.
3. Insert the water container

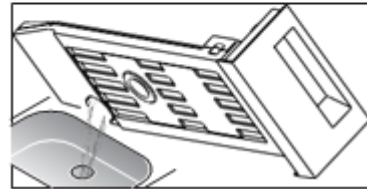
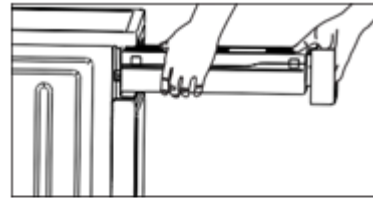

### Warning!



- Empty the water container after each use, the program will be paused and the “” icon will light if the water container is full during the drying process. After the container is emptied, the dryer can be restarted by pressing **【Start/Pause】** button.
- Do not drink the condensate water.
- Do not use the dryer without the water container.

## Troubleshooting

| Alarm Problem | Alarm Reason             | Release   |
|---------------|--------------------------|---|
| " E30 "       | Heating problem          | Please contact your local service center if the problem persists. |
| " E32 "       | Humidity sensor error    |   |
| " E33 "       | Temperature sensor error |   |

### Warning!

- Only authorised technicians can carry out repairs.
- Before you call service, please check if you have dealt with the fault yourself or if you have followed the user instructions.
- A technician will charge you for advice, even during the warranty period.

| Problem   | Solution  |
|---|---|
| • Display does not on   | <ul style="list-style-type: none"> <li>• Check if the power supply works.</li> <li>• Check if the mains plug is inserted.</li> <li>• Check the selected program.</li> <li>• Press the <b>【On/Off】</b> button.</li> </ul>  |
| • "  " is lighting | <ul style="list-style-type: none"> <li>• Empty water container.</li> <li>• If the light is still on, please call the service.</li> </ul>  |
| • "  " is lighting | <ul style="list-style-type: none"> <li>• Clean heat exchanger.</li> <li>• Clear lint filter.</li> </ul>   |
| • Dryer does not start  | <ul style="list-style-type: none"> <li>• Check the door has closed.</li> <li>• Check the program has set.</li> <li>• Check the start button has selected.</li> </ul>  |
| • Degree of dryness was not reached or drying time too long   | <ul style="list-style-type: none"> <li>• Clean lint filter and heat exchanger.</li> <li>• Empty container.</li> <li>• Check drain hose.</li> <li>• Dryer installation place is too restricted.</li> <li>• Clean the moisture sensors.</li> <li>• Keep the Air inlet clean.</li> <li>• Use higher drying intensity level program or time program.</li> </ul> |

### Warning!

If you cannot deal with the fault by yourself and need help:

- Press the **【On/Off】** button.
- Pull out the mains plug and call the service

# Warranty Certificate (New Zealand)

## Terms and Conditions

The following conditions apply in respect of the warranty given in this certificate:

1. Monaco Corporation Limited ("Monaco") warrants the following Robinhood products against manufacturing defects and faulty materials, under normal use and subject to the exclusions in this certificate, for a period of:
  - Rangehood, Ovens, Cooktops, Dishwashers, Refrigeration - 24 months from date of original purchase for domestic use.
  - Uniduct - 12 months from date of original purchase for domestic use.
  - Ironing centre - 12 months from date of original purchase for domestic use.
  - Sinks sets- 5 years on stainless steel sink including draining bench from date of original purchase for domestic use, 6 months on all stainless steel accessories, including wire rack, colander and tray from date of original purchase for domestic use.
  - Laundry Tub - 5 years on stainless bowl, 24 months on Tap, Cabinet and other components from the date of original purchase for domestic use.

"Original purchase", when used in this certificate, means purchase by the customer directly from Monaco or one of its approved suppliers.

2. This warranty is limited to the repair or replacement, at our option, within the warranty period of any component part which we at our discretion determine to contain faulty materials or a manufacturing defect in breach of this warranty. This warranty is subject to terms and conditions set out in this certificate.
3. The warranty only applies within New Zealand.
4. The customer must produce the original invoice or other purchase documentation as proof of the original purchase date.

## Warranty exclusions

1. The warranty does not apply where, in Monaco's opinion:
  - The defect is caused by misuse, wear and tear, dirt, fire or accidental damage. The product has been repaired or serviced by an unauthorised person.
  - The product was not installed in accordance with our instructions.
  - The product was purchased overseas or was not designed for use in New Zealand. The product was not used, cleaned or cared for in accordance with our instructions.
  - The product was used outdoors.
2. In addition, this warranty does not extend to damage or defects which in our opinion, directly or indirectly arise from or are due to:
  - Exposing the product to acidic or corrosive materials or chemicals such as dyes, solvents, denture cleaner or acetone; Using inappropriate household cleaning products such as abrasive cream or powder cleansers, furniture polish, bleach, mentholated spirits, drain cleaners, sugar soap, metal pads and strongly alkaline or acidic cleaners;
  - Heat damage, including from washing the product at high temperatures;
  - Impact or mishandling the product, including the impact caused by objects scraped along, thrown or dropped on the product surface or excessive weight being placed on the product;
  - Structural or support changes in or affecting the building or the application where the product has been installed;
  - Failure to clean or maintain the product as recommended; or any other causes specified in the product information as being excluded from this warranty.
3. Variations with the colour or gloss within the product or any ageing or fading of colour, shine or gloss level over time are not covered by this warranty. The warranty does not cover visual imperfections or blemishes in the surface and edges of the product that were not brought to your supplier's attention at the time you inspected the product.
4. Costs incurred on installation or removal of a product, or any reinstallation of a product, or any associated costs, are not covered by this warranty.
5. Monaco will not be liable for consequential or indirect loss or damage whatsoever and however arising out of or in connection with the supply, performance or removal of the product, including (but not limited to) loss of profit, loss of revenue, loss of contract, loss of goodwill or increased cost of workings, even if due to the negligence of Monaco or any of its approved suppliers, employees or agents.
6. Charcoal filters and light bulbs are not covered by this warranty
7. This warranty and the statements contained in this certificate or other documents given to you do not exclude, restrict or modify the application of any term implied into this warranty by statute, provided that (to the extent any statutory provision permits Monaco to limit its liability for a breach of an implied condition or warranty) Monaco's liability for such breach is limited to the payment of the cost of replacing the product, repairing the product or acquiring an equivalent product.
8. Subject to clause 5, our obligations under this warranty are limited to those set out in this certificate, and this warranty is expressly instead of all other warranties, express or implied, including any implied warranty of merchantability or fitness for a particular purpose and notwithstanding any course of dealing between the parties or custom and usage in trade to the contrary.

Terms and conditions are subject to change.

# Warranty Certificate (Australia)

## Terms and Conditions

If you are a consumer under the Australian Consumer Law, our goods come with guarantees that cannot be excluded under the Australian Consumer Law. You are entitled to a replacement or refund for a major failure and for compensation for any other reasonably foreseeable loss or damage. You are also entitled to have the goods repaired or replaced if the goods fail to be of acceptable quality and the failure does not amount to a major failure.

1. Shriro Australia Pty Limited ("Shriro") also warrants the following Robinhood products against manufacturing defects and faulty materials, under normal use and subject to the exclusions in this certificate, for a period of:
  - Rangehood, Ovens, Cooktops, Dishwashers, Refrigeration - 24 months from date of original purchase for domestic use.
  - Uniduct - 12 months from date of original purchase for domestic use.
  - Ironing centre - 12 months from date of original purchase for domestic use.
  - Sinks sets- 5 years on stainless steel sink including draining bench from date of original purchase for domestic use, 6 months on all stainless steel accessories, including wire rack, colander and tray from date of original purchase for domestic use.
  - Laundry Tub - 5 years on stainless bowl, 24 months on Tap, Cabinet and other components from the date of original purchase for domestic use. "Original purchase", when used in this certificate, means purchase by the customer directly from Shriro or one of its approved suppliers.
2. This warranty is limited to the repair or replacement, at our option, within the warranty period of any component part which we at our discretion determine to contain faulty materials or a manufacturing defect in breach of this warranty. This warranty is subject to terms and conditions set out in this certificate.
3. The warranty only applies within Australia.
4. For warranty service outside of capital city metropolitan area or 30 km from nearest authorised service agent you will be liable for reasonable travelling expenses and the cost of transport of the product or parts to and from the service agent
5. To make a claim under this warranty, you must produce the original invoice or other purchase documentation as proof of the original purchase date. You must send your claim to Shriro Australia Pty Limited, 104 Vanessa Street, Kingsgrove, NSW, 2208, within 7 days of any alleged defect or failure of the product first becoming apparent. You are responsible for the expense of making a claim under this warranty.

*This warranty is given by:*

Shriro Australia Pty Ltd, ABN: 28 002 386 129  
Telephone: 1800 648 556  
Facsimile: 1800 628 577  
Email: [customercare@robinhood.com.au](mailto:customercare@robinhood.com.au)  
[www.robinhood.com.au](http://www.robinhood.com.au)  
Attention: Customer Services Manager

## Warranty exclusions

1. The warranty does not apply where, in Shriro's opinion:
  - The defect is caused by misuse, wear and tear, dirt, fire or accidental damage. The product has been repaired or serviced by an unauthorised person.
  - The product was not installed in accordance with our instructions.
  - The product was purchased overseas or was not designed for use in Australia.
  - The product was not used, cleaned or cared for in accordance with our instructions.
  - The product was used outdoors.
2. All Robinhood Rangehoods are suitable for indoor use only and not suitable over BBQs or charcoal cookers designed for outdoor use.
3. In addition, this warranty does not extend to damage or defects which in our opinion, directly or indirectly arise from or are due to: exposing the product to acidic or corrosive materials or chemicals such as dyes, solvents, denture cleaner or acetone; using inappropriate household cleaning products such as abrasive cream or powder cleansers, furniture polish, bleach, mentholated spirits, drain cleaners, sugar soap, metal pads and strongly alkaline or acidic cleaners; heat damage, including from washing the product at high temperatures; impact or mishandling the product, including the impact caused by objects scraped along, thrown or dropped on the product surface or excessive weight being placed on the product; structural or support changes in or affecting the building or the application where the product has been installed; failure to clean or maintain the product as recommended; or any other causes specified in the product information as being excluded from this warranty.
4. Variations with the colour or gloss within the product or any ageing or fading of colour, shine or gloss level over time are not covered by this warranty. The warranty does not cover visual imperfections or blemishes in the surface and edges of the product that were not brought to your supplier's attention at the time you inspected the product.
5. We will not be responsible under this warranty for, nor pay the costs of, removing the existing product, or reinstalling the new product, or any associated costs or damages.
6. Charcoal filters and light bulbs are not covered by this warranty.

The benefits given by this warranty are in addition to other rights and remedies of consumers under any law in relation to the goods which cannot be excluded.

This warranty certificate is not intended to create a contract between Shriro Australia Pty Limited and the purchaser.

New Zealand  
Monaco Corporation Ltd Telephone:  
(09) 415 6000  
Facsimile: (09) 415 7400  
Email: [enquiries@robinhood.co.nz](mailto:enquiries@robinhood.co.nz)  
[www.robinhood.co.nz](http://www.robinhood.co.nz)

Australia  
Shriro Australia Pty Limited  
ABN 28 002 386 129  
Telephone: 1800 648 556  
Facsimile: 1800 628 577  
Email: [enquiries@robinhood.com.au](mailto:enquiries@robinhood.com.au)  
[www.robinhood.com.au](http://www.robinhood.com.au)