

Description: **ROBINHOOD CONDENSER DRYER 7KG WHITE**

Model Number: **RHCD7WN**

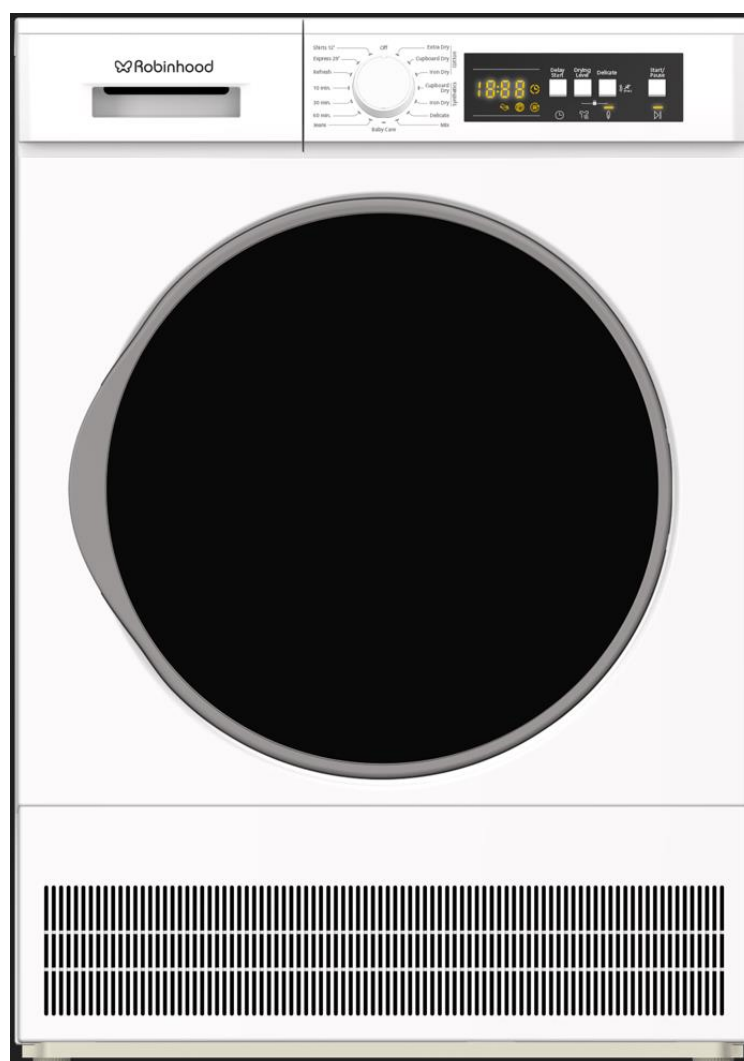

Model pictured: RHCD7WN

Actual unit may vary from picture as above

Contents

Congratulations!

Thank you for choosing one of our appliances. Before you use the appliance, we strongly recommend that you read through the whole user manual which provides important safety instructions and description of the product and the proper use of its functions.

To avoid the ever-present risks involved with using an electrical appliance it is vital that the oven is installed correctly and that you read the safety instructions carefully to avoid misuse and hazards. It is important that you retain these instructions and your proof of purchase along with any other important documents about this product for future reference.

Due to continual product development, Robinhood reserves the right to alter specifications or appearances without notice.

Important Safety Instructions	1
Appliance details	4
Installation Instructions	5
Operation Instructions	7
Cleaning and Maintenance	14
Troubleshooting	16
Troubleshooting	17
Warranty Certificate (New Zealand)	18
Warranty Certificate (Australia)	19

Disposal Information

- Most of the packing materials are recyclable. Please dispose of these materials through your local recycling depot or by placing them in appropriate collection containers.
- If you wish to discard this product, please contact your local authorities and ask for the correct method of disposal.

Important Safety Instructions

PRIMARY CONSIDERATIONS

- Children of less than 3 years should be kept away unless continuously supervised.
- This tumble dryer is intended only for household and indoor use. The warranty will be void in case of commercial use.
- Use this product only for laundry with a label that indicates it is suitable for drying.
- The manufacturer will not accept responsibility for damages resulting from incorrect use or transport.
- Do not allow floor coverings to obstruct the ventilation openings.
- Installation and repair of the machine should only be made by an authorized repair agent.
- The manufacturer cannot be held responsible for damages resulting from un-authorized repairs.



WARNING: Never spray or pour water onto the dryer to wash it! There is risk of electric shock!

- Leave at least 3 cm of space between the side and rear walls of the product and above if you plan on placing your appliance under a worktop.
- Assembly / disassembly for under-counter installation, if necessary, must be done by an authorized service agent.
- Before installation, check the product for visible damage. Never install or operate a damaged product.
- Keep pets away from the dryer.
- Fabric softeners, or similar products, should be used in accordance with the manufacturer's instructions.
- Remove all objects from pockets such as lighters and matches.
- The appliance must not be installed behind a lockable door, a sliding door or a door with a hinge on the opposite side to that of the tumble dryer if it prevents the door from being fully opened.

SAFETY INSTRUCTIONS

This section contains safety instructions that will help protect you from risk of personal injury or property damage. Failure to follow these instructions will void any warranty.

Electrical Safety

- The appliance must not be supplied through an external switching device, such as a timer, or connected to a circuit that is regularly switched on and off by a utility.
- Do not touch the power plug with wet hands. Always pull the plug to unplug the product, otherwise, there will be risk of an electric shock.
- Connect the dryer to a grounded socket with fuse protection. Have the earth connection installed by a qualified electrician. Our company cannot be held responsible for damages/losses resulting from using the dryer without an earth connection as required by local regulations.
- The input voltage and wattage are indicated on the rating plate.
- Voltage and frequency values indicated on the rating plate must be equal to the mains voltage and frequency value in your house.
- Unplug the dryer when it is not used for an extended period, and before installation, maintenance, cleaning and repair, otherwise, the dryer may get damaged.
- The plug socket must be freely accessible at all times after installation.

 A damaged power cord/plug can cause fire or give you an electric shock. When damaged it must be replaced, this should only be done by qualified personnel.

 To avoid the risk of fire or electric shock, do not use extension cords, multi sockets or adapters to connect the dryer to mains power.

Important Safety Instructions

CHILDREN'S SAFETY

- This appliance is not intended for use by persons (including children) with reduced physical, sensory or mental capabilities, or lack of experience and knowledge unless they have been given supervision or instruction concerning use of the appliance by a person responsible for their safety.
- Children must not play with the appliance. Cleaning and user maintenance must not be made by children without supervision.
- Do not leave children unattended near the machine.
- Children might lock themselves in the machine resulting in risk of death.
- Do not allow children to touch the glass door during operation. The surface becomes extremely hot and may cause skin damage.
- Keep packaging material away from children.
- Poisoning and irritation may occur if detergent and cleaning materials are consumed or come into contact with the skin and eyes.
- Keep cleaning materials out of the reach of children. Electrical products are dangerous for children.
- Keep children away from the product while it is running.
- To prevent children from interrupting the dryer cycle, you can use the child lock to avoid any changes in the running Program.
- Do not allow children to sit/climb on or climb inside the product.

PRODUCT SAFETY



Due to risk of fire, the following laundry items and products should NEVER be dried in the dryer:

- Do not dry unwashed items in the tumble dryer.
- Items that have been soiled with substances such as cooking oil, acetone, alcohol, petrol, kerosene, spot removers, turpentine, waxes and wax removers should be washed in hot water with an extra amount of detergent before being dried in the tumble dryer.
- Cleaning cloths and mats that have residues of flammable cleaning agents or acetone, gas, petrol, stain remover, turpentine, candle, wax, wax remover or chemicals.
- Laundry that has residues of hair sprays, nail polish remover and similar substances.
- Laundry on which industrial chemicals have been used for cleaning (such as chemical cleaning).
- Laundry that has any kind of foam, sponge, rubber or rubber-like parts or accessories. These include latex foam sponge, shower caps, waterproof fabrics, fitted clothes and foam pillows.
- Items with filling and damaged items (pillows or jackets). Foam protruding from these items might catch fire during the drying process.
- Operating the dryer in environments that contain flour or coal dust may cause explosion.



ATTENTION: Underwear that contains metal reinforcements should not be put in the dryer. The dryer may be damaged if metal reinforcements come loose and break off during drying.

CORRECT USE



ATTENTION: Never stop a tumble dryer before the end of the drying cycle unless all items are quickly removed and spread out so that the heat is dissipated.



ATTENTION: Make sure that pets do not enter the dryer. Check the inside of the dryer before using it.



ATTENTION: Superheating of clothes inside of the dryer can occur if you cancel the Program or in the event of a power failure whilst the dryer is running. This concentration of heat can cause self-combustion so always activate the Refresh Program to cool down or quickly remove all laundry from the dryer in order to hang them up and dissipate the heat.

- Use the dryer only for household drying and to dry fabrics with a label that indicates they are suitable for drying. All other uses are out of the scope of intended use and are prohibited.
- The warranty will be void in case of any commercial use.
- This appliance is designed to be used inside domestic residences only and should be placed on a straight and stable surface.

Important Safety Instructions

- Do not lean against or sit on the door of the dryer. The dryer may tip over.
- To maintain a temperature that will not harm the laundry (e.g., to prevent the laundry from catching fire), a cooling process starts after the heating process. After this, the Program ends. At the end of the Program, always remove the laundry promptly.
- Oil Affected Items - Especially when exposed to heat sources such as in a tumble dryer. The items become warm, causing an oxidation reaction in the oil. Oxidations creates heat. If the heat cannot escape, the items can become hot enough to catch fire. Piling, stacking or storing oil-affected items can prevent heat from escaping and so create a fire hazard.
- If it is unavoidable that fabrics that contain vegetable or cooking oil or have been contaminated by hair care products be placed in a tumble dryer they should first be washed in hot water with extra detergent - this will reduce, but not eliminate, the hazard.

 **ATTENTION:** Never use the dryer without a lint filter or with a damaged lint filter.

- Lint filters must be cleaned after each use as indicated in Cleaning the Lint Filter.
- Lint filters must be dried after wet cleaning. Wet filters might cause malfunction during the drying process.
- Lint accumulation must not to be allowed around the tumble dryer (not applicable for appliances intended to be vented to the exterior of the building).

 **IMPORTANT:** The clearance between the dryer and the floor should not be reduced with objects such as carpets, wood or panel, otherwise, sufficient air intake cannot be ensured for the machine.

- Do not install the dryer in rooms where there is risk of freezing. Freezing temperatures negatively affect the dryer's performance. Condensation that freezes in the pump and hose may cause damage.

INSTALLING ON TOP OF A WASHING MACHINE

 **ATTENTION:** A washing machine cannot be placed on the dryer. Pay attention to the warnings below when installing the dryer on a washing machine.

 **ATTENTION:** The dryer can only be placed on washing machines that have a same capacity and above.

- To use the dryer on the washing machine, a fixing part must be used between the two products. The fixing part must be attached by an Authorized Service Provider.
- When the dryer is placed on the washing machine, the total weight of these products may reach almost 150 kilograms (when loaded). Place the products on a solid floor that has a load bearing capacity!

Appropriate Installation Table for Washing Machine and Tumble Dryer					
Tumble Dryer (Depth)	Washing Machine				
	37-41 cm	42-45 cm	46-49 cm	50-56 cm	57-63 cm
52,5 cm	X	✓	✓	✓	✓
56 cm	X	X	✓	✓	✓
61 cm	X	X	X	✓	✓
64 cm	X	X	X	X	✓

(For the depth information, please see Technical Specifications section)

In order to put the dryer machine onto the washing machine, a special stacking kit is required as an optional extra. Please contact customer service to acquire. The assembly instruction will be served together with the stacking kit.

Appliance details

TECHNICAL SPECIFICATION

Brand	Robinhood
Model	RHCD7WN
Height	Min: 845 mm / Max: 855 mm*
Width	596 mm
Depth	563 mm
Capacity (max.)	7 kg**
Net weight (with glass door)	37.5 kg
Voltage	220-240 V
Power	2200 W

*Min. height: Height with the adjustable feet not used. Max. height: Height with the adjustable feet extended to the maximum.

**Dry laundry weight before washing.

 **IMPORTANT:** To improve the quality of the dryer, technical specifications are subject to change without prior notice.

 **IMPORTANT:** The values declared have been obtained in a laboratory environment according to the relevant standards. These values may change depending on the environmental conditions and use of the dryer.

OVERVIEW

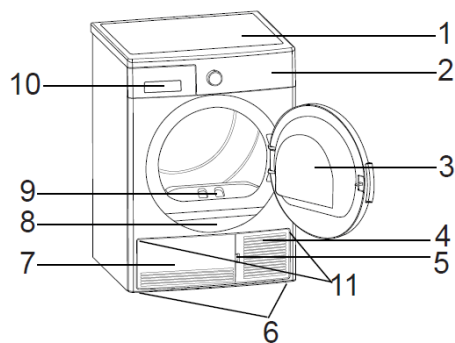

- | | |
|------------------------|------------------------|
| 1. Upper Tray | 7. Plinth cover |
| 2. Control Panel | 8. Rating plate |
| 3. Loading door | 9. Lint filter |
| 4. Plinth opening slot | 10. Drawer cover |
| 5. Plinth | 11. Ventilation grills |
| 6. Adjustable feet | |

Installation Instructions

- Before contacting the local Authorized Service Provider for the installation of the dryer, check the information in the user manual to make sure that the electrical installation and water outlet is suitable. If they are not, call a qualified electrician and a plumber to have the necessary adjustments made.
- It is the customer's responsibility to prepare the dryer's installation place, as well as the electricity and waste water installation. Before installation, check the dryer for damage. If damaged, do not have it installed. Damaged products may endanger your health.
- Install the dryer on a stable and flat surface.
- Run the dryer in a dust-free environment where the air ventilation is good.
- The clearance between the dryer and the floor should not be reduced with objects such as carpets, wood or tape.
- Do not block the ventilation grills found on the plinth of the tumble dryer.
- The appliance must not be installed behind a lockable door, a sliding door or a door with a hinge on the opposite side of the tumble dryer, in such a way that blocks the full opening of the tumble dryer door.
- Once the dryer has been installed, the connections must remain stable. When installing the dryer, make sure that the rear surface is not leaning on anything (e.g., tap, socket).
- The operating temperature of the dryer is +5°C to +35°C. If operated out of this temperature range, the performance of the dryer will be affected negatively and the product will be damaged.
- Be careful when carrying the product since it is heavy. Always wear safety gloves.
- Always install the product should be placed against a wall.
- The rear surface of the product should be placed against the wall.
- When the product is placed on a stable surface, use a water level to check if it is fully stable. If not, adjust the feet until it becomes steady. Repeat this process every time you relocate the product.
- Do not place the dryer onto the power cable.

Removing the Safety Assembly

- Open the loading door.
- Hold the nylon that contains the Styrofoam part and is found in the drum.
- Pull the nylon towards you and remove the transport safety assembly.
- Make sure that there is no part of the transport safety assembly left in the drum.

Connection to Water Outlet (with optional drain hose)

In products with a condenser unit, water accumulates in the water tank during the drying process. You must empty the accumulated water after each drying process. Instead of periodically emptying the water tank, you can also use the water drain hose provided with the product to directly drain the water outside.

Connecting the Water Discharge Hose

1. Pull and take out the end of the hose at the back of the dryer. Do not use any tools to take out the hose.
2. Fit one end of the water discharge hose, which is provided with the product, to the slot from which you have removed the hose.
3. Fix the other end of the water discharge hose directly to the water outlet or sink.

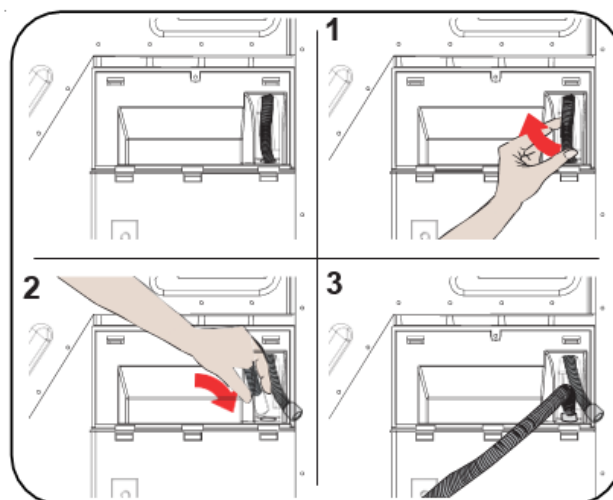

Installation Instructions

 **ATTENTION:** The hose must be connected in a manner that it cannot be displaced. If the hose comes out during water discharge, there might be flooding in your house.

 **IMPORTANT:** The water discharge hose must be installed at a height of 80 cm maximum.

 **IMPORTANT:** The water discharge hose must not be bent between the outlet and the product, folded or stepped over.

Adjusting the Feet

- For the dryer to work with less noise and vibration, it must be stable and balanced on its feet. Adjust the feet to ensure that the product is balanced.
- Rotate the feet to the right and to the left until the dryer is even and stable.

 **IMPORTANT:** Never remove the adjustable feet.

Electrical Connection

 **ATTENTION:** There is risk of fire and electric shock.

- Your dryer is set to 220-240 V and 50 Hz.
- The mains plug and cable of the dryer is equipped with an earthing pin. This plug must be connected to an earthed socket. Consult a qualified electrician if you do not have such an outlet.
- Our company cannot be held responsible for damages resulting from usage without earthing.

 **IMPORTANT:** Operating your machine at low voltage values will shorten the service life and decrease the performance of your machine.

Under Counter Installation

- Leave at least 3 cm of space between the side and rear walls of the product and the underside of the worktop when installing your product under a counter.
- Assembly / disassembly under the counter, if necessary, must be done by authorized service.

















Operation Instructions

PREPARING THE LAUNDRY

Sorting the Laundry to be Dried

Follow the instructions on the labels of the laundry to be dried. Only dry items that have a statement/symbol that indicates "they can be dried in a dryer".

- Do not operate the product with load amounts and laundry types other than those given in 4.3. Load Capacity.

 Suitable for drying in a dryer	 Does not need ironing	 Sensitive/Delicate drying	 Not suitable for drying in a dryer
 No drying	 Do not dry-clean	 At any temperature	 At high temperatures
 At medium temperatures	 At low temperatures	 Heatless	 Hang to dry
 Spread to dry	 Hang wet to dry	 Spread in shadow to dry	 Suitable for dry cleaning

Do not dry thin, multi-layer or thick-layer fabrics together as they dry at different levels. For this reason, dry clothes together that have the same structure and fabric type. This way, you can get an even drying result. If you think that the laundry is still wet, you can select a time Program for additional drying.

Please dry your big (like duvets) and small sizes of laundries separately to avoid damp laundry.

 **IMPORTANT:** Delicate fabrics, embroider fabrics, woolen/silk fabrics, clothes made of delicate and expensive fabrics, airtight clothes and tulle curtains are not suitable for drying in the dryer.

Operation Instructions

Preparing the Laundry to be Dried



Risk of explosion and fire!

Remove all objects from pockets such as lighters and matches.



ATTENTION: The drum of the dryer and the fabrics may get damaged.

- The clothes may have become entangled during the washing process. Separate them from each other before placing them in the dryer.
- Remove all objects in the pockets of the clothes and apply the following:
- Tie fabric belts, apron laces etc. to each other or use a laundry bag.
- Lock the zips, clasps and fasteners, do up the buttons of covers.
- To get the best drying result, sort the laundry according to the textile type and drying program.
- Remove clips and similar metal parts from the clothes.
- Woven goods such as t-shirts and knit clothes generally shrink in the first drying. Use a protective Program.
- Do not over-dry synthetics. This will cause creases.
- When washing the laundry to be dried, adjust the amount of softener according to the data from the manufacturer of the washing machine.

Load Capacity

Maximum dry load is 7kg. Do not load the product with more laundry than the maximum capacity.



IMPORTANT: It is not recommended to load the dryer with more laundry than the amount shown in the figure. When overloaded, the drying performance of the dryer will decrease and the dryer and laundry might be damaged.

Operation Instructions

USING THE TUMBLE DRYER

Control Panel

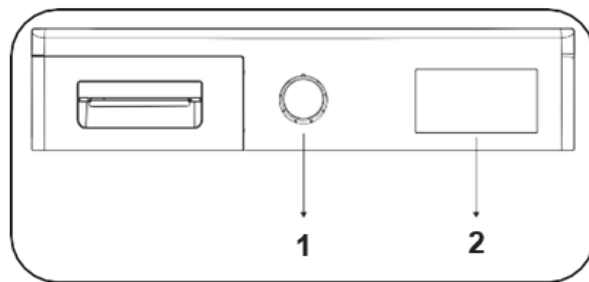

- 1- Program Selection Knob
- 2- Electronic indicator and additional functions

Program Selection Knob

Use the Program selection knob to select the desired drying Program.

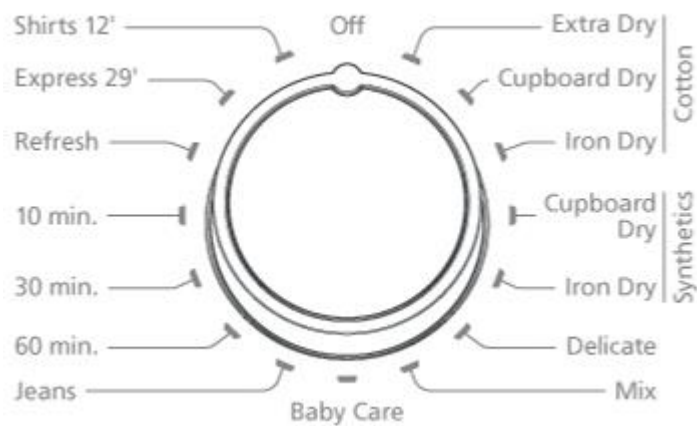

Electronic Indicator and Additional Functions

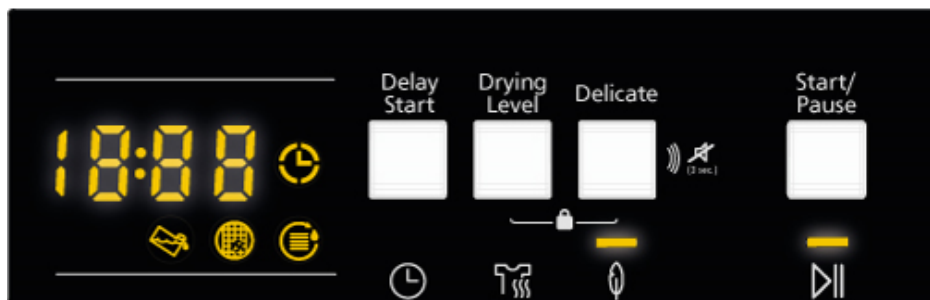

Display symbols:

Water tank warning indicator	
Lint filter cleaning warning indicator	
Condenser cleaning warning indicator	

Operation Instructions

Program Selection and Consumption Table

Press the Start/Pause button to start the Program. The Start/Pause LED that indicates that the Program has started and the Drying LED will come on.

Program	Load (kg)	Washing machine spin speed	Approximate amount of remaining humidity	Duration (minutes)
Cotton Extra Dry	7	1000	60%	135
Cotton Cupboard Dry	7	1000	60%	128
Cotton Iron Dry	7	1000	60%	110
Synthetics CupboardDry	3,5	800	40%	53
Synthetics Iron Dry	3,5	800	40%	40
Delicate	2	600	50%	44
Mix	4	1000	60%	90
Baby Care	3	1000	60%	78
Jeans	4	1000	60%	93
60 min	-	-	-	60
30 min	-	-	-	30
10 min	-	-	-	10
Refresh	-	-	-	10
Express 29'	1	1200	50%	29
Shirts 12'	0.5	1200	50%	12

Energy consumption values			
Program	Load (kg)	Energy Consumption Value (kWh/year)	Energy Rating Star
"Cotton Cupboard Dry Drying Level 3"	7	295	2

*Energy labelling standard Program (AS/NZS 2442)

All the filters must be cleaned before test series.

All values in the table were determined in accordance with standard laboratory conditions. Consumption values may vary from the values in the table depending on the fabric type, spin speed, environment conditions and voltage values.

Operation Instructions

Auxiliary Functions

The table that summarizes the options that can be selected in Program is given below:

Option	Description
Drying Level	The humidity level obtained after drying can be increased by 3 levels. This way, level of required dryness can be selected. The levels that can be selected other than the standard setting: 1, 2, 3. After selection, the LED of the relevant drying level will turn on.
Delicate	Delicate fabrics are dried for a longer time at a low temperature.
Delayed Start	You can delay the start time of the Program by selecting the 1-hour to 23-hour option. You can activate the desired delay time by pressing the Start/Pause button. When the time is up, the selected Program will start automatically. During the delay time, options compatible with the Program can be activated/deactivated. Long pressing on Delayed Start button changes delay time continuously.
Buzzer Cancel	The dryer gives an audible warning when program selection knob is turned, buttons are pressed and at the end of Program. To cancel the warnings, press and hold the "Anti-Crease Option" button for 3 seconds. When you press the button, you will hear an audible warning that the option has been cancelled.
Child Lock	There is a child lock option to avoid changes in the Program flow when keys are pressed during the Program. To activate child lock feature user should press "Drying level" and "Delicate" buttons simultaneously for 3 sec. When the child lock activated, all keys will be deactivated. Child lock is not automatically deactivated at the end of the program. To deactivate child lock at end of the Program, set the Program selection knob to "Off" position. Then Program selection knob to first position. Child lock is still active. To deactivate child lock, user should press "Drying level" and "Delicate" buttons simultaneously for 3 sec. When activating/deactivating the child lock, "CL" will visualize on display for 2 sec and then becomes off; and an audible warning will be heard. Warning: When the product is running or the child lock is active, if you turn the Program selection knob, you will hear an audible warning and "CL" will visualize on display for 2 sec and then becomes off. If you turn the Program selection knob, you will hear an audible warning. Even if you set the Program knob to another Program, the previous Program will continue running. To select a new Program, you need to deactivate the child lock and then set the Program selection knob.

Operation Instructions

Starting the Program

The Start/Pause LED will flash during Program selection. Press the Start/Pause button to start the Program. The Start/Pause LED that indicates that the Program has started and the drying LED will come on.

Program	Description
Cotton Extra Dry	This Program dries thick and multi-layer fabrics, such as cotton towels, bedsheets, pillowcases, bathrobes, at a high temperature to allow you to place them in a closet.
Cotton Cupboard Dry	This Program dries cotton pajamas, underwear, tablecloths etc. to allow you to place them in a closet.
Cotton Iron Dry	This Program dries cotton laundry to prepare it for ironing. Laundry removed from the machine will be damp.
Synthetics Cupboard Dry	This Program dries synthetics, such as shirts, t-shirts, blouses, at a lower temperature compared to the cottons Program to allow you to place them in a closet.
Synthetics Iron Dry	This Program dries synthetics, such as shirts, t-shirts, blouses, at a lower temperature compared to the cottons Program to prepare them for ironing. Laundry removed from the machine will be damp.
Delicate	This Program dries thin clothes like shirts, blouses and silk garments at a low temperature to make them ready to wear.
Mix	To reach the required drying level at a low temperature, you can use the time Programs of 10 min. to 180 min. Regardless of the drying level, the Program stops at the desired time.
Baby Care	This Program dries delicate infant clothes at a low temperature to make them ready to wear.
Jeans	This Program is used to dry jeans.
Time Program	To reach the required drying level at a low temperature, you can use the timed Programs of 10 min., 30 min., and 60 min. Regardless of the drying level, the Program stops at the desired time.
Refresh	This Program provides ventilation for 10 minutes without applying heat to help freshen up your garments.
Express 29'	1 kg of cotton shirts spun at a high speed in the washing machine are dried in 29 minutes.
Shirts 12'	2 to 3 shirts are ready for to be ironed in 12 minutes.

 **IMPORTANT:** Do not open the loading door while the Program is running. If you have to open the door, do not keep it open for a long time.

Selection Stand By

After 15 minutes without user action in selection mode, machine goes to energy- saving mode due to decrease energy consumption. In this model, "-- --" must blink with 0,5 sec ON, 3 sec OFF during energy-saving mode. At the energy saving mode, "-- --" led luminosity is reduced. To restart the machine, it will be necessary to move selector to OFF and select again the program.

PROGRAM PROGRESS

During the Program

If you open the door when the Program is running, the product will switch to standby mode. Once the door has been closed, press the Start/Pause key to resume the Program.

Do not open the loading door when the Program is running. If you have to open the door, do not keep it open for a long time.

Operation Instructions

Program End

Once the Program is over, the warning LEDs for Start/Pause, water tank level, filter cleaning and condenser cleaning will turn on. Additionally, an audible warning will be given at the end of the Program. You can remove the laundry to make the machine ready for a new load.

 **IMPORTANT:** Clean the lint filter after every Program. Empty the water tank after every Program.

 **IMPORTANT:** If you do not take out the laundry after the Program has ended, the 1-hour Anti Crease phase will automatically be activated. This Program rotates the drum at regular intervals to prevent creases.

Drum Light Information

- This product includes LED Drum Light.
- The light works automatically when you open the door. And closes itself after a while automatically.
- It is not an adjustable option for user to open or close it.
- Please do not try to replace or modify the LED Light.

PROGRAMS	OPTIONS				
	Delay Start	Buzzer Cancel	Child Lock	Drying Level	Delicate
Cotton Extra Dry	✓	✓	✓	✓	✓
Cotton Cupboard Dry	✓	✓	✓	✓	✓
Cotton Iron Dry	✓	✓	✓	✓	✓
Synthetics CupboardDry	✓	✓	✓	✓	✓
Synthetics Iron Dry	✓	✓	✓	✓	✓
Delicate	✓	✓	✓	X	✓
Mix	✓	✓	✓	✓	✓
Baby Care	✓	✓	✓	✓	✓
Jeans	✓	✓	✓	✓	✓
60 min	✓	✓	✓	X	X
30 min	✓	✓	✓	X	X
10 min	✓	✓	✓	X	X
Refresh	✓	✓	✓	X	X
Express 29'	✓	✓	✓	X	X
Shirts 12'	✓	✓	✓	X	X
X	Not selectable				
✓					

 **IMPORTANT:** Do not open the loading door while the Program is running. If you have to open the door, do not keep it open for a long time.

Cleaning and Maintenance

IMPORTANT: Do not use industrial chemicals to clean your dryer. Do not use a dryer that has been cleaned with industrial chemicals.

Cleaning the Lint Filter

IMPORTANT: DO NOT FORGET TO CLEAN THE LINT FILTER AFTER EACH USE.

To clean the lint filter:

1. Open the loading door.
2. Pull up the lint filter to remove it.
3. Use your hands or a soft cloth to clean the lint.
4. Close and refit the lint filter.

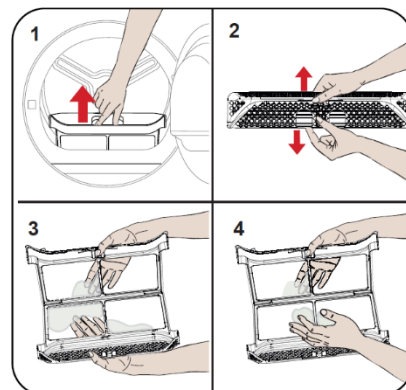

After the dryer has been used for a certain period of time, if you encounter a layer that will cause obstruction on the filter surface, wash the filter with warm water to clean the layer. Dry the filter thoroughly before reinstalling it again.

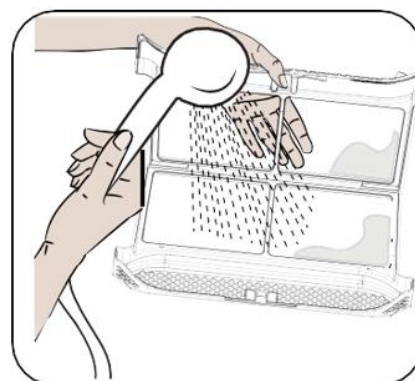

Emptying the Water Tank

1. Pull the drawer cover and carefully take out the tank.
2. Empty the water in the tank.
3. If there is lint accumulated on the discharge cap in the tank, clean it with water.
4. Refit the water tank.

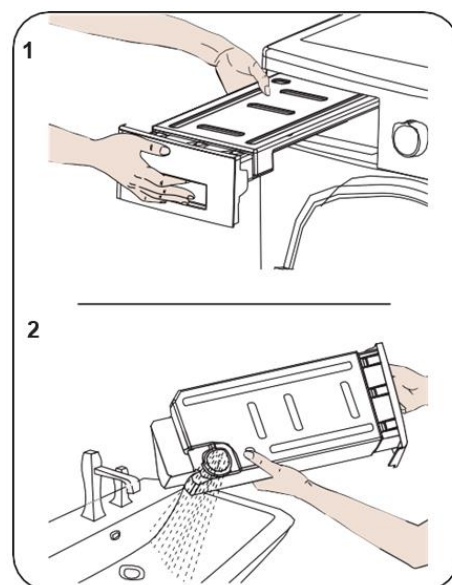

IMPORTANT: Never remove the water tank when the Program is running. The water condensed in the water tank is not suitable for human consumption.

IMPORTANT: Do not forget to empty the water tank after each use.

Cleaning and Maintenance

Cleaning the Condenser

IMPORTANT: Clean the condenser when you see the warning "Condenser Cleaning".

IMPORTANT: Even if the "condenser cleaning warning led" is not on: clean the condenser after every 30 drying processes or once a month.

If the drying process is completed, open the loading door and wait for it to cool down.

1. Open the plinth and release the 2 cover locks of the condenser.
2. Hold the condenser by the plastic part and pull it out.
3. Clean it with a showerhead and wait for the water to drain off.
4. Fully insert the condenser into its seat and lock the 2 locks.
5. Close the plinth cover

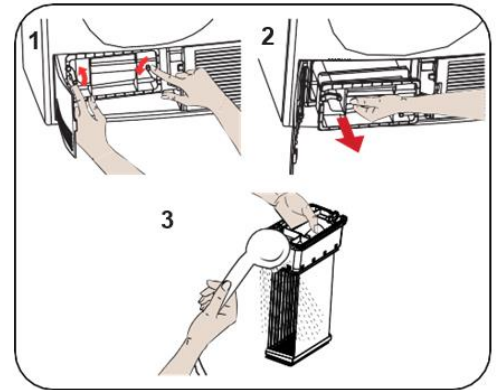

Cleaning the Humidity Sensor

Inside the machine, there are humidity sensors that detect whether the laundry is dry or not.

To clean the sensors:

1. Open the loading door of the machine.
2. If the machine is still hot due to the drying process, wait for it to cool down.
3. Using a soft cloth soaked in vinegar, wipe the metal surfaces of the sensor and dry them.

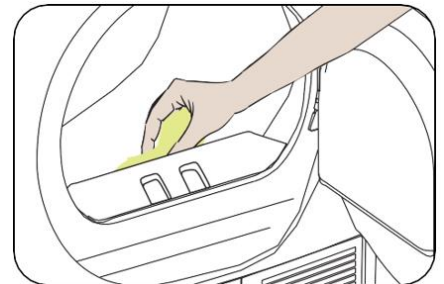

IMPORTANT: Clean the metal surfaces of the sensor 4 times a year.

IMPORTANT: Do not use metal tools to clean the metal surfaces of the sensor.

WARNING: Due to the risk of fire and explosion, do not use solution agents, cleaning agents or similar products when cleaning the sensors.

Cleaning the Inner Surface of the Loading Door

IMPORTANT: Do not forget to clean the inner surface of the loading door after each drying process.

Open the loading door of the dryer and clean all of the inner surfaces and the gasket with a soft, damp cloth.

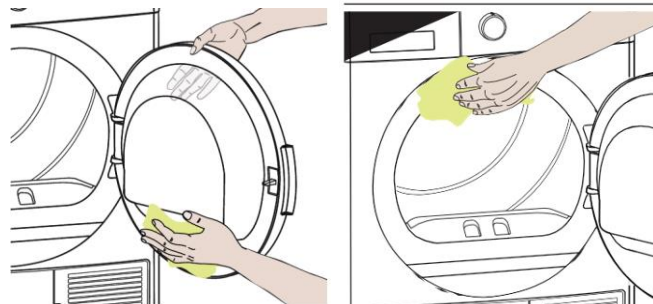

Troubleshooting

Your dryer is fitted with systems that continuously perform checks during the drying process to take the necessary measures and warn you in case of any malfunction.

 **WARNING:** If the problem persists even if you have applied the steps in this section, please contact your dealer or an Authorized Service Provider. Never try to repair a nonfunctional product.

PROBLEM	REASON	SOLUTION
The drying process takes a long time.	The surface of the lint filter might be clogged.	Wash the filter with lukewarm water.
	The condenser might be clogged.	Clean the condenser.
	The ventilation grills in front of the machine might be closed.	Open the doors/windows to prevent the room temperature from rising too much.
	There might be a layer of limescale on the humidity sensor.	Clean the humidity sensor.
	The dryer might be overloaded with laundry.	Do not overload the dryer.
	The laundry might be insufficiently spun.	Select a higher spin speed on your washing machine.
Laundry comes out damp at the end of the drying process.	 The laundry that comes out hot at the end of the drying process generally feels more humid.	
	The Program used might not be suitable for the type of laundry.	Check the care labels on the laundry items, select a suitable Program for the type of laundry and additionally, use the time Program.
	The surface of the lint filter might be clogged.	Wash the filter with lukewarm water.
	The condenser might be clogged.	Clean the condenser.
	The dryer might be overloaded with laundry.	Do not overload the dryer.
	The laundry might be insufficiently spun.	Select a higher spin speed on your washing machine.
The dryer cannot be opened or the Program cannot be started. The dryer does not get activated when adjusted.	The dryer might not be plugged in.	Make sure that the plug is fitted in the socket.
	The loading door might be open.	Make sure that the loading door is properly closed.
	You might not have set a Program or pressed the Start/Pause key.	Make sure that the Program has been set and the dryer is not in the Standby (Pause) mode.
	Child lock might be active.	Deactivate the child lock.
The Program has been interrupted for no reason.	The loading door might not be closed properly.	Make sure that the loading door is properly closed.
	There might have been a power failure.	Press the Start/Pause key to start the Program.
	The water tank might be full.	Empty the water tank.

Troubleshooting

PROBLEM	REASON	SOLUTION
Clothes have shrunk, felted or deteriorated.	The Program used might not be suitable for the type of laundry.	Check the care labels on the laundry items, select a suitable Program for the type of laundry.
Water leaking from the loading door.	There might be lint accumulated on the inner surfaces of the loading door and on the surfaces of the gasket of the loading door.	Clean the inner surfaces of the loading door and the surfaces of the gasket of the loading door.
The loading door opens on its own.	The loading door might not be closed properly.	Push the loading door until you hear the closing sound.
The water tank warning symbol is on/flashing.	The water tank might be full.	Empty the water tank.
	The water discharge hose might be bent.	If the product is connected directly to the water outlet, check the water discharge hose.
The condenser cleaning warning symbol is on.	The condenser might be unclean.	Clean the condenser.
The filter cleaning warning symbol is on.	The lint filter might be unclean.	Clean the filter.
	The filter seat might be clogged by lint.	Clean the filter seat.
	There might be a layer that causes obstruction on the surface of the lint filter.	Wash the filter with lukewarm water.
The program cannot be started and the filter warning led is blinking	The filter seat might be clogged by lint.	Clean the filter seat.
	There might be a layer that causes obstruction on the surface of the lint filter.	Wash the filter with lukewarm water.
	The condenser may not be placed.	Replace the condenser.
The program cannot be started and both condenser and filter warning led are blinking	The condenser and filter may not be placed.	Replace the filter and condenser.
	The filter and condenser warning led are blinking even though the filter and condenser are placed.	Call technical service.

Automatic fault warnings and what to do

Your tumble dryer is equipped with a built-in fault detection system, indicated by a combination of flashing operation lights. The most common failure codes are shown below.

ERROR CODE	SOLUTION
E03 / 	Empty the water tank, if problem does not solve, contact the nearest authorized service agent.
E04	Contact the nearest authorized service agent.
E05	Contact the nearest authorized service agent.
E06	Contact the nearest authorized service agent.
E08	There may be voltage fluctuation in mains. Wait until voltage is appropriate for working range.

Warranty Certificate (New Zealand)

Terms and Conditions

The following conditions apply in respect of the warranty given in this certificate:

1. Monaco Corporation Limited ("Monaco") warrants the following Robinhood products against manufacturing defects and faulty materials, under normal use and subject to the exclusions in this certificate, for a period of:
 - Rangehood, Ovens, Cooktops, Dishwashers, Refrigeration - 24 months from date of original purchase for domestic use.
 - Uniduct - 12 months from date of original purchase for domestic use.
 - Ironing centre - 12 months from date of original purchase for domestic use.
 - Sinks sets- 5 years on stainless steel sink including draining bench from date of original purchase for domestic use, 6 months on all stainless steel accessories, including wire rack, colander and tray from date of original purchase for domestic use.
 - Laundry Tub - 5 years on stainless bowl, 24 months on Tap, Cabinet and other components from the date of original purchase for domestic use.

"Original purchase", when used in this certificate, means purchase by the customer directly from Monaco or one of its approved suppliers.

2. This warranty is limited to the repair or replacement, at our option, within the warranty period of any component part which we at our discretion determine to contain faulty materials or a manufacturing defect in breach of this warranty. This warranty is subject to terms and conditions set out in this certificate.
3. The warranty only applies within New Zealand.
4. The customer must produce the original invoice or other purchase documentation as proof of the original purchase date.

Warranty exclusions

1. The warranty does not apply where, in Monaco's opinion:
 - The defect is caused by misuse, wear and tear, dirt, fire or accidental damage. The product has been repaired or serviced by an unauthorised person.
 - The product was not installed in accordance with our instructions.
 - The product was purchased overseas or was not designed for use in New Zealand. The product was not used, cleaned or cared for in accordance with our instructions.
 - The product was used outdoors.
2. In addition, this warranty does not extend to damage or defects which in our opinion, directly or indirectly arise from or are due to:
 - Exposing the product to acidic or corrosive materials or chemicals such as dyes, solvents, denture cleaner or acetone; Using inappropriate household cleaning products such as abrasive cream or powder cleansers, furniture polish, bleach, mentholated spirits, drain cleaners, sugar soap, metal pads and strongly alkaline or acidic cleaners;
 - Heat damage, including from washing the product at high temperatures;
 - Impact or mishandling the product, including the impact caused by objects scraped along, thrown or dropped on the product surface or excessive weight being placed on the product;
 - Structural or support changes in or affecting the building or the application where the product has been installed;
 - Failure to clean or maintain the product as recommended; or any other causes specified in the product information as being excluded from this warranty.
3. Variations with the colour or gloss within the product or any ageing or fading of colour, shine or gloss level over time are not covered by this warranty. The warranty does not cover visual imperfections or blemishes in the surface and edges of the product that were not brought to your supplier's attention at the time you inspected the product.
4. Costs incurred on installation or removal of a product, or any reinstallation of a product, or any associated costs, are not covered by this warranty.
5. Monaco will not be liable for consequential or indirect loss or damage whatsoever and however arising out of or in connection with the supply, performance or removal of the product, including (but not limited to) loss of profit, loss of revenue, loss of contract, loss of goodwill or increased cost of workings, even if due to the negligence of Monaco or any of its approved suppliers, employees or agents.
6. Charcoal filters and light bulbs are not covered by this warranty
7. This warranty and the statements contained in this certificate or other documents given to you do not exclude, restrict or modify the application of any term implied into this warranty by statute, provided that (to the extent any statutory provision permits Monaco to limit its liability for a breach of an implied condition or warranty) Monaco's liability for such breach is limited to the payment of the cost of replacing the product, repairing the product or acquiring an equivalent product.
8. Subject to clause 5, our obligations under this warranty are limited to those set out in this certificate, and this warranty is expressly instead of all other warranties, express or implied, including any implied warranty of merchantability or fitness for a particular purpose and notwithstanding any course of dealing between the parties or custom and usage in trade to the contrary.

Terms and conditions are subject to change.

Warranty Certificate (Australia)

Terms and Conditions

If you are a consumer under the Australian Consumer Law, our goods come with guarantees that cannot be excluded under the Australian Consumer Law. You are entitled to a replacement or refund for a major failure and for compensation for any other reasonably foreseeable loss or damage. You are also entitled to have the goods repaired or replaced if the goods fail to be of acceptable quality and the failure does not amount to a major failure.

1. Shriro Australia Pty Limited ("Shriro") also warrants the following Robinhood products against manufacturing defects and faulty materials, under normal use and subject to the exclusions in this certificate, for a period of:
 - Rangehood, Ovens, Cooktops, Dishwashers, Refrigeration - 24 months from date of original purchase for domestic use.
 - Uniduct - 12 months from date of original purchase for domestic use.
 - Ironing centre - 12 months from date of original purchase for domestic use.
 - Sinks sets- 5 years on stainless steel sink including draining bench from date of original purchase for domestic use, 6 months on all stainless steel accessories, including wire rack, colander and tray from date of original purchase for domestic use.
 - Laundry Tub - 5 years on stainless bowl, 24 months on Tap, Cabinet and other components from the date of original purchase for domestic use. "Original purchase", when used in this certificate, means purchase by the customer directly from Shriro or one of its approved suppliers.
2. This warranty is limited to the repair or replacement, at our option, within the warranty period of any component part which we at our discretion determine to contain faulty materials or a manufacturing defect in breach of this warranty. This warranty is subject to terms and conditions set out in this certificate.
3. The warranty only applies within Australia.
4. For warranty service outside of capital city metropolitan area or 30 km from nearest authorised service agent you will be liable for reasonable travelling expenses and the cost of transport of the product or parts to and from the service agent
5. To make a claim under this warranty, you must produce the original invoice or other purchase documentation as proof of the original purchase date. You must send your claim to Shriro Australia Pty Limited, 2-34 Davidson Street, Chullora, NSW, 2190, within 7 days of any alleged defect or failure of the product first becoming apparent. You are responsible for the expense of making a claim under this warranty.

This warranty is given by:

Shriro Australia Pty Ltd, ABN: 28 002 386 129

Telephone: 1800 648 556

Facsimile: 1800 628 577

Email: customercare@robinhood.com.au

www.robinhood.com.au

Attention: Customer Services Manager

Warranty exclusions

1. The warranty does not apply where, in Shriro's opinion:
 - The defect is caused by misuse, wear and tear, dirt, fire or accidental damage. The product has been repaired or serviced by an unauthorised person.
 - The product was not installed in accordance with our instructions.
 - The product was purchased overseas or was not designed for use in Australia.
 - The product was not used, cleaned or cared for in accordance with our instructions.
 - The product was used outdoors.
2. All Robinhood Rangehoods are suitable for indoor use only and not suitable over BBQs or charcoal cookers designed for outdoor use.
3. In addition, this warranty does not extend to damage or defects which in our opinion, directly or indirectly arise from or are due to: exposing the product to acidic or corrosive materials or chemicals such as dyes, solvents, denture cleaner or acetone; using inappropriate household cleaning products such as abrasive cream or powder cleansers, furniture polish, bleach, mentholated spirits, drain cleaners, sugar soap, metal pads and strongly alkaline or acidic cleaners; heat damage, including from washing the product at high temperatures; impact or mishandling the product, including the impact caused by objects scraped along, thrown or dropped on the product surface or excessive weight being placed on the product; structural or support changes in or affecting the building or the application where the product has been installed; failure to clean or maintain the product as recommended; or any other causes specified in the product information as being excluded from this warranty.
4. Variations with the colour or gloss within the product or any ageing or fading of colour, shine or gloss level over time are not covered by this warranty. The warranty does not cover visual imperfections or blemishes in the surface and edges of the product that were not brought to your supplier's attention at the time you inspected the product.
5. We will not be responsible under this warranty for, nor pay the costs of, removing the existing product, or reinstalling the new product, or any associated costs or damages.
6. Charcoal filters and light bulbs are not covered by this warranty.

The benefits given by this warranty are in addition to other rights and remedies of consumers under any law in relation to the goods which cannot be excluded.

This warranty certificate is not intended to create a contract between Shriro Australia Pty Limited and the purchaser.

New Zealand
Monaco Corporation Ltd
Telephone: (09) 415 6000
Facsimile: (09) 415 7400
Email: enquiries@robinhood.co.nz
www.robinhood.co.nz

Australia
Shriro Australia Pty Limited
ABN 28 002 386 129
Telephone: 1800 648 556
Facsimile: 1800 628 577
Email: enquiries@robinhood.com.au
www.robinhood.com.au