

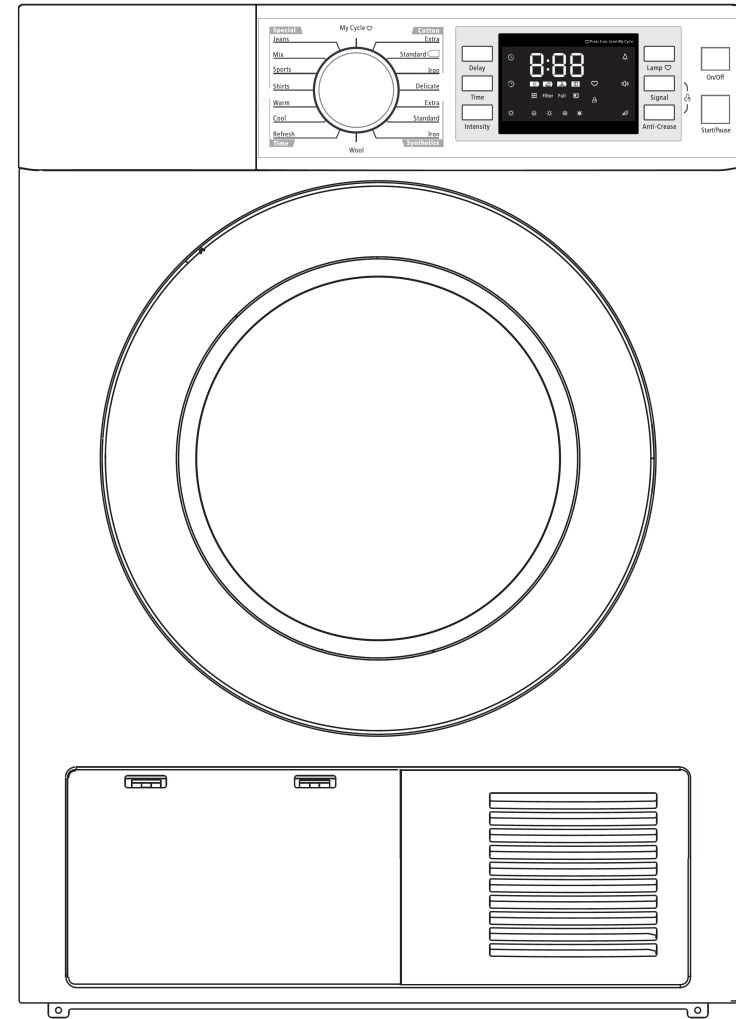











Description: **Robinhood Clothes Dryers**
Model Numbers: **RHHPD7W**



Safety information.....	1
Installation.....	6
Attention and advice.....	7
Part description.....	8
Description of controls.....	10
Operation instruction.....	12
Programme table.....	13
Specialty drying function.....	14
Cleaning and routine maintenance.....	16
Error codes, solutions and precautions.....	17
Technical specifications.....	18

Laundry Symbols

Before placing clothes in this dryer, check for laundry symbols which may indicate the suitability of using this appliance:

 Dry	 Normal	 Not tumble dry normal	 Do not dry
 Line dry / hang to dry	 Drip dry	 Dry flat	 In the shade
 Dry clean	 Do not dry clean	 Dry clean normal cycle with any solvent	 Dry clean normal cycle petroleum solvent only

Safety notes

 To prevent damage to your appliance and prevent personal injury, please read and follow the following safety information.

1. This appliance is not intended for use by persons (including children) with reduced physical, sensory or mental capabilities, or lack of experience or knowledge, unless they have been given supervision or instruction concerning the use of the appliance by a person responsible for their safety. Children should be supervised to ensure that they do not play with the appliance.
2. In certain circumstances electrical appliances may be a danger hazard. Check the conformity of voltage and power settings, which are specified on the information plate attached to the appliance and/or packaging, with the usage conditions available.
3. Do not place heavy objects in or on these appliances, or use for storage, or let children play or swing from the door. Do not use the appliances until fully installed.
4. The electrical connection must be accessible after installation. The appliance must be electrically isolated before any maintenance can be performed. The appliance is not intended to be operated by means of an external timer or separate remote control system.

Safety information

5. If the supply cord is damaged, it must be replaced by the manufacturer or its service agent or a similarly qualified person in order to avoid a hazard.
6. The tumble dryer is not to be used if industrial chemicals have been used for cleaning.
7. **WARNING:** Clean the lint trap regularly.
8. Lint must not be allowed to accumulate around the dryer. Not applicable for appliances intended to be vented.
9. Adequate ventilation has to be provided to avoid the back flow of gases into the room from appliances burning other fuels, including open fires.
10. **CAUTION** - If this appliance is supplied from a cord extension set or an electrical portable device, the cord extension set or electrical portable device must be positioned so that it is not subjected to splashing or ingress of moisture.
11. Items that have been spotted or soaked with vegetable or cooking oil constitute a fire hazard and should not be placed in a tumble dryer. Oil-affected items can ignite spontaneously, especially when exposed to heat sources such as a tumble dryer. The items become warm, causing an oxidation reaction in the oil. Oxidation creates heat. If the heat cannot escape, the items can become hot enough to catch fire. Piling, stacking or storing oil-affected items can prevent heat from escaping and so create a fire hazard.
12. If it is unavoidable that fabrics that contain vegetable or cooking oil or have been contaminated by hair care products be placed in a tumble dryer they should first be washed in hot water with extra detergent – this will reduce, but not eliminate, the hazard. The “cool down” cycle of tumble dryers should not be used to reduce the temperature of the items. They should not be removed from the tumble dryer or piled or stacked while hot.
13. This appliance is for indoor use only.

Safety information

14. Items that have been previously cleaned in, washed in, soaked in or spotted with petrol/gasoline, Dry-cleaning solvents or other flammable or explosive substances should not be placed in a tumble dryer. Highly flammable substances commonly used in domestic environments include acetone, denatured alcohol, petrol/gasoline, kerosene, spot remover (some brands), turpentine, waxes and wax removers.
15. Item containing foam rubber (also known as latex foam) or similarly texture rubber-like materials should not be dried in a tumble dryer on a heat setting. Foam rubber materials can, when heated, produce fire by spontaneous combustion.
16. Fabric softeners or similar products should not be used in a tumble dryer to eliminate the effects of static electricity unless this practice is specifically recommended by the manufacturer of the fabric softener or product.
17. Undergarments that contain metal reinforcements should not be placed in a tumble dryer. Damage to the tumble dryer can result if metal reinforcements come loose during drying. When available a drying rack could be used for such items.
18. Plastic articles such as shower caps or babies' waterproof napkin covers should not be placed in a tumble dryer.
19. Rubber-backed articles, clothes fitted with foam rubber pads, pillows, galoshes and rubber-coated tennis shoes should not be placed in a tumble dryer.
20. Do not cover the air inlet or exhaust openings.
21. If appliances has ventilation openings in base, ensure carpet does not obstruct the openings.
22. The appliance must not be installed behind a lockable door, a sliding door or a door with a hinge on the opposite side to that of the tumble dryer in such a way that a full opening of the tumble dryer door is restricted.
23. The maximum mass of dry load is 7kg.
24. The final part of a tumble dryer cycle (cool down cycle) occurs without heat to ensure articles are left at temperatures that won't damage them.
25. **WARNING:** Never stop a dryer before the end of the drying cycle unless all items are quickly removed and spread out to allow heat dissipation.
26. Do not overturn the appliance either during operation or during maintenance.

Safety information

27. Always remove items from pockets (especially flammables like matches).

Correct Disposal of this product:



This marking indicates that this product should not be disposed with other household wastes throughout the EU. To prevent possible harm to the environment or human health from uncontrolled waste disposal, recycle it responsibly to promote the sustainable reuse of material resources. To return your used device, please use the return and collection systems or contact the retailer where the product was purchased. They may take this product for environmental safe recycling.

Safety information

Electric shock hazard

1. Do not pull the power cord to disconnect with the power source. Always grasp the plug to pull it out.
2. Do not use wet hands when disconnecting the power.
3. Do not damage the power cord and the power plug.

Injury danger

1. Do not disassemble and install the dryer under no instruction or supervision.
2. Do not stack this dryer on washing machine without stacking kits. (if want stacking on washing machine, please purchase the Independent parts and it must be installed by the manufacturer, its service agent or similarly qualified persons in order to avoid a hazard.)
3. Do not lean on the opened door of the dryer.
4. Do not place hot or burning items (for example candles) on this appliance.

Damage danger

1. Do not dry over the rated capacity.
2. Do not operate the dryer without the filter door and filter base.
3. Do not dry the clothes before being spun.
4. Do not expose the dryer directly under the sun, and indoor use only.
5. Do not install the dryer in the humid and drenching environment.
6. At the cleaning and maintenance, please do remember to pull out the power plug and do not directly wash the dryer with water.

Explosion danger

Please do not dry the clothes with some flammable substances such as coal oil, alcohol or there could be an explosion.

Transport

Move cautiously. Do not grasp any salient parts of machine. The appliance door must not be used as the handle for delivery. If the dryer can't be transported erect, the dryer can be slanted to right less than 30°.

Installation Position

1. It is recommended that, for your convenience, the machine is positioned close to your washing machine.
2. The tumble dryer must be installed in a clean place, where dirt does not build up. Air must be able to circulate freely all round the appliance. Do not obstruct the front air inlet or the air intake grilles at the back of the machine.
3. To keep vibration and noise to a minimum when the dryer is in use, it should be placed on a firm and level surface.
4. The feet must never be removed. Do not restrict the floor clearance through deep pile carpets, strips of wood or similar. This might cause heat built-up which would interfere with the operation of the appliance.

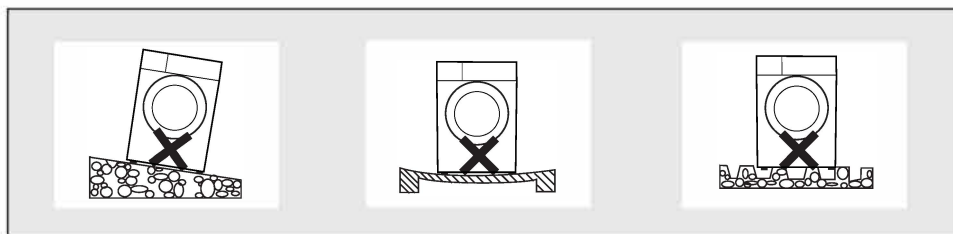

Level Adjusting

Once in its permanent operating position, check that the dryer is absolutely level with the aid of a spirit level. If it is not, adjust the feet with a tool.

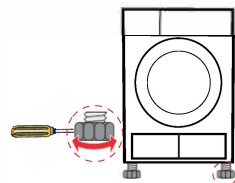

Power Supply Connection











1. Make sure that the voltage of the power supply is the same as the electric specification of the dryer.
2. Do not connect the dryer with the power connection board, the universal plug or socket.

Attention

- ❗ Leave to stand for 2 hours after transporting. Before first use, please use soft fabric to clean the inside drum.
 - a) Put some clean rags into the drum.
 - b) Plug in the power, press **【On/Off】**
 - c) Select the **【Refresh】** Programme, press **【Start/Pause】** button.
 - d) After finishing this programme, please follow the "cleaning and routine maintenance" (refer to page 15) to clean the filter door.
- ❗ During drying, the compressor and the water pump generate some noise.

Advice

1. Before drying, thoroughly spin the laundry in washing machine. High spin speed can reduce the drying time and save energy consumption.
2. For uniform drying result, sort the laundry according to fabric type and drying programme.
3. Before drying, please close zips, hooks and eyelets, button up, tie fabric belts, etc.
4. Do not over dry the clothes, because over dried clothes can easily get creases or shrinkage.
5. Do not dry the articles containing rubber or similar elastic materials such as raincoats, bicycle covers and etc.
6. Do not open the door before the program is finished - doing so may cause injury via heat.
7. Clean the lint filter and empty container after each use to avoid extension of drying time and energy consumption.
8. Please choose the related programme when drying wool material. This will ensure woolens are fresh and fluffy.
9. The Weight References as follows:

 Blended Coats (about 800g)	 Jackets (about 800g in cotton)	 Jeans Trousers (about 800g)	 Towel Quilts (about 900g in cotton)
 Single Sheets (about 600g in cotton)	 Work Clothes (upper and lower) (about 1120g in cotton)	 Pajamas (about 200g)	 Shirts (about 300g in cotton)
 Undershirts (about 180g in cotton)	 Underpants (about 70g in cotton)	 Socks (about 30g in blended material)	

Part description

Part Description

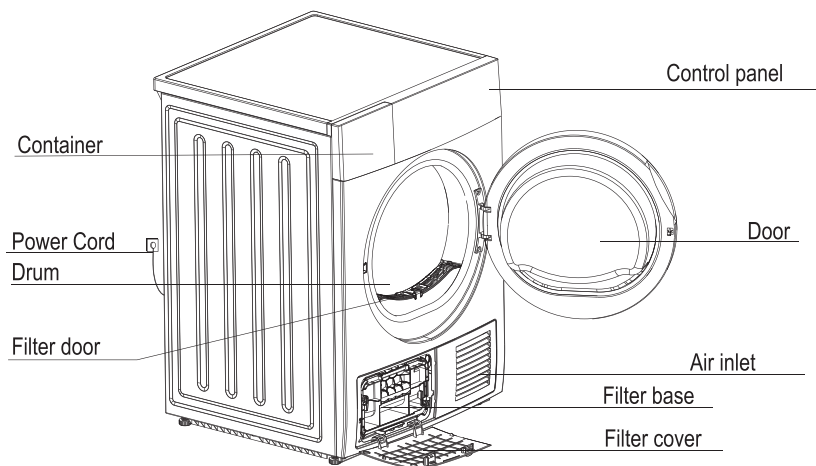

Accessories

The following parts are optional for specific models. If your dryer has following parts, please install them following the instruction below .

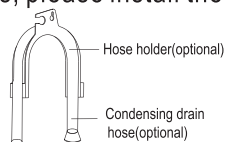

Installation step:

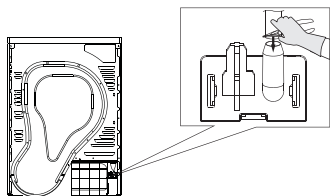

Step 1: removing the drain hose from the hose connector using plier.

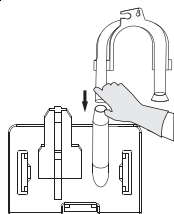

Step 2: insert the external drainage hose.

Part description

Step 3: put the hose holder on the washing basin or any other sink.

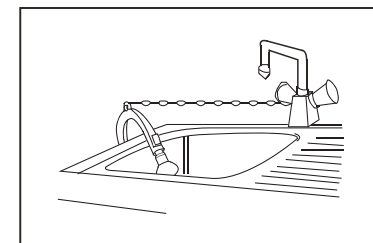
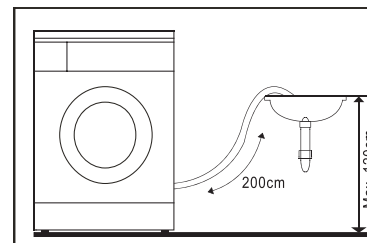

Quick start

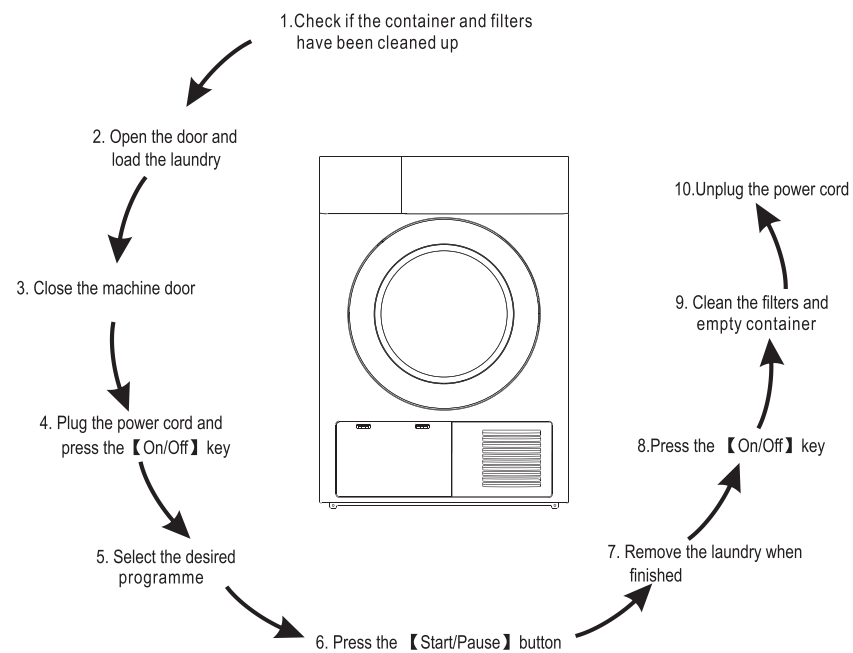

Description of controls

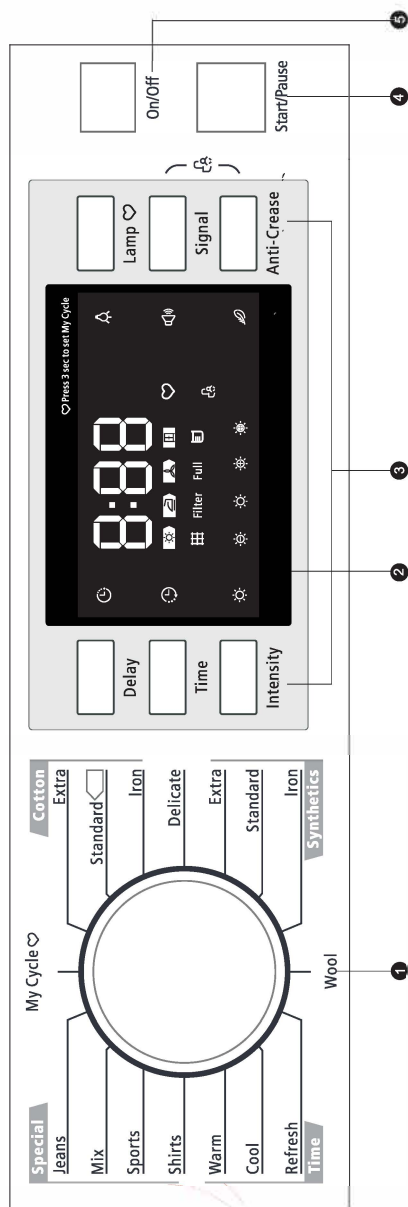

Description of controls

1. Programme Selection knob
2. Display
3. Specialty function buttons (Delay, Time, Intensity, Lamp, Signal, Anti-Crease, Childlock)
4. Start/Pause button
5. On/Off button

Display

	Delay start
	Time
	Child lock
	Remaining Time indicator/Error message
	Cycle phase status
	Clean filters (warning)
	Empty water container (warning)
	Dryness level (four grades)
	Drum lamp indicator
	Signal indicator
	Anti-crease mode

Selecting the programme

1. Press the **【On/Off】** key, when the LED display screen lights up, rotate the programme knob to select the desired programme.
2. Select the **【Delay】**, **【Time】**, **【Intensity】**, **【Signal】** or **【Anti-Crease】** functions for additional option.
3. Press the **【Start/Pause】** key.

Programme start

The drum will keep rotating after the program starts, the status light in the display area will flash in sequence, the remaining time displayed will change automatically.

Note:

Occasionally the drum may suspend for approximately 40 seconds during the drying process. This is normal. The dryer is automatically adjusting its time and will continue operation shortly.

Programme end

1. The drum will stop running after the programme ends, the display will show “0:00”, the last cycle phase status light will flash. The dryer will start **【Anti-crease】** function if user doesn't remove the load in time (refer to page 13). Please press **【On/Off】** key to cut off power and pull the plug out.
2. If there is an unexpected stoppage during the drying cycle and the machine displays an error code, please refer to page 17.

Programme	Weight (max)	Application/Properties	Delay	Time
Cotton	For cottons and coloureds made of cotton or linen.			
	Extra	To dry cotton pieces of clothing. Drying level: extra dry.	Y	N
	Standard	To dry cotton pieces of clothing. Drying level: cupboard dry.		
	Iron	To dry cotton pieces of clothing. Drying level: applicable to iron.	Y	N
Delicate	1.0kg	To dry delicate laundry that is suitable for drying or laundry which is advised to be hand-washed at a lower temperature.	Y	N
Synthetics	For non-iron washing made of synthetic and blended fabrics, cotton.			
	Extra	To dry thick or multi-layered synthetic fabrics. Drying level: extra dry.		
	Standard	To dry thin synthetic fabrics which are not ironed, such as easy care shirts, table linen, baby clothes, socks.	Y	N
	Iron	To dry thin synthetic fabrics which are also to be ironed, such as knitwear, shirts.		
Wool	1.0kg	For a fluffy and fresh wool clothing (Can not be used for drying wool clothing). When the cycle is done, take out the clothes at once, let them dry in the air.	Y	N
Special	Jeans	To dry jeans or leisure clothes that are spun at high speeds in the washing machine.		
	Mix	If you can not determine what the clothing's material is, please choose Mix.		
	Sports	To dry sportswear, thin fabrics, polyester, which are not ironed.	Y	N
	Shirts	For easy care clothes such as shirts and blouses with anti-crease mechanism for minimum ironing effort. Place clothes loosely in the dryer. Once dried, hang it on a clothes hanger.		
My Cycle		Define and save your favorite programme.		
Time	Warm	To warm clothes from minimum 10 min. to maximum 120 min. (in 10 min. steps).		
	Cool	To air clothes without blowing hot air from minimum 10 min. to maximum 30 min. (in 10 min. steps).	Y	Y
	Refresh	To refresh the clothes that have been kept at closed environments for a long time from minimum 20 min. to maximum 150 min. (in 10 min. steps).		

Note: 1. "Cotton+Extra" is for AS/NZS energy program.

2. The programmes above are only recommended for using, users can choose the appropriate programme according to the personal habits. Thick and multi-layered fabrics e.g. bedlinen, jeans, jackets etc. are not easy to dry, you'd better choose Jeans programme and maximum drying intensity level.

Specialty drying function

1. Instruction to the 【Delay】 drying procedure

To delay the drying programme from 0 hour to 24 hours. The delay time means the programme will start after x hours. When the delay programme starts, the time starts to decrease on the display and the ☺ icon blinks.

Steps in details

- (1). Load your laundry and make sure the machine door is closed.
- (2). Press the 【On/Off】 button, then to turn the programme selector knob and select a desired programme.
- (3). You can select the 【Anti-Crease】 or 【Signal】 functions according to your need.
- (4). To press the 【Delay】 key.
- (5). Continue to press the 【Delay】 to select the delay time.
- (6). After the 【Start/Pause】 key is pushed, the dryer is at the run condition. The drying procedure will be automatically performed when the delay time is over.
- (7). If you push the 【Start/Pause】 button again, the delay function will be paused.
- (8). If you want to cancel the “Delay” function, please press the 【On/Off】 button.

2. Instruction of the 【Time】 function

When the time programme is selected, the 【Time】 button can be used to adjust the drying time in 10 min. steps. The maximum time is 150 min.

3. Instruction of the 【Intensity】 function

Used to adjust the dryness level of the laundry. The level has four grades * * * * .

The drying time increases 3 minutes in every grade.

- (1). The intensity function can be activated only before the programme start.
- (2). Press the 【Intensity】 button repeatedly to select the drying time.
- (3). Except the 【Cotton Iron】 【Delicate】 【Synthetic Iron】 【Wool】 【Time】 , all other programmes can have the 【Intensity】 function applied.

4. Instruction of the 【My Cycle】 function

Used to define and save your favorite programmes that are used frequently.

- (1). Use the programme selector to select the required programme and other drying functions.
- (2). Press and hold the 【Intensity】 button for 3 seconds until the display flashes and the required programme has been saved.
- (3). Turn the programme selector to the 【My Cycle】 position, you can start your favorite programme. If you want to change the 【My Cycle】 settings, repeat the steps (1) and (2).

5. Instruction of the 【Lamp】

The lamp inside the drum will come on for 3 minutes when the button is pressed or 1 minute when the door is opened.

6. 【Signal】

Turning the buzzer on or off. The buzzer is automatically set to “on”. Press the 【signal】 key to change.

- (1) Dryer will sound if extra functions are selected.
- (2) If the dryer is running and the function knob is rotated the dryer will sound to remind the user this is not a valid operation.
- (3) When the dry cycle is complete the buzzer will sound.

7. Instruction of the 【Anti-Crease】 function

At the end of the drying cycle, the anti-crease operation time is 30 minutes (default) or 120 minutes (selected).

The 【Anti-Crease】 light shall illuminate when the anti-crease function is selected. This function prevents the laundry from creases. The laundry can be removed during the anti-crease phase. Except 【Cool】 , 【Refresh】 and 【Wool】 , all the other programmes have this function.

8. Instruction of the 【Child Lock】 feature

- (1). This machine incorporates a special child safety lock, which can prevent children from carelessly pressing keys.
- (2). When the dryer is in operation, press the 【anti-crease】 and 【signal】 buttons at the same time for 3 seconds to engage child lock. When child lock is set the display will show “🔒” icon and no other keys except 【on/off】 can be used. To remove child lock press the 【anti-crease】 and 【signal】 buttons at the same time for 3 seconds.

Empty the water container

1. Hold and pull out the water container with two hands;
2. Tilt the water container, pour out the condensed water into basin;
3. Install the water container.

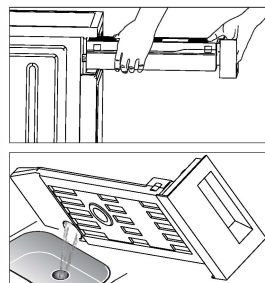

WARNING:

1. Empty the water container after each use, the programme will be paused and the “” icon will flash if the water container is full during the drying process. After the container is emptied, the dryer can be restarted by pressing **【Start/Pause】** button.
2. Do not drink the condensed water
3. Do not use the dryer without the water container.

Clean the filter door

1. Open the door.
2. Take out the filter door.
3. Clean the filter door, wipe off the scrap threads accumulated on the filter door.
4. Reinstall the filter door.

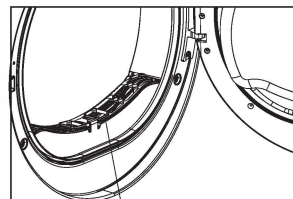

Clean filter base

1. Open the filter cover.
2. Unscrew both locking levers towards each other.
3. Clean the filter base completely.
4. Re-insert the filter base!
5. Screw both locking levers.
6. Close the filter cover flap until it locks into position.

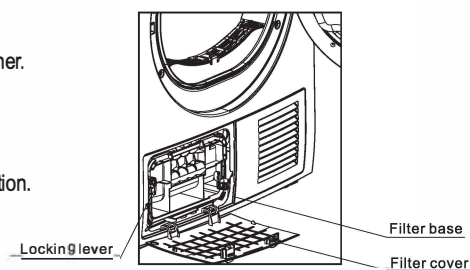

NOTE!

1. The fluff accumulated on the filter will block the air circulation, which will cause the extension of drying time and energy consumption;
2. Do disconnect the power cord before cleaning!
3. Do not operate the dryer without the filter!
4. Clean the filter after each use to prevent lint accumulation inside the dryer.

Clean heat exchanger

As necessary, approx. once every 2 months, remove the fluff from the heat exchanger using the sponge or soft brush.

When doing this, please use gloves.

Note: The fluff can be removed more easily if it is first dampened e. g. with a laundry dampener.

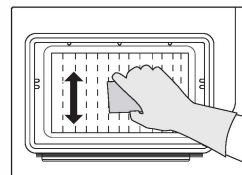

Malfunction display and solutions

Display	Reason	Solutions
“  ” is on	Container is full	Empty container
	Water pump failure or water level sensor failure	Please contact your local service center if the problem persists
“E32”	Humidity sensor failure	
“E33”	Temperature sensor failure	

Precautions

- ❗ Only authorised technicians can carry out repairs. Before you call customer service, please check if you can deal with the fault by yourself or if you have followed the user instructions. A technician will charge you for advice, even during the warranty period.

Problem	Solution
<ul style="list-style-type: none"> ● Display does not light up 	<ul style="list-style-type: none"> ● Check if the main plug is inserted. ● Check if the programme is selected. ● Check the main power supply.
<ul style="list-style-type: none"> ● Dryer does not start 	<ul style="list-style-type: none"> ● Check if the start button is pushed. ● Check if the door is entirely closed.
<ul style="list-style-type: none"> ● Door is open by itself 	<ul style="list-style-type: none"> ● Press door until it “clicks” into position. ● Check if the clothes is over load .
<ul style="list-style-type: none"> ● Degree of dryness is not reached or drying time too long 	<ul style="list-style-type: none"> ● Clean the filter door and filter base. ● Use the appropriate programme. ● keep the Air inlet clear.

- ❗ If you cannot deal with the fault by yourself and need help:
 1. Press the key **【On/Off】**.
 2. Pull out the mains plug and call the service department.

Specification

Power supply	220-240V~ 50Hz
Rated power	650W
Refrigerant	R134a
Ambient temperature	+5℃ ~+35℃
Overall Size	595×622×845(mm)
Rated Drying Capacity	7.0kg
Net Weight	51kg

Contains fluorinated greenhouse gases covered by the Kyoto Protocol.
Hermetically sealed

Note:

1. The rated capacity is the maximum capacity, make sure that the dry clothes which are loaded to the appliance do not exceed the rated capacity each time.
2. Do not install the tumble dryer in a room when there is a risk of frost occurring. At temperatures around freezing point the tumble dryer may not be able to operate properly.
3. There is a risk of damage if the condensed water is allowed to freeze in the pump, hoses and / or condensed water container.

Terms and Conditions

The following conditions apply in respect of the warranty given in this certificate:

1. Monaco Corporation Limited ("Monaco") warrants the following Robinhood products against manufacturing defects and faulty materials, under normal use and subject to the exclusions in this certificate, for a period of:
 - Rangehood, Ovens, Cooktops, Dishwashers, Refrigeration, Washing machines, Clothes Dryers** - 24 months from date of original purchase for domestic use.
 - Uniduct** - 12 months from date of original purchase for domestic use.
 - Ironing centre** - 12 months from date of original purchase for domestic use.
 - Sinks sets** - 5 years on stainless steel sink including draining bench from date of original purchase for domestic use, 6 months on all stainless steel accessories, including wire rack, colander and tray from date of original purchase for domestic use
 - Laundry Tub** - 5 years on stainless bowl, 24 months on Tap, Cabinet and other components from the date of original purchase for domestic use.
- "Original purchase", when used in this certificate, means purchase by the customer directly from Monaco or one of its approved suppliers.

2. This warranty is limited to the repair or replacement, at our option, within the warranty period of any component part which we at our discretion determine to contain faulty materials or a manufacturing defect in breach of this warranty. This warranty is subject to terms and conditions set out in this certificate.
3. The warranty only applies within New Zealand.
4. The customer must produce the original invoice or other purchase documentation as proof of the original purchase date.

Warranty exclusions

1. The warranty does not apply where, in Monaco's opinion:
 - The defect is caused by misuse, wear and tear, dirt, fire or accidental damage.
 - The product has been repaired or serviced by an unauthorised person.
 - The product was not installed in accordance with our instructions.
 - The product was purchased overseas or was not designed for use in New Zealand.
 - The product was not used, cleaned or cared for in accordance with our instructions.
 - The product was used outdoors.
2. In addition, this warranty does not extend to damage or defects which in our opinion, directly or indirectly arise from or are due to:
 - Exposing the product to acidic or corrosive materials or chemicals such as dyes, solvents, denture cleaner or acetone; Using inappropriate household cleaning products such as abrasive cream or powder cleansers, furniture polish, bleach mentholated spirits, drain cleaners, sugar soap, metal pads and strongly alkaline or acidic cleaners;
 - Heat damage, including from washing the product at high temperatures;
 - Impact or mishandling the product, including the impact caused by objects scraped along, thrown or dropped on the product; Failure to clean or maintain the product as recommended; or
 - product surface or excessive weight being placed on the product;
 - Structural or support changes in or affecting the building or the application where the product has been installed; any other causes specified in the product information as being excluded from this warranty.
3. Variations with the colour or gloss within the product or any ageing or fading of colour, shine or gloss level over time are not covered by this warranty. The warranty does not cover visual imperfections or blemishes in the surface and edges of the product that were not brought to your supplier's attention at the time you inspected the product.
4. Costs incurred on installation or removal of a product, or any reinstallation of a product, or any associated costs, are not covered by this warranty.
5. Monaco will not be liable for consequential or indirect loss or damage whatsoever and however arising out of or in connection with the supply, performance or removal of the product, including (but not limited to) loss of profit, loss of revenue, loss of contract, loss of goodwill or increased cost of workings, even if due to the negligence of Monaco or any of its approved suppliers, employees or agents.
6. Charcoal filters and light bulbs are not covered by this warranty
7. This warranty and the statements contained in this certificate or other documents given to you do not exclude, restrict or modify the application of any term implied into this warranty by statute, provided that (to the extent any statutory provision permits Monaco to limit its liability for a breach of an implied condition or warranty) Monaco's liability for such breach is limited to the payment of the cost of replacing the product, repairing the product or acquiring an equivalent product.
8. Subject to clause 5, our obligations under this warranty are limited to those set out in this certificate, and this warranty is expressly instead of all other warranties, express or implied, including any implied warranty of merchantability or fitness for a particular purpose and notwithstanding any course of dealing between the parties or custom and usage in trade to the contrary.

Terms and conditions are subject to change.

Terms and Conditions

If you are a consumer under the Australian Consumer Law, our goods come with guarantees that cannot be excluded under the Australian Consumer Law. You are entitled to a replacement or refund for a major failure and for compensation for any other reasonably foreseeable loss or damage. You are also entitled to have the goods repaired or replaced if the goods fail to be of acceptable quality and the failure does not amount to a major failure

1. Shiro Australia Pty Limited ("Shiro") also warrants the following Robinhood products against manufacturing defects and faulty materials, under normal use and subject to the exclusions in this certificate, for a period of:

- Rangehood, Ovens, Cooktops, Dishwashers, Refrigeration, Washing machines, Clothes Dryers** - 24 months from date of original purchase for domestic use.
- Uniduct** - 12 months from date of original purchase for domestic use.
- Ironing centre** - 12 months from date of original purchase for domestic use.
- Sinks sets** - 5 years on stainless steel sink including draining bench from date of original purchase for domestic use, 6 months on all stainless steel accessories, including wire rack, colander and tray from date of original purchase for domestic use.
- Laundry Tub** - 5 years on stainless bowl, 24 months on Tap, Cabinet and other components from the date of original purchase for domestic use. "Original purchase", when used in this certificate, means purchase by the customer directly from Shiro or one of its approved suppliers.

2. This warranty is limited to the repair or replacement, at our option, within the warranty period of any component part which we at our discretion determine to contain faulty materials or a manufacturing defect in breach of this warranty. This warranty is subject to terms and conditions set out in this certificate.
3. The warranty only applies within Australia.
4. For warranty service outside of capital city metropolitan area or 30 km from nearest authorised service agent you will be liable for reasonable travelling expenses and the cost of transport of the product or parts to and from the service agent
5. To make a claim under this warranty, you must produce the original invoice or other purchase documentation as proof of the original purchase date. You must send your claim to Shiro Australia Pty Limited, 104 Vanessa Street, Kingsgrove NSW 2208 within 7 days of any alleged defect or failure of the product first becoming apparent, you are responsible for the expense of making a claim under this warranty.

This warranty is given by:
 Shiro Australia Pty Ltd
 ABN 28 002 386 129
 Telephone: 1800 648 556
 Facsimile: 1800 628 577
 Email: customercare@shiro.com.au
 www.robinhood.com.au
 Attention Customer Services Manager

Warranty exclusions

1. The warranty does not apply where, in Shiro's opinion:
 - The defect is caused by misuse, wear and tear, dirt, fire or accidental damage.
 - The product has been repaired or serviced by an unauthorised person.
 - The product was not installed in accordance with our instructions.
 - The product was purchased overseas or was not designed for use in Australia.
 - The product was not used, cleaned or cared for in accordance with our instructions.
 - The product was used outdoors.
 2. All Robinhood Rangehoods are suitable for indoor use only and not suitable over BBQs or charcoal cookers designed for outdoor use.
 3. In addition, this warranty does not extend to damage or defects which in our opinion, directly or indirectly arise from or are due to: exposing the product to acidic or corrosive materials or chemicals such as dyes, solvents, denture cleaner or acetone; using inappropriate household cleaning products such as abrasive cream or powder cleansers, furniture polish, bleach, mentholated spirits, drain cleaners, sugar soap, metal pads and strongly alkaline or acidic cleaners; heat damage, including from washing the product at high temperatures; impact or mishandling the product, including the impact caused by objects scraped along, thrown or dropped on the product surface or excessive weight being placed on the product; structural or support changes in or affecting the building or the application where the product has been installed; failure to clean or maintain the product as recommended; or any other causes specified in the product information as being excluded from this warranty.
 4. Variations with the colour or gloss within the product or any ageing or fading of colour, shine or gloss level over time are not covered by this warranty. The warranty does not cover visual imperfections or blemishes in the surface and edges of the product that were not brought to your supplier's attention at the time you inspected the product.
 5. We will not be responsible under this warranty for, nor pay the costs of, removing the existing product, or reinstalling the new product, or any associated costs or damages.
 6. Charcoal filters and light bulbs are not covered by this warranty
- The benefits given by this warranty are in addition to other rights and remedies of consumers under any law in relation to the goods which cannot be excluded.

This warranty certificate is not intended to create a contract between Shiro Australia Pty Limited and the purchaser.

New Zealand

Monaco Corporation Ltd
 Telephone: (09) 415 6000
 Facsimile: (09) 415 7400
 Email: customercare@monacocorp.co.nz
 www.robinhood.co.nz

Australia

Shiro Australia Pty Ltd
 ABN 28 002 386 129
 Telephone: 1800 648 556
 Facsimile: 1800 628 577
 Email: customercare@shiro.com.au
 www.robinhood.com.au