

# How to Sew On Hooks & Eyes

Hooks & Eyes are the most basic of fasteners. They are designed to hold two finished edges together—use them on necklines or waistlines at the zipper closure. Since they are great for skirts, dresses, pants and accessories, it is a very handy skill to know how they are attached.

## What are the parts?

Straight-style Eye

Hook

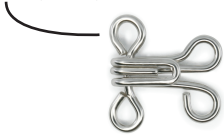

Angled view

Round-style Eye

Hook



1. Choose placement so hook & eye are not visible. Hold in place with straight pins. Then stitch as noted in following steps.

2. To hide knot, place your first stitch under the hook or in an area that doesn't show. Take two stitches across neck to secure.

Pass needle under hook and top layer of fabric pointed toward the wire loops. Needle should exit up through the loop.

## You will need:

- Your project
- Hooks & Eyes
- Hand sewing needle, any style – size 5–10
- Scissors
- Thread to match your project
- Straight pin to mark placement – any style pin

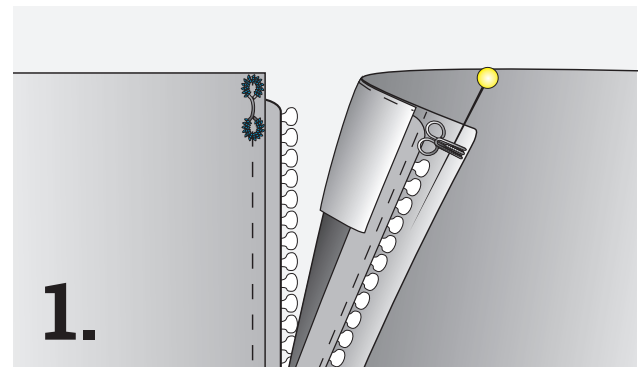

1.

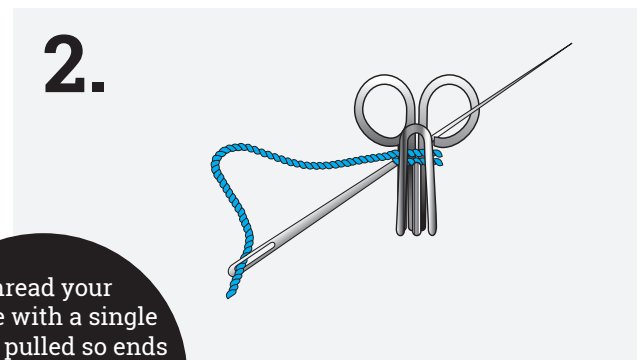

2.

Thread your needle with a single thread, pulled so ends are the same length. Knot ends together for a double sewing thread.



# TECHNIQUE TUTORIAL

3. Take small stitches over looped wire of hook. To secure stitching, always take 2-3 tiny stitches under or very close to the hook to prevent stitches from coming loose.

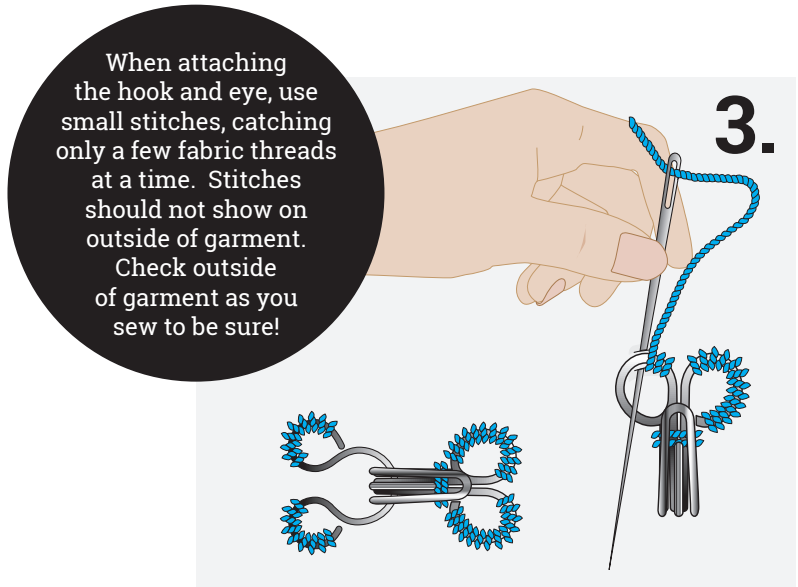

## Sewing on the eyes:

4. There are two styles of eyes included with most sets of hook and eyes – a straight-eye style and a round-eye style. Choose which is best for your garment.

The straight eye (4a) works best for lapped edges, such as at the neckline of a zippered dress. The round eye (4b) works for edges that meet or abut.

To attach either style, sew small stitches over the wire at loop holes as in diagrams to the right. When complete, be sure to take 2-3 stitches to secure as you did with the hook!

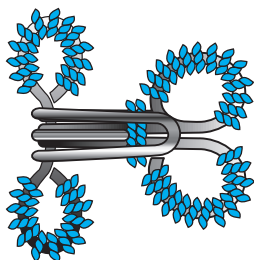
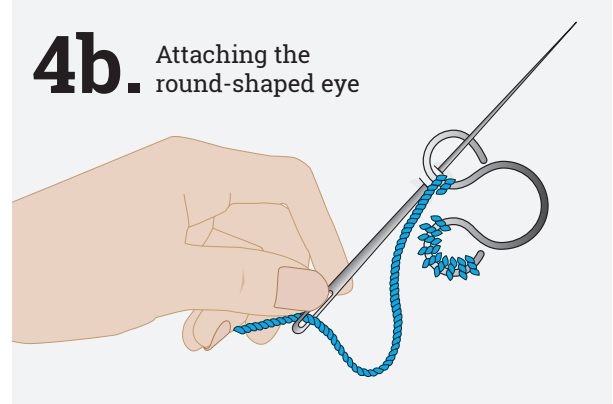

STRAIGHT EYE

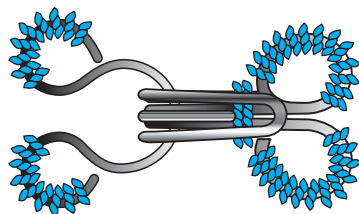

ROUND EYE

