

Dear Customer,

We thank you for giving us the opportunity to present our colour card.

This catalogue is new compared to the previous versions. In the new catalogue you can choose among a wide range of coloured tapes; we can obviously dye any other colour upon your request.

Our sales staff will be happy to help you with any further information you may require.

This catalogue includes both Riri and Meras range.

We would like to underline that, with the continued use of this Colour Card, the colour hues could change due to wear and tear. We therefore recommend avoiding excessive exposure to the light.

The tape used for the current colours is the one in use for Metal and Simmetrica 4 zips; the latter, if they are reproduced on tapes which are manufactured differently or on other yarns (e.g. Decor, Nylon or Satin, Knitwear, etc.) still maintain the same hue, but they could be seen as being different.

Riri, like its competitors, checks colours in a booth with D65 lighting. Looking at them with other sources of light, both natural and artificial, could affect the assessment of colours.

New and improved products are regularly added to the range as a result of technical developments and innovations as well as aesthetical influences from the fashion field.

Furthermore, Riri reserves the right to change the colours to comply with updates to the international standards.

With our best compliments.

Gentile Cliente,

La ringraziamo per averci offerto l'opportunità di illustrarle la nostra raccolta.

Questa selezione è nuova rispetto alle versioni precedenti, che sono pertanto superate e annullate.

Nella nuova raccolta potrà scegliere tra un'ampia gamma di colori.

Naturalmente possiamo tingere qualsiasi altro colore a sua richiesta. A tale proposito il nostro personale di vendita sarà lieto di illustrarle le modalità operative.

Come potrà notare, sono presenti i nastri sia dei prodotti Riri che Meras.

Ci permettiamo di sottolineare che, con l'utilizzo prolungato della presente selezione, la tonalità dei colori potrebbe cambiare a causa dell'usura. Consigliamo quindi di evitare un'eccessiva esposizione alla luce.

Il nastro utilizzato per i colori presenti è quello standard in uso per le cerniere Metal e Simmetrica 4; gli stessi, se riprodotti su nastri di costruzione o filati differenti (Decor, Nylon o Satin, Maglieria, ecc.), pur avendo lo stesso tono, possono essere percepiti diversamente da chi li osserva. Riri, come i suoi concorrenti, controlla i colori in cabina con luce D65. L'osservazione con altre fonti di luce, sia naturale che artificiale, può influire sulla valutazione.

In considerazione dei costanti miglioramenti dettati da una parte dagli sviluppi tecnologici e dalle innovazioni in generale, dall'altra dalle esigenze più strettamente estetiche e dalla moda, la informiamo che i prodotti Riri sono regolarmente sottoposti a miglioramenti e rinnovamenti.

Riri si riserva, inoltre, il diritto di apportare modifiche ai colori per adeguarsi agli aggiornamenti delle normative internazionali.

Con i nostri migliori complimenti e auguri per un proficuo lavoro.

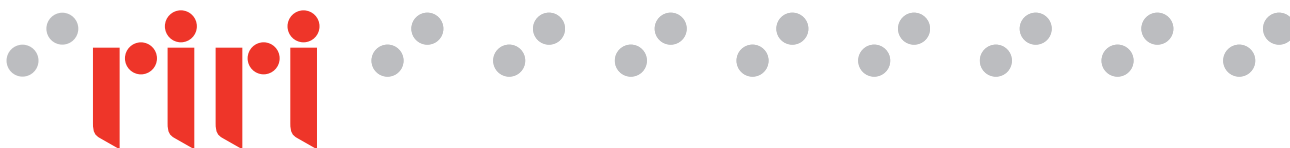

Excellence in details

Brand architecture · Architettura di brand

Masterbrand



Trademarks



Product lines
Linee di prodotto



- | | | |
|------------|---------|-------|
| Metal | Top | Nylon |
| Simmetrica | Star | |
| Filmetal | Topstar | |
| Eloxal | Solid | |
| Decor | Flex | |



Classic

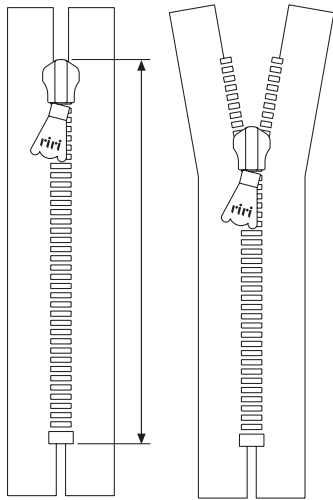

GE
Closed end - non separating
Chiuso non divisibile

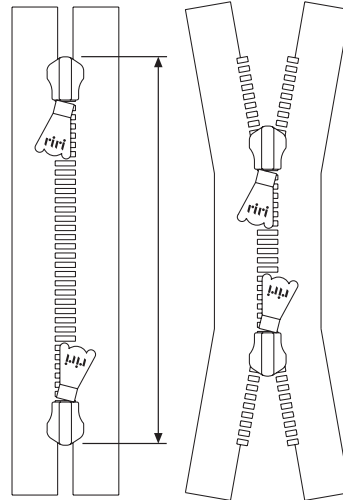

CD
Two-way closed end "X" type
Chiuso doppio cursore tipo "X"

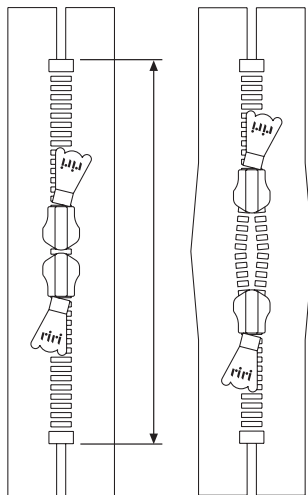

CK
Two-way closed end "O" type
Chiuso doppio cursore tipo "O"

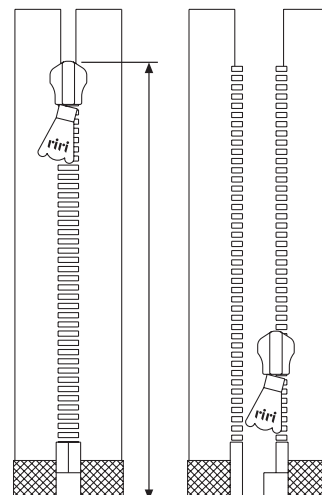

TB
Open end (Left hand puller, right insert)
Divisibile (Apertura a sinistra, inserimento a destra)

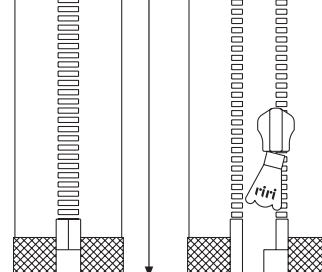

TBL
Open end (Right hand puller, left insert)
Divisibile (Apertura a destra, inserimento a sinistra)

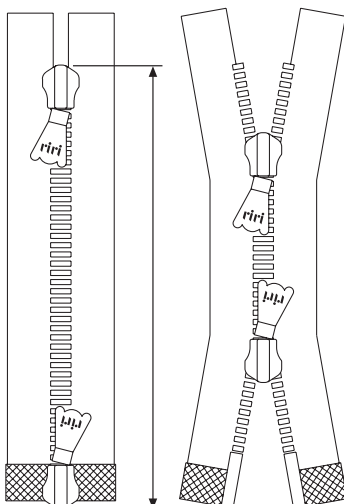

TBC
Two-way open end (Left hand puller, right insert)
Divisibile doppio cursore (Apertura a sinistra, inserimento a destra)

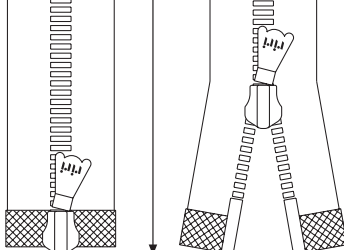

TBCL
Two-way open end (Right hand puller, left insert)
Divisibile doppio cursore (Apertura a destra, inserimento a sinistra)

**THE TOLERANCES
LE TOLLERANZE**

STANDARD

Length Lunghezza	≤ 50 cm	± 5 mm
Length Lunghezza	> 50 cm	± 1 %

REDUCED tolerances only under specific request.

Possibilità di tolleranze **RIDOTTE** solo su specifica richiesta.

Codice Colore	N. pagina
998	20 s.t.*
1001	20 s.t.*
2101	1
2102	1
2103	2
2104	2
2105	2
2106	2
2107	2
2108	2
2109	2
2110	2
2111	1
2112	2
2113	2
2114	2
2116	2
2117	1
2118	1
2119	1
2120	1
2121	1
2122	1
2123	1
2124	1
2125	2
2126	2
2127	2
2128	1
2129	1
2130	1
2131	1
2132	1
2133	1
2201	3
2202	3
2203	3
2204	3
2205	4
2206	3
2207	3
2208	4
2209	5
2211	4
2212	3
2213	3
2215	3
2216	3
2219	4

Codice Colore	N. pagina
2220	4
2221	3
2222	4
2223	4
2224	5
2225	5
2226	5
2227	3
2228	4
2229	3
2230	3
2231	3
2232	3
2233	4
2234	4
2235	4
2236	5
2237	5
2238	4
2239	4
2240	4
2241	4
2242	3
2243	4
2244	5
2245	5
2246	4
2301	6
2302	6
2303	6
2304	6
2305	6
2306	6
2307	6
2308	6
2309	6
2310	6
2311	6
2312	6
2313	7
2314	6
2315	6
2316	6
2318	6
2319	6
2403	7
2404	7
2405	7
2406	7

Codice Colore	N. pagina
2407	7
2409	7
2410	8
2411	8
2412	7
2414	8
2417	8
2418	7
2419	8
2420	8
2421	8
2422	8
2423	8
2424	8
2425	9
2429	8
2430	9
2432	7
2433	8
2434	7
2435	7
2436	7
2437	7
2438	7
2439	8
2440	8
2441	8
2442	8
2443	9
2444	9
2445	9
2446	9
2447	19 s.t.*
2449	8
2450	9
2451	7
2452	7
2501	10
2502	10
2503	10
2504	10
2505	10
2506	10
2507	10
2510	10
2511	10
2512	10
2513	10
2514	10

Codice Colore	N. pagina
2515	10
2516	10
2517	10
2518	11
2519	10
2520	10
2601	11
2603	12
2604	12
2605	12
2606	12
2607	12
2608	12
2609	12
2610	13
2613	11
2614	11
2615	11
2616	11
2618	12
2622	11
2623	12
2625	13
2626	13
2627	13
2628	11
2629	11
2630	12
2633	11
2634	12
2635	11
2636	12
2637	11
2638	11
2639	11
2640	12
2641	12
2642	12
2643	12
2644	13
2645	13
2646	13
2647	13
2648	16
2649	11
2650	11
2651	11
2652	12
2653	13

Codice Colore	N. pagina
2701	15
2702	15
2703	15
2704	16
2705	15
2706	15
2707	14
2708	14
2709	14
2710	14
2711	15
2712	15
2714	14
2715	14
2720	15
2721	15
2722	14
2723	15
2733	15
2734	15
2735	15
2736	15
2737	16
2738	16
2739	14
2740	14
2741	14
2742	14
2743	14
2744	14
2745	15
2746	14
2747	16
2748	16
2749	14
2750	14
2751	14
2752	15
2753	15
2801	17
2802	17
2803	17
2804	17
2805	17
2806	17
2807	17
2808	17
2809	17
2810	17

Codice Colore	N. pagina
2811	17
2812	17
2813	18
2814	18
2815	18
2816	18
2817	18
2818	18
2819	17
2820	17
2821	18
2822	18
2823	18
2824	18
2825	17
2826	18
2827	18
2828	18
2829	18
2830	18
2831	18
2832	17
2833	17
3110	21 s.t.*
3118	19 s.t.*
3119	19 s.t.*
3120	19 s.t.*
3121	19 s.t.*
3124	19 s.t.*
3125	21 s.t.*
3128	19 s.t.*
3131	19 s.t.*
3132	19 s.t.*
3134	19 s.t.*
3138	19 s.t.*
3143	20 s.t.*
3200	19 s.t.*
3214	21 s.t.*
3224	21 s.t.*
3225	19 s.t.*
3265	19 s.t.*
3280	19 s.t.*
3419	21 s.t.*
3627	21 s.t.*
3628	19 s.t.*
3651	19 s.t.*
3736	21 s.t.*
3826	21 s.t.*
3999	21 s.t.*

Codice Colore	N. pagina
8002	19 s.t.*

***= sezione NASTRI SPECIALE (special tapes)**

	Classic 4 - 5 - 8	Invisible
2128	M	M
2124		
2131		
2123		
2122	M	M
2121	M	M
2119	M	M
2130		
2120		
2129	M	M
2102	M	
2118	M	M
2117	M	M
2133	M	
2111	M	M
2132	M	
2101	M	M

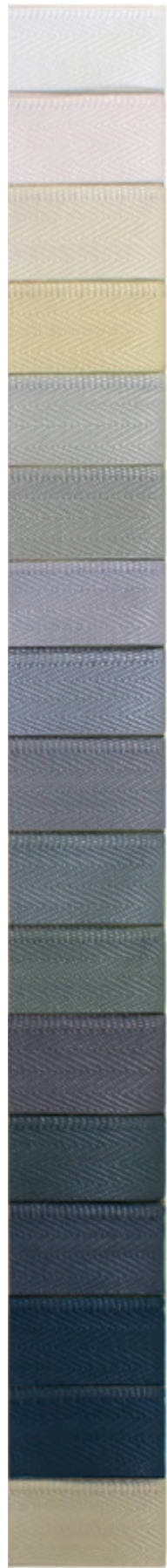





















Mopus



	2128	2124	2131	2123	2122	2121	2119	2130	2120	2129	2102	2118	2117	2133	2111	2132	2101	
	☑	☑	☑	☑	☑	☑	☑	☑	☑	☑	☑	☑	☑	☑	☑	☑	☑	Metal 4-6-8 • Simm. 4-6-8
	☑	☑	☑	☑	☑	☑	☑	☑	☑	☑	☑	☑	☑	☑	☑	☑	☑	Metal 10-14
	☑	☑	☑	☑	☑	☑	☑	☑	☑	☑	☑	☑	☑	☑	☑	☑	☑	Eloxal 6-8
	☑	☑	☑	☑	☑	☑	☑	☑	☑	☑	☑	☑	☑	☑	☑	☑	☑	Topstar
	☑	☑	☑	☑	☑	☑	☑	☑	☑	☑	☑	☑	☑	☑	☑	☑	☑	Top 6E-8E-10E
	☑	☑	☑	☑	☑	☑	☑	☑	☑	☑	☑	☑	☑	☑	☑	☑	☑	Star
	☑	☑	☑	☑	☑	☑	☑	☑	☑	☑	☑	☑	☑	☑	☑	☑	☑	Solid 6-8-10
	☑	☑	☑	☑	☑	☑	☑	☑	☑	☑	☑	☑	☑	☑	☑	☑	☑	Decor 4-4E-6-6E-8-8E-10E
	☑	☑	☑	☑	☑	☑	☑	☑	☑	☑	☑	☑	☑	☑	☑	☑	☑	Decor 14
	☑	☑	☑	☑	☑	☑	☑	☑	☑	☑	☑	☑	☑	☑	☑	☑	☑	Flex 1
	☑	☑	☑	☑	☑	☑	☑	☑	☑	☑	☑	☑	☑	☑	☑	☑	☑	Nylon 3-4-6
	☑	☑	☑	☑	☑	☑	☑	☑	☑	☑	☑	☑	☑	☑	☑	☑	☑	Nylon 10

2019

	Classic 4 - 5 - 8	Invisible
2116		
2110		
2127		
2126		
2109		
2108		
2107		
2106		
2125		
2105		
2104		
2103		
2114		
2113		
2112		





2116	2110	2127	2126	2109	2108	2107	2106	2125	2105	2104	2103	2114	2113	2112	
☐	☐	☐	☐	☐	☐	☐	☐	☐	☐	☐	☐	☐	☐	☐	Metal 4-6-8 • Simm. 4-6-8
☐	☐	☐	☐	☐	☐	☐	☐	☐	☐	☐	☐	☐	☐	☐	Metal 10-14
☐	☐	☐	☐	☐	☐	☐	☐	☐	☐	☐	☐	☐	☐	☐	Eloxal 6-8
☐	☐	☐	☐	☐	☐	☐	☐	☐	☐	☐	☐	☐	☐	☐	Topstar
☐	☐	☐	☐	☐	☐	☐	☐	☐	☐	☐	☐	☐	☐	☐	Top 6E-8E-10E
☐	☐	☐	☐	☐	☐	☐	☐	☐	☐	☐	☐	☐	☐	☐	Star
☐	☐	☐	☐	☐	☐	☐	☐	☐	☐	☐	☐	☐	☐	☐	Solid 6-8-10
☐	☐	☐	☐	☐	☐	☐	☐	☐	☐	☐	☐	☐	☐	☐	Decor 4-4E-6-6E-8-8E-10E
☐	☐	☐	☐	☐	☐	☐	☐	☐	☐	☐	☐	☐	☐	☐	Decor 14
☐	☐	☐	☐	☐	☐	☐	☐	☐	☐	☐	☐	☐	☐	☐	Flex 1
☐	☐	☐	☐	☐	☐	☐	☐	☐	☐	☐	☐	☐	☐	☐	Nylon 3-4-6
☐	☐	☐	☐	☐	☐	☐	☐	☐	☐	☐	☐	☐	☐	☐	Nylon 10

Classic 4 - 5 - 8
Invisible

2229	2207	2242	2206	2221	2231	2216	2213	2215	2212	2230	2203	2204	2227	2201	2202
------	------	------	------	------	------	------	------	------	------	------	------	------	------	------	------





2229	2207	2242	2206	2221	2231	2232	2216	2213	2215	2212	2230	2203	2204	2227	2201	2202	Metal 4-6-8 • Simm. 4-6-8
																	Metal 10-14
																	Eloxal 6-8
																	Topstar
																	Top 6E-8E-10E
																	Star
																	Solid 6-8-10
																	Decor 4-4E-6-6E-8-8E-10E
																	Decor 14
																	Flex 1
																	Nylon 3-4-6
																	Nylon 10

Classic 4 - 5 - 8
Invisible









2243	2208	2239	2246	2219	2234	2223	2222	2241	2220	2228	2205	2240	2211	2238	2235
------	------	------	------	------	------	------	------	------	------	------	------	------	------	------	------





2243	2208	2239	2246	2219	2234	2223	2233	2222	2241	2220	2228	2205	2240	2211	2238	2235	Metal 4-6-8 • Simm. 4-6-8
✓	✓	✓	✓	✓	✓	✓	✓	✓	✓	✓	✓	✓	✓	✓	✓	✓	Metal 10-14
✓	✓	✓	✓	✓	✓	✓	✓	✓	✓	✓	✓	✓	✓	✓	✓	✓	Eloxal 6-8
✓	✓	✓	✓	✓	✓	✓	✓	✓	✓	✓	✓	✓	✓	✓	✓	✓	Topstar
✓	✓	✓	✓	✓	✓	✓	✓	✓	✓	✓	✓	✓	✓	✓	✓	✓	Top 6E-8E-10E
																	Star
																	Solid 6-8-10
✓	✓	✓	✓	✓	✓	✓	✓	✓	✓	✓	✓	✓	✓	✓	✓	✓	Decor 4-4E-6-6E-8-8E-10E
																	Decor 14
																	Flex 1
✓	✓	✓	✓	✓	✓	✓	✓	✓	✓	✓	✓	✓	✓	✓	✓	✓	Nylon 3-4-6
✓	✓	✓	✓	✓	✓	✓	✓	✓	✓	✓	✓	✓	✓	✓	✓	✓	Nylon 10

2019

	Classic 4 - 5 - 8	Invisible
2226		
2225		
2224		
2237		
2236		
2209		
2245		
2244		



Mopus



2226	2225	2224	2237	2236	2209	2245	2244	Metal 4-6-8 • Simm. 4-6-8
☐	☐	☐	☐	☐	☐	☐	☐	Metal 10-14
☐	☐	☐	☐	☐	☐	☐	☐	Eloxal 6-8
☐	☐	☐	☐	☐	☐	☐	☐	Topstar
☐	☐	☐	☐	☐	☐	☐	☐	Top 6E-8E-10E
☐	☐	☐	☐	☐	☐	☐	☐	Star
☐	☐	☐	☐	☐	☐	☐	☐	Solid 6-8-10
☐	☐	☐	☐	☐	☐	☐	☐	Decor 4-4E-6-6E-8-8E-10E
☐	☐	☐	☐	☐	☐	☐	☐	Decor 14
☐	☐	☐	☐	☐	☐	☐	☐	Flex 1
☐	☐	☐	☐	☐	☐	☐	☐	Nylon 3-4-6
☐	☐	☐	☐	☐	☐	☐	☐	Nylon 10

2019

Classic 4 - 5 - 8
Invisible

2315 2307 2319 2306 2311 2305 2318 2312 2309 2304 2316 2303 2310 2302 2308 2301 2314



Mopus



2315	2307	2319	2306	2311	2305	2318	2312	2309	2304	2316	2303	2310	2302	2308	2301	2314	Metal 4-6-8 • Simm. 4-6-8	
																		Metal 10-14
																		Eloxal 6-8
																		Topstar
																		Top 6E-8E-10E
																		Star
																		Solid 6-8-10
																		Decor 4-4E-6-6E-8-8E-10E
																		Decor 14
																		Flex 1
																		Nylon 3-4-6
																		Nylon 10



2438	2432	2437	2409	2407	2406	2405	2452	2412	2436	2404	2403	2435	2451	2434	2418	2313	Metal 4-6-8 • Simm. 4-6-8	
☑	☑	☑	☑	☑	☑	☑	☑	☑	☑	☑	☑	☑	☑	☑	☑	☑	☑	Metal 10-14
☑	☑	☑	☑	☑	☑	☑	☑	☑	☑	☑	☑	☑	☑	☑	☑	☑	☑	Eloxal 6-8
☑	☑	☑	☑	☑	☑	☑	☑	☑	☑	☑	☑	☑	☑	☑	☑	☑	☑	Topstar
☑	☑	☑	☑	☑	☑	☑	☑	☑	☑	☑	☑	☑	☑	☑	☑	☑	☑	Top 6E-8E-10E
☑	☑	☑	☑	☑	☑	☑	☑	☑	☑	☑	☑	☑	☑	☑	☑	☑	☑	Star
☑	☑	☑	☑	☑	☑	☑	☑	☑	☑	☑	☑	☑	☑	☑	☑	☑	☑	Solid 6-8-10
☑	☑	☑	☑	☑	☑	☑	☑	☑	☑	☑	☑	☑	☑	☑	☑	☑	☑	Decor 4-4E-6-6E-8-8E-10E
☑	☑	☑	☑	☑	☑	☑	☑	☑	☑	☑	☑	☑	☑	☑	☑	☑	☑	Decor 14
☑	☑	☑	☑	☑	☑	☑	☑	☑	☑	☑	☑	☑	☑	☑	☑	☑	☑	Flex 1
☑	☑	☑	☑	☑	☑	☑	☑	☑	☑	☑	☑	☑	☑	☑	☑	☑	☑	Nylon 3-4-6
☑	☑	☑	☑	☑	☑	☑	☑	☑	☑	☑	☑	☑	☑	☑	☑	☑	☑	Nylon 10

Classic 4 - 5 - 8	
	Invisible
2429	2429
2442	2442
2449	2449
2424	2424
2423	2423
2420	2420
2419	2419
2422	2422
2441	2441
2440	2440
2439	2439
2417	2417
2421	2421
2411	2411
2433	2433
2414	2414
2410	2410







Mopus



2429	2442	2449	2424	2423	2420	2419	2422	2441	2440	2439	2417	2421	2411	2433	2414	2410	Metal 4-6-8 • Simm. 4-6-8
✓	✓	✓	✓	✓	✓	✓	✓	✓	✓	✓	✓	✓	✓	✓	✓	✓	✓
✓	✓	✓	✓	✓	✓	✓	✓	✓	✓	✓	✓	✓	✓	✓	✓	✓	Metal 10-14
✓	✓	✓	✓	✓	✓	✓	✓	✓	✓	✓	✓	✓	✓	✓	✓	✓	Eloxal 6-8
✓	✓	✓	✓	✓	✓	✓	✓	✓	✓	✓	✓	✓	✓	✓	✓	✓	Topstar
✓	✓	✓	✓	✓	✓	✓	✓	✓	✓	✓	✓	✓	✓	✓	✓	✓	Top 6E-8E-10E
✓	✓	✓	✓	✓	✓	✓	✓	✓	✓	✓	✓	✓	✓	✓	✓	✓	Star
✓	✓	✓	✓	✓	✓	✓	✓	✓	✓	✓	✓	✓	✓	✓	✓	✓	Solid 6-8-10
✓	✓	✓	✓	✓	✓	✓	✓	✓	✓	✓	✓	✓	✓	✓	✓	✓	Decor 4-4E-6-6E-8-8E-10E
✓	✓	✓	✓	✓	✓	✓	✓	✓	✓	✓	✓	✓	✓	✓	✓	✓	Decor 14
✓	✓	✓	✓	✓	✓	✓	✓	✓	✓	✓	✓	✓	✓	✓	✓	✓	Flex 1
✓	✓	✓	✓	✓	✓	✓	✓	✓	✓	✓	✓	✓	✓	✓	✓	✓	Nylon 3-4-6
✓	✓	✓	✓	✓	✓	✓	✓	✓	✓	✓	✓	✓	✓	✓	✓	✓	Nylon 10

2019

	Classic 4 - 5 - 8	Invisible
		
		
		
		
		

2444 2445 2446 2425 2443 2450 2430



Mopus



2444 2445 2446 2425 2443 2450 2430

2444	2445	2446	2425	2443	2450	2430	Metal 4-6-8 • Simm. 4-6-8
☐	☐	☐	☐	☐	☐	☐	Metal 10-14
☐	☐	☐	☐	☐	☐	☐	Eloxal 6-8
☐	☐	☐	☐	☐	☐	☐	Topstar
							Top 6E-8E-10E
							Star
							Solid 6-8-10
							Decor 4-4E-6-6E-8-8E-10E
							Decor 14
							Flex 1
							Nylon 3-4-6
							Nylon 10

2019

Mopua

2639	2649	2622	2614	2638	2635	2637	2650	2629	2601	2628	2633	2613	2518
M		M		M	M	M	M			M	M		M
M		M		M	M	M	M			M	M		M

Classic 4 - 5 - 8
Invisible

2736	2720	2703	2705	2735	2702	2701	2712	2752	2706	2753	2711	2733	2723	2734	2721	2745
			M				M		M	M		M	M	M		M
			M				M		M			M	M			M

Classic 4 - 5 - 8
Invisible

Mepura



2747 2738 2648 2737 2704 2748

Classic 4 - 5 - 8
Invisibile

M M
M M

2019

Mapeva



2801 2804 2806 2803 2807 2802 2808 2825 2809 2810 2819 2811 2812 2805 2832 2833 2820

Classic 4 - 5 - 8

Invisibile

M M

M M

M

M M

M

M

2019



SPECIAL TAPES

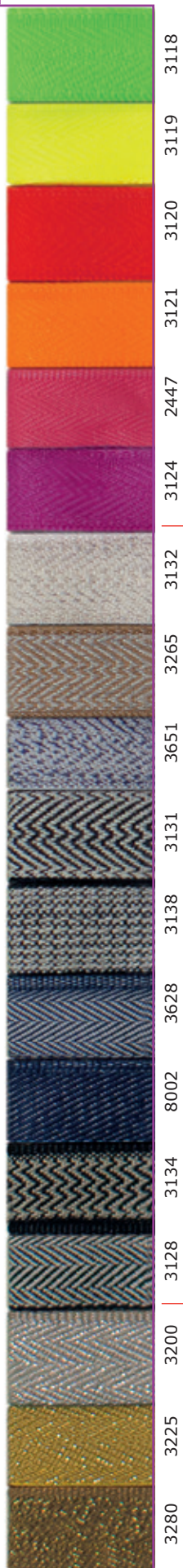

fluo

Tape treated with fluorescent dyestuff which releases a particular luminosity at ultraviolet light.

Nastro trattato con coloranti fluorescenti che emettono una luminosità particolare ai raggi ultravioletti.

mélange

Tape made of polyester or mixed cotton yarn. A yarn with one color for the weft and another for the warp is woven to produce a "melange" effect.

Nastro con filato in poliestere o misto cotone. Viene intrecciato un filato di trama di un colore con un colore differente in ordito per creare appunto un effetto "mescolato".

lurex

Weave of polyester and viscose threads covered by a metallic thin layer to obtain a lamé effect.

Intreccio di filati di poliestere e di viscosa ricoperti di lamine metalliche per ottenere l'effetto lamé.

carbon

cotton

raw

Manufactured tape with raw polyester threads. Not recommended for garment dye due to high temperatures, which could damage the synthetic or metallic parts of the zipper.

Nastro eseguito con filati grezzi di poliestere. Non consigliato per la tintura in capo a causa delle alte temperature del processo tintoriale che potrebbero danneggiare le parti metalliche o sintetiche della cerniera.

Cotton tape, suitable for garment dye products. Dyeing tests on samples are necessary before starting production.

Nastro in cotone, ideale per le tinture in capo. È indispensabile eseguire prove di tintura con campioni di cerniere prima di procedere alla produzione dei capi tinti.

Tape which allows, thanks to longitudinal carbon threads, the release of electrostatic energy once earthed. The threads are made of mixed carbon fibres and polyester.

Nastro che permette, grazie ai fili di carbonio longitudinali, lo scarico di corrente elettrostatica una volta collegato a una terra. I filati sono misti carbonio e poliestere.

	Metal 4 - Simmetrica 4	r
	Metal 6 - Simm. 6 - Eloxal 6	r
	Metal 8 - Simm. 8 - Eloxal 8	r
	Topstar	r
	Top 6E - Top 8E - Top 10E	r
	Star	r
	Solid 6 - Solid 8 - Solid 10	r
	Decor 4E - Decor 6E	r
	Decor 8E	r
	Decor 10E	r
		998
		1001
		3143



998



raw

Manufactured tape with raw polyester threads. Not recommended for garment dye due to high temperatures, which could damage the synthetic or metallic parts of the zipper.

Nastro eseguito con filati grezzi di poliestere. Non consigliato per la tintura in capo a causa delle alte temperature del processo tintoriale che potrebbero danneggiare le parti metalliche o sintetiche della cerniera.

1001



cotton

Cotton tape, suitable for garment dye products. Dyeing tests on samples are necessary before starting production.

Nastro in cotone, ideale per le tinture in capo. È indispensabile eseguire prove di tintura con campioni di cerniere prima di procedere alla produzione dei capi tinti.

3143



carbon

Tape which allows, thanks to longitudinal carbon threads, the release of electrostatic energy once earthed. The threads are made of mixed carbon fibres and polyester.

Nastro che permette, grazie ai fili di carbonio longitudinali, lo scarico di corrente elettrostatica una volta collegato a una terra. I filati sono misti carbonio e poliestere.

Aramidic yarn

Special non-flammable aramidic fiber yarn (i.e. it can be charred but does not burn). Able to withstand temperatures up to nearly 400°C. For this reason it is used in the military sector and for fire-resistant overalls.

Particolare filato di fibra aramidica che ha la caratteristica di essere anti fiamma (si carbonizza, ma non brucia). In grado di resistere a temperature vicine ai 400°C. Proprio per questo motivo viene utilizzato in campo militare e per tute ignifughe.

Metal 6 - Solid 6 - Top 6

Metal 8 - Solid 8/10 - Top 8

3826 3110 3627 3125 3736 3224 3214 3419 3999

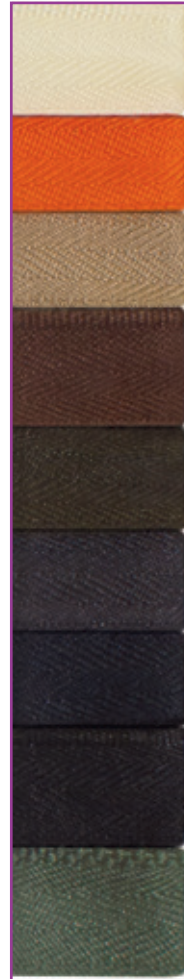

3826	3110	3627	3125	3736	3224	3214	3419	3999
------	------	------	------	------	------	------	------	------

								
---	---	---	--	--	--	--	--	--

Aramidic yarn

Special non-flammable aramidic fiber yarn (i.e. it can be charred but does not burn). Able to withstand temperatures up to nearly 400°C. For this reason it is used in the military sector and for fire-resistant overalls.

Particolare filato di fibra aramidica che ha la caratteristica di essere anti fiamma (si carbonizza, ma non brucia). In grado di resistere a temperature vicine ai 400°C. Proprio per questo motivo viene utilizzato in campo militare e per tute ignifughe.

knitwear gros grain

Tape with polyester yarn made with special weaving which makes it look "rugged" and slightly more rigid.
 Suitable to reproduce vertical lines because the special weft and warp weaving allows for clearly defined vertical lines.
 Here an example.

Nastro con filato in poliestere realizzato con un particolare intreccio che conferisce un aspetto "ruvido" e leggermente piu' rigido.
 Adatto per riprodurre righe verticali in quanto il particolare intreccio trama e ordito consente una buona definizione delle linee verticali.
 Qui accanto un esempio.

Polyester yarn tape whose manufacturing is designed to facilitate the application with fabric using knitwear machinery.
 In this ribbon the central part of the tape has threads which are a bit thinner; this is an ideal condition for inserting large knitwear needles. This manufacturing method does not jeopardise its resistance.

Nastro in filato di poliestere con una costruzione studiata appositamente per facilitare l'applicazione con tessuto a maglia con macchine di maglieria. Il nastro ha la parte centrale della fettuccia con fili più radi, condizione ideale per facilitare l'inserimento di grossi aghi di maglieria. Tale costruzione non pregiudica la sua resistenza.

knitwear

Tape made of polyester yarn, especially thin and shiny; it produces a "satin" look and feel.

Nastro con filato in poliestere particolarmente sottile e lucido; conferisce un aspetto e una mano effetto "seta".

satin

Tape produced using nylon. Its name comes from the Latin "vellus": fleece, or coat, and is well suited to describe its typical finish. Soft and pleasant feel and appearance.

Nastro con filato in nylon con effetto velluto. Il nome è derivato dal termine latino "vellus": vello, tosone o mantello, e ben si presta a descriverne la tipica finitura. Morbido al tatto e piacevole alla vista.

velvet

Tape with polyester yarn, produced on special looms; this processing makes it possible to create new patterns, reproduce logos or writings.
 Here an example.

Nastro con filato in poliestere, prodotto con particolari telai; tale lavorazione consente di creare nuovi pattern, riprodurre loghi o scritte.
 Qui accanto un esempio.

jacquard

Metal 4 - Simmetrica 4
 Metal 6 - Simm. 6
 Metal 8 - Simm. 8
 Decor 4E - Decor 6E
 Nylon 4 - 6
 Nylon 10

r r r r r

r r

r r r r r

r r

r r r





**COIL COLOR CARD
FOR NYLON 4, 6, 10**

Dear Customer,

We are pleased to present to you the colour card for the shade choice for zip chain and stitching, for zippers belonging to the NYLON family (4, 6, 10), particularly the METALLIC (Fig. 2). In the Fig. 1 you can see an example of NYLON MIX.

Several color combinations are available for the NYLON MIX: for tapes, all the colors enabled on this Color Card; for coils and sewing yarns, you can find the list of colors in the table on page NYLON MIX.

There are 8 combinations of standard chain and sewing thread available for the category METALLIC.

We are at your disposal to discuss any requests for combinations outside the defined standard. Our sales staff will be glad to help you with any enquiries.

We would like to emphasize that due to prolonged use of this selection the shade of the colours may deteriorate. To minimize any such discoloration, avoid prolonged exposure to light sources of these products.

With our best compliments.

Gentile Cliente,

Abbiamo il piacere di presentarle la carta colori valida nella scelta della tonalità della catena e del cucirino, per le cerniere appartenenti alla famiglia NYLON (4, 6, 10), in particolare la METALLIZZATA (Fig. 2). Nella Fig. 1 trovate un'immagine che raffigura la NYLON MIX.

La NYLON MIX permette molteplici combinazioni: per i nastri, i colori sono quelli abilitati nella presente Carta Colori; per le spirali e i cucirini, i colori disponibili sono riportati all'interno della tabella che trovate nella pagina NYLON MIX.

Ci sono 8 combinazioni standard di catena e cucirino disponibili per la categoria METALLIZZATA.

Siamo comunque a disposizione per valutare eventuali richieste di combinazioni al di fuori dello standard definito. Il nostro personale di vendita sarà lieto di illustrarle le modalità operative.

Ci permettiamo di sottolineare che a causa dell'utilizzo prolungato della presente selezione la tonalità dei colori potrebbe deteriorarsi. Per minimizzare tale eventuale sbiadimento, eviti l'esposizione prolungata di queste pagine alle sorgenti luminose.

Con i nostri migliori complimenti e auguri per un proficuo lavoro.

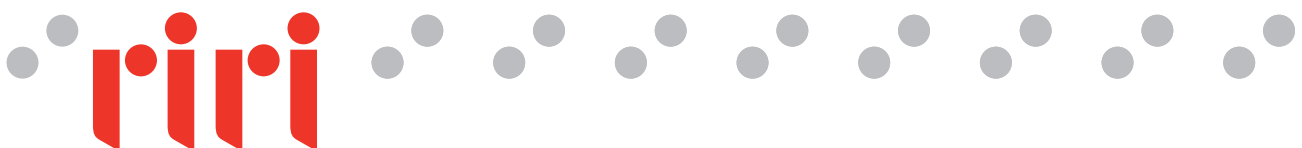

Excellence in details

How a nylon zipper is made - Come è fatta una cerniera nylon

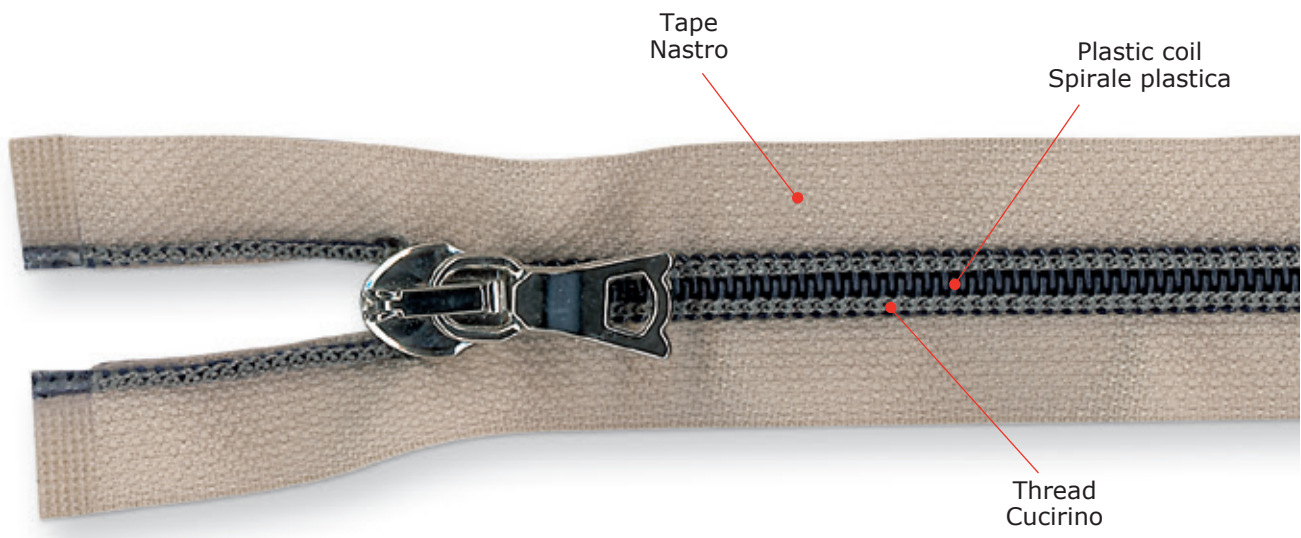

Fig. 1 - Mix



Fig. 2 - Metallizzata

Nylon Mix

Qui di seguito l'elenco dei colori di nastri, spirali e cucirini disponibili per le cerniere Nylon Mix:

Below the list of colors of tapes, coils and sewing yarns available for Nylon Mix zippers:

Cucirini	Spirali	Nastri
2132	2101	Tutti i colori abilitati per le cerniere nylon presenti sulla Color Card RIRI
2226	2118	
2118	2107	
2242	2127	
2220	2110	
2213	2230	
2101	2223	
2107	2226	
2127	2303	
2110	2403	
2216	2407	
2222	2411	
2223	2440	
2246	2513	
2225	2637	
2304	2642	
2311	2627	
2404	2750	
2406	2812	
2410	2827	
2518		
2417		
2450		
2642		
2618		
2647		
2627		
2640		
2721		
2733		
2745		
2715		
2702		
2637		
2750		
2807		
2817		
2823		
2828		
2712		
2221		
2133		
2112		
2705		

Sewing yarns	Coils	Tapes
2132	2101	All colors enabled for nylon zippers on RIRI Color Card
2226	2118	
2118	2107	
2242	2127	
2220	2110	
2213	2230	
2101	2223	
2107	2226	
2127	2303	
2110	2403	
2216	2407	
2222	2411	
2223	2440	
2246	2513	
2225	2637	
2304	2642	
2311	2627	
2404	2750	
2406	2812	
2410	2827	
2518		
2417		
2450		
2642		
2618		
2647		
2627		
2640		
2721		
2733		
2745		
2715		
2702		
2637		
2750		
2807		
2817		
2823		
2828		
2712		
2221		
2133		
2112		
2705		

metallic colors

	Nylon 4	Nylon 6	Nylon 10		Nylon 4	Nylon 6	Nylon 10
Z3 ORO				Z2 ORO VECCHIO			
Z5 ORO OPACO				Z6 RAME			
Z1 ARGENTO				Z4 ARGENTO OPACO			
Z0 BRUNITO				Z8 CANNA DI FUCILE			





Excellence in details