

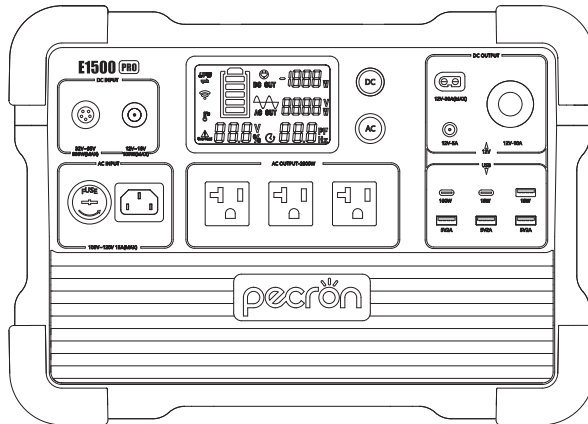

E1500 PRO



USER MANUAL

Please read the user manual thoroughly before using





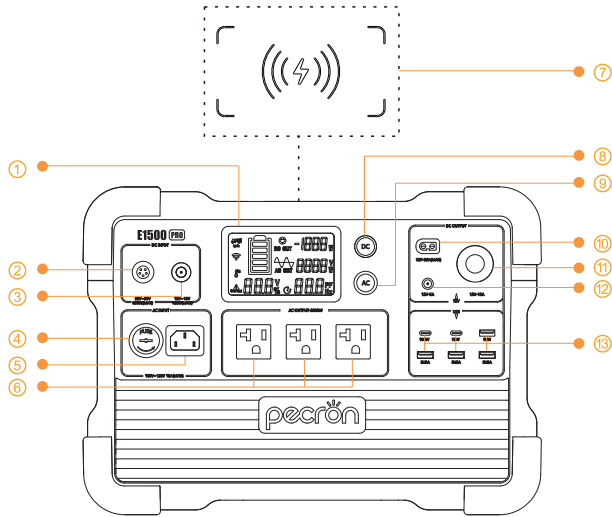

..... support@pecron.com

FUNCTION INTRODUCTION





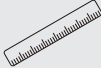



- ① LCD Display
- ② DC 32V~95V Charging Port
- ③ DC 12V~18V Charging Port
- ④ Fuse
- ⑤ AC 100V~120V Input
- ⑥ AC 100V~120V Output
- ⑦ Wireless Charger
- ⑧ DC 12V/USB/ Wireless Switch
- ⑨ AC 100V~120V Switch
- ⑩ DC12V XT60 Output
- ⑪ DC12V Auxiliary Output
- ⑫ DC12V(5525)Output
- ⑬ USB-A/USB-C Ports



SPECIFICATIONS

						
Capacity	Battery Type	Charging Time	Protections	Temperature	Dimension	Net Weight
1450Wh (51.8V28Ah)	Lithium-ion(NCM) 1000CycleLife>80%	AC: 1H to 80% 1.5H to100% PV/DC: 2H to100%	Over-Voltage, Overheat, Overload, Short-Circuit, Self-Recovery	0°C~45°C/32°F~113°F (Charging) -20°C~45°C/-4°F~113°F (Discharging)	L14.8*W9.4*H10.6 in L377*W238*H270 mm	Around 33.1lb Around 15Kg

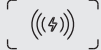
OUTPUT SPECS

						
AC Out*3	USB-A*4	USB-C*2	XT60 Output	Cigar Port	DC 5525 Output	Wireless Charger
Pure sine wave 100V~120V Rated 2000W	5V-2A*3 (5V,9V,12V, Max 18W)*1	(5V,9V,12V, Max 18W)*1 (5V,9V,12V,20V, Max 100W)*1	DC 12V-30A	DC 12V-10A	DC 12V-5A	Max 15W

INPUT SPECS

		
GX16MF	5521	AC Input
DC Charging(32V~95V) Max 800W	DC Charging(12V~18V) Max 100W	AC100V~120V

UPS SPECS

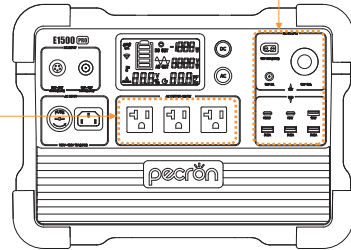
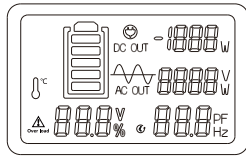

AC Input
AC100V~120V Max 15A

HOW TO USE THE E1500 PRO

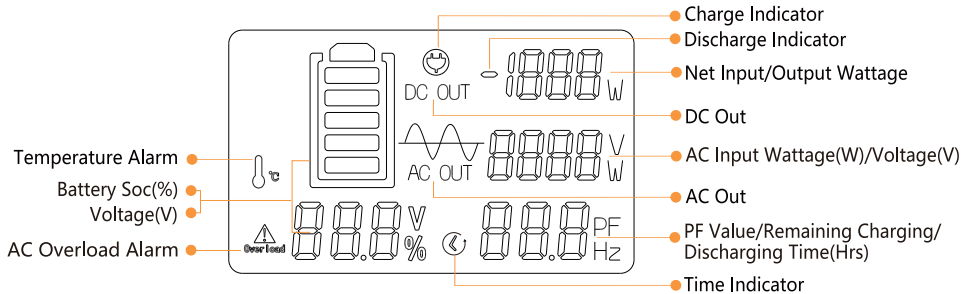

- Ⓢ press and hold to turn on / off DC / USB / Wireless Charger
- Ⓢ press and hold to turn on / off AC (Please turn off the AC function if there is no AC load on the unit)

LCD SMART DISPLAY



Temperature Alarm Icon







E1500 PRO can power your devices at temperatures ranging from -20~45°C.
If your working temperature is more than 45°C, the temperature alarm will flash, the unit may stop working.





AC Overload Alarm Icon

E1500 PRO can power most devices with power consumption less than 2000 watts.
If your device is more than 2000W, the AC overload alarm will flash, the power supply will stop working.



PACKING LIST

					
Pecron E1500 PRO*1	AC Charing Cable*1	MC4 Solar Charging Cable(LSMC4-5GX16)*1	Car Charging Cable*1	Anderson Solar Charging Cable*1	12V Alligator Clips*1

RECHARGE TIME

 Wall Charger	 Electric Generator	 Car Charger
Around 1.5Hours	Around 1.5Hours	Around 18Hours

SOLAR CHARGE TIME

	200W(×1) Recommended ★★★	400W(×2) Recommended ★★★★★	600W(×3) Recommended ☆	800W(×4) Recommended ★★★★★
	9~10 Hours	4~5 Hours	3~3.5 Hours	2~2.5 Hours

MC4 Solar Charging Cable

The solar charging time depends on weather conditions.E1500 PRO has a built-in MPPT charge controller that supports 32~95V, 15A PV charging up to 800W.

UPS Function

The E1500 PRO supports UPS function. It can provide the loads (such as computers, data centers, telecommunication equipment) near-instantaneous (within 8~20ms) protection from unexpected power interruptions of the main power supply.

Note: Not applicable to specific applications that need transfer time under 8ms, such as servers and workstations.

This UPS function only support protection for loads under 1600W, we recommend that you only connect one device at a time to avoid overload and thus result in protection failure.

Pecron is not responsible for any devices damage or loss of data resulting from failing to follow the instructions.

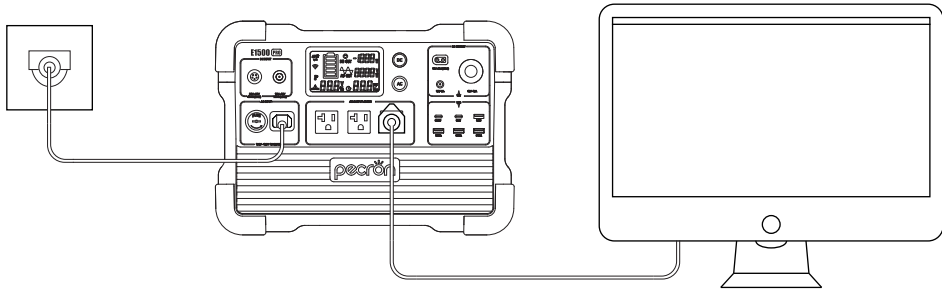

USING SOLAR PANELS TO CHARGE THE E1500 PRO

- DC5521 Charging Port:** PV/DC 12V~18V, 100W maximum; VOC(open circuit voltage) of solar panel must be less than 25V;
- GX16MF-5 Charging Port:** PV(operating voltage) range 32V~95V, 800W maximum; VOC(open circuit voltage) of solar panel/array must be less than 95V, otherwise, it will damage the unit! **Do not wire more than two 36V(AKA 24V) solar panels in series, or more than four 18V(AKA 12V) solar panels in series.**
(18V/36V stands for V_{mp} , the operating voltage, of the solar panel)
- If you have any questions, Please feel free to contact us: support@pecron.com**

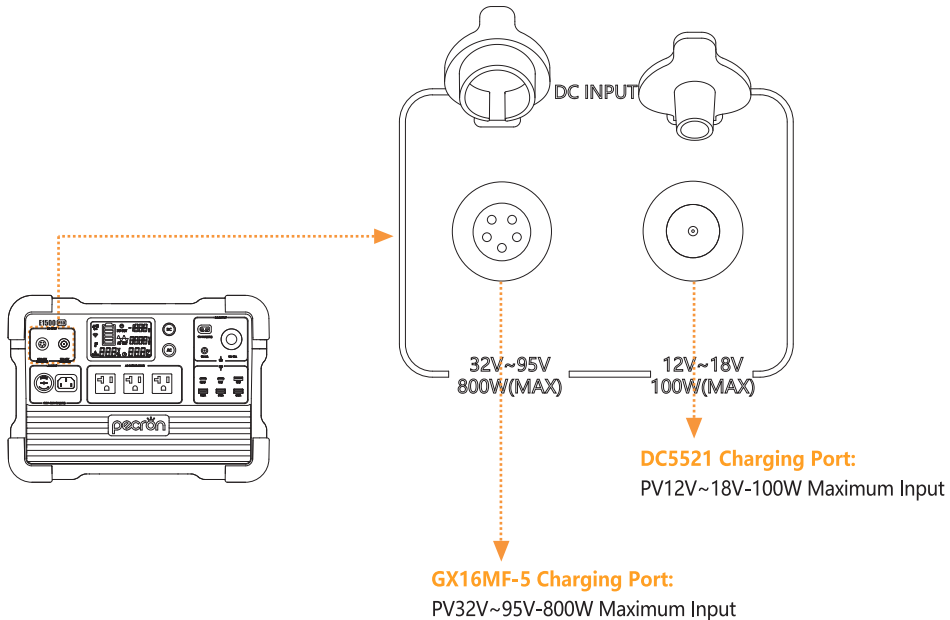

USING SOLAR PANELS TO CHARGE THE E1500 PRO

Using the pecron 100W /18V*1 (100W) to charge the E1500 PRO

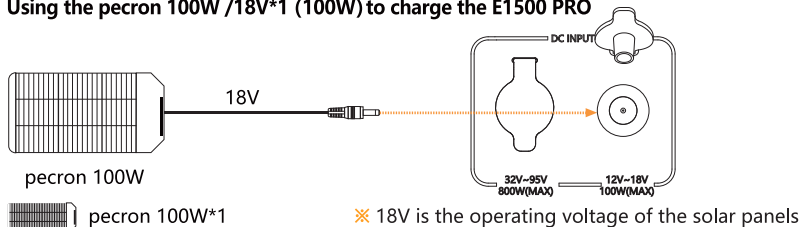

Using the pecron 200W /36V*1 (200W) to charge the E1500 PRO

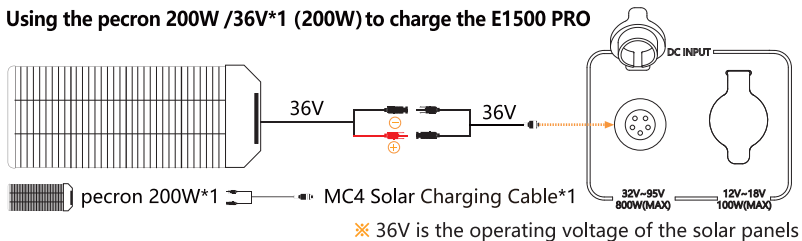

Using the pecron 200W /36V*2 (400W) to charge the E1500 PRO

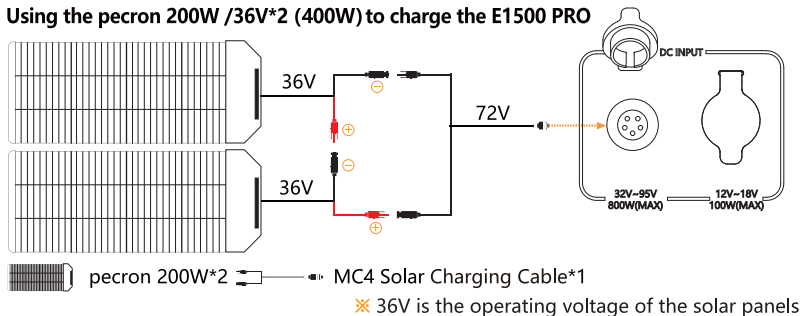

USING SOLAR PANELS TO CHARGE THE E1500 PRO

Using the pecron 200W /36V*3 (600W) to charge the E1500 PRO

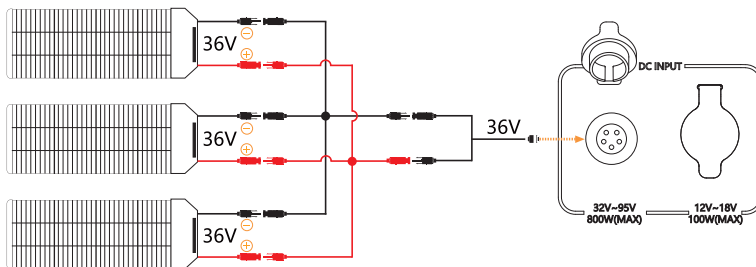

- pecron 200W*3
- MC4 Solar Charging Cable*1
- Y Branch MC4 Charging Cable(+)*1
- Y Branch MC4 Charging Cable(-)*1

(NOTE: This parallel charging cable sold separately)

※ 36V is the operating voltage of the solar panels

DO NOT wire three solar panels in series!

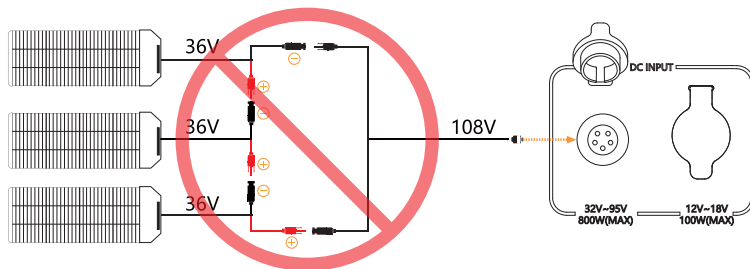

※ PV(GX16MF-5) Port Only work within 32V~95V Open Circuit voltage,exceeding 95V will damage the machine.

USING SOLAR PANELS TO CHARGE THE E1500 PRO

Using the pecron 200W /36V*4 (800W) to charge the E1500 PRO

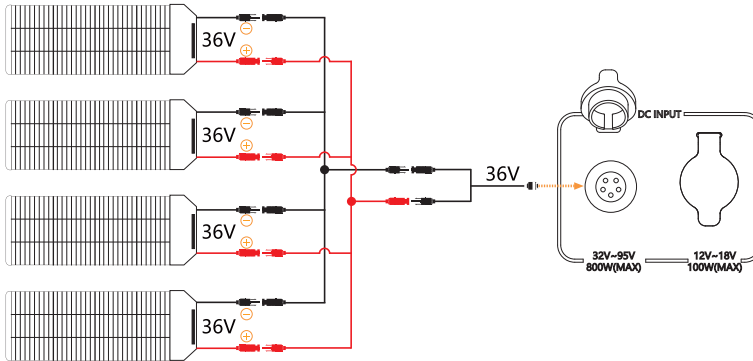

 pecron 200W*4  MC4 Solar Charging Cable*1

 Y Branch MC4 Charging Cable(+)*1

 Y Branch MC4 Charging Cable(-)*1





(NOTE: This parallel charging cable sold separately)

※ 36V is the operating voltage of the solar panels

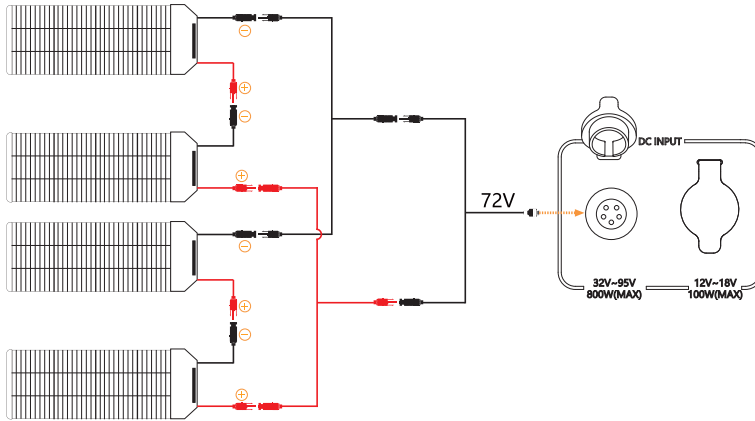
USING SOLAR PANELS TO CHARGE THE E1500 PRO

Using the pecron 200W /36V*4 (800W) to charge the E1500 PRO



-  pecron 200W*4
-  MC4 Solar Charging Cable*1
-  Y Branch MC4 Charging Cable(-)*1
-  Y Branch MC4 Charging Cable(+)*1

(NOTE: This parallel charging cable sold separately)

※ 36V is the operating voltage of the solar panels

DO NOT wire four solar panels in series!

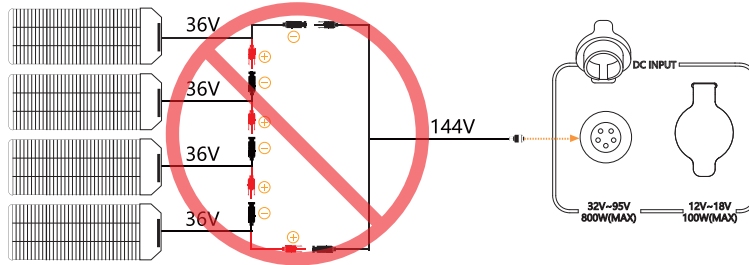

※ PV(GX16MF-5) Port Only work within 32V~95V Open Circuit voltage,exceeding 95V will damage the machine.

FAQS

Q1: What kind of battery is used in E1500 PRO? How long it can last?

A: E1500 PRO utilizes high quality UL certified automotive battery cell, it can retain 80% efficiency at 1000 complete charge cycles.

Q2: What devices can E1500 PRO power?

A: Please note that the AC output port can only charge or power devices that operate at less than 2000W.
DC output port can only charge or power that operate at less than 12V-30A.

Q3: Can the E1500 PRO be used as UPS?

A: E1500 PRO supports UPS function with an automatic switchover time of 8~12ms.

Q4: How to calculate the E1500 PRO running time?

A: Running Time=Total Capacity(1450Wh) * 0.85 (Depth of Discharge)/Loading Power(Watts)

Q5: Can I use the E1500 PRO indoors and charge the E1500 PRO indoors?

A: Yes, the E1500 PRO is safe to use indoors.

Q6: Does E1500 Pro have built-in MPPT charge controller?

A: Yes, there are two independent built-in MPPT charge controllers; "5521" port supports 12~18V(Max 100W) PV input, and "GX16MF" port supports 32~95V(Max 800W) PV input.

Q7: What kind of maintenance does E1500 PRO require?

A: Charging E1500 PRO in time when the battery running low; And please charge it at least once for every six months even if it is not being used.

Q8: How to store the E1500 PRO?

A: Do not store, charge or use E1500 PRO near heat sources, or in an area exposed to flammable or corrosive gas; Do not immerse in water. Keep away from liquids and store it in a cool and dry place.

DISCLAIMER

Please read the user manual thoroughly before using this product, and keep this manual in a safe place for future reference. Failure to follow the instructions for proper set up, use, and care for the device can increase the risk of serious personal injury, death, or property damage. Once you use this device, you are deemed to have understood, recognized and accepted all terms and contents of this document. The user shall be responsible for his own actions and all consequences arising from failure to use the device in accordance with the "User Manual" , or as authorized in Pecron's current product literature. In compliance with laws and regulations, Pecron reserves all rights for final explanation, and to change these terms and conditions at any time without prior notice. In the event that any revisions are made, the revised terms and conditions shall be posted on our website immediately, please visit our website to inform yourself of any changes.

WARNING

- 1、 Do not place the device near heat source, such as a fire or a heating furnace.
- 2、 Do not immerse in any liquid, or expose the unit to rain or wet conditions.
- 3、 Do not use the battery in a strong static electricity or electromagnetic environment.
- 4、 Do not disassemble or puncture the product with sharp objects in any way.

- 5、 Short circuits can be caused by: vermin or pests chewing through wires; water or other fluids coming into contact with electrical wiring.
- 6、 Do not use accessories or parts other than those provided by Pecron. Please visit our website www.pecron.com or reach our support team for a complete list of accessories and parts.
- 7、 When using this product, please strictly follow the ambient temperature for use in the user manual. If the temperature is too high, the battery can potentially result in self-combustion and will burst into flames, which can cause widespread damage. If the temperature is too low, the performance of the battery will be seriously degraded, and it may even fail to meet the normal use requirements.
- 8、 Do not stack heavy objects on this product.
- 9、 Do not block the air vents during use, or leave the device in a non-ventilated or dusty space.
- 10、 Please avoid impacts, fall off, and violent vibration. Please turn off the device immediately and stop using it in the event of major exterior impact. Please fasten the unit firmly during transportation to avoid vibration and impact.
- 11、 In the event of immersing the device into the water accidentally, please place the unit in a safe open area and keep away from the unit until it is completely dry. The dried unit should not be reused and should be disposed of properly according to the local regulation. If the device catches fire, use the fire extinguishing equipment in the following recommended order: water or mist, sand, fire blanket, dry chemical, carbon dioxide fire extinguisher.
- 12、 Please wipe it with a dry cloth to clean the surface of the device.
- 13、 Please place this device with care to prevent the product from being damaged due to fall off. If the product is damaged due to fall off, please turn off the unit immediately and place it in an open area, keep away from combustibles and crowds, and dispose of in accordance with local laws and regulations.
- 14、 Please store this device in a place out of reach of children and pets.

DISPOSAL

- 1、 When conditions permit, please be sure to completely discharge the battery of this product, and then put the product in the designated battery recycling box. This product contains batteries. Batteries are dangerous chemicals and are strictly prohibited from being disposed of in ordinary trash. For details, please follow local laws and regulations on battery recycling and disposal.
- 2、 If the battery cannot be completely discharged due to the failure of the product itself, please do not dispose of the battery directly in the battery recycling box, and contact a professional battery recycling company for further disposal.
- 3、 The battery will not be able to start after being over-discharged, please dispose of it according to the principle of disposal.

EXCLUSIONS

Pecron's warranty does not apply to:

Misused, abused, modified, damaged by accident, or used for anything other than normal consumer use as authorized in Pecron's current product literature.

CUSTOMER SUPPORT: support@pecron.com

WEBSITE: www.pecron.com

PECRON.LLC



POWER IT POSSIBLE

www.pecron.com

..... support@pecron.com