

pecron

E2000 LFP

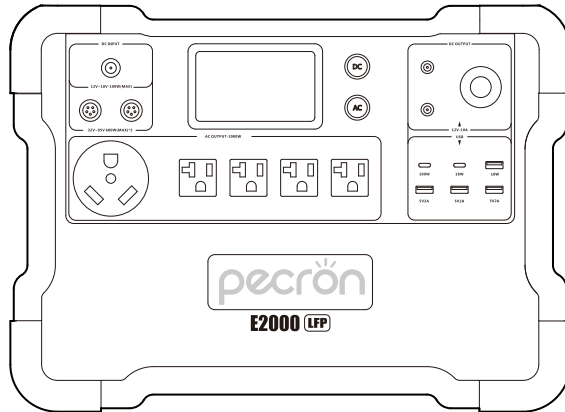

USER MANUAL

Please read the user manual thoroughly before using

support@pecron.com

FUNCTION INTRODUCTION

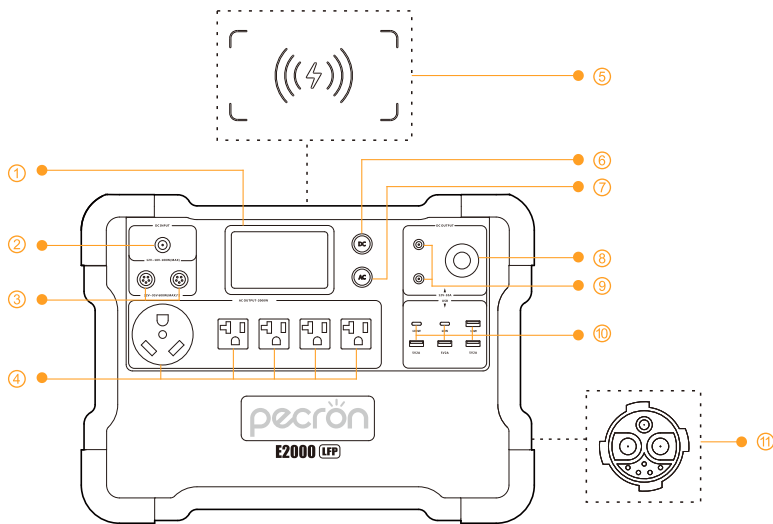

① LCD Display

⑤ Wireless Charger

⑨ DC12V(5525)Output

② DC 12V~18V Charging Port

⑥ DC 12V/USB/ Wireless Switch

⑩ USB-A/USB-C Ports

③ DC 32V~95V Charging Port







⑦ AC 100V~120V Switch

⑪ Battery Expansion Port







④ AC 100V~120V Output

⑧ DC12V Auxiliary Output



SPECIFICATIONS

 Capacity	 Battery Type	 Charging Time	 Protections	 Temperature	 Dimension	 Net Weight
1920Wh (25.6V75Ah)	LiFePO4 Battery Retain 80%+ Original Capacity At 3500 Cycles	3.5~4H (Standard) 1.5~2H (Fast Charging)	Over-Voltage, Overheat, Overload, Short-Circuit, Self-Recovery	0°C~45°C/32°F~113°F (Charging) -20°C~45°C/-4°F~113°F (Discharging)	L16.1*W10*H11.6 in L409*W256*H297 mm	Around 48.5lb Around 22Kg

OUTPUT SPECS

 AC Out*5	 USB-A*4	 USB-C*2	 DC 5525 Output*2	 Cigar Port*1	 Wireless Charger*1
Pure sine wave 100V~120V Rated 2000W	5V-2A*3 (5V,9V,12V, Max 18W)*1	(5V,9V,12V, Max 18W)*1 (5V,9V,12V,20V, Max 100W)*1	DC 12V-3A	DC 12V-10A	Max 15W

INPUT SPECS

 GX16MF*2	 5521*1
DC Charging(32V~95V) Max 1200W(600W*2)	DC Charging(12V~18V) Max 100W

HOW TO USE THE E2000 LFP

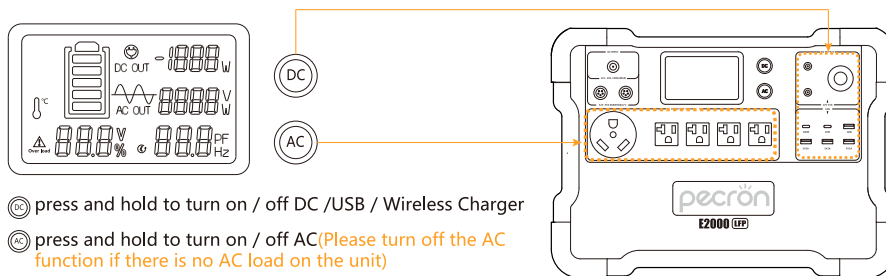

- Ⓢ press and hold to turn on / off DC /USB / Wireless Charger
- Ⓢ press and hold to turn on / off AC(Please turn off the AC function if there is no AC load on the unit)

LCD SMART DISPLAY

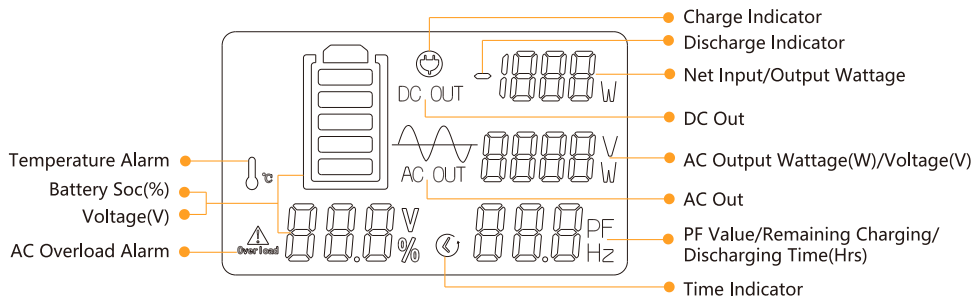

🌡️ Temperature Alarm Icon

E2000 LFP can power your devices at temperatures ranging from -20~45°C.

If your working temperature is more than 45°C, the temperature alarm indicator will flash,the unit may stop working.



⚠️ AC Overload Alarm Icon

E2000 LFP can power most devices with power consumption less than 2000 watts.

If your devices exceed 2000W, The AC overload alarm indicator will flash, The unit will stop supplying power.

EXPANDABLE BATTERY

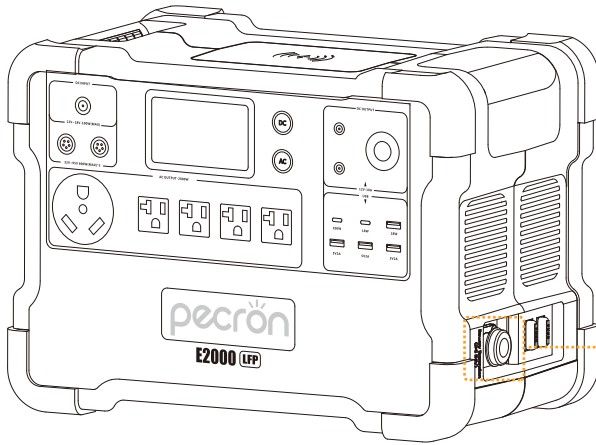

Require PECRON battery expansion cable to expand the capacity by adding extra PECRON 24V battery.

Do not expand with any battery modules other than the PECRON's, this could damage the unit!

Battery Expansion
(DC 24V)

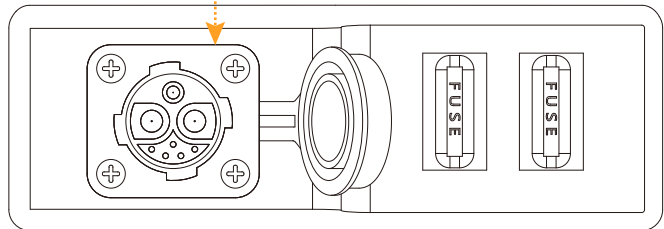

HOW TO SET THE POWER ON THE E2000 LFP SCREEN TO THE TOTAL POWER AFTER CASCADING THE E2000 LFP AND EB3000-24V?

1: Press and hold DC for seven seconds in the off state to enter the setting item.

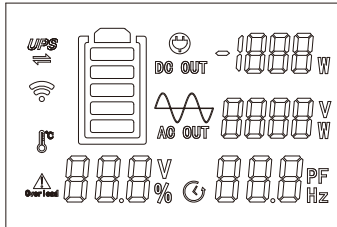

2: Under a number-001, you will see the number of the extra battery packs, which is 0 by default. It can be set according to the number of connected battery packages - shortly press DC to increase the number and shortly press AC to decrease the number.

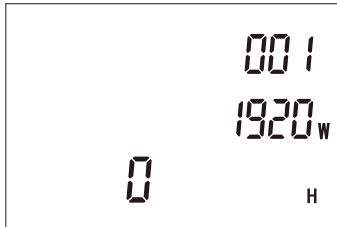

3: Long press AC to enter the process 002, the default value is L3, this means screen brightness. Shortly press DC can increase the brightness or shortly press AC to decrease the brightness.

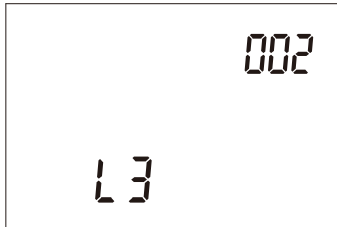

4: Long press AC to enter the setting of item 003. The default value is OFF, which means the automatic shutdown time of the machine without any load. Shortly press DC can increase the time or shortly press AC to decrease the time.



5: Long press AC to enter the setting of item 004, the default value is 60Hz. This is the AC output frequency, do not modify it.

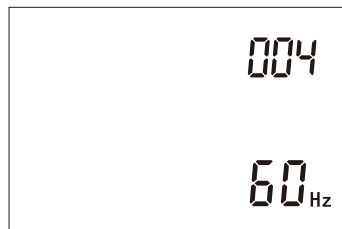



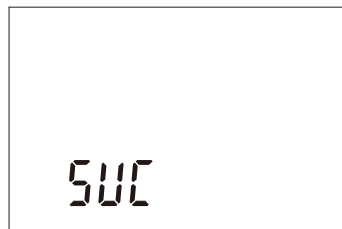

6: Long press AC to exit the setting. You will see a word of **SUC** if the setting is successful.



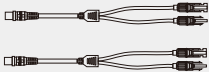

※ Without setting, the E2000 LFP will only display the power of the unit and the usage time of the power of the machine.

PACKING LIST



			
PECRON E2000 LFP*1	AC Charger*1	MC4 Solar Charging Cable(LSMC4-5GX16)*2	Car Charging Cable*1

RECHARGE TIME

 Wall Charger	 Electric Generator	 Car Charger
Around 3.5~4 Hours Around 1.5~2Hours(2 adapters)	Around 3.5~4 Hours Around 1.5~2Hours(2 adapters)	Around 20Hours

※ Includes one AC charger, extra one can be purchased on our website if needed.

SOLAR CHARGE TIME

 PECRON solar panel	200W (×1) Recommended ★	400W (×2) Recommended ★★★	600W (×3) Recommended ☆	800W (×4) Recommended ★★★★★	1200W (×6) Recommended ★★★★★
 MC4 Solar Charging Cable	15~16 Hours	7~8 Hours	5~6 Hours	3~4 Hours	2~3 Hours

The solar charging time depends on weather conditions. E2000 LFP has a built-in MPPT charge controller that supports 32V~95V, 15A PV charging up to 1200W.

USING SOLAR PANELS TO CHARGE THE E2000 LFP

- 1x DC5521 Charging Port:** PV/DC 12V~18V, 100W maximum; VOC(open circuit voltage) of solar panel must be less than 25V;
- 2x GX16MF-5 Charging Port:** PV(operating voltage) range 32V~95V, 600W maximum; VOC(open circuit voltage) of solar panel/array must be less than 95V, otherwise, it will damage the unit! **Do not wire more than two 36V solar panels in series, or more than four 18V solar panels in series.**
(18V/36V stands for V_{mp} , the operating voltage, of the solar panel)
- 3. If you have any questions, feel free to contact us: support@pecron.com**

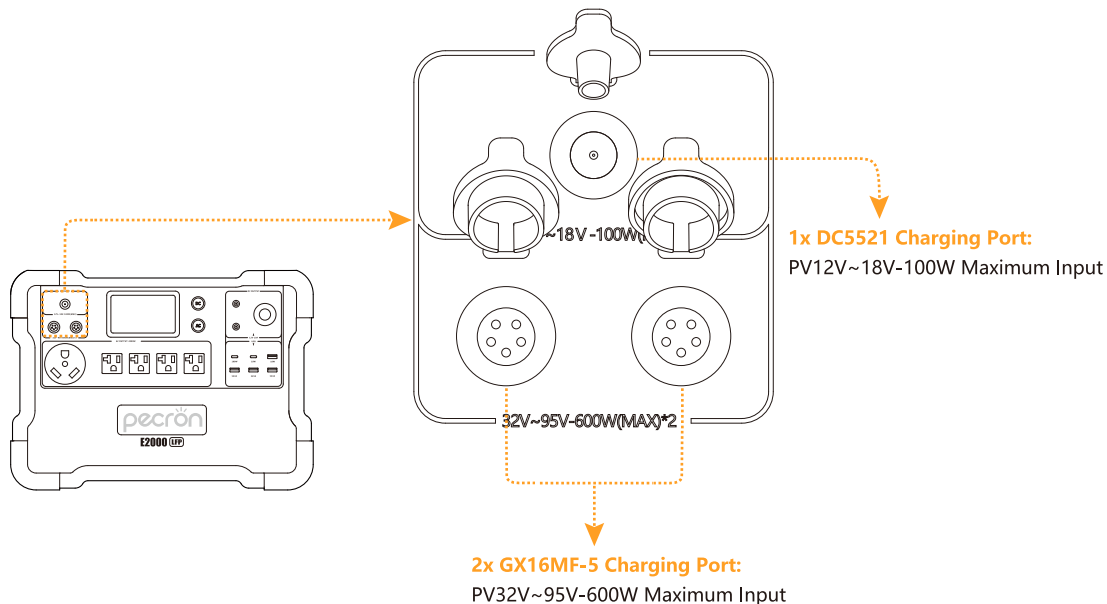

USING SOLAR PANELS TO CHARGE THE E2000 LFP

Using the PECRON 100W /18V*1 (100W) to charge the E2000 LFP

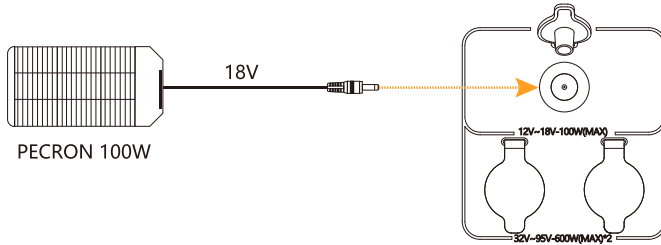

 PECRON 100W*1

※ 18V is the operating voltage of the solar panels

Using the PECRON 200W /36V*1 (200W) to charge the E2000 LFP

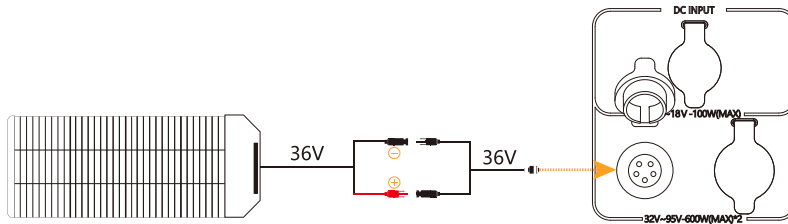

 PECRON 200W*1  MC4 Solar Charging Cable*1

※ 36V is the operating voltage of the solar panels

USING SOLAR PANELS TO CHARGE THE E2000 LFP

Using the PECRON 200W /36V*2 (400W) to charge the E2000 LFP

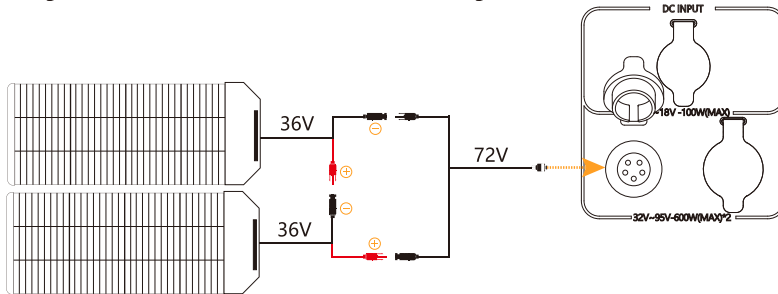

PECRON 200W*2



MC4 Solar Charging Cable*1

※ 36V is the operating voltage of the solar panels

Using the PECRON 200W /36V*2 (400W) to charge the E2000 LFP

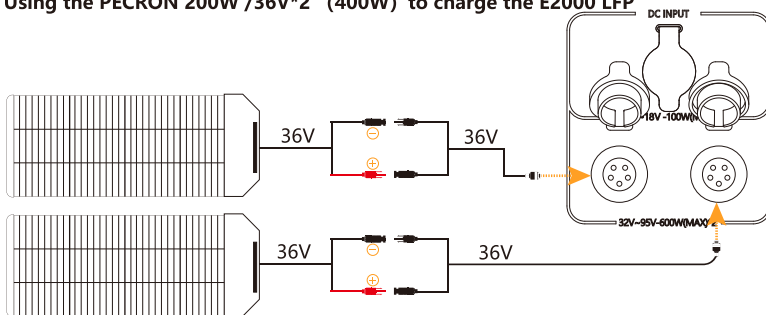

PECRON 200W*2



MC4 Solar Charging Cable*2

※ 36V is the operating voltage of the solar panels

USING SOLAR PANELS TO CHARGE THE E2000 LFP

Using the PECRON 200W /36V*3 (600W) to charge the E2000 LFP

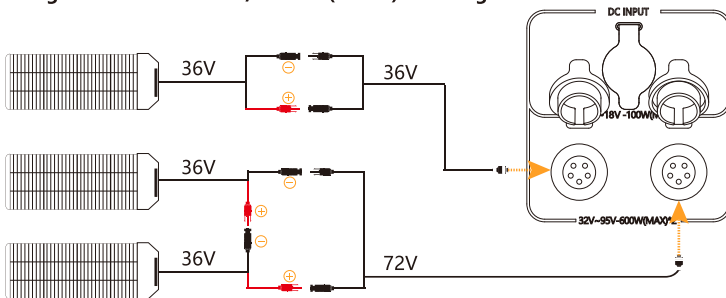

PECRON 200W*3 MC4 Solar Charging Cable*2

※ 36V is the operating voltage of the solar panels

DO NOT wire three solar panels in series!

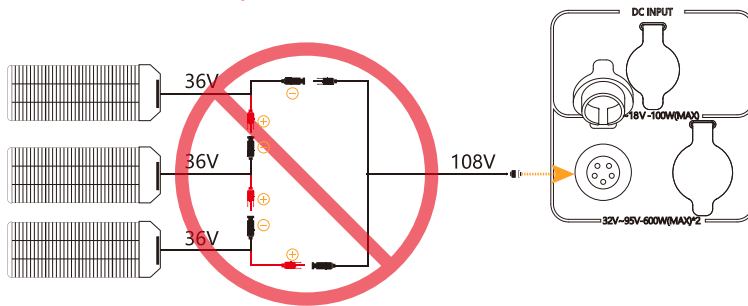

※ PV(GX16MF-5) Port Only work within 32V~95V Open Circuit voltage,exceeding 95V will damage the machine.

USING SOLAR PANELS TO CHARGE THE E2000 LFP

Using the PECRON 200W /36V*4 (800W) to charge the E2000 LFP

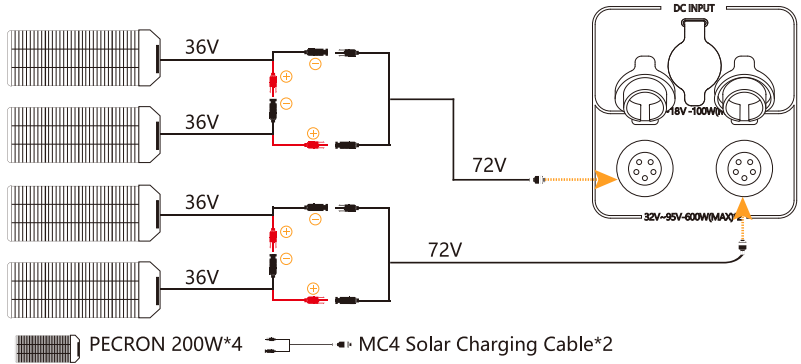

※ 36V is the operating voltage of the solar panels

DO NOT wire four solar panels in series!

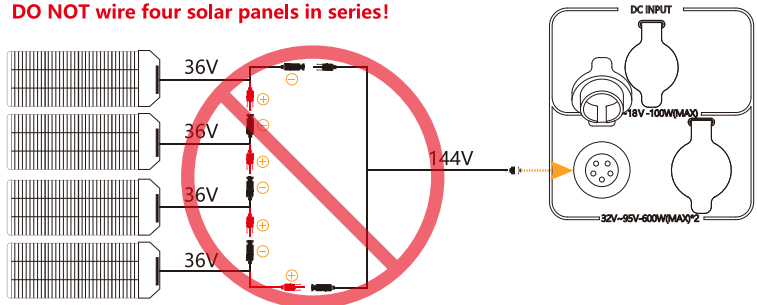

※ PV(GX16MF-5) Port Only work within 32V~95V Open Circuit voltage,exceeding 95V will damage the machine.

USING SOLAR PANELS TO CHARGE THE E2000 LFP

Using the PECRON 200W /36V*6 (1200W) to charge the E2000 LFP

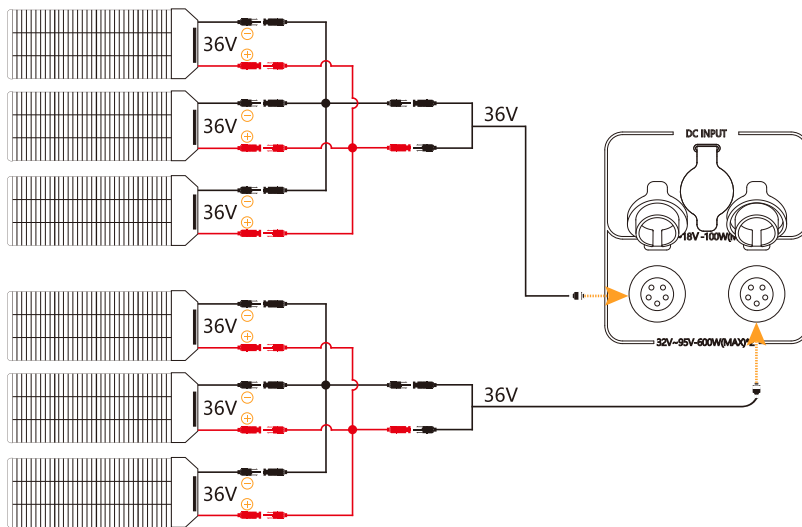

PECRON 200W*6

MC4 Solar Charging Cable*2

Y Branch MC4 Charging Cable(+)*2

Y Branch MC4 Charging Cable(-)*2

※ 36V is the operating voltage of the solar panels

FAQS

Q1: What kind of battery is used in E2000 LFP? How long it can last?

A: E2000 LFP utilizes high quality UL certified automotive LiFePO4 battery, it can retain 80% of its original capacity at 3500 complete charge cycles.

Q2: What devices can E2000 LFP power?

A: E2000 LFP can power most devices with power consumption less than 2000 watts.

Q3: Can the E2000 LFP be used as UPS?

A: The UPS function is not supported.

Q4: Can the E2000 LFP be charged while discharging?

A: Yes, E2000 LFP can run devices while it is being charged. The battery will eventually run out if the discharging is greater than the charging during the pass through charging.

Q5: How to calculate the E2000 LFP running time?

A: Running Time=Total Capacity(1920Wh) * 0.85 (Depth of Discharge)/Loading Power(Watts)

Q6: Can I use the E2000 LFP indoors and charge the E2000 LFP indoors?

A: Yes, the E2000 LFP is safe to use indoors.

Q7: Does E2000 LFP have built-in MPPT controller?

A: Yes, there are two independent 600W(PV 32V-95V) MPPT charge controllers inside, and one step up 100W(PV 18V) MPPT charge controller, The Voc (Open Circuit Voltage) of the solar panels should not exceed 95V.

Q8: How to store the E2000 LFP?

A: Please turn off the unit and then store it in a dry, ventilated place at normal room temperature. Do not place this unit near water sources or a wet/moist environment. For long-term storage, it is recommended to discharge the battery to 30% every three months and recharge it to 60% to sustain the battery life.

DISCLAIMER

Please read the user manual thoroughly before using this product, and keep this manual in a safe place for future reference. Failure to follow the instructions for proper set up, use, and care for the device can increase the risk of serious personal injury, death, or property damage. Once you use this device, you are deemed to have understood, recognized and accepted all terms and contents of this document. The user shall be responsible for his own actions and all consequences arising from failure to use the device in accordance with the "User Manual" , or as authorized in PECRON's current product literature.

In compliance with laws and regulations, PECRON reserves all rights for final explanation, and to change these terms and conditions at any time without prior notice. In the event that any revisions are made, the revised terms and conditions shall be posted on our website immediately, please visit our website to inform yourself of any changes.

WARNING

1. Do not place the device near heat source, such as a fire or a heating furnace.
2. Do not immerse in any liquid, or expose the unit to rain or wet conditions.
3. Do not use the battery in a strong static electricity or electromagnetic environment.
4. Do not disassemble or puncture the product with sharp objects in any way.
5. Short circuits can be caused by: vermin or pests chewing through wires; water or other fluids coming into contact with electrical wiring.
6. It's prohibited to be used as car jump starter, only can be used to charge the car battery.
7. Do not use accessories or parts other than those provided by PECRON. Please visit our website www.pecron.com or reach our support team for a complete list of accessories and parts.
8. When using this product, please strictly follow the ambient temperature for use in the user manual. If the temperature is too high, the battery can potentially result in self-combustion and will burst into flames, which can cause widespread damage. If the temperature is too low, the performance of the battery will be seriously degraded, and it may even fail to meet the normal use requirements.

- 9、 Do not stack heavy objects on this product.
- 10、 Do not block the air vents during use, or leave the device in a non-ventilated or dusty space.
- 11、 Please avoid impacts, fall off, and violent vibration. Please turn off the device immediately and stop using it in the event of major exterior impact. Please fasten the unit firmly during transportation to avoid vibration and impact.
- 12、 In the event of immersing the device into the water accidentally, please place the unit in a safe open area and keep away from the unit until it is completely dry. The dried unit should not be reused and should be disposed of properly according to the local regulation. If the device catches fire, use the fire extinguishing equipment in the following recommended order: water or mist, sand, fire blanket, dry chemical, carbon dioxide fire extinguisher.
- 13、 Please wipe it with a dry cloth to clean the surface of the device.
- 14、 Please place this device with care to prevent the product from being damaged due to fall off. If the product is damaged due to fall off, please turn off the unit immediately and place it in an open area, keep away from combustibles and crowds, and dispose of in accordance with local laws and regulations.
- 15、 Please store this device in a place out of reach of children and pets.

DISPOSAL

- 1、 When conditions permit, please be sure to completely discharge the battery of this product, and then put the product in the designated battery recycling box. This product contains batteries. Batteries are dangerous chemicals and are strictly prohibited from being disposed of in ordinary trash. For details, please follow local laws and regulations on battery recycling and disposal.
- 2、 If the battery cannot be completely discharged due to the failure of the product itself, please do not dispose of the battery directly in the battery recycling box, and contact a professional battery recycling company for further disposal.
- 3、 The battery will not be able to start after being over-discharged, please dispose of it according to the principle of disposal.

EXCLUSIONS

PECRON's warranty does not apply to:

Misused, abused, modified, damaged by accident, or used for anything other than normal consumer use as authorized in PECRON's current product literature.

CUSTOMER SUPPORT: support@pecron.com

WEBSITE: www.pecron.com

PECRON.LLC

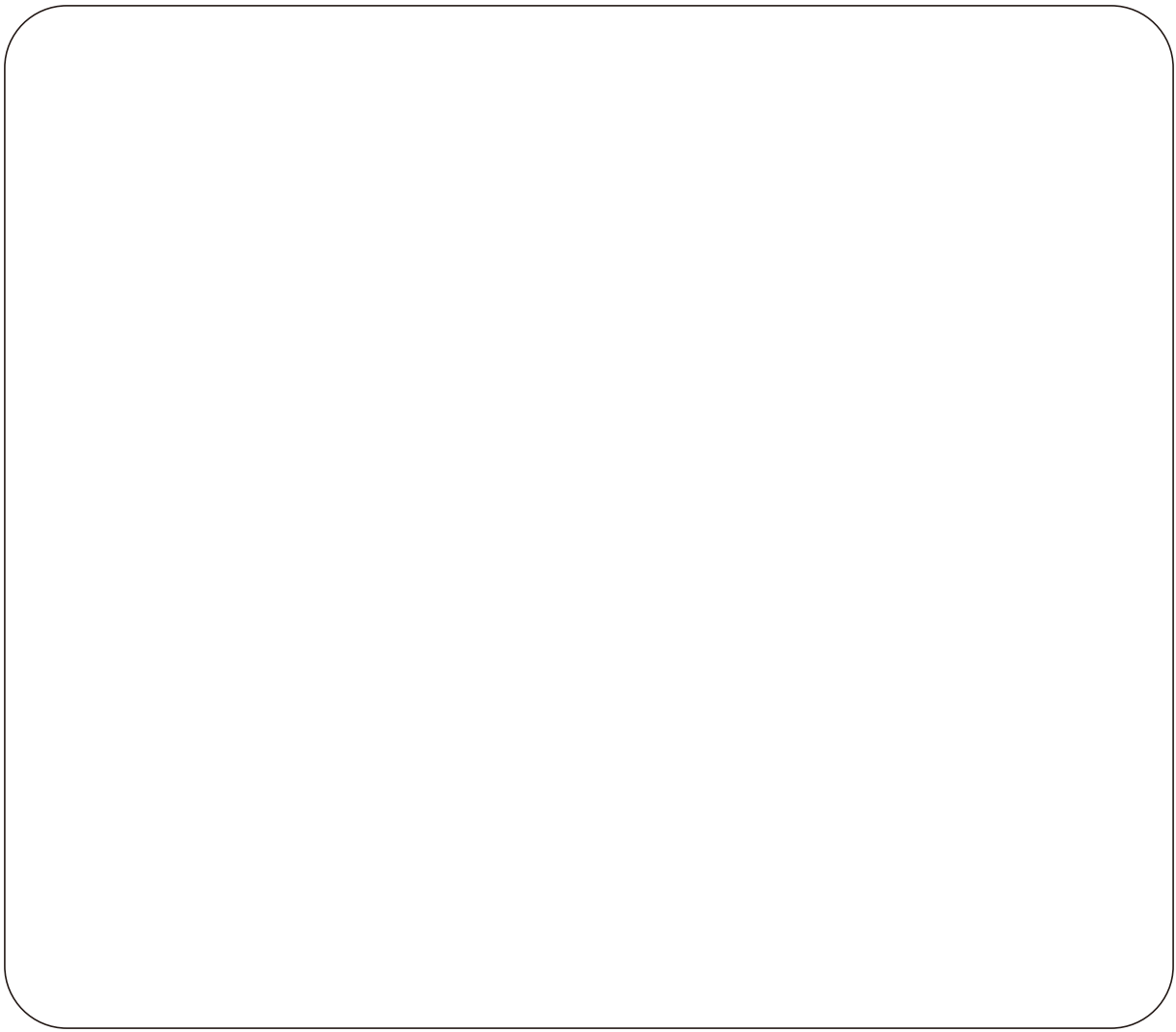



POWER IT POSSIBLE

www.pecron.com

..... support@pecron.com