

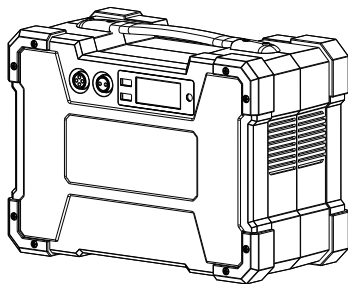

PORTABLE POWER STATION E1000/E1500



User manual

Please read the manual carefully before you use!

Please keep the manual carefully so that you can check it for usage in the future.

And please read the manual carefully to avoid unnecessary damage of the portable power station.

Please read the following information before you use the power unit.

To ensure the safety of use and avoid damage to the power pack, please first read the Safety Precautions (pages 1-3) and the Handling Precautions (page 3-5). Please also read this manual carefully to ensure proper use of the portable power station.

Please refer to this manual while using the power unit to familiar with the use of the device.

When you reading this manual, please try to charge the device and familiarize yourself with the operating procedures of the power supply. This will give you a better understanding of our power unit Please be sure to keep the manual so that you can refer it again when you need it.

Please read the instructions carefully before use.

Our company does not assume any responsibility for any damage to your equipment caused by incorrect use of the power supply.

User Manual

Thank you for purchasing and using our products. In order to ensure the safe and correct use of this product, please read the user manual carefully before operating.

- This printed manual is a basic instruction manual.
- This manual only applies to portable power station of E1000/E1500.
- Due to product improvement and upgrading, the contents of product specifications and manuals may be changed without notice.
- The images and screen shots used in this manual may differ from the actual product.
- Copyright - it is strictly prohibited to copy the contents of this manual without permission.

Editing routine in the manual

(Page **):Reference page for more information



:warnings about problems with the power supply



:Additional information



:Tips or advice for better use of the portable power station



:Suggestions for troubleshooting

Content

Safety Precautions	1
Handling Precautions (Reserve and Use of Equipment Correctly)	3
List of the product	6
Product introduction	7
Product specifications	8
Introduction of the parts and functions	9
Operation instructions and precautions	11
How to charge the battery	12
How to use AC output	14
How to use DC output	16
Misuse and countermeasures	17
Warranty and after-sale service	18
Certificate of qualification	20
Statement for poisonous and harmful substance of the power unit	21
Copyright	22

Safety Precautions

To protect yourself and others from harm and to protect your equipment from damage, please read all the following information carefully before using your equipment.

Warnings:

1. Do not put the battery in the fire or heat the power and do not store the power in high temperature environment.
2. Do not put the power supply into the water. Keep it in a cool and dry place during storage.
3. Do not use the power supply in flammable or explosive environments such as gasoline, gas, chemical preparations, or mines, as this may endanger your safety.
 - Operate according to regulations, instructions and signs in potentially explosive environments.
 - Do not store or carry flammable liquids, gases, or explosive materials in boxes that is containing power supplies and power accessories.
4. Do not use the power supply in a corrosive environment, otherwise the power supply may be damaged.
5. Do not apply paint or stickers to the power supply. Paints and stickers can clog equipment parts and prevent proper use. If you are allergic to paint or metal parts of your equipment, it may cause itching, eczema, or skin swelling. When this happens, please stop using and see a doctor.

6. Make sure that the heat dissipation is at least 5cm around the power supply.

7. Do not disassemble, modify or repair the power supply. Any changes or modifications made to the equipment will not be warranted by the manufacturer. For repairs, please contact the dealer where you purchased the product.

8. Do not use a charger that is not approved by the manufacturer to charge the power supply.

9. Do not use the device in thunderstorms. This may cause the malfunction of the device and maybe increase the risk of electric shock.

10. Handle and dispose of power and its charging adapter carefully.

- Use only chargers that are specifically designed for the device and approved by our company. Unmatched chargers may cause danger or damage the device.
- Do not throw battery into fire. When disposing of waste power, please comply with local and national regulations.
- Do not place the battery or device inside or on top of a heating device (such as a microwave oven, oven, or radiator). Battery overheating may explode.
- Do not squeeze or puncture the power supply and battery. Do not subject the battery to external high voltage, which may cause internal short circuit and overheating.

11. Protect the power supply and charger from damage.

- Avoid exposing the power supply to extremely cold or hot temperatures.

- Extreme temperatures can damage the device, reduce its charging capacity, and shorten the life of the power supply.
- Do not use a damaged charger.

Handling Precautions (Custody and Use of Equipment Correctly)

Keep the power supply dry

- Moisture and liquids can damage equipment components or circuits.
- Do not switch on the device when it is wet. If the device is turned on, turn it off immediately (if the device does not turn off, please maintain the status quo).
- If the liquid enters the power source, it will damage the internal parts of the device, and the manufacturer will not guarantee this.

Do not use or store equipment in dusty or dusty areas

Dust can cause equipment malfunction, fire or electric shock.

Equipment can only be stored on a flat surface

If the device falls, it will be damaged

Do not store the device in hot or cold places. Use the equipment within the range between -20°C and 45°C

- If the device is placed in a closed vehicle, the device may

be in a dangerous state because the internal temperature of the vehicle can reach as high as 80°C during the summer.

- Do not expose the power supply to direct sunlight for long periods of time, such as on the dashboard of a car.
- When charging the power supply, the operating temperature should be guaranteed between 0 °C and 45 °C

Do not store equipment near or inside water heaters, microwave ovens, hot cooking equipment or high pressure vessels

- Equipment may be overheated and this may cause a fire.

Do not slide or crash the device

- This may damage the device's screen. If you bend or deform it, it may damage the device or the part may malfunction.

When cleaning equipment

- Wipe the device or charger with a towel or eraser
- Do not use chemicals or cleaners

How to ensure maximum life for the battery and charger

- If the multi-functional emergency power pack is idle for a long time, the power of the battery may be run out.

Therefore, please make sure to charge the power supply every 6 months.

- After long-term storage, when using the power again, please fully charge it first. (the power display will show,

100% for the battery capacity, but the actual battery power will be less than 100% due to self-consumption of the battery, and the long-term loss of the control panel)

- When the charger is not in use, please disconnect the power.
- Battery can only be used for specific purposes.
- To make the battery life longer, please don't run off the power of the battery to 0% when using it, and it's better to recharge it when the battery is 10% remaining.

Please use original accessories of our company to ensure the best performance.

- Our company will not be responsible for any damage to the product or any accidents (such as fire) caused by using accessories that are not original from the company. (such as battery leakage or explosion)
- Please note that any failure of this product caused by the use of accessories that are not original is not covered by the warranty of this product, but the user can pay for repairs.
- Our company will not take any responsibility for the malfunction or accident caused by using an incompatible charger or product.

If there is any malfunction, problem or damage to this product, please contact the dealer where you purchased the product.

Product list

Please check if the following standard items are included in the power after you buy our product. If there is a standard item missed, please contact the dealer. (Optional accessories should be explained with the manufacturer or distributor before purchase if necessary.)

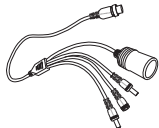
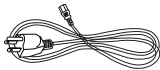
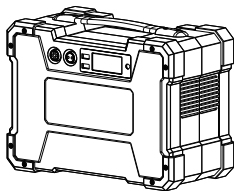
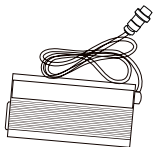

Charging adapter

Charging cable

4 in 1 DC output cable

NO.	Packing list	Quantity
1	E1000/E1500 portable power station	1
2	Charging adapter	1
3	Charging cable	1
4	4 in 1 DC output cable	1
5	Car charger(optional)	1
6	Manual and warranty card	1
7	Accessories Bag	1

Product Introduction

E1000/E1500 is a multiple functional off-line portable power station which is designed with the safe lithium-ion battery and inverter technology. It's very easy to carry and convenient offering power to electrical appliances with advantages of light weight, large capacity , high power and multiple functions; It is applied to a variety of intelligent products,such as mobile phone ,satellite phone, digital camera,mobile hard disk, tablet computer, LED lamp, laptop computer, car boot ,outdoor lighting. And it can also be used in the following fields like outdoor activities, media, tourism, and somewhere lacking of advanced technology.

The following examples illustrate the power and standby time of some common appliances

E1000/E1500 Supply power to other appliances by :

Smart Phone (8-10Wh) : charging for more than 109/160 times

Tablet(16-25Wh) : charging for more than 55/80 times

Laptop(50Wh) : charging for more than 17/26 times

Car refrigerator(30-60W) : 15-29/21-43 hours

Product parameters

Model	E1000	E1500
Rated output power	1000W	1500W
Peak power	2000W	3000W
Output voltage	AC pure-sine wave AC110V60Hz	
	DC 12V10A USB 5V2A(QC3.0)	
Battery type	Lithium-ion battery	
Battery capacity	1028.16Wh (25.2V40.8Ah)	1512Wh (25.2V60Ah)
Life circle	70%@1000cycle	
Charging time	5~6H	7~8H
Charging voltage and current	DC 29.4V9A Solar 36V20(MAX)	
Protection	Over-voltage, low-voltage, over temperature, overload and AC short circuit protection	
Temp	0°C - 45°C (Charge) , -20°C - 45°C (Discharge)	
Size (mm)	L340*W175*H250	
Weight (kg)	11	12.45

Introduction of the parts and its functions

Front Panel

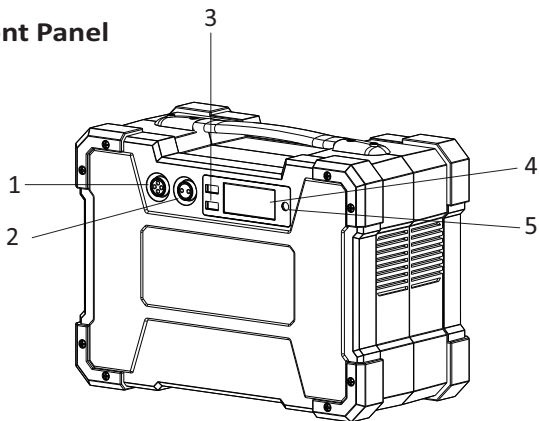

Back Panel

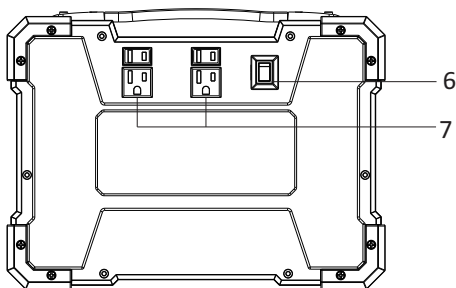

NO.	Description
1	Charging DC 16MF four-pins aviation power socket: (1, 2 is positive, 3, 4 is negative): When the power supply needs to be charged, it can be docked with 16MF four-core aviation plug (IN 29.4-40V10A)
2	DC output 16MF two-core aviation power socket: (1 is positive, 2 is negative): When the DC switch is open, DC power can be supplied (12V10A)
3	USB ports*2 : supply power to electrical appliances with DC 5V(4~9V2A 12V1.5A)
4	Smart display : showing the battery capacity, percentage, power and time of charging and discharging
5	DC output/Power switch : Press this button to view the remaining power of the power unit. At the same time, the display will turn on, as same as the DC output. If need to turn off it, please press it again.
6	AC output switch : AC output will work after pressing it
7	AC outputs : supply 110V output after pressing the AC switch.

Operation instructions and precautions

■ Charge the power unit before using it

To ensure safe transportation of the E1000/E1500 power supply, when you just get the power unit. it is not fully charged or it is in a low battery state, so please charge the power unit before using it.

■ Hint for low battery

When battery is only 10% left, the outline of the battery frame will flash. You should charge the power pack at this time.

■ Use the original charger provided by the manufacturer

In order to ensure the safety of charging, please use the original charger provided by the manufacturer, or use solar panels with 36V 200~300W.

⚠ Warning : Please pay attention the power unit when it's charging. Please disconnect the charger and stop charging when the power is fully charged.

How to charge the power unit

At this stage, we can charge the battery in the following ways:

1. Use our **power adapter** to charge. When charging, we need to plug the end of the power cord into the socket at the end of the adapter. Connect the other end of the adapter to the power charging interface. Connect the other end of the power cable to 110V AC mains, can be charged.

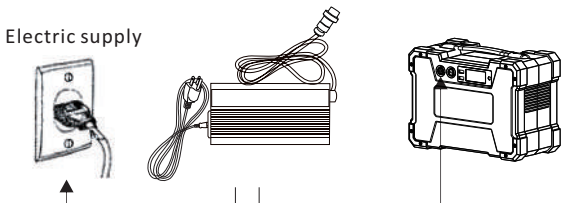

2. Charge the battery with **original car charging cable (optional)**: When you use the car charger, after starting the car engine, you only need to insert the cigarette lighter plug into the car cigarette lighter socket, and then connect the other end of the DC output port with our power unit. Then car charging is working. **Do not use the car charger when the car is not in the starting state.**

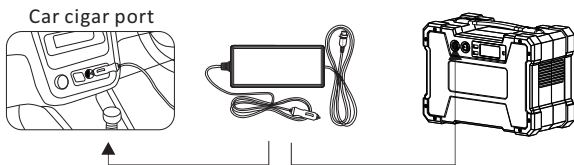

2. Charge the battery with **solar panel**. In this case, it is only necessary to connect one end of the connection cable to the solar panel and the other end to the power charging interface. Then solar charging is working. (maximum voltage of solar panels not more than 40V, minimum voltage not less than 29.4V)

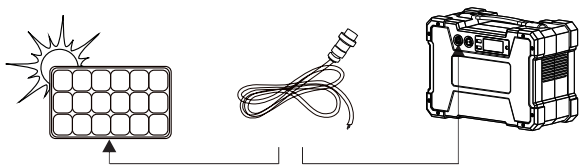

⚠ Warnings :

1. For use only with original power unit and prohibit to be used on other appliances, and prevent rain.
2. When using car charger and solar charging, please pay attention to the connection of positive and negative terminals, prohibit reverse connection.
3. When you leave the portable power supply unused for a long period of time, the battery will run out. Make sure to charge it every 6 months.

How to use AC output

Please note the following before using it:

- 1.The input voltage and frequency of the appliance must be the same as that of the power.
- 2.Please ensure that the rated c of the appliance is less than the rated power of the power supply, preferably within 80% of the rated power.

* The appliance will be damaged once above needs are not met.

* Please choose another portable power pack with higher power once the power of appliances is higher than that of power.



Remarks : since the consumed power of some appliances is greater than its rated power on power-on, the overload protection will occur and power output will turn off. For example, the general starting current for inductive load equipment is up to 3~8 times of its rated power. And its starting power for energy saving lamp is up to dozens of times of its rated power; Their starting power is much more than the instant maximum power that the power pack can bear, so the load protection works automatically. E1500 is featured with overload protection, short-circuit protection, over-temperature protection, over voltage protection and so on.

3.E1000/E1500 will stop working to protect the device once following conditions occur.

- ① When external load exceed the rated power load
- ② AC output or load circuit
- ③ Internal temperature of the device is too high.
- ④ The voltage of the internal battery is too low.

Operating procedures:

Step 1 : Press the AC/DC switch to see the remaining power capacity volume.



Step 2 : Check the working voltage and frequency of the load.

Step 3 : Check the load power and ensure it's not higher than the rated power of E1000/E1500

Step 4 : Plug in the AC socket of E1000/E1500 and turn on the load switch.

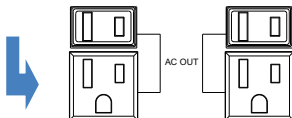

Step 5 : Turn off the AC output switch after using it.

Step 6 : Please charge E1000/E1500 on time if the battery is run off or lack of battery so that you can use it conveniently next time!

 **(Note :** Please be sure to turn off the switch of AC power when you don't need to use it. Or it will be in high energy consume mode, consuming the energy in reserve, which may damage the battery)

How to use DC output



=> DC output 16MF two-core aviation power socket, when the DC output / bright screen switch is pressed, the DC 12V output, its rated current is 10A, and the output is turned off by pressing the button again.



5V/2A



=> USB outlets : Connect the USB cable with your appliances. Then it works automatically.

? Misuse and countermeasures

Error	Root	solution
No display after pressing any switch	Interior battery power out	Charge up
No AC output after pressing the AC switch	Over-temperature	Disconnect the load and start to work it after the temperature is lowered
	Over-load	Check the loading power and decrease it
	Over-voltage	Charge up
No USB output	DC output switch is not open	Press the DC output switch
12V or USB DC consume energy quickly	AC switch is on; standby current is too large	Turn off AC switch during DC output
Not full charged by solar panel	1.The solar panel is not suitable 2.Sunshine is not enough	Choose another solar panel that is much more suitable. And ensure that the charging voltage is higher than 29.4V.

Warranty

The warranty of E1000/E1500 is within 12 months after you buy the product;

During the warranty period, our company will be responsible for the defects on material and process, we will change the damaged parts after receiving them back or maintain the product for free once our technicians inspect that the breakdown occurs normally;

But we are not responsible for the following situations even though it's during warranty period:

- Take apart the product
- Damage on surface coating and appearance.
- Breakdown due to wrong installation, packing and usage.

Customers should do this according to the manual instruction.

- Breakdown or damage caused by accident, man-made and environment(misoperation, crash, unsuitable voltage, damp and etc.)
- Breakdown or damage caused by natural hazard beyond control(earthquake, fire, tsunami and etc.)
- Maintenance is not including package and products accessories;
- We will offer paid service once warranty period is over.

Our company reserves the right to add or delete any maintenance and warranty terms without notice.

The company does not assume any responsibility for any damage to your equipment caused by incorrect use of the company's products. For compatibility of this product with your device, please confirm it with dealer at the time of purchase.

This product specification may change at any time without notice.

Certificate

Item _____

Inspector _____

Date of production _____

Warranty Card

Item _____ Product name _____

Purchasing Date _____ No. _____

Customer _____ Contact _____

Address _____ Receipt No. _____

Distribute _____ Address _____

Statement for poisonous and harmful substance of the power unit

Parts	Poisonous and harmful material and elementd					
	(pb)	(Hg)	(Cd)	(Cr6+)	(PBB)	(PBDE)
Structuralpa parts	x	o	o	o	o	o
Circuit board	x	o	o	o	o	o
Adapter	x	o	o	o	o	o
Cables	x	o	o	o	o	o
Connector	x	o	o	o	o	o
Accessory	x	o	o	o	o	o

1. "o" indicates that the content of this toxic and hazardous substance in all homogeneous materials of this part is below the limit requirement specified in SJ/T11363-2006.
2. "x" indicates that the hazardous substance contains at least a certain amount of the homogeneous material specified in the SJ/T11363-2006 standard.
3. Since there is no exemption from the Chinese limit standard, the mark "x" does not necessarily mean that it is harmful to the human body.
4. For products manufactured, these European exempt substances may be included.
5. All parts may or may not be included in the item being sold.



This environmental protection period applies only to products that work under the conditions specified in the user manual.

Copyright

This user manual is protected by international copyright laws. No part of this manual may be reproduced, distributed, translated or transmitted in any form or by any means (electronic or mechanical), including photocopying, recording or storing in any information storage and retrieval without the prior written permission of the company. Due to product version upgrades or other reasons, the content of this manual may be updated from time to time. Unless otherwise agreed, this manual only serves as a guide to use. All statements, information, and suggestions in this manual do not constitute any express or implied warranty.

■ Some of the instructions in the manual may not exactly match the device, depending on the device software and service provider.

■ Power unit and accessories may differ from the icons in this manual, depending on country in which the power unit will be used.

■ The maximum electromagnetic radiation specific absorption rate (SAR) of this product is 0.309 W/kg, which meets the requirements of the national standard GB 201288-2007.