

MU04

4" Monitoring Unit

About

The MU04 is designed to automate the process of water quality monitoring, through the use of apparatus that continuously records and reports the quality downstream of a certain point, most commonly at the final site discharge point.

At the core the system is a range of standard equipment brought together into an effective package to deliver maximum results and guarantee compliance, through the transmission of data to the leading-edge User Interface and warning alert system.

The MU system is a simple way to give ultimate peace of mind about the compliance of your sites, ensuring that you never fail to comply with the authority's requirements for water standards.

How it Works

The MU04 unit is situated in the pipeline at the chosen point and using the probes or water meter onboard, monitors the water quality as it passes that particular point. The data is then interpreted by our unique Control Module the CM01, which transmits this data to the EnviroHub User Interface, where it is logged and presented to you in various formats.

Using the MU04 in conjunction with our User Interface means both historic and real-time data can be viewed anywhere and at anytime and files downloaded in PDF format. The system, as continually reading the water quality, will send a text or email alert message to site operatives when a permit constraint is approached or met, giving time for corrective action to be taken.

Depending on how the system is set up, when a constraint is met, it will send control signals to activate a valve or switch a pump on/off to save operatives needing to be on site, but always ensuring site's compliance.



Features

- Suitable for all water types
- Can monitor a wide range of parameters including pH, turbidity and flow
- Self-contained and elevated above ground level for protection of equipment
- Apparatus protected from elements
- Very fast to deploy
- Very low power requirement
- Works in very poor radio connectivity areas
- Easy access for cleaning and maintenance

Benefits

- Removes human error and monitors continuously
- Provides 24/7 365 data logs for onsite water activity to prove compliance
- Monitored from anywhere at any time
- Automated process and warning alerts of potential breaches before they happen
- Options for full system integration and control
- Good practice for Environmental care
- Ensures compliance with Authority requirements

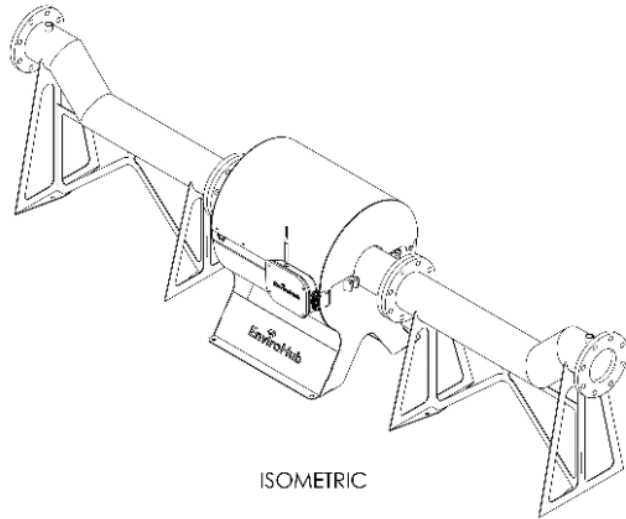

General Arrangement Drawings

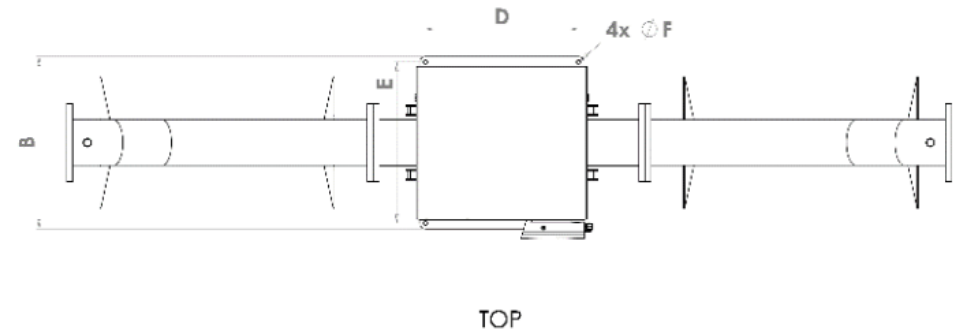

Layout Drawings

Value	MU04	Unit
Mass (Empty)	160	kg
Flanges	DN100 PN10	-
A	2564	mm
B	578	mm
C	900	mm
D	444	mm
E	553	mm
F	15	mm

