

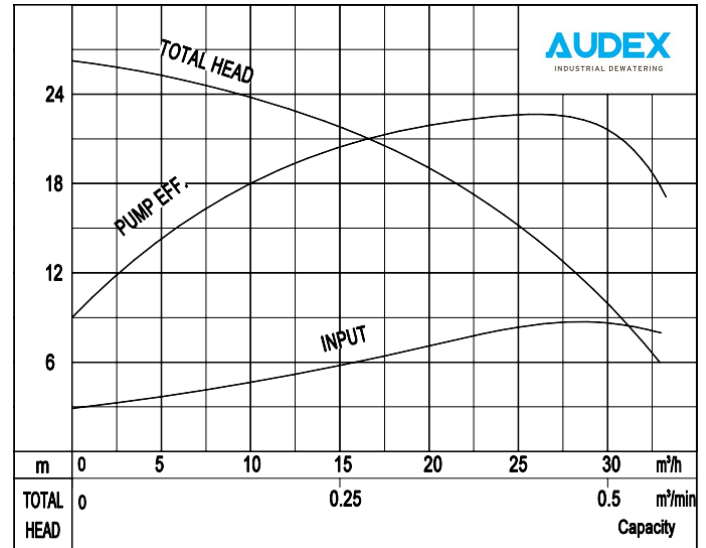

Pump Curve



Overview

- Rigid cast iron body and motor for long lasting durability.
- A greatly increased maximum submersion depth due to the mechanical seal being resistant to high pressure.
- A semi-open impeller made of high chrome alloy and a wear plate made of ductile iron.
- Effective motor cooling due to discharge channel cast as part of the motor housing.
- Top outlet allowing the user to submerge the pump in a confined area.

Applications

- Civil engineering
- Mines, quarries, coal mine & slurries
- Sewage treatment plants
- General pumping purposes

About Audex

Audex are respected manufacturers of industrial submersible and vac-prime self-priming dewatering pumps. Our pumps have been specifically developed for use in the toughest and most abrasive of applications and environments. Trusted by operators of quarries, mines and recycling facilities, Audex pumps represent quality and reliability giving you superior performance and reduced downtime. Pumps that suit your application better because they have been designed with your industry in mind.

Specification

Model	AS 2-220 TC
Outlet	50mm
	2"
Hertz	50
Volts	415
Motor Power	2.2kW
Max Head	26m
Max Capacity	33m ³ /h
	0.55m ³ /min
Rated Current (400V)	5.0A
Impeller Passage	8.5mm
Max Water Temperature	40°C
Cable Length	10m
DOL Start Size	8kVA
Soft Start Size	4kVA
VSD Starting	4kVA
Net Weight (N.W)	39kg
Gross Weight (G.W)	43kg
Packing Dimension	610 x 265 x 275mm
Product Code	P14189

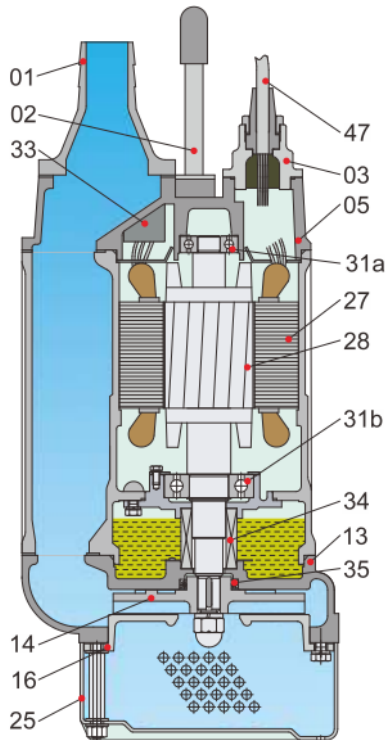

Materials of Construction

Item No.	Part name	Material
1	Hose coupling	Cast iron
2	Handle	Rubber and steel
5	Upper cover	Cast iron
11	Motor body	Cast iron
13	Pump body	Cast iron
14	Impeller	High chrome alloy
16	Inlet plate	Ductile iron
25	Strainer	Steel
27	Stator	
28	Rotor	Shaft: AIS1420SS
31a	Bearing	Ball bearing
31b	Bearing	Ball bearing
33	Motor protector	
34	Mechanical seal	Sic-Sic/Carbon-Sic(≤2.2kW) Sic-Sic/Sic-Sic(≥3.7kW)
35	Oil seal	
47	Cable	

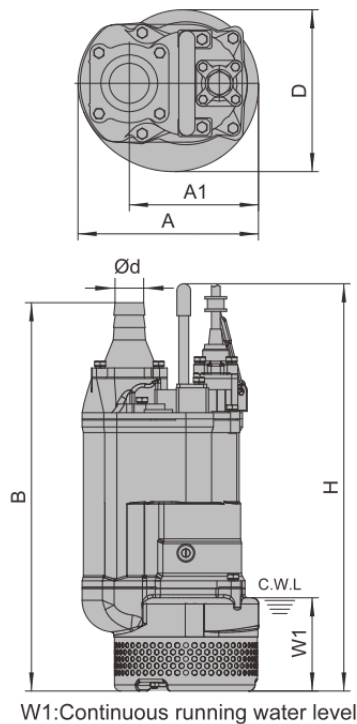

Dimensions

d (mm)	50
A (mm)	235
A1 (mm)	173
B (mm)	535
D (mm)	216
H (mm)	505
W1 (mm)	120
Packing dimensions (mm)	610 x 265 x 265

C.W.L Continuous running water level