

HEX

Instructions and Safety Manual



Read and follow all safety warnings and instructions in this manual.

Retain instructions and safety manual for future reference.

HEX CROSSBOW INSTRUCTION MANUAL

Thank you for the purchase of your new HEX crossbow! This crossbow has been engineered to be high speed and lightweight. It has been designed, manufactured and tested for safety and performance when used in accordance with the instructional materials provided. Before you begin the assembly of your crossbow, please check and make sure the following components and accessories are fully included in the box.

- 1. Crossbow Body (assembled back end)**
- 2. Assembled Riser (assembled front end)**
- 3. Quick Detach Quiver**
- 4. Quiver Mounting Hardware Pack / Lubewax**
- 5. Assembly Hardware Pack**
- 6. Rope Cocker**
- 7. 3 x 20" Carbon bolts / 125 grain practice points**
- 8. 4 x 32 Scope**
- 9. Foot Stirrup**
- 10. Shoulder Sling (optional)**

If any of the components / accessories are missing, please contact your local dealers for assistance.

Crossbow Diagrams

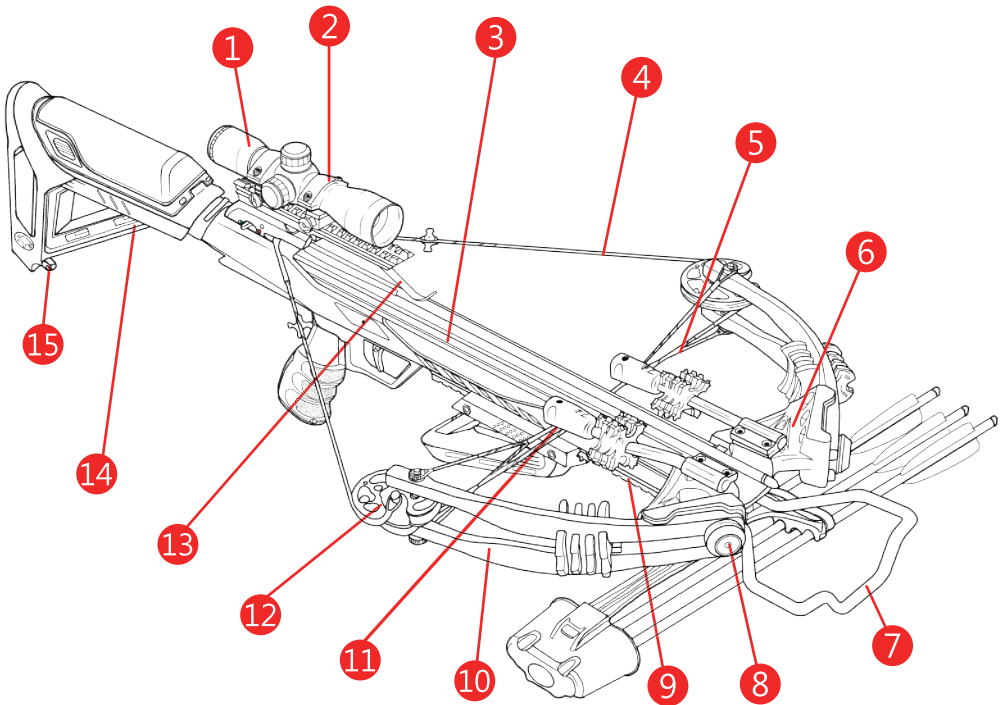

- | | |
|------------------|------------------------------------|
| 1. Scope | 9. Picatinny Rail |
| 2. Scope Mount | 10. Limbs |
| 3. Rail / Barrel | 11. Cable Slide |
| 4. String | 12. Cam |
| 5. Cable | 13. Crossbow bolt Retention Spring |
| 6. Riser | 14. Stock |
| 7. Foot Stirrup | 15. Sling stud |
| 8. Limb Bolt | |

Assembly Guide

1

- Position the front end on a flat surface as shown in the diagram. Four screw holes should now face upward.
- Identify two grooves on the cable slide, one groove is deeper than the other.
- Noticing the cables run across each other forming an "X" shape.
① → ② Attach the **deeper groove** of the cable slide to the **lower cable** from the underside. Slowly move the cable slide towards the cross section of the cables and ensure the upper cable and lower cable sit firmly in the grooves.

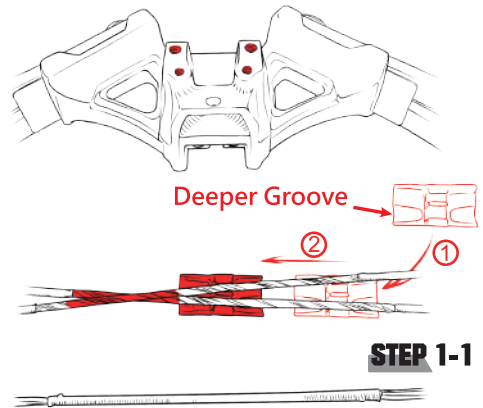

2

Lubricate and insert the cable slide under the rail.

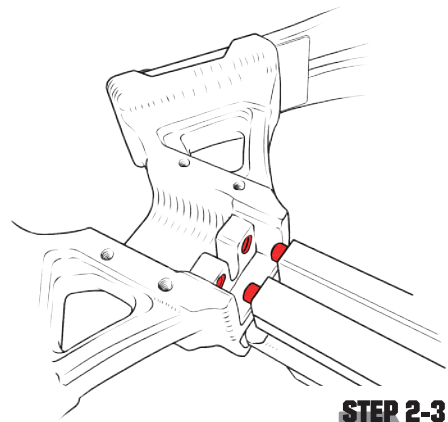
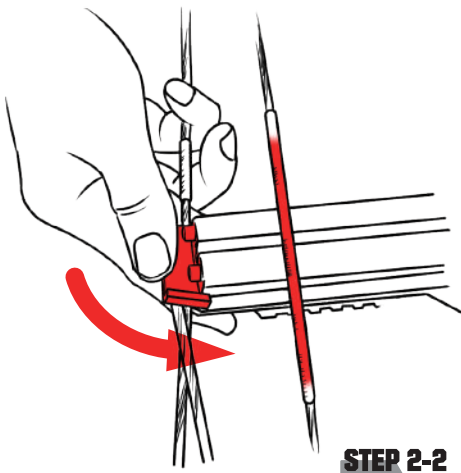
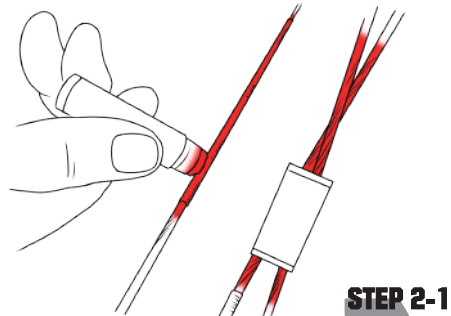

3

Assemble the riser onto the barrel by using the bolts as shown after the cable slide and bowstring are properly positioned. Turn the riser and tighten the screw at the back.

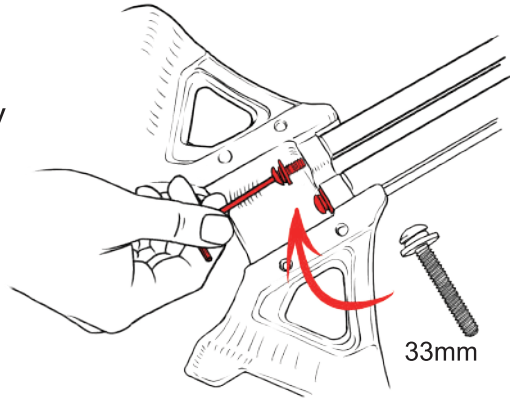

STEP 3-1

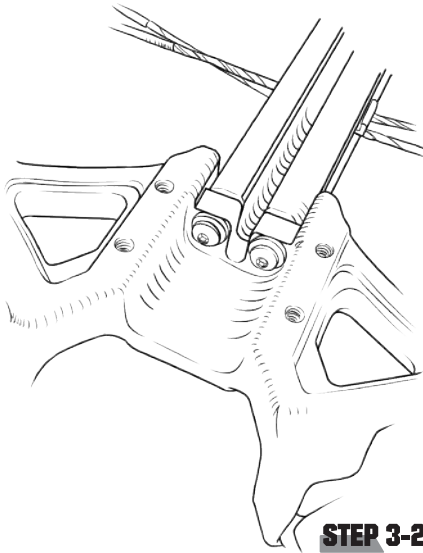

STEP 3-2

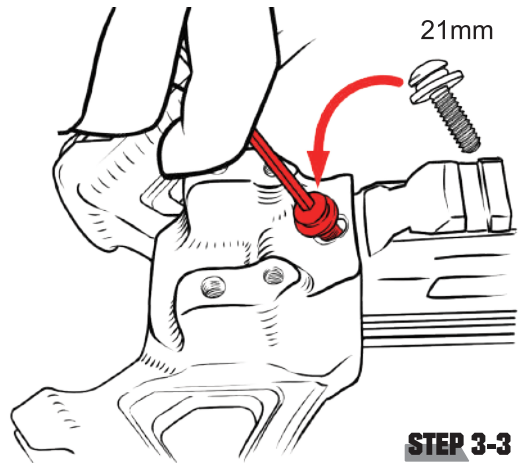

STEP 3-3

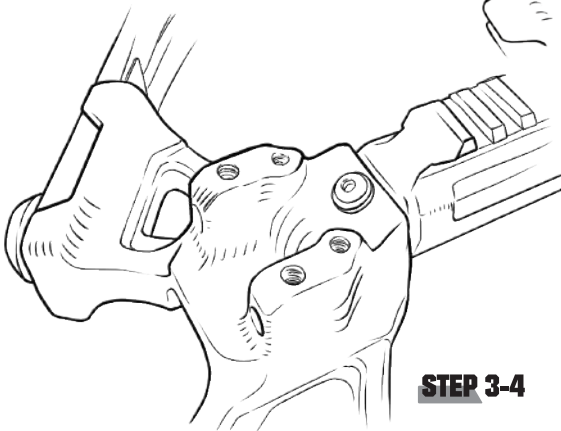

STEP 3-4

4

Attach the foot stirrup to the riser with the screws provided as shown.

● Be sure that the bow unit is secured tightly before engaging crossbow. Assembly bolts may need to be retightened periodically after use.

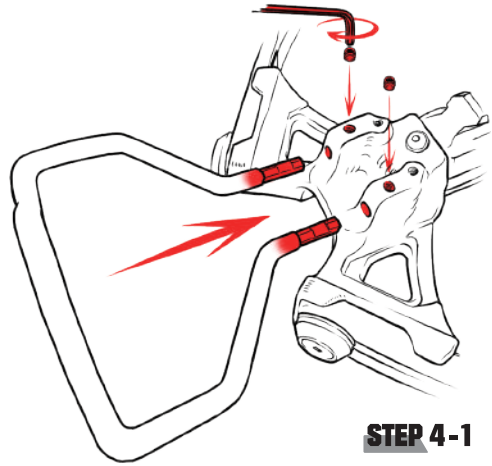

STEP 4-1

5

Attach the quiver mounting bracket onto the back of the riser by the screws provided. Position the bracket by tightening the screws. Check your quiver mounting hardware pack for the components and hardware. Then attach the quiver onto the bracket.

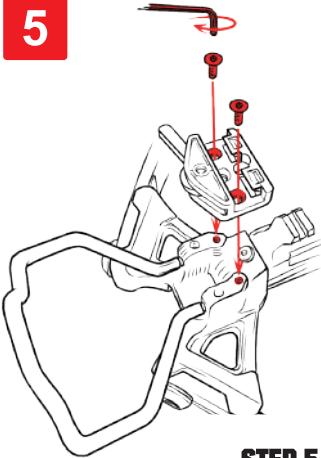

STEP 5-1

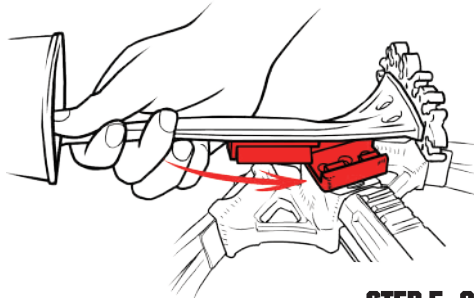

STEP 5-2

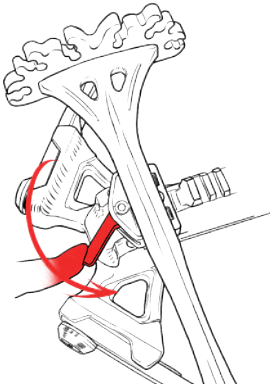

STEP 5-3

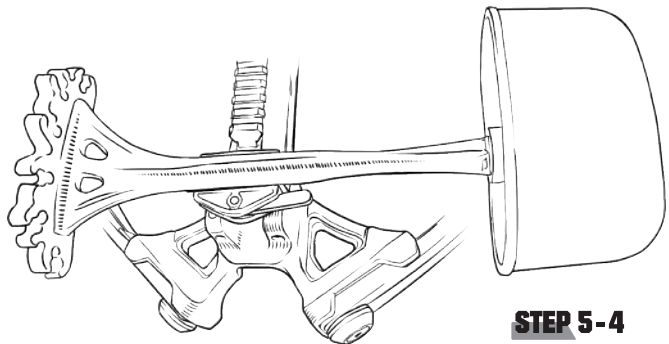

STEP 5-4

6

Position your scope by moving it forward or backward until the proper eye relief is found. This is typically three or four inches from your eye to the eyepiece when you are holding the crossbow in a shooting position. Tighten the scope mount rings by hand or with a coin.

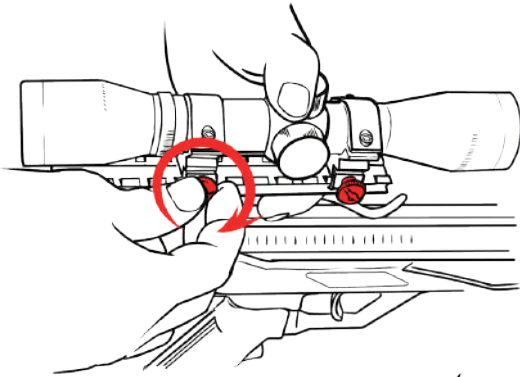

STEP 6-1

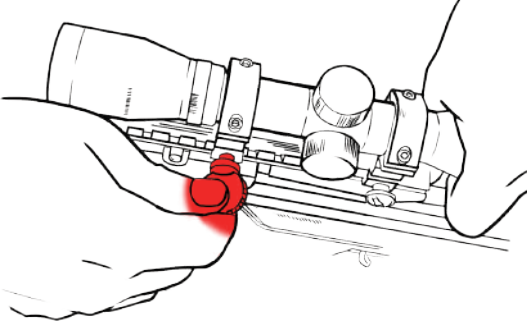

STEP 6-2

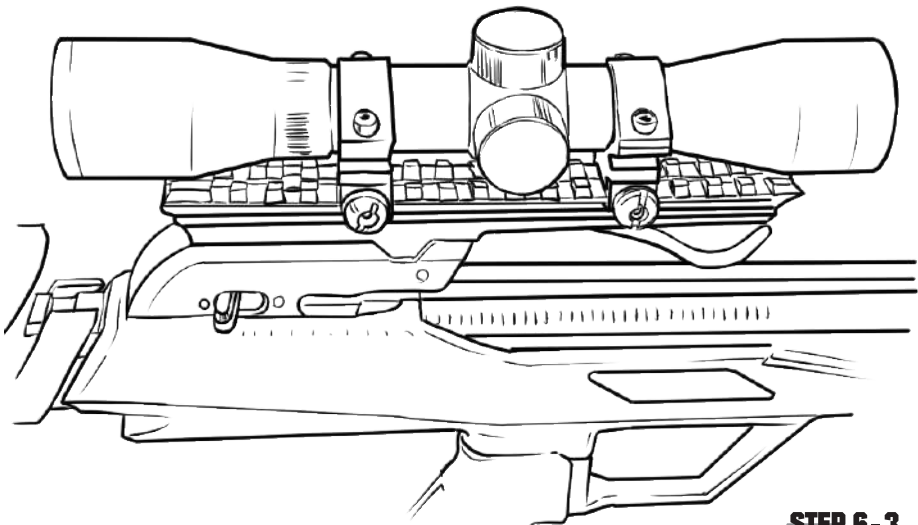

STEP 6-3

7

(Optional) If you purchase the product with a shoulder sling: Attach the shoulder sling to the sling studs. Loosen the spring loaded thumb screw on the swivel and then press it to unlock the latch. Hook it onto the stud under the stock and then tighten down the thumb screw to secure the latch.

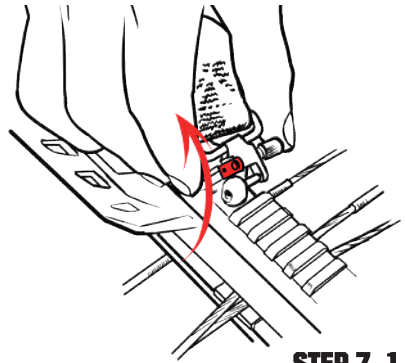
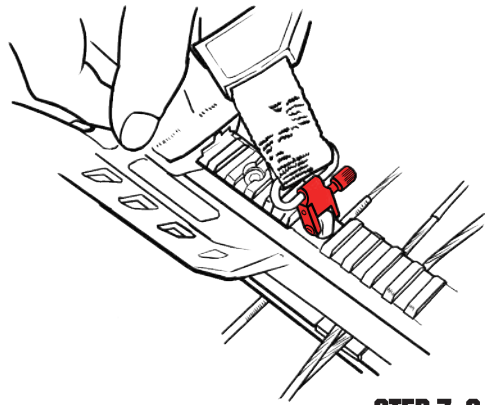
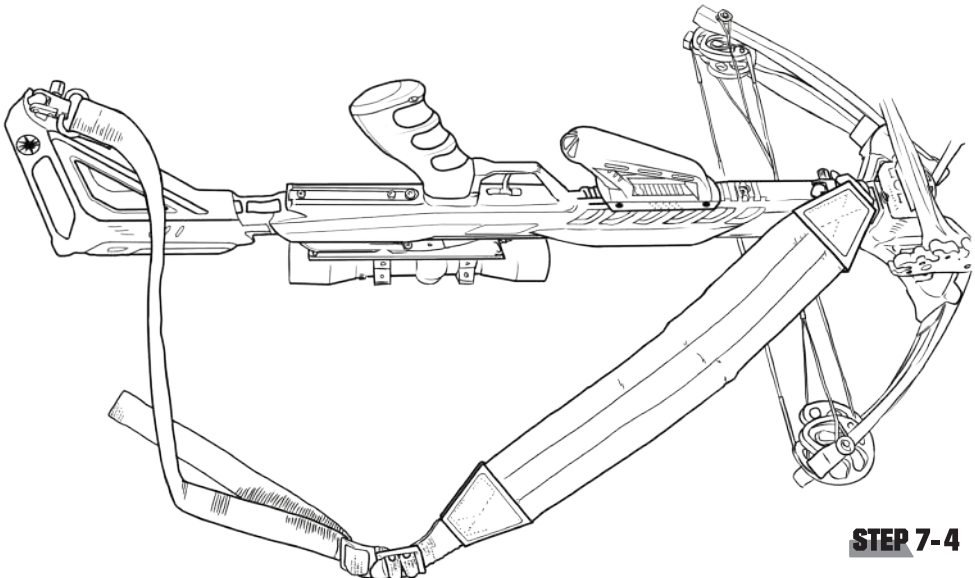
**STEP 7-1****STEP 7-2****STEP 7-3****STEP 7-4**

Crossbow Operation

1

Using the rope cocker

- Be sure to apply the lubewax to the string including the center serving, cables and the flight track before cocking.
- Make sure the trigger's safety is in the "Fire" position before cocking your crossbow, otherwise the string latch will not engage or hold the bowstring. Place the trigger safety into the "Fire" position, and then place the center of the coking rope in the rope groove. Set the foot stirrup on the ground with one foot in the stirrup and stock end resting against your thigh. For the maximum pull force, place the cocker hooks up, not hooks down, then pull with even force. Be sure the hooks must stay against the flight rail during cocking operation. Pull the rope until it locks into the trigger mechanism with an audible click and the safety is back in the "Safe" position. The crossbow is now cocked, ready for loading. Do not use your hand or the rope cocker to uncock the crossbow as it may cause serious injury to the user or damage to the crossbow.

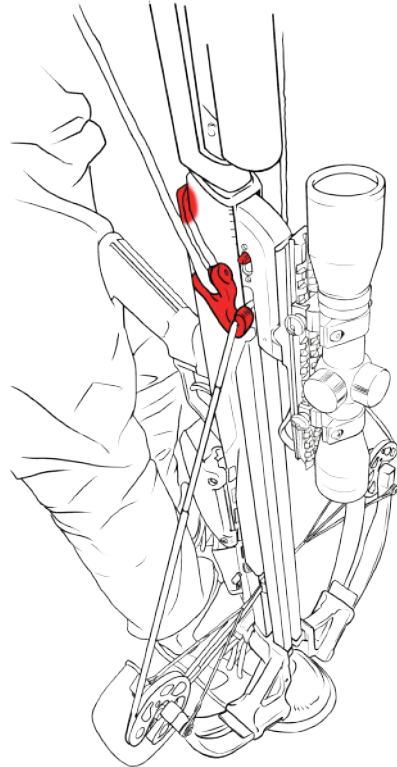
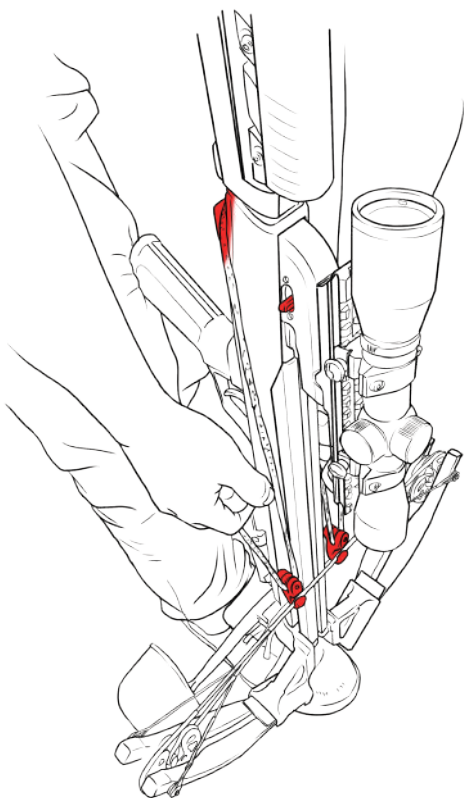

2

Loading the bolt

Place the bolt odd colored fletch in the flight groove and the half moon shaped nock is parallel to the string. Slide the bolt under the retention spring and fully into the trigger mechanism against the string. Switch the trigger safety to "Fire" position again and you are now ready to aim and shoot.

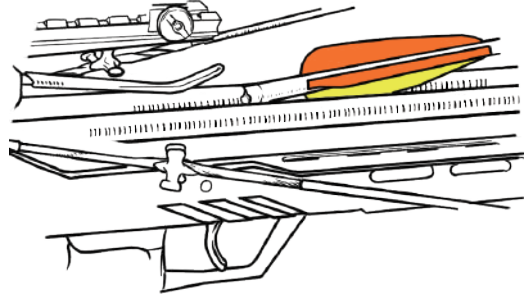

WARNING

To avoid any injuries to yourself or others, or damage to your crossbow, the following safety instructions should be followed at all times

- Never allow your fore-grip hand's fingers or thumb to move above the barrel's flight deck or into the bowstring or cables' release path. Keep your hand fingers in a safe position every time you shoot the crossbow. Placing your hands, fingers, thumbs or other body parts in the path of the bowstring or cables may cause serious injury.

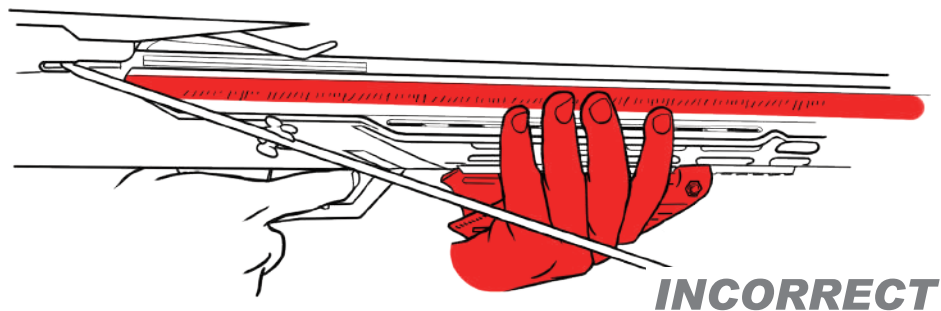
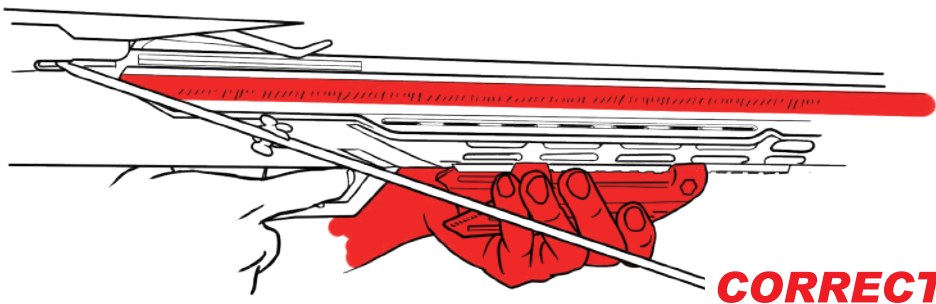

Safety Instructions

- Always make sure the risers bolts / screws are securely tightened before using.
- Never allow your fingers or thumb to move above the barrel's flight deck and keep out of the path of cables and string while holding the fore-grip.
- Never **dry-fire** the crossbow. Shooting without a crossbow bolt is damaging to the crossbow. **Dry firing will void the warranty** and can result in damage to the limbs, string and cables possibly causing personal injury.
- Always inspect the crossbow equipment for warn, loose, damaged or missing parts. Replace if any missing, fraying or damaged parts are observed or suspected.
- Always point your crossbow in a safe direction and keep the crossbow out of the reach of children.
- Do not remove or deactivate your crossbow's safety features or accessories, potentially rendering the crossbow dangerous to you or others.
- Always make sure the crossbow bolt is fully seated in furthest back position to reduce possibility of dry fire.
- Replace strings and cables if visible signs of fraying or broken strands are evident.
- Do not transport or store your crossbow while it is cocked or loaded.
- Do not attempt to use your crossbow under the influence of alcohol, prescription or non-prescription drugs.
- Always use suitable crossbow bolts / arrows. Arrows / Bolts of improper stiffness or mass weight may damage the limb and cableassembly voiding the warranty and possibly causing personal injury.
- When practice shooting, wear eye protection and be sure your range is located in a spacious area free of buildings and your target is designed for crossbow use.

Maintenance And Care

1. Apply lubewax to the string and cables liberally. Do not over lubricate the center section of the crossbow string as this may cause a build up of lubricant in the trigger mechanism. Keep the flight track and the string serving waxed to reduce friction. Always check and replace frayed or worn strings and cables.
2. Periodically put a few drops of high quality machine oil in the trigger mechanism, cams and axles.
3. Always store your crossbow in a cool, dry place. Do not expose your crossbow to excessive heat such as leaving it in an automobile trunk on a hot day or storing it next to a furnace vent.
4. Before each shooting session, examine all bolts and fasteners. Tighten all bolts as needed. CAUTION: Limb bolts are preset for proper balance and weight at the factory. Do not adjust limb bolts.
5. Be sure to have your crossbow examined annually by a qualified crossbow dealer.
6. Do not leave your crossbow cocked for extended periods of time or overnight.

Warranty Information

Subject to the terms, conditions and limitations outlined below, we guarantee 1 year warranty service to the original purchaser for our crossbows against defects in materials and workmanship that adversely affect the crossbow's operation. However, crossbow strings, cables, cable slides, sleeve bushings, bearings, cosmetic appearance and component parts and those which are subject to a variety of conditions in normal use and considered to be consumable parts will be excluded.

This limited warranty will be void if the following occur :

- Damage is caused by dry-firing or by using underweight arrows / bolts
- The instructions in the owner's manual are not followed
- The crossbow or any of its parts or accessories are altered from their original state
- The crossbow has not been maintained properly
- Failure or damage was caused by improper calibration or by abnormal use.

Please carefully package and return the product, transportation charges pre-paid to your dealers or distributors. All accessory items must be removed from the crossbow prior to shipping. If after examining a returned product, the dealer determines that the product is not subject to this limited warranty, product repairs can be provided at then-current repair rates informed by the dealer.

Warranty Registration must be mailed within 10 days of purchase to validate the warranty.

Dealer's contact information :

Model Number/Name

Date of Purchase

Purchaser's Name

Address

City

State

Zip Code

Email

Phone Number

